



**POLYMET**  
MINING

**NorthMet Project**  
**Waste Characterization Data Package**

**Version 12**

**Issue Date: February 13, 2015**

This document was prepared for Poly Met Mining Inc. by  
Barr Engineering Co.



Date: February 13, 2015	NorthMet Project Waste Characterization Data Package
Version: 12	Page i

**Table of Contents**

1.0 Introduction..... 1

    1.1 Outline..... 1

2.0 Regulatory Basis..... 2

3.0 Overburden..... 3

    3.1 Reports..... 3

        3.1.1 Initial Report.....3

        3.1.2 2011 Update.....5

    3.2 Overburden Management Concept..... 5

4.0 Waste Rock..... 7

    4.1 Reports..... 7

        4.1.1 Initial Report.....7

        4.1.2 2009 Update.....9

        4.1.3 2011 Update.....11

            4.1.3.1 2011 Geochemical Update.....11

            4.1.3.2 Category 1 Concentration Caps Study.....12

        4.1.4 2012 and 2014 Humidity Cell Trends Updates.....15

    4.2 Waste Rock Management Concept..... 15

    4.3 Waste Characterization Program as Applied to Waste Rock Stockpiles..... 16

        4.3.1 Waste Characterization by Geologic Unit and Rock Type.....16

            4.3.1.1 Combination of Units 2 & 3 and 4 & 5.....16

            4.3.1.2 Unit 7.....17

        4.3.2 Sulfur Content of Stockpiles and Pit Walls.....23

5.0 Flotation Tailings..... 31

    5.1 Reports..... 31

        5.1.1 Initial Report.....31

        5.1.2 2009 Update.....32

        5.1.3 2011 Update.....34

            5.1.3.1 Depositional Study.....34

            5.1.3.2 2011 Geochemical Update.....39

            5.1.3.3 2011 Humidity Cell Trends Update.....39

        5.1.4 2012 and 2014 Humidity Cell Trends Updates.....40

    5.2 Flotation Tailings Management Concept..... 41



Date: February 13, 2015	NorthMet Project Waste Characterization Data Package
Version: 12	Page ii

6.0	Hydrometallurgical Residue .....	42
6.1	Reports.....	42
6.1.1	Initial Report.....	42
6.1.2	2009 Update .....	44
6.1.3	2011 Design Update .....	44
6.1.4	2013 Water Quality Update.....	44
6.2	Hydrometallurgical Residue Management Concept.....	46
7.0	Geochemical Parameters – Overburden.....	47
7.1	Leachate Water Quality – Unsaturated Overburden .....	47
7.2	Leachate Water Quality – Peat.....	47
7.3	Leachate Water Quality – Saturated Overburden.....	49
8.0	Geochemical Parameters – Waste Rock .....	50
8.1	Laboratory Release Rates.....	50
8.1.1.1	Sulfate Release Rates for Category 1, Category 2/3 and Ore.....	50
8.1.1.2	Linear Regression Analysis .....	50
8.1.1.3	Combining Data Sets .....	54
8.1.1.4	Testing Assumptions of Ordinary Least Squares.....	55
8.1.1.5	Correction for Non-Constant Variance.....	56
8.1.1.6	Application to Probabilistic Modeling.....	59
8.1.2	All Other Release Rates .....	60
8.1.2.1	Release Rates from Humidity Cells.....	61
8.1.2.2	Release Rates from Humidity Cell Release Ratios.....	63
8.1.2.3	Release Rates from Solid Ratios.....	63
8.1.2.3.1	Nickel Release .....	65
8.2	Lab to Field Scale-Up.....	66
8.2.1	Background .....	66
8.2.2	Water Contact Factor.....	68
8.2.3	Particle Size Factor.....	68
8.2.4	Temperature Factor .....	71
8.2.5	Acidity Factor.....	74
8.2.6	Composite “Bulk” Scale-Up Factor .....	77
8.2.7	Scale-Up Model Verification .....	79
8.2.8	MDNR Method for Category 1 Waste Rock Stockpile Scale-Up.....	81



Date: February 13, 2015	NorthMet Project Waste Characterization Data Package
Version: 12	Page iii

8.3	Concentration Caps .....	83
8.3.1	Category 1 Waste Rock .....	83
8.3.1.1	Category 1 Waste Rock Stockpile pH .....	83
8.3.1.2	Concentration Caps from Category 1 SMWMP Study .....	86
8.3.1.3	Concentration Caps from Modeled Mineral Solubility .....	87
8.3.1.4	Concentration Caps from Analog Site Data .....	88
8.3.1.5	Concentration Caps Dependent on pH (PolyMet method) .....	89
8.3.1.6	Concentration Caps Dependent on pH (MDNR method) .....	91
8.3.2	Duluth Complex Category 2/3/4 Waste Rock and Ore (nonacidic) .....	92
8.3.3	Duluth Complex Category 2/3/4 Waste Rock and Ore (acidic) .....	93
8.3.4	Virginia Formation Category 4 Waste Rock .....	93
8.4	Additional Model Parameters and Considerations .....	93
8.4.1	Depletion .....	93
8.4.2	Nitrogen in Waste Rock .....	95
8.4.3	Ore Spillage from Rail Cars .....	100
8.4.4	Chloride Release from Waste Rock .....	104
9.0	Geochemical Parameters – Pit Lake .....	106
9.1	Laboratory Release Rates .....	106
9.2	Mass of Reactive Wall Rock .....	106
9.3	Lab to Field Scale-Up .....	107
9.3.1	Water Contact Factor .....	108
9.3.2	Particle Size Factor .....	108
9.3.3	Temperature Factor and Solar Heating .....	109
9.3.3.1	Solar Radiation .....	110
9.3.3.2	Atmospheric Radiation .....	111
9.3.3.3	Reflected Solar Radiation .....	112
9.3.3.4	Emitted Radiation .....	112
9.3.3.5	Convective Heat Transfer .....	112
9.3.3.6	Heat Conducted into Wall .....	112
9.3.3.7	Wall Surface Temperature Increase .....	113
9.4	Acidification and Long-Term Decay in Constituent Release .....	115
9.5	Concentration Caps .....	121
9.5.1	Pit Walls .....	121
9.5.2	Pit Backfill and Pit Lake .....	122



Date: February 13, 2015	NorthMet Project Waste Characterization Data Package
Version: 12	Page iv

9.6	Additional Model Parameters and Considerations .....	122
9.6.1	Age of Pit Walls .....	122
9.6.2	Backfill Modeling Parameters .....	123
9.6.3	Nitrogen in Mine Pits .....	123
9.6.4	Subaqueous Oxidation .....	124
9.6.5	Dewatered Material Oxidation .....	126
10.0	Geochemical Parameters – Flotation Tailings .....	128
10.1	Laboratory Release Rates .....	128
10.1.1	Flotation Tailings .....	128
10.1.1.1	Release Rates from Humidity Cells .....	128
10.1.1.2	Release Rates from Solid Ratios .....	129
10.1.1.3	Release from Concentration Caps .....	130
10.1.2	LTVSMC Tailings .....	130
10.1.2.1	Release Rates .....	131
10.1.2.2	Release from Concentration Caps .....	131
10.1.2.3	Flushing Load .....	132
10.2	Lab to Field Scale Up .....	132
10.2.1	Scaling / Calibration to LTVSMC Field Data .....	134
10.3	Saturation and Oxygen Diffusion .....	140
10.3.1	Unsaturated Flow .....	141
10.3.2	Hydraulic Parameters for Flotation Tailings .....	142
10.3.2.1	Expected Saturation Levels of the FTB Dams and Beaches .....	147
10.3.2.2	Expected Saturation Levels Below the FTB Pond .....	148
10.3.3	Hydraulic Parameters for LTVSMC Tailings .....	150
10.3.4	Oxygen Diffusion .....	151
10.4	Concentration Caps .....	154
10.5	Flotation Tailings/LTVSMC Tailings Interaction .....	155
10.6	Additional Model Parameters .....	156
10.6.1	Oxidation of Saturated Tailings .....	156
10.6.2	Tailings Weathering .....	159
10.6.3	Process Water Loading to Pond .....	159
10.6.3.1	Ore Leaching Load .....	159
10.6.3.2	Reagent Load .....	160



Date: February 13, 2015	NorthMet Project Waste Characterization Data Package
Version: 12	Page v

10.6.4 Effects of Re-suspension by Wind .....	160
10.6.5 Buttress Material .....	161
10.6.6 Depletion .....	161
11.0 Geochemical Parameters – Hydrometallurgical Residue .....	163
Revision History .....	164
References.....	167
List of Tables .....	171
List of Figures.....	173
List of Large Tables.....	175
List of Large Figures.....	176
List of Attachments.....	178



Date: February 13, 2015	NorthMet Project Waste Characterization Data Package
Version: 12	Page 1

## 1.0 Introduction

This document presents the waste characterization data used by the Rock and Overburden, Flotation Tailings and Residue Management Plans, and for the water quality impact modeling presented in the NorthMet Water Modeling Packages (Volumes 1 and 2). In this document, Flotation Tailings are the NorthMet bulk flotation tailings, the Tailings Basin is the existing former LTV Steel Mining Company (LTVSMC) tailings basin, and the Flotation Tailings Basin refers to the Tailings Basin with the NorthMet basin. In addition, the Flotation Tailings Basin is designated FTB.

In cases where a supporting document is referenced, a general description of the supporting document is provided.

### 1.1 Outline

The outline of this document is:

- Section 2 Describes the regulatory basis for the waste characterization data.
- Section 3 Describes the data for waste characterization of overburden.
- Section 4 Describes the data for waste characterization of waste rock and wall rock.
- Section 5 Describes the data for waste characterization of tailings.
- Section 6 Describes the data for waste characterization of residue.
- Section 7 Describes the geochemical parameters for modeling overburden.
- Section 8 Describes the geochemical parameters for modeling waste rock.
- Section 9 Describes the geochemical parameters for modeling the pit lake.
- Section 10 Describes the geochemical parameters for modeling tailings.
- Section 11 Describes the geochemical parameters for modeling residue.

This document is intended to evolve through the environmental review, permitting, operating and closure phases of the NorthMet Project (Project). A Revision History is included at the end of the document and the most recently updated sections are highlighted in gray.



Date: February 13, 2015	NorthMet Project Waste Characterization Data Package
Version: 12	Page 2

## 2.0 Regulatory Basis

Minnesota Rules, part 6132.1000 requires characterization of mine wastes from non-ferrous mining projects as part of the Permit to Mine process. The project proposer must meet with the Minnesota Department of Natural Resources (MDNR) staff to outline chemical and mineralogical analyses and laboratory tests to be conducted for mine waste characterization.

Poly Met Mining Inc. (PolyMet) met with the Lands and Minerals Division of the MDNR in 2004 and 2005 to develop waste characterization test plans that included chemical analysis of the mine waste, mineralogical/petrological analysis of the mine waste and laboratory tests describing acid generation and dissolved solids release from the mine waste. The tests were performed on material generated by exploration, preproduction sampling and process testing. The mine waste characterization has been conducted by SRK which has demonstrated proficiency in such analysis and was approved by the MDNR.

Requirements for the management of reactive mine waste are described in Minnesota Rules, part 6132.2200. The rule's objective is to prevent the release of substances that result in adverse impacts on natural resources. Per the rule, a generator of reactive mine waste must either:

- modify the physical or chemical characteristics of the mine waste, or store it in an environment, such that the waste is no longer reactive; or
- during construction to the extent practicable and at closure, permanently prevent substantially all water from moving through or over the mine waste and provide for the collection and disposal of any remaining residual waters that drain from the mine waste, in compliance with federal and state standards.

Overburden will be managed as a reactive mine waste. See Section 3.2 for a description of the mine waste management concept.

Waste Rock will be managed as a reactive mine waste. See Section 4.2 for a description of the mine waste management concept.

Flotation Tailings will be managed as a reactive mine waste. See Section 5.2 for a description of the mine waste management concept.

Hydrometallurgical Residue will be managed as a reactive mine waste. See Section 6.2 for a description of the mine waste management concept.





Date: February 13, 2015	NorthMet Project Waste Characterization Data Package
Version: 12	Page 3

### **3.0 Overburden**

The purpose of waste characterization for overburden is to determine the geochemical characteristics of the overburden generated by the Project and use those characteristics to develop a general overburden management concept.

#### **3.1 Reports**

##### **3.1.1 Initial Report**

The initial report (Reference (1)) was submitted in 2008. A summary of the report is presented in the following paragraphs.

The results of initial chemical testing (37 samples) and leaching testing (14 samples) of NorthMet overburden were integrated with knowledge of glacial movement to develop an overall classification of the overburden:

- Saturated Overburden – overburden that has remained below the water table and has not been oxidized and can release metals when exposed to air and oxidized
- Unsaturated Overburden – overburden that has been above the water table and has been oxidized so that metals have already been released
- Peat – organic material that will not release metals associated with sulfide minerals but can release mercury

The leach testing results were used to develop reasonable worst case (95th percentile) contact water chemistry information for constituents from each class of overburden. The reasonable worst case contact water concentrations are presented in Table 3-1.

An updated report (Reference (2)) was submitted in 2010. A summary of the report is presented in the following paragraph.

Additional samples were collected and the results of leach testing were used to reassess the reasonable worst case contact water chemistry for constituents from Unsaturated Overburden. The additional data confirmed the characterization of the Unsaturated Overburden throughout the site, as shown by the comparison of reasonable worst case contact water chemistry in Table 3-2.

**Table 3-1 95th Percentile Results from Overburden Leaching Tests**

Constituent	Units	Peat	Mineral Overburden	
			Saturated	Unsaturated
pH		6.9	4	6.9
Alkalinity	mg CaCO <sub>3</sub> /L	79	36	12
Fluoride	mg/L	1	0.56	0.45
Chloride	mg/L	8.8	3.8	3.4
Sulfate	mg/L	92	210	15
Aluminum (Al)	mg/L	0.13	0.63	0.3
Antimony (Sb)	mg/L	0.00069	0.0012	0.00098
Arsenic (As)	mg/L	0.0043	0.0028	0.0029
Barium (Ba)	mg/L	0.034	0.026	0.013
Beryllium (Be)	mg/L	<0.0002	0.00055	<0.0002
Boron (B)	mg/L	0.23	0.087	0.028
Cadmium (Cd)	mg/L	<0.00004	0.005	0.00015
Calcium (Ca)	mg/L	23	26	5.7
Chromium (Cr)	mg/L	0.00094	0.0012	0.00097
Cobalt (Co)	mg/L	0.00066	0.23	0.0015
Copper (Cu)	mg/L	0.011	0.44	0.008
Iron (Fe)	mg/L	0.12	5.5	0.059
Lead (Pb)	mg/L	0.00022	0.0011	<0.00005
Magnesium (Mg)	mg/L	11	18	2.1
Manganese (Mn)	mg/L	0.19	1.1	0.1
Mercury (Hg)	µg/L	0.018	< 0.02	0.016
Molybdenum (Mo)	mg/L	0.028	0.034	0.013
Nickel (Ni)	mg/L	0.0063	2.2	0.0031
Selenium (Se)	mg/L	0.00089	0.0034	0.00052
Silver (Ag)	mg/L	0.0013	<0.00005	<0.00005
Sodium (Na)	mg/L	45	13	4.2
Tellurium (Te)	mg/L	<0.0002	<0.0002	<0.0002
Thallium (Tl)	mg/L	0.0001	0.000025	0.000025
Vanadium (V)	mg/L	0.0042	0.0022	0.00059
Zinc (Zn)	mg/L	0.0038	0.86	0.0056

**Table 3-2 Comparison of Results from Unsaturated Overburden Leaching Tests**

Constituent	Drilling Samples (2008)	Sump Spoils (2010)
<b>Total Concentration, 95th Percentile</b>		
n	11	13
Sulfur (%)	0.03	0.03
Copper (ppm)	104	52
Nickel (ppm)	71	46
<b>Contact Water Leachate, 95th Percentile</b>		
n	3	13
Sulfate (mg/L)	15	8.4
Copper (mg/L)	0.008	0.007
Nickel (mg/L)	0.003	0.002

### 3.1.2 2011 Update

To accommodate the change in overall water quality modeling concept from deterministic to probabilistic, the results of leach testing (Table 3-1) were used to develop probability distributions of leachate chemistry for constituents from Unsaturated Overburden and Peat. Uniform distributions were defined from the maximum and minimum concentrations reported in Reference (1). Ranges for the leachate chemistry and the modeling methodology are discussed in Section 7.0.

No probability distributions were developed for the leachate chemistry for Saturated Overburden. As discussed in Section 7.0, Saturated Overburden will be treated as Category 2, 3 or 4 waste rock.

### 3.2 Overburden Management Concept

The concept for management of overburden is to classify overburden and to manage each classification as appropriate to its potential to release constituents.

- Unsaturated Overburden – Low potential to release constituents at levels that could have significant environmental impact; use as general construction material



Date: February 13, 2015	NorthMet Project Waste Characterization Data Package
Version: 12	Page 6

- Saturated Overburden – Potential to release constituents at levels that could have significant environmental impact; treat as Category 2, 3 or 4 waste rock (Section 7.3) or use in construction applications where it will be placed below the water table or above a membrane liner
- Peat – Potential to release mercury in drainage water; place in a primary storage location where surface runoff is managed and monitored, material to be used for reclamation and restoration



Date: February 13, 2015	NorthMet Project Waste Characterization Data Package
Version: 12	Page 7

## 4.0 Waste Rock

The purpose of waste characterization for waste rock is to determine the geochemical characteristics of the waste rock generated by the Project and use those characteristics to develop a general waste rock management concept.

### 4.1 Reports

#### 4.1.1 Initial Report

The initial report (Reference (3)) was submitted in 2007. A summary of the report is presented in the following paragraphs.

The results of initial chemical testing and long-term kinetic testing of 89 samples of NorthMet waste rock (82 samples plus 7 duplicates) and 3 samples of NorthMet ore were integrated with very long-term kinetic test work on rock with similar geology to develop an overall classification of the waste rock:

- Category 1 – sulfur content less than or equal to 0.12% - will not generate acid but may release metals
- Category 2 – sulfur content greater than 0.12% and less than or equal to 0.31% - may generate acid and consequently release metals at higher rates than Category 1
- Category 3 – sulfur content greater than 0.31% and less than or equal to 0.60% - will eventually generate acid and consequently release metals at higher rates than Category 2
- Category 4 – sulfur content greater than 0.60% - will rapidly generate acid and consequently release metals at higher rates than Category 3

Note that the above classification is a modification of the classification in Reference (3) in that the use of Cu/S ratio was eliminated and a sulfur content only classification developed.

The kinetic testing results were used to develop reasonable worst case (95th percentile) release rates for constituents from each category of waste rock. The reasonable worst case release rates are presented in Table 4-1.

**Table 4-1 2007 95th Percentile Results from Humidity Cell Tests (mg/kg/week)**

Constituent	2 <sup>(1)</sup>	3 (nonacidic)	4 (nonacidic)	4 (acidic Virginia)	Ore
Total Acidity	1.3	1.4	1.4	24	1.4
Alkalinity	7.9	9.5	15	0.88	5.2
Fluoride	0.027	0.024	0.030	0.034	0.041
Chloride	0.11	0.14	0.11	0.11	0.11
Sulfate	2.3	11	11	50	23
Aluminum (Al)	0.087	0.052	0.063	0.37	0.017
Antimony (Sb)	0.0044	0.0068	0.0044	0.00071	0.0014
Arsenic (As)	0.0088	0.0081	0.0075	0.0052	0.0059
Barium (Ba)	1.3	1.4	1.4	24	1.4
Boron (B)	0.0039	0.0054	0.016	0.021	0.011
Cadmium (Cd)	0.000020	0.000028	0.000021	0.0032	0.000022
Calcium (Ca)	2.2	4.7	3.4	3.5	7.3
Chromium (Cr)	0.00011	0.00011	0.00013	0.00012	0.00010
Cobalt (Co)	0.000053	0.0059	0.000086	0.039	0.0028
Copper (Cu)	0.00085	0.0084	0.00078	0.0048	0.0053
Iron (Fe)	0.015	0.011	0.030	9.5	0.0074
Lead (Pb)	0.000063	0.000069	0.000059	0.0011	0.000076
Magnesium (Mg)	0.44	0.82	0.31	3.9	1.5
Manganese (Mn)	0.00096	0.023	0.0033	0.12	0.022
Molybdenum (Mo)	0.000027	0.000043	0.00014	0.000026	0.000034
Nickel (Ni)	0.00024	0.070	0.00090	0.56	0.057
Selenium (Se)	0.00011	0.00020	0.00042	0.00060	0.00012
Silver (Ag)	0.000025	0.000031	0.000096	0.000029	0.000025
Thallium (Tl)	0.000010	0.000010	0.000010	0.000012	0.000010
Zinc (Zn)	0.0013	0.0040	0.00069	0.60	0.0021

(1) Humidity cell test results for Category 2 waste rock were used to represent the mixed Category 1/2 Waste Rock Stockpile.



Date: February 13, 2015	NorthMet Project Waste Characterization Data Package
Version: 12	Page 9

#### **4.1.2 2009 Update**

A general geochemical update report (Reference (4) Section 3) was submitted in 2009. A summary of the report is presented in the following paragraphs.

The results of ongoing kinetic testing were used to reassess and update the reasonable worst case release rates for constituents from each category of waste rock. In addition, Reasonable Alternative 1 was incorporated into the Mine Plan, removing Category 2 waste rock from the combined Category 1/2 Waste Rock Stockpile and instead including Category 2 waste rock in a combined Category 2/3 Waste Rock Stockpile. These changes are reflected in the updated reasonable worst case release rates presented in Table 4-2.

Following the publication of the 2009 geochemical update report, the waste rock characterization program was modified in consultation with MDNR to stop some tests and modify the frequency of analysis of leachates based on interpretation of the geochemical trends. The tests that were continued are indicated in Large Table 1 as having a total duration greater than 198 weeks (43 samples total were continued).



Date: February 13, 2015	NorthMet Project Waste Characterization Data Package
Version: 12	Page 10

**Table 4-2 Waste Rock and Ore: 2009 95th Percentile Results from Humidity Cell Tests (mg/kg/week)**

Constituent	Category 1 <sup>(1)</sup>	Category 3 <sup>(2)</sup> (nonacidic)	Category 4: nonacidic	Category 4: acidic (Virginia)	Ore
Total Acidity	1.4	1.8	1.9	26	2.1
Alkalinity	3.3	3.5	2.8	0.16	1.9
Fluoride	0.025	0.025	0.030	0.033	0.031
Chloride	0.10	0.10	0.14	0.10	0.11
Sulfate	1.3	8.3	17	50	20
Aluminum (Al)	0.063	0.043	0.022	0.51	0.0081
Antimony (Sb)	0.0025	0.0021	0.0021	0.0020	0.0025
Arsenic (As)	0.00035	0.0033	0.0054	0.00054	0.00077
Barium (Ba)	0.0056	0.0086	0.0064	0.0038	0.0063
Beryllium (Be)	0.00011	0.00011	0.00012	0.00056	0.000098
Boron (B)	0.0013	0.0046	0.012	0.015	0.011
Cadmium (Cd)	0.000020	0.000065	0.000043	0.0031	0.000070
Calcium (Ca)	1.8	3.6	5.2	2.2	5.5
Chromium (Cr)	0.00010	0.00010	0.00011	0.00012	0.000098
Cobalt (Co)	0.000053	0.017	0.019	0.039	0.037
Copper (Cu)	0.00088	0.096	0.0080	0.0071	0.059
Iron (Fe)	0.0067	0.012	0.10	9.7	0.0060
Lead (Pb)	0.000031	0.000052	0.00019	0.00060	0.000054
Manganese (Mn)	0.00080	0.027	0.049	0.087	0.086
Mercury (Hg)	0.0000045	0.0000045	0.0000045	0.0000099	0.0000098
Molybdenum (Mo)	0.000041	0.000032	0.000045	0.000024	0.000029
Nickel (Ni)	0.00034	0.21	0.14	0.47	0.62
Selenium (Se)	0.000098	0.00024	0.00033	0.00050	0.00023
Silver (Ag)	0.000024	0.000042	0.00015	0.000026	0.000025
Thallium (Tl)	0.0000098	0.000011	0.000011	0.000012	0.000014
Vanadium (V)	0.00021	0.0016	0.0012	0.000097	0.00011
Zinc (Zn)	0.0012	0.011	0.0073	0.49	0.015

(1) These values were incorrectly labeled as Category 2 in Reference (4).

(2) Includes humidity cell test results for Category 2 waste rock to represent the mixed Category 2/3 Waste Rock Stockpile.





Date: February 13, 2015	NorthMet Project Waste Characterization Data Package
Version: 12	Page 11

### **4.1.3 2011 Update**

#### **4.1.3.1 2011 Geochemical Update**

An updated analysis of the humidity cell data was submitted in 2011 (included as Attachment A). A summary of the report is presented in the following paragraphs. Note that a minor plotting error has been identified in Attachment A (the plot in Attachment 3 of Attachment A labeled total acidity is of total alkalinity) that does not affect the release rates used for modeling the NorthMet waste rock.

In order to accommodate the change in overall water quality modeling concept from deterministic to probabilistic, the results of ongoing kinetic testing were reevaluated and a new modeling approach was developed. The modeling approach is discussed in detail in Sections 8.1, 8.2, and 8.3.

Previous interpretation of the humidity cell test results assumed that the rates of constituent leaching indicated by the humidity cells were not constrained by solubility limitations due to the high liquid-to-solid ratios used in laboratory kinetic tests. Data from the humidity cells demonstrate that this is not the case for NorthMet waste rock: nickel leaching, for example, can increase by orders of magnitude even as oxidation and weathering of the sources of nickel decrease. A new approach was needed to account for the influence of solubility limits on the humidity cell leaching rates.

Chemical constituents, including, major mineral components and trace metals are released from host primary minerals as these minerals weather. The Project data indicated that after constituents are released from primary minerals, the concentrations of some of the chemical constituents in humidity cell tests were limited by solubility relationships with secondary minerals, while others were not. The release rates of constituents that appeared to be subject to solubility limitations were determined by identifying the likely mineral sources for each constituent using Project data and information from literature sources. The release rates of constituents that were potentially controlled by solubility relationships were identified by correlations with constituents in the same primary mineral host that were not controlled by solubility limitations.

This approach to estimating release rates relies on empirical analysis of the humidity cell data and data for metal content in the drill core samples (aqua regia digestion) and individual minerals (microprobe analysis). The rates and relationships determined for the different waste rock categories are therefore specific to this data set. The specific humidity cells used in this analysis, their rock type, sulfur content, and test duration are shown in Large Table 1. The proposed approach for developing release rates for each constituent is outlined in Large Table 2 and described further in Section 8.1.



Date: February 13, 2015	NorthMet Project Waste Characterization Data Package
Version: 12	Page 12

#### 4.1.3.2 Category 1 Concentration Caps Study

A laboratory study was initiated in 2010 in order to determine concentration caps for the Category 1 waste rock, as documented in Attachment B. A summary of the report is presented in the following paragraphs.

Concentration caps for the Category 1 waste rock were previously developed from the MDNR's AMAX field experiments, which were performed on Duluth Complex rock with much higher sulfur and metals content than is expected in Category 1 waste rock. The 2010 laboratory study was designed to provide direct measurements of concentration caps for use on Category 1 waste rock using a Sequential Meteoric Water Mobility Procedure (SMWMP).

The concentration caps study used oxidized coarse rejects from NorthMet drill cores to construct seven test columns for each of six samples representing the full range of sulfur in the Category 1 Waste Rock Stockpile. The sample material was all from 2005 drilling and was not freshly crushed (Attachment 1 of Attachment B). Water was slowly dripped through a column over the course of about one week and the exit water chemistry analyzed. This test is comparable to the State of Nevada's Meteoric Water Mobility Procedure. The collected leachate (less water removed for analysis) was passed through the subsequent column at the same leachate to sample ratio, and the procedure was repeated for all seven test columns for a given sulfur content (seven columns x six sulfur contents = 42 columns total). This method effectively simulates the performance of a tall column of oxidized waste rock (i.e., a waste rock stockpile) and provides ample contact time in order to achieve equilibrium chemistry.

Based on the results of this study, maximum concentration caps for the Category 1 waste rock have been developed for the majority of the constituents studied. Concentration caps are identified from the SMWMP test when concentrations stabilize in the later sequences of the test. For most constituents, this stabilizing trend occurs after several sequences of increasing concentrations as additional solute is mobilized from contact with newly-rinsed rock. For the purposes of this test, "stability" is defined as a lack of clear upward trends in all of the test samples. The concentration caps developed from this study are considered representative of the geochemical conditions at the pH range observed in the study, from pH 7.9 to pH 8.3.

For many constituents, the reported concentrations are close to the analytical detection limits, which varied throughout the study as leachate dilution was required in the final leaching step (resulting in higher detection limits). At concentrations less than five times the detection limit, analytical precision is lowest, with confidence limits ranging from  $\pm 20\%$  to  $100\%$  of the reported value. Because of the generally low concentrations for many trace metals, some erratic behavior is anticipated due to this low precision especially for the final leaching sequence. At concentrations between five and ten times the detection limit, confidence limits range from  $\pm 10\%$  to  $15\%$ , and above ten times the detection limit confidence limits are typically  $\pm 10\%$ . If stable concentrations are observed for multiple test sequences, erratic behavior at the final leaching sequence should not be interpreted as a change in the overall determination of concentration caps. In general, the concentration cap for each test sample is



Date: February 13, 2015	NorthMet Project Waste Characterization Data Package
Version: 12	Page 13

defined for modeling purposes as the highest concentration observed in the final two leaching sequences.

The SMWMP test also included a method blank, in which column construction materials were flushed using the same procedure as the test rock. For some constituents, the trace metal concentration in the blank was at or above the concentration in the rock leachate, reflecting possible contamination by the column materials. Because the water quality of the leachate was only analyzed at the final sequence, however, the effect of trends in trace metal concentrations is unknown.

Table 4-3 presents the maximum observed concentrations for all of the constituents in the analysis. Concentrations for some constituents were not constrained in the study, indicating that concentration caps were not reached. Alternative methods of determining concentration caps for select constituents are recommended in Attachment B. This information is used to develop probability distributions for the PolyMet method for modeling concentration caps, as discussed in Section 8.3. These results are not used in the water quality modeling at the direction of the Co-lead Agencies, as discussed in Section 8.3.1.

**Table 4-3 Maximum Concentrations from Category 1 SMWMP Test**

Constituent	units	Indicated Maximum Range <sup>(1)</sup>	Capped	Alternative Method
pH <sup>(2)</sup>	s.u.	7.9 – 8.3	yes	
Alkalinity	mg CaCO <sub>3</sub> /L	119 – 300	yes	
Fluoride	mg/L	0.23 – 0.53	yes	fluorite model <sup>(4)</sup>
Sulfate	mg/L	150 – 910	no	gypsum model <sup>(4)</sup>
Aluminum (Al)	mg/L	0.026 – 0.073	yes	
Antimony (Sb)	mg/L	0.007 – 0.012	yes	
Arsenic (As)	mg/L	0.008 – 0.053	yes	
Barium (Ba)	mg/L	0.004 – 0.034	no	barite model <sup>(4)</sup>
Beryllium (Be)	mg/L	0.00001	yes <sup>(3)</sup>	
Boron (B)	mg/L	0.10 – 0.46	no	field data <sup>(4)</sup>
Cadmium (Cd)	µg/L	0.008 – 0.051	yes	
Calcium (Ca)	mg/L	12.3 – 122	no	gypsum model <sup>(4)</sup>
Chromium (Cr)	mg/L	0.002 – 0.003	no	field data <sup>(4)</sup>
Cobalt (Co)	mg/L	0.05 – 0.31	yes	
Copper (Cu)	mg/L	0.0024 – 0.0065	no	field data <sup>(4)</sup>
Iron (Fe)	mg/L	0.006 – 0.017	yes	
Lead (Pb)	mg/L	0.00016 – 0.0012	yes <sup>(5)</sup>	
Manganese (Mn)	mg/L	0.005 – 0.017	yes	
Mercury (Hg)	µg/L	0.01 – 0.03	yes	
Molybdenum (Mo)	mg/L	0.014 – 0.021	yes	
Nickel (Ni)	mg/L	0.003 – 0.021	no	field data <sup>(4)</sup>
Selenium (Se)	mg/L	0.0025 – 0.0077	no	gypsum sequest. <sup>(4)</sup>
Silver (Ag)	µg/L	0.006 – 0.035	yes	
Thallium (Tl)	µg/L	0.014 – 0.050	yes	
Vanadium (V)	mg/L	0.0006 – 0.0030	yes	
Zinc (Zn)	mg/L	0.0022 – 0.0089	yes	

(1) Range shown is generally the highest observed from the final two leaching cycles for each of the 6 test samples

(2) pH value shown is the lowest observed after the first cycle

(3) Beryllium was not detected in the SMWMP leachate, the detection limit is shown as the concentration cap

(4) Section 8.3.1 for proposed alternative data sources to define concentration caps

(5) Lead concentrations peaked in cycles 3-4 then stabilized at lower levels in final cycles, peak values shown

Date: February 13, 2015	NorthMet Project Waste Characterization Data Package
Version: 12	Page 15

#### 4.1.4 2012 and 2014 Humidity Cell Trends Updates

Analyses of the ongoing humidity cell data were submitted in 2012 (Attachment C, including data through February 2012, and 2014 (Attachment D, including data through August 2013). A summary of these documents is presented in the following paragraphs.

- All Category 1 humidity cells have yielded pH above 6 throughout the program, typically fluctuating between 6.5 and 7.5 after an initial decline. For the 12 continuing tests, there is no indication that pHs will decline. Sulfate leaching rates have been low throughout the program with most continuing tests showing rates below 1 mg/kg/week.
- Six of the Category 2/3 humidity cells (including 3 of the 19 continuing tests, all of which contain Category 3 rock) generated acidic leachate (pH below 6), while all other samples have shown stable pHs (pH above 6) with similar trends to the Category 1 samples. The continuing nonacidic samples have now shown no acidic leachate after more than eight years of laboratory testing. Sulfate leaching rates have been between 1 and 10 mg/kg/week with the highest rates observed for samples with higher sulfur contents. A number of samples showed upward trends in nickel and cobalt leaching related to pH decrease below 7, with the trend being most pronounced for the samples generating acidic leachate (pH below 6). Nickel, cobalt and copper leaching have peaked and declined for most samples.
- All Category 4 humidity cells (Duluth Complex and Virginia Formation) have generated acidic leachate, demonstrating that most Category 4 rock can be expected to generate acid and that the timeframe to onset in humidity cell tests is several years in most cases. Some increases in sulfate leaching have been observed as pH decreases. Also, following a peak concentration sulfate leaching has been observed to decline. All samples show accelerated nickel leaching as pH decreases, as well as continuing upward trends in copper leaching.
- All three ore composite samples have shown pH and leaching trends similar to the Category 2/3 waste rock samples that have generated acidic leachate. The tests have shown a stable pH near 5 and nickel and copper leaching to a peak concentration, and then declining.

#### 4.2 Waste Rock Management Concept

The concept for management of waste rock is to classify waste rock and to manage each classification as appropriate to its potential to release constituents.

Waste rock that will not generate acid (Category 1) will be placed in a permanent stockpile with engineered systems to collect water that has contacted the rock and reduce the amount of water that contacts the rock at closure.



Date: February 13, 2015	NorthMet Project Waste Characterization Data Package
Version: 12	Page 16

Waste rock that will or may generate acid (Category 2,3,4) will be placed on temporary stockpiles with engineered systems to collect water that has contacted the rock and this rock will be relocated to the East Pit when mining is completed in that pit.

### **4.3 Waste Characterization Program as Applied to Waste Rock Stockpiles**

Large Table 3 shows the waste rock that will be placed in stockpiles or the East Pit organized by waste classification and geological unit compared to waste characterization samples for that same waste classification and geological unit.

There are 89 samples in the kinetic testing program. All samples selected for kinetic testing were also characterized using physical, mineralogical and chemical methods. Physical characterization involved determination of specific gravity and particle size distribution. Mineralogical characterization was optical and sub-optical. For the latter, microprobe was used to determine metal content of major sulfides, silicates and oxides. Static chemical analysis included sulfur and metal content determination on whole samples and particle size fractions and carbonate determination on whole samples. The base method for kinetic testing was the ASTM humidity cell (Procedure D 5744 – 96). Leachate analysis was performed to obtain the best possible detection limits using ICP-MS.

The Mine Plan will generate 217 million tons of Category 1 waste rock with an average sulfur content of 0.06%. The waste characterization program has 42 samples of this rock averaging 0.06% sulfur content. There are no samples for the Unit 7 rock, but as discussed Section 4.3.1, the waste characterization samples for Units 4, 5 and 6 represent the geochemical behavior of Unit 7.

The Mine Plan will generate 83 million tons of Category 2/3 waste rock with an average sulfur content of 0.21%. The waste characterization program has 26 samples of this rock averaging 0.29% sulfur content. There are no samples for the Unit 7 rock, but as discussed in Section 4.3.1, the waste characterization samples for Units 4, 5 and 6 represent the geochemical behavior of Unit 7.

The Mine Plan will generate 8.6 million tons of Category 4 waste rock with an average sulfur content of 1.90%. The waste characterization program has 21 samples of this rock averaging 1.90% sulfur content. There are no samples for Unit 3 rock, but the average sulfur content of 0.99% is less than the average sulfur content of the Virginia Formation (2.43%), which comprises most of the rock in the stockpile.

#### **4.3.1 Waste Characterization by Geologic Unit and Rock Type**

##### **4.3.1.1 Combination of Units 2 & 3 and 4 & 5**

Units 2 & 3 and Units 4 & 5 were combined in the Block Model into Units 3 and 5, respectively. Units 4 and 5 are now seen as one unit with a gradational change in texture from heterogeneous at the base (Unit 4) to more homogenous near the top (Unit 5). The

Date: February 13, 2015	NorthMet Project Waste Characterization Data Package
Version: 12	Page 17

division between the two has always been arbitrary and the combined thickness of the two is much more consistent across the deposit than the thicknesses of the individual units as defined in drill core logging. The data as to whether Units 2 and 3 are a single package are much more ambiguous, but as with Units 4 & 5, the combined thicknesses are more consistent across the deposit than the thicknesses of the individual units and the contact between 2 & 3 can be somewhat arbitrary. In general, the basal contacts of Units 7, 6, 4, 2 and 1 are sharp, that is that as one goes along the core there is a visible change over a very short distance in texture, mineral proportion, or sulfide content. The basal contacts of Units 5 and 3 are gradational in that these changes occur over a distance of feet to tens of feet

#### 4.3.1.2 Unit 7

About 23 million tons (about 7.4% of total waste rock) of Unit 7 rock will be placed in stockpiles or the East Pit. Because the preliminary 20 year mine pit shell that was available when the Waste Characterization Plan was developed did not show that Unit 7 will be mined, no samples from Unit 7 were included in the waste characterization plan. The waste characterization samples for Units 4, 5 and 6 represent the geochemical behavior of Unit 7 because:

- The basic geology of the Units 4, 5, 6 and 7 (the upper anorthositic rocks of the deposit) is essentially the same. Whole rock analysis (Figure 4-1) shows Units 4, 5 and 7 to chemically be nearly identical and Units 6 and 7 to be similar, with differences in iron and magnesium content between the two reflecting slightly different proportions of olivine and pyroxene in those units. Generalized mineralogy is the same for all units at NorthMet, plagioclase, olivine and pyroxene in varying proportions make up the bulk of the rock (Reference (5) pages 16-19). This is also reflected in silicate, sulfide and oxide mineral chemistry (Reference (5) appendices).
- Sulfur distribution in Units 4, 5, 6 and 7 is very similar. Figure 4-2 shows the sulfur distribution in the Unit 5 (4 & 5), 6 and 7 core (light line with markers) used to select samples for the kinetic test program and in the larger amount of core available now (heavy line). This shows that the additional drill core data have not changed the distribution. The large circular markers show the percent sulfur in the Unit 5 and Unit 6 waste characterization tests, which cover the range of Unit 7 sulfur content. Figure 4-3 through Figure 4-7 show the minimum, average and maximum for sulfur, copper, nickel, cobalt and zinc in the current core data by unit. The Unit 7 values are within the range of the other units. These figures show that there is not more sulfur or metals present in Unit 7 compared to the other units.
- Stratigraphic unit is not a significant driver to the acid producing or metal leaching rates (Reference (6)).

Unit 7 in the area to be mined contains an estimated 10 to 20 percent ultramafic rock while other units have less. Because the data set used to generate Figure 4-1 through Figure 4-7

includes ultramafic and troctolitic/anorthositic rocks, the fact that there is more ultramafic in Unit 7 than the other units is included in the above analysis. Table 4-4 shows that each Category of waste rock in the waste characterization program has ultramafic samples. As stated above, in general, metals do not vary by rock type in the waste rock. There are a few broad exceptions driven by mineralogy, such as higher aluminum in more anorthositic rocks (higher plagioclase content) and higher iron and magnesium in more ultramafic (higher olivine content) rocks.

**Table 4-4 Waste Characterization Tests by Rock Type**

Stockpile	Rock Type	Samples	Sulfur		
			Min	Avg	Max
Cat 1	Anorthositic	10	0.02	0.04	0.09
Cat 1	Troctolitic	24	0.02	0.05	0.08
Cat 1	Ultramafic	8	0.06	0.08	0.12
Cat 2/3	Anorthositic	2	0.18	0.18	0.18
Cat 2/3	Sedimentary Hornfels	3	0.24	0.41	0.55
Cat 2/3	Troctolitic	17	0.14	0.29	0.59
Cat 2/3	Ultramafic	4	0.16	0.25	0.34
Cat 4	Anorthositic	3	0.68	1.12	1.83
Cat 4	Sedimentary Hornfels	4	1.46	2.53	4.46
Cat 4	Troctolitic	6	0.77	1.22	1.68
Cat 4	Ultramafic	4	0.72	0.98	1.24
Cat 4	Virginia	4	2.00	3.82	5.68



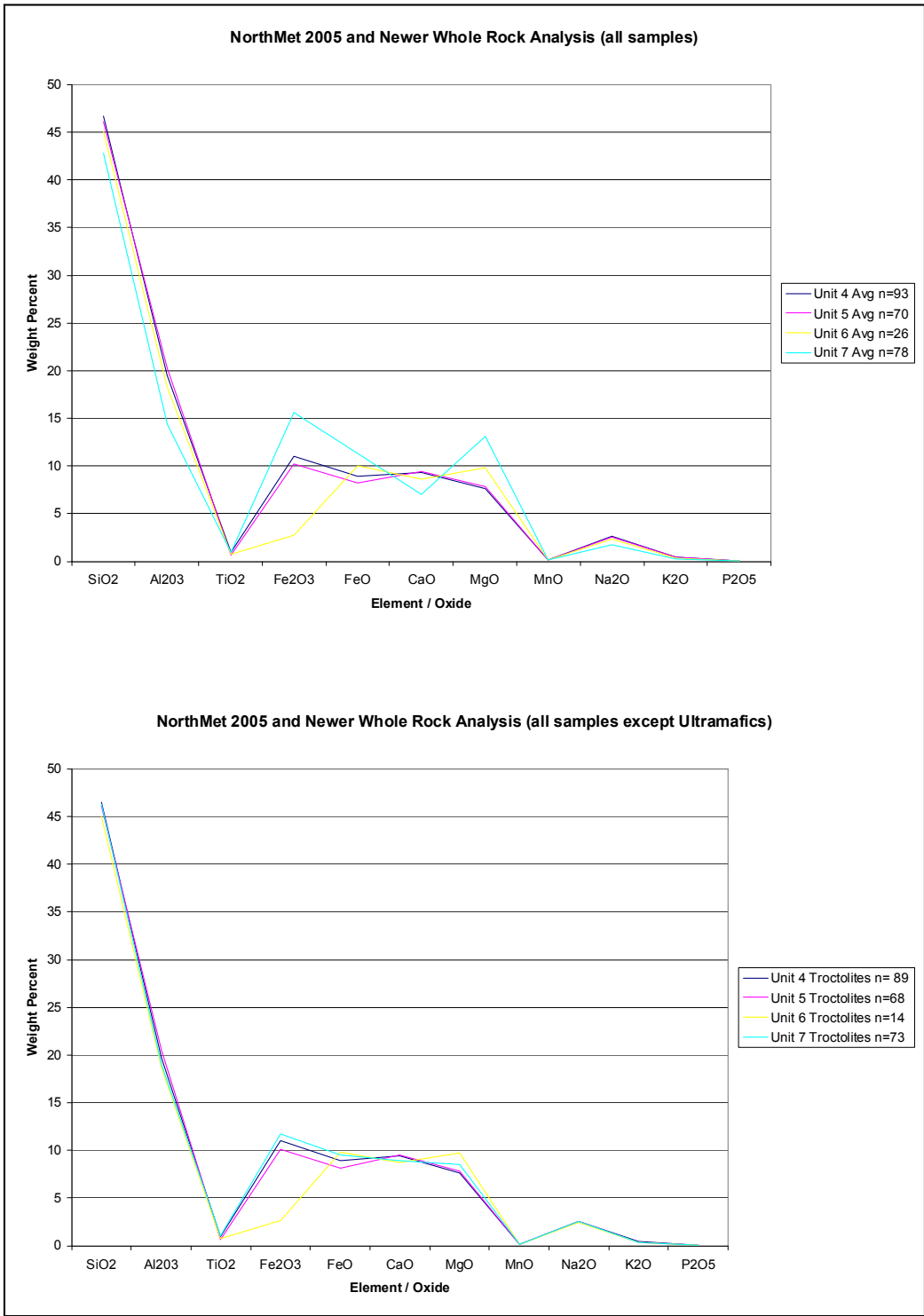

**Figure 4-1 Whole Rock Analysis**

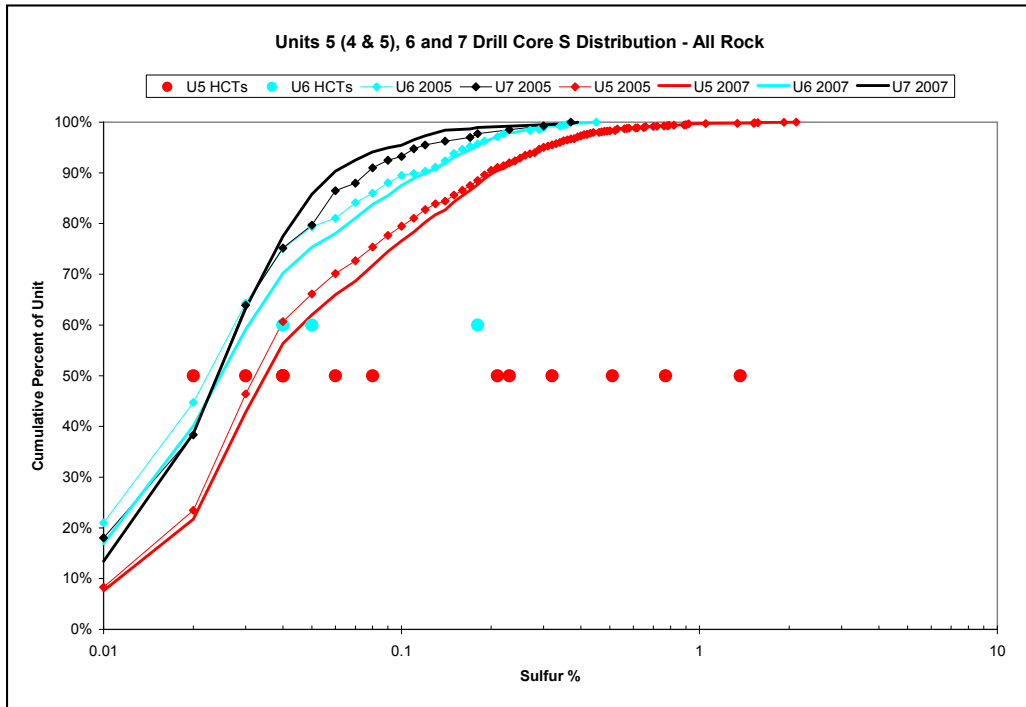

Figure 4-2 Drill Core Sulfur Distribution with Samples

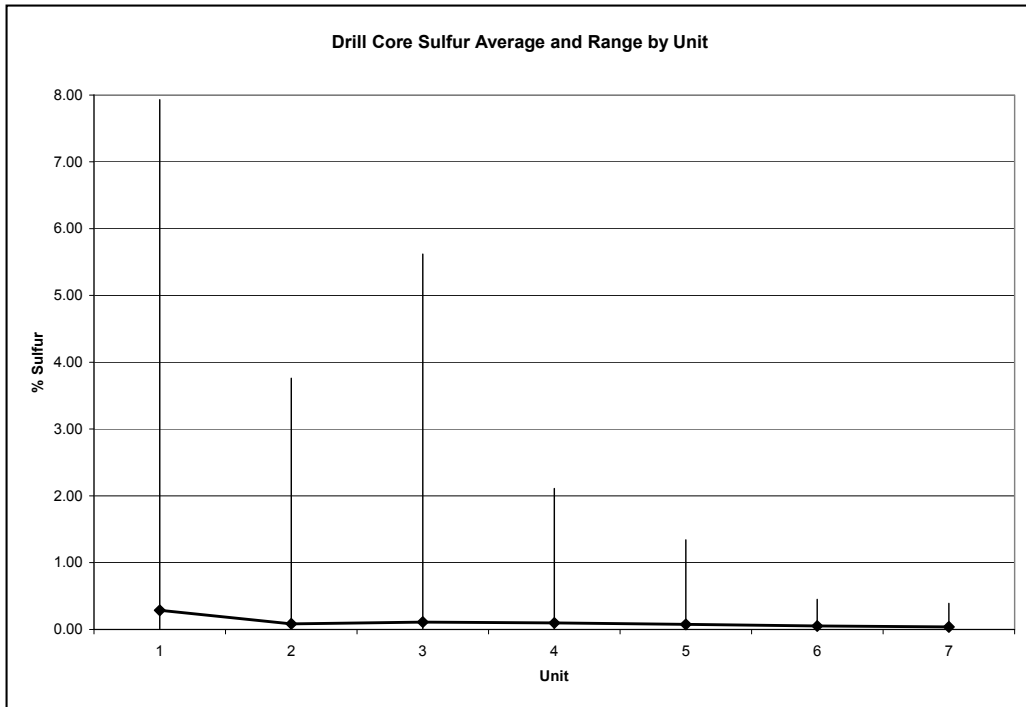

Figure 4-3 Drill Core Sulfur

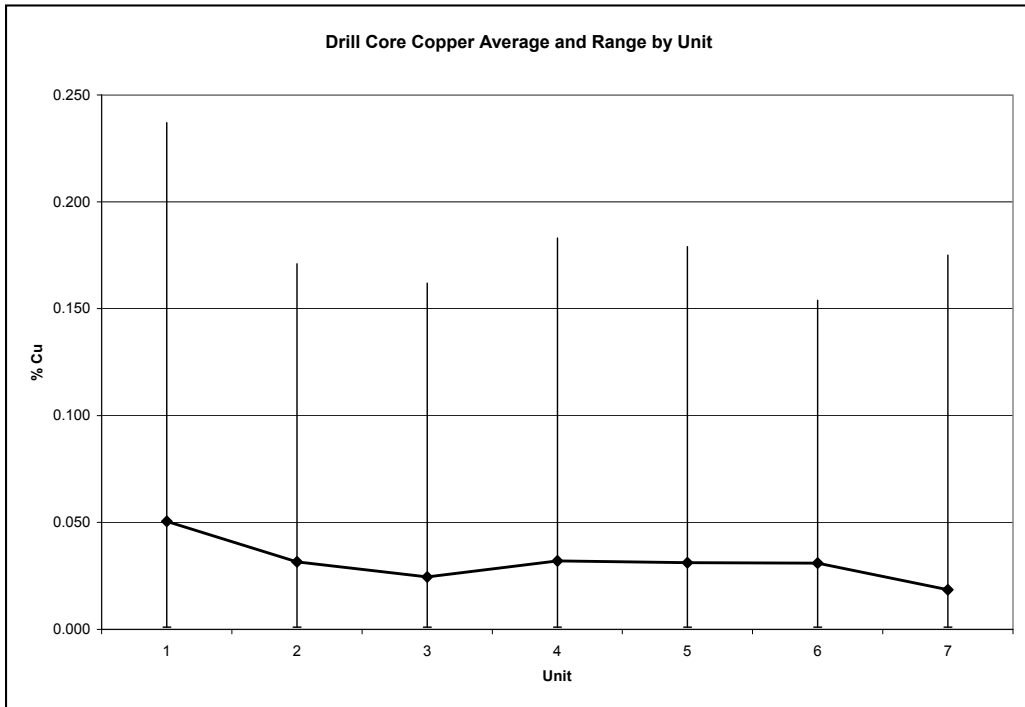

Figure 4-4 Drill Core Copper

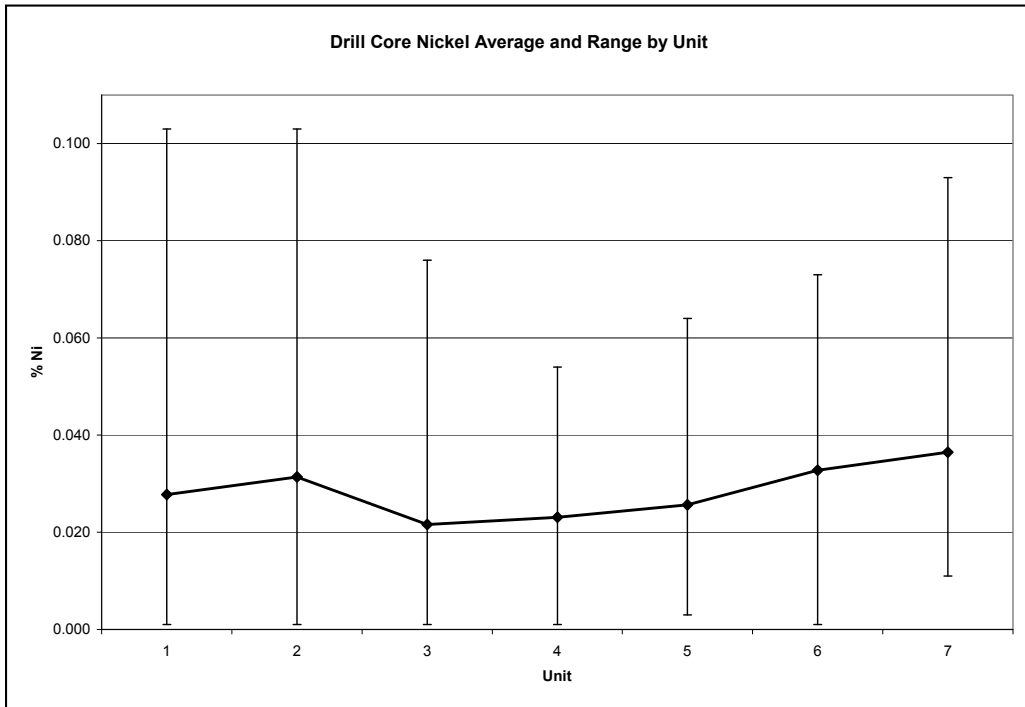

Figure 4-5 Drill Core Nickel

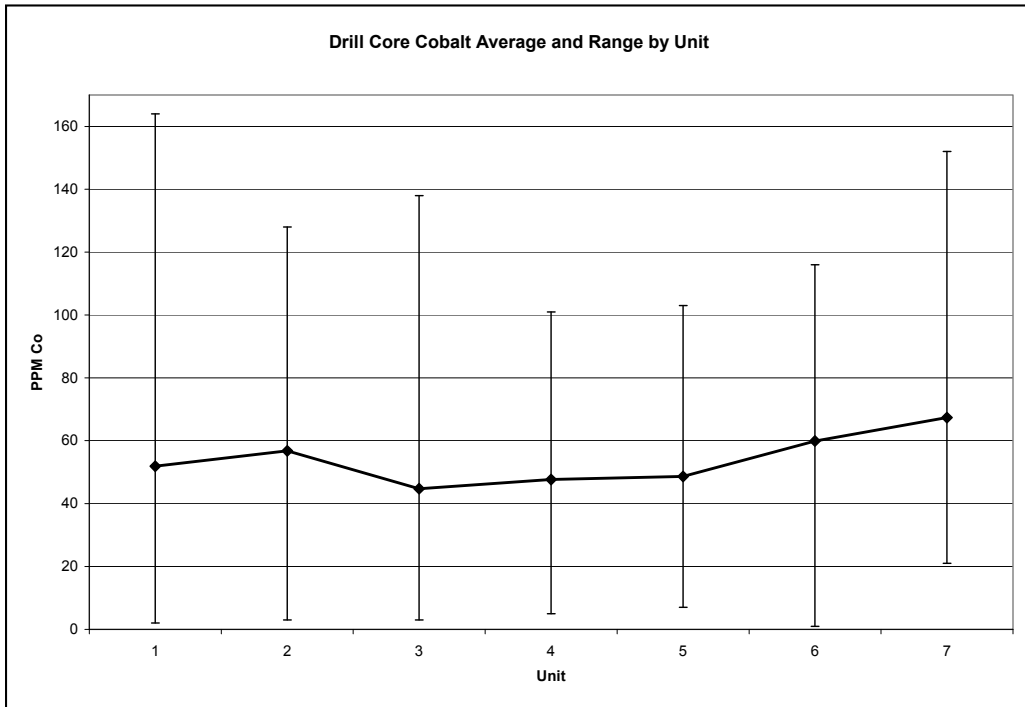

Figure 4-6 Drill Core Cobalt

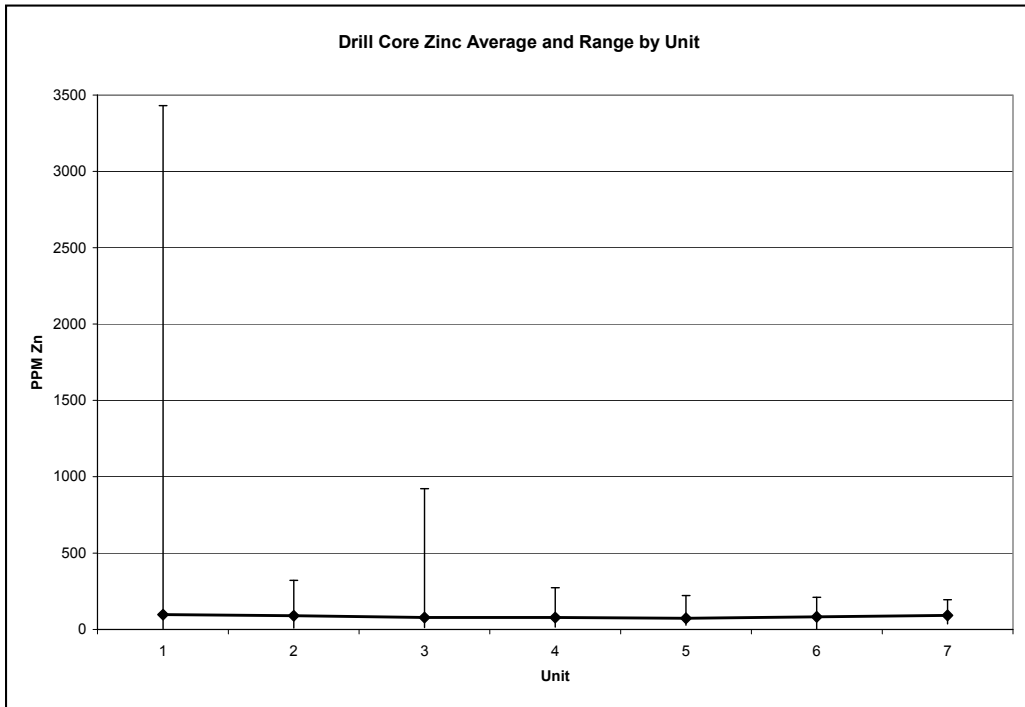

Figure 4-7 Drill Core Zinc



Date: February 13, 2015	NorthMet Project Waste Characterization Data Package
Version: 12	Page 23

### 4.3.2 Sulfur Content of Stockpiles and Pit Walls

The Block Model contains the modeled sulfur content of each block of waste rock and ore. This information is used as described in Section 8.1.1.1 to model sulfate release for the Category 1 and Category 2/3 waste rock and ore (stockpiles and pit walls) and is not used for modeling the other waste rock categories. Sulfur distribution data for all waste and wall rock categories are presented here for completeness.

The average sulfur content of the Category 1 waste rock as a whole is 0.064%. The sulfur content of the portion of the Category 1 waste rock to be stored in the Category 1 Waste Rock Stockpile (approximately three quarters of all Category 1 material generated) is 0.063%. The sulfur content of the Category 1 waste rock placed directly in the East Pit is 0.068%. The distribution of sulfur content by mass for the Category 1 waste rock is shown in Figure 4-8.

The average sulfur content of the Category 2/3 waste rock as a whole is 0.21%. The sulfur content of the portion of the Category 2/3 waste rock to be temporarily stored in the Category 2/3 Waste Rock Stockpile (approximately half of all Category 2/3 material generated) is 0.20%. The sulfur content of the Category 2/3 waste rock placed directly in the East Pit is 0.21%. The distribution of sulfur content by mass for the Category 2/3 waste rock is shown in Figure 4-9.

The average sulfur content of the NorthMet ore is 0.608%. The total mass of ore produced under the Mine Plan is 225,280,000 short tons. The ore will be stored temporarily as necessary during mining in the Ore Surge Pile (OSP) before being transported to the Plant Site. The material in the OSP at any time will be a blend of ore from different active mining locations and is assumed to have nearly-constant average sulfur content equal to the average sulfur content in the Block Model.

The average sulfur content of the Duluth Complex Category 4 waste rock as a whole is 0.95%. Nearly 80% of this material will be placed directly in the East Pit and will not be stored in the Category 4 Waste Rock Stockpile. The Virginia Formation Category 4 waste rock, in contrast, will all be temporarily stored in the Category 4 Waste Rock Stockpile. The average sulfur content of the Virginia Formation Category 4 waste rock is 2.43%. The distribution of sulfur content by mass for the Category 4 waste rock (Duluth Complex and Virginia Formation separately) is shown in Figure 4-10. Note that this information is not used in the water quality modeling described in Section 8.1.1.1 but is included here for completeness.

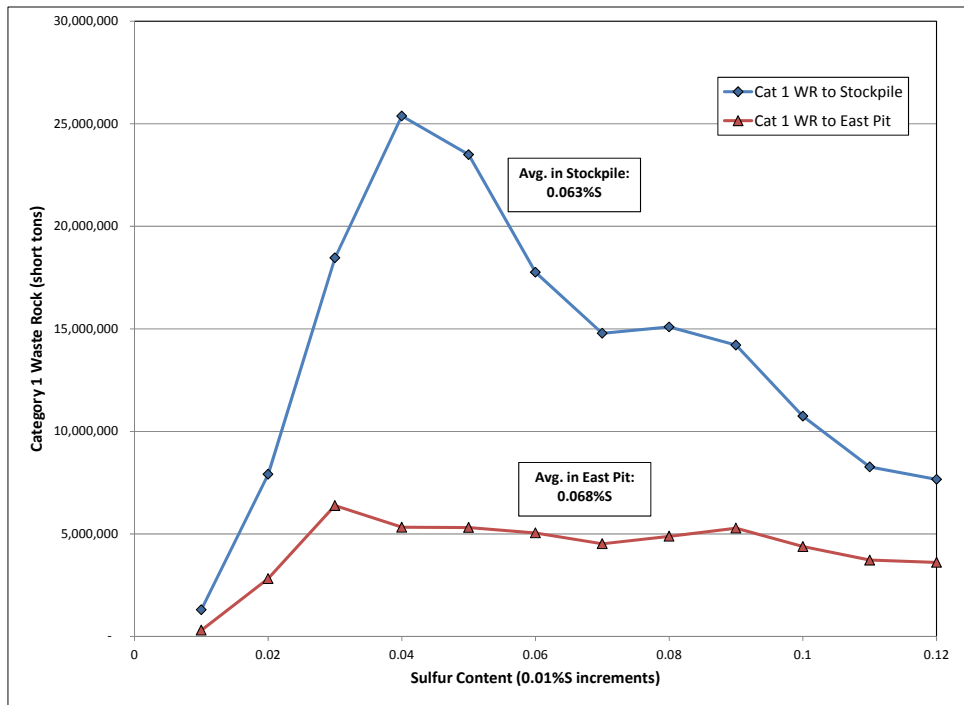

**Figure 4-8 Sulfur Content Distribution for Category 1 Waste Rock**

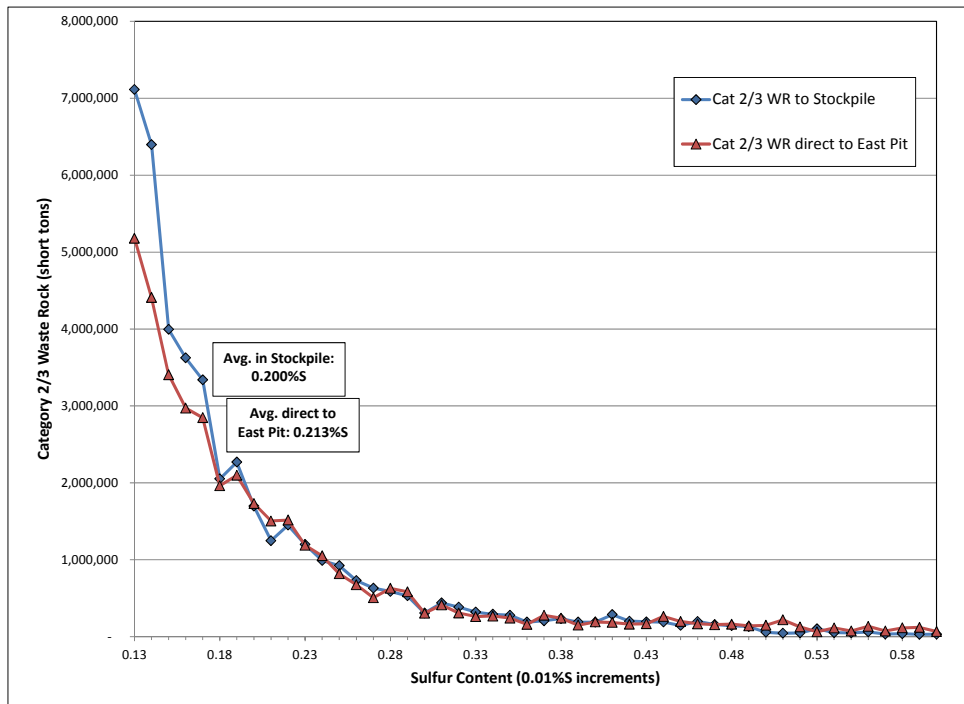

**Figure 4-9 Sulfur Content Distribution for Category 2/3 Waste Rock**

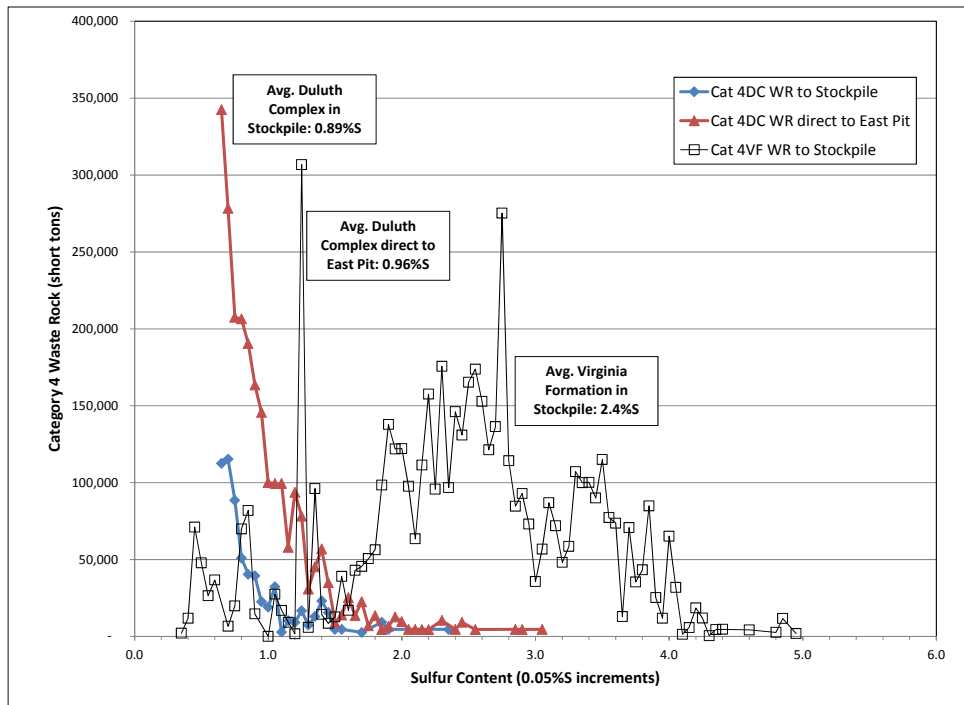

**Figure 4-10 Sulfur Content Distribution for Category 4 Waste Rock**

Data from the Block Model are also used to model the quantity and sulfur content of each category of wall rock. The relative proportion of each category of wall rock at 20-foot intervals was determined based on the Block Model, as shown in Figure 4-11 for the East Pit and in Figure 4-12 for the West Pit. The plan area (looking down) of each pit was determined from the pit geometry, with the pit walls blasted below the bedrock rim and the 20-foot pit rim set back at the top of bedrock considered separately (Section 9.2). The total plan area above a given elevation of pit wall is shown for both pits in Figure 4-13. These two data sets are used together to determine the exposed area of each category of wall rock at any elevation. The pit rim set back is assumed to have the same relative composition of the various rock categories as the main pit wall.

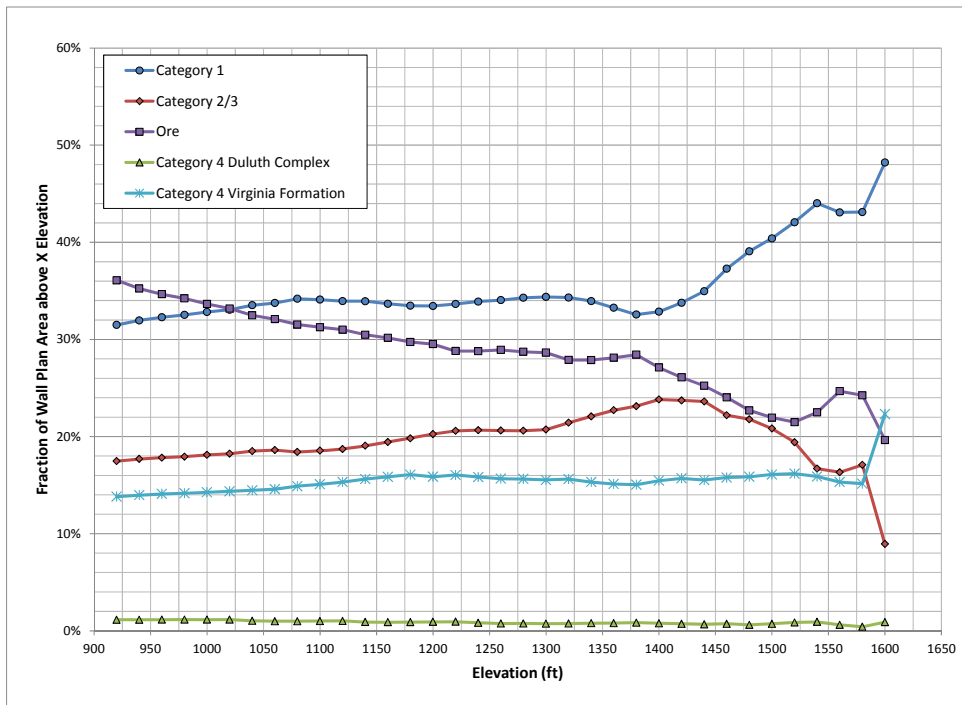

Figure 4-11 Wall Rock Category Fractions for the East Pit

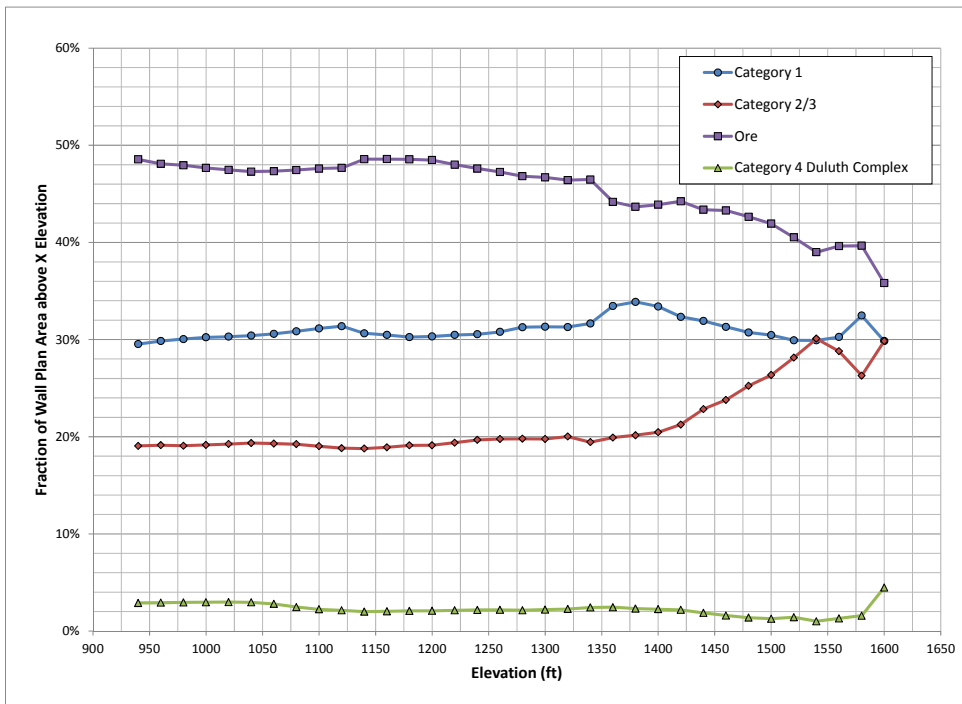
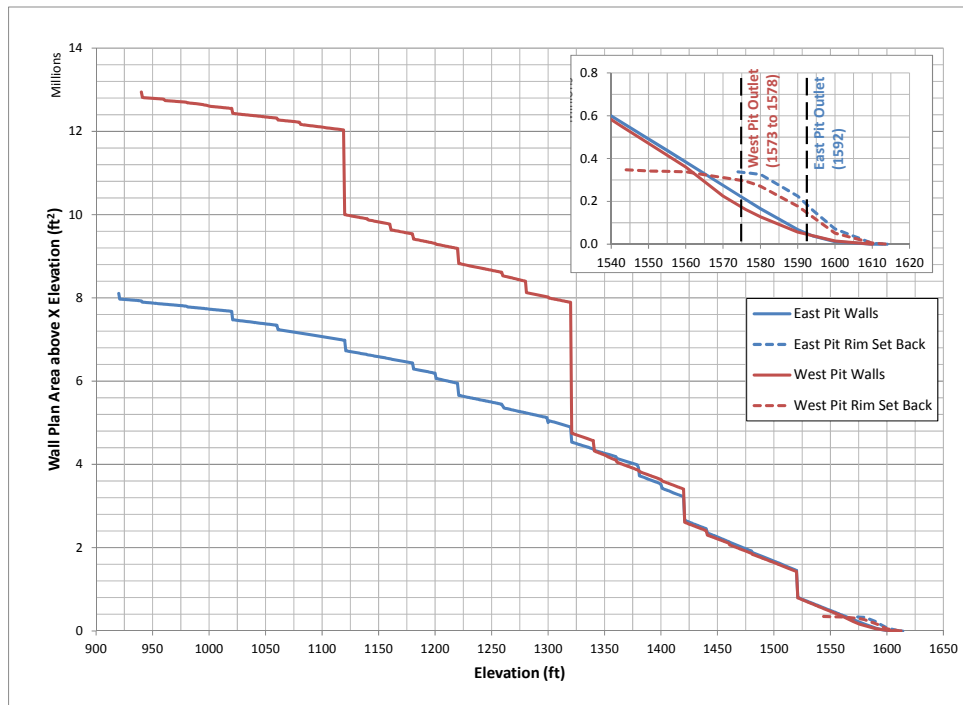

Figure 4-12 Wall Rock Category Fractions for the West Pit





**Figure 4-13 Total Pit Wall Rock Areas**

Similar data from the Block Model were used to determine the area-weighted average sulfur content for all wall rock above a given elevation (by rock category). Because the pit walls are modeled as having a constant thickness of reactive wall rock (Section 9.2), the area-weighted average sulfur content is analogous to a mass-weighted average. This information is used as described in Section 8.1.1.1 to model sulfate release for the Category 1 and Category 2/3 waste rock and ore and is not used for modeling the other waste rock categories. Sulfur distribution data for all waste and wall rock categories are presented here for completeness.

Figure 4-14 shows the average sulfur content for the East Pit and West Pit for the Category 1 wall rock. Figure 4-15 shows the average sulfur content for the East Pit and West Pit for the Category 2/3 wall rock. Figure 4-16 shows the average sulfur content for the East Pit and West Pit for the Duluth Complex Category 4 wall rock. Figure 4-17 shows the average sulfur content for the East Pit for the Virginia Formation Category 4 wall rock (there is no Virginia Formation wall rock in the West Pit). Figure 4-18 shows the average sulfur content for the East Pit and West Pit for all wall rock classified as ore.

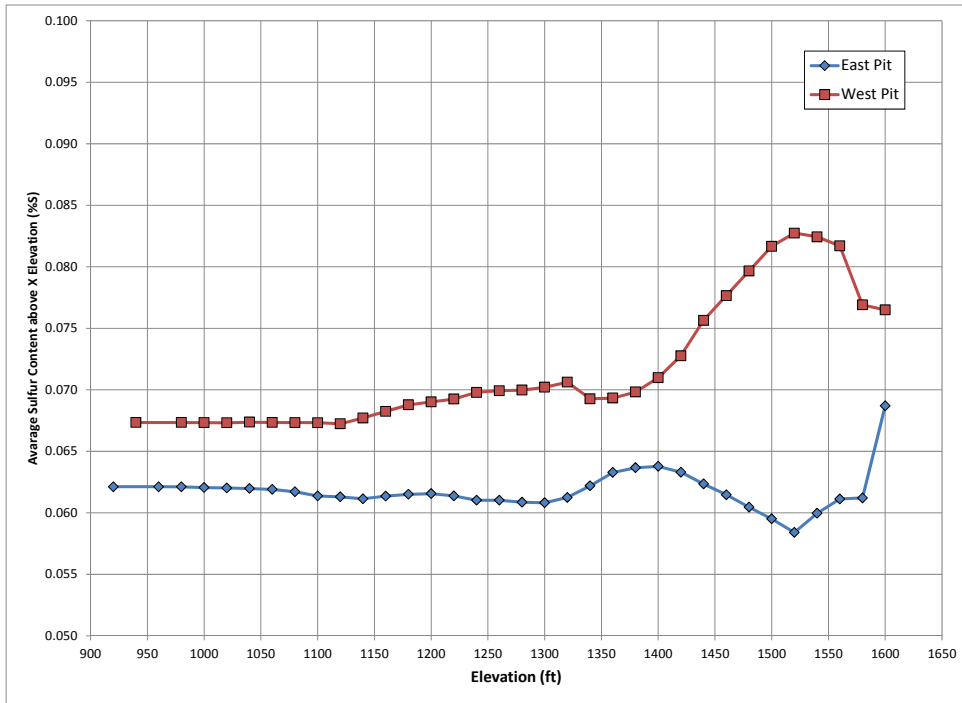

Figure 4-14 Sulfur Content with Depth for Category 1 Wall Rock

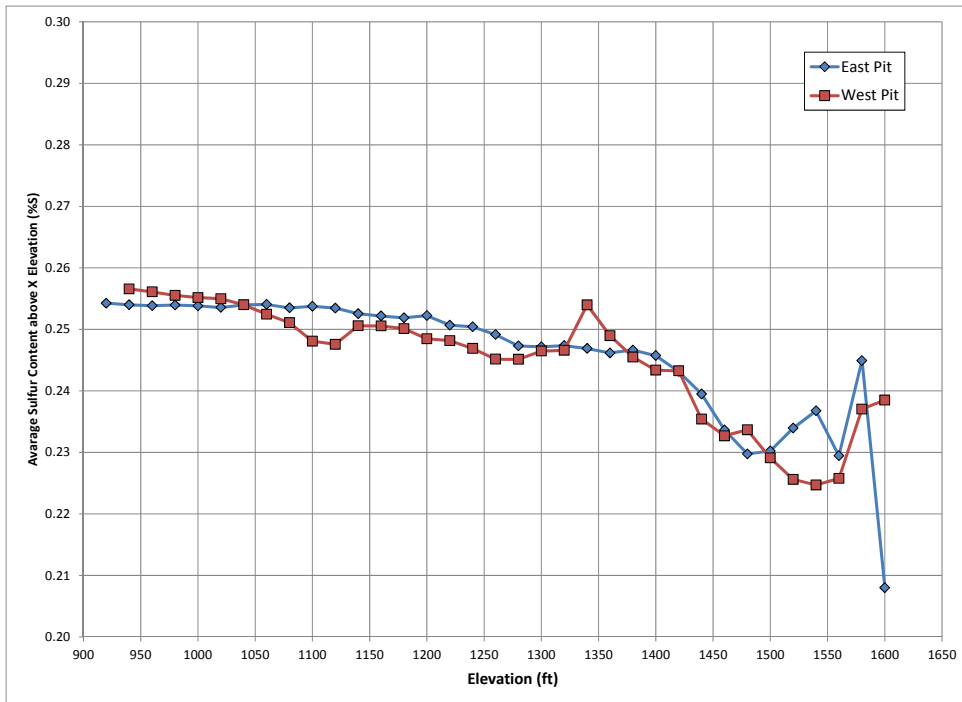

Figure 4-15 Sulfur Content with Depth for Category 2/3 Wall Rock

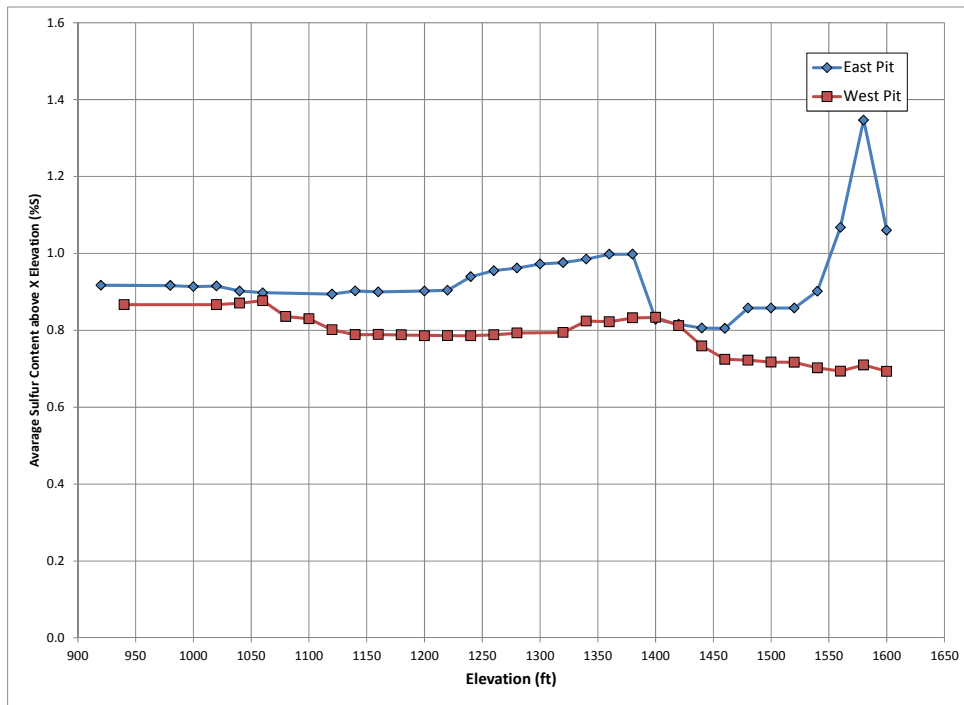

Figure 4-16 Sulfur Content with Depth for Duluth Complex Category 4 Wall Rock

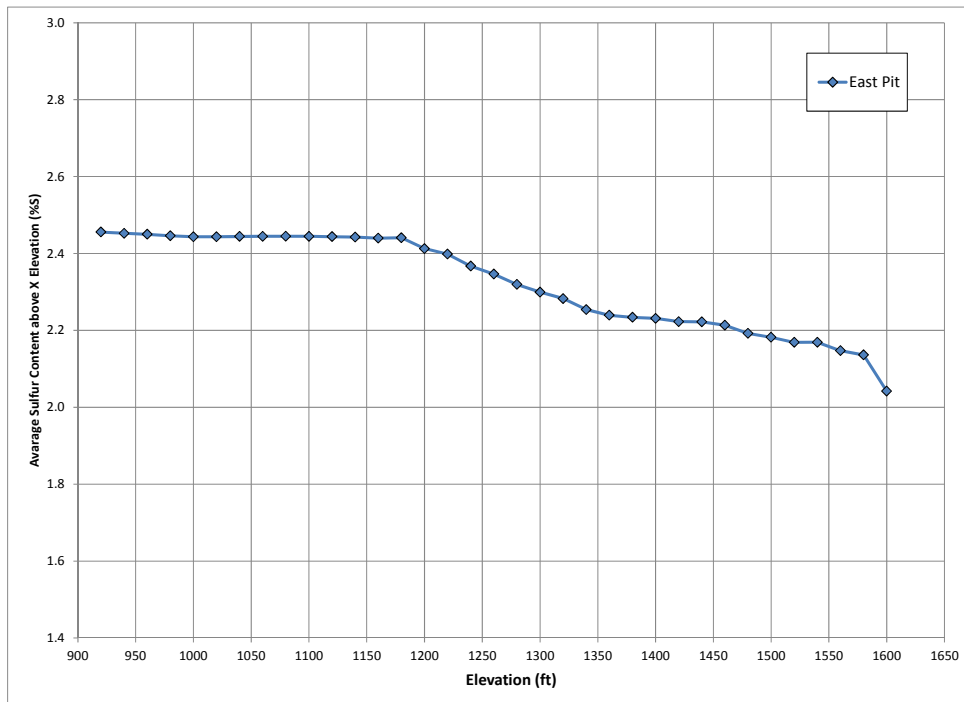
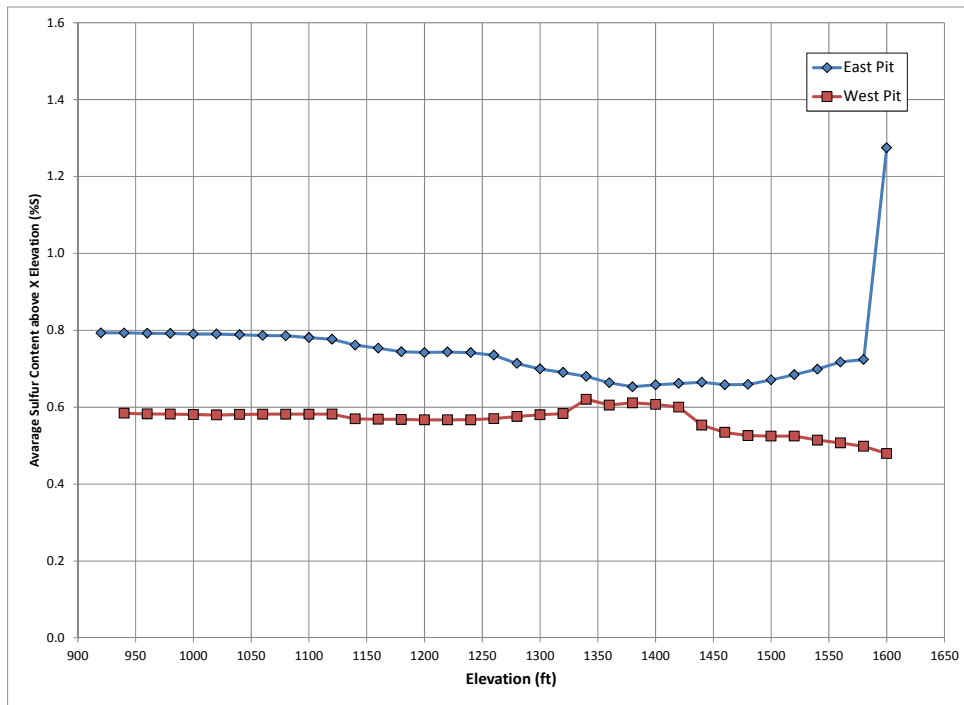

Figure 4-17 Sulfur Content with Depth for Virginia Formation Category 4 Wall Rock



**Figure 4-18 Sulfur Content with Depth for Ore Wall Rock**

## 5.0 Flotation Tailings

The purpose of waste characterization for Flotation Tailings is to determine the geochemical characteristics of the Flotation Tailings generated by the Project and use those characteristics to develop a general Flotation Tailings management concept.

### 5.1 Reports

#### 5.1.1 Initial Report

The initial report (Reference (7)) was submitted in 2007. A summary of the report is presented in the following paragraphs.

The results of initial chemical testing and long-term kinetic testing of 13 samples of Flotation Tailings were integrated with kinetic test work on tailings from processing ore with similar geology to develop an overall understanding of the tailings:

- bulk tailings will not generate acid
- bulk tailings will release metals

Tailings size fractions have different geochemical characteristics (Testing of different size fractions was initiated because PolyMet originally proposed to construct dams from the coarse and mid-size tailings. This is no longer being proposed.)

The kinetic testing results were used to develop average case reaction rate constants for the oxidation of sulfides in coarse and fine Flotation Tailings. The average reaction rate constants are presented in Table 5-1. Average case release of other constituents was determined based on the kinetic testing results in terms of the ratio between molar release of sulfate (from sulfide oxidation) and molar release of other constituents. The average release ratios are presented in Table 5-2.

**Table 5-1 2007 Average Reaction Rate Constants from Humidity Cell Tests**

Tailings Type	Reaction Rate Constant (1/s)
Coarse	$3.38 \times 10^{-8}$
Fine	$6.50 \times 10^{-8}$

**Table 5-2 2007 Average Release Ratios from Humidity Cell Tests (mol/mol SO<sub>4</sub>)**

Constituent	Coarse Tailings	Fine Tailings
Antimony (Sb)	4.0 x 10 <sup>-5</sup>	4.0 x 10 <sup>-5</sup>
Arsenic (As)	2.0 x 10 <sup>-4</sup>	4.2 x 10 <sup>-4</sup>
Beryllium (Be)	1.4 x 10 <sup>-4</sup>	1.3 x 10 <sup>-4</sup>
Boron (B)	6.0 x 10 <sup>-4</sup>	8.5 x 10 <sup>-4</sup>
Cadmium (Cd)	2.3 x 10 <sup>-6</sup>	2.1 x 10 <sup>-6</sup>
Calcium (Ca)	1.8 x 10 <sup>-1</sup>	4.1 x 10 <sup>-2</sup>
Cobalt (Co)	3.9 x 10 <sup>-5</sup>	1.3 x 10 <sup>-5</sup>
Copper (Cu)	1.5 x 10 <sup>-4</sup>	1.4 x 10 <sup>-4</sup>
Lead (Pb)	1.6 x 10 <sup>-6</sup>	1.4 x 10 <sup>-6</sup>
Magnesium (Mg)	3.8 x 10 <sup>-1</sup>	4.5 x 10 <sup>-1</sup>
Nickel (Ni)	6.6 x 10 <sup>-4</sup>	6.5 x 10 <sup>-5</sup>
Potassium (K)	3.3 x 10 <sup>-1</sup>	2.8 x 10 <sup>-1</sup>
Selenium (Se)	1.6 x 10 <sup>-5</sup>	1.5 x 10 <sup>-5</sup>
Silver (Ag)	3.0 x 10 <sup>-6</sup>	2.7 x 10 <sup>-6</sup>
Sodium (Na)	1.1 x 10 <sup>-1</sup>	2.3 x 10 <sup>-1</sup>
Thallium (Tl)	6.3 x 10 <sup>-7</sup>	5.8 x 10 <sup>-7</sup>
Zinc (Zn)	1.2 x 10 <sup>-3</sup>	6.4 x 10 <sup>-4</sup>

### 5.1.2 2009 Update

A general geochemical update report (Reference (4) Section 4) was submitted in 2009. A summary of the report is presented in the following paragraphs.

The results of ongoing kinetic testing were used to reassess and update the average release ratios for constituents from the coarse and fine tailings. The updated data indicated no change in reaction rate constants for either the coarse or fine tailings. The Mine Plan was updated to provide for deposition of Flotation Tailings as bulk tailings across the entire basin, rather than as segregated depositional areas. The reaction rate constant for bulk tailings was summarized in a modeling assumptions memorandum (Reference (8)) along with the average release ratios for the bulk tailings. Updated reaction rate constants for coarse, fine and bulk tailings are presented in Table 5-3 and updated average release ratios are presented in Table 5-4.

**Table 5-3 2009 Average Reaction Rate Constants from Humidity Cell Tests**

Tailings Type	Reaction Rate Constant (1/s)
Coarse <sup>(1)</sup>	3.38 x 10 <sup>-8</sup>
Fine <sup>(1)</sup>	6.50 x 10 <sup>-8</sup>
Bulk	3.82 x 10 <sup>-8</sup>

(1) 2009 modeling assumed only bulk tailings. Values for coarse and fine tailings are shown for comparison only.

**Table 5-4 2009 Average Release Ratios from Humidity Cell Tests (mol/mol SO<sub>4</sub>)**

Constituent	Coarse Tailings <sup>(1)</sup>	Fine Tailings <sup>(1)</sup>	Bulk Tailings
Aluminum (Al)	1.8 x 10 <sup>-2</sup>	5.2 x 10 <sup>-2</sup>	3.5 x 10 <sup>-2</sup>
Antimony (Sb)	2.5 x 10 <sup>-5</sup>	7.2 x 10 <sup>-5</sup>	9.8 x 10 <sup>-6</sup>
Arsenic (As)	1.5 x 10 <sup>-4</sup>	6.1 x 10 <sup>-4</sup>	2.9 x 10 <sup>-4</sup>
Beryllium (Be)	1.3 x 10 <sup>-4</sup>	2.1 x 10 <sup>-4</sup>	1.6 x 10 <sup>-4</sup>
Boron (B)	1.8 x 10 <sup>-3</sup>	4.5 x 10 <sup>-3</sup>	2.0 x 10 <sup>-3</sup>
Cadmium (Cd)	2.5 x 10 <sup>-6</sup>	3.7 x 10 <sup>-6</sup>	2.6 x 10 <sup>-6</sup>
Calcium (Ca)	1.8 x 10 <sup>-1</sup>	4.1 x 10 <sup>-2</sup>	6.7 x 10 <sup>-1</sup>
Cobalt (Co)	1.3 x 10 <sup>-4</sup>	1.6 x 10 <sup>-5</sup>	1.3 x 10 <sup>-5</sup>
Copper (Cu)	2.1 x 10 <sup>-4</sup>	4.1 x 10 <sup>-4</sup>	1.4 x 10 <sup>-4</sup>
Lead (Pb)	1.4 x 10 <sup>-6</sup>	2.9 x 10 <sup>-6</sup>	2.0 x 10 <sup>-6</sup>
Magnesium (Mg)	3.8 x 10 <sup>-1</sup>	4.5 x 10 <sup>-1</sup>	5.6 x 10 <sup>-1</sup>
Nickel (Ni)	2.6 x 10 <sup>-3</sup>	1.2 x 10 <sup>-4</sup>	5.0 x 10 <sup>-5</sup>
Potassium (K)	3.3 x 10 <sup>-1</sup>	2.8 x 10 <sup>-1</sup>	4.5 x 10 <sup>-1</sup>
Selenium (Se)	1.8 x 10 <sup>-5</sup>	2.7 x 10 <sup>-5</sup>	1.8 x 10 <sup>-5</sup>
Silver (Ag)	2.7 x 10 <sup>-6</sup>	4.4 x 10 <sup>-6</sup>	3.4 x 10 <sup>-6</sup>
Sodium (Na)	1.0 x 10 <sup>-1</sup>	3.0 x 10 <sup>-1</sup>	2.2 x 10 <sup>-1</sup>
Thallium (Tl)	6.3 x 10 <sup>-7</sup>	9.3 x 10 <sup>-7</sup>	7.1 x 10 <sup>-7</sup>
Zinc (Zn)	4.6 x 10 <sup>-4</sup>	2.4 x 10 <sup>-4</sup>	2.1 x 10 <sup>-4</sup>

(1) 2009 modeling assumed only bulk tailings. Values for coarse and fine tailings are shown for comparison only.

Date: February 13, 2015	NorthMet Project Waste Characterization Data Package
Version: 12	Page 34

### 5.1.3 2011 Update

#### 5.1.3.1 Depositional Study

For modeling purposes, it is important to know whether the delta that is formed as tailings are deposited in the FTB can be treated as one “bulk” zone of tailings or needs to be further refined into multiple zones of different grain size fractions. The University of Minnesota’s St. Anthony Falls Laboratory (SAFL) performed experiments to quantify the potential for segregation in the tailings delta and to determine some of the important hydraulic properties of the deposited tailings. SAFL performed two phases of experiments. Phase I was a flume experiment, designed to use field-scale flow conditions to evaluate the potential for debris flow versus channelized or sheet flow as the delta is formed. Phase II was a 2D lab scale experiment designed to answer the questions about segregation and hydraulic properties. A report was prepared by SAFL and submitted in March, 2011 (included as Attachment E).

The Phase I experiment clearly showed that the behavior of the delta is one of a fluvial system characterized by channelized or sheet flow. In other words, debris or “mud” flow will not occur. The solids were transported throughout the delta as bedload and suspended load. The tendency of the tailings slurry discharge was to channelize and form braids, with bars and bedforms that developed in the active channels. Therefore, the deposition patterns are characteristic of those observed in other tailings basins and deltaic systems in general, where the combined fluvial processes of erosion, transport and deposition at the channel and larger scales (not at the individual grain size scale) determine the configuration and characteristics of the delta.

The Phase II experiment was scaled down from field to laboratory conditions to provide similarity in Froude number (i.e., the ratio of inertial to gravity forces), general sediment-transport regime and the aspect ratio. Extensive field and laboratory research has shown that the aspect ratio (here defined as normal flow depth to radial width of the delta) is a simple but very robust predictor of channel morphology in deltaic systems. As described in the report and due to the method of scaling (aspect ratio), the laboratory delta is expected to grow and maintain its surface by the same mechanisms as the field scale delta. The fines retention and the degree of grain size sorting seen in the experiment should be similar to that in the field scale delta.

Because one of the objectives of the Phase II experiment was to determine the potential for segregation of coarse and fine tailings in the delta, conditions were created to maximize segregation. High flows were used which would tend to transport more material to the pond area; during the falling phase of the Phase II experiment, the pool elevation was slowly decreased to promote delivery of tailings to the shoreline position and minimize deposition except for the coarsest material. Despite the attempt to maximize segregation, one of the major and firm conclusions from the Phase II experiment is that there will be a minimum of 30% (by mass) fines (passing mesh #200; particle sizes smaller than 74 micron) in the delta.





Date: February 13, 2015	NorthMet Project Waste Characterization Data Package
Version: 12	Page 35

Even under the most extreme plausible transport conditions, it was difficult to generate a deposit with less than 30% fines content.

It is important to note that the individual samples taken from the delta for analysis are just that; individual samples at specific locations. These results are useful for estimating the approximate degree of sorting in the delta and characterizing the tailings at any one location. However, they are not necessarily appropriate (as individual samples) for characterizing the tailings delta as a whole.

Barr used the SAFL report, supplemented with information from operational tailings basins, to reach important conclusions regarding data inputs that are necessary for the probabilistic water quality modeling.

- 1) Due to naturally developing slopes in the Phase I experiment, the 1% slope used for the field-scale design and therefore the water quality modeling, is reasonable.
- 2) It can be assumed that the tailings delta (portion of the tailings deposited above the water pond) is one zone. Although downstream fining is evident in the experiments and it has been documented in operational examples, the expected range of variation for the fines fraction (i.e., passing mesh #200) for Flotation Tailings (more than 50% is passing mesh #200) does not justify modeling two or more zones.
- 3) Of the tailings discharged aurally to form the NorthMet delta, the tailings delta will contain 100% of the coarse fraction (i.e., above mesh #200).
- 4) In any given year, the Flotation Tailings delta will on average have a fines fraction characterized by  $P_5 = 30\%$ ,  $P_{50} = 35\%$  and  $P_{95} = 40\%$  throughout the entire delta area. A normal distribution with mean and standard deviation of 0.3500 and 0.0304 respectively is used to describe the uncertainty in the percent fines in the delta as it is formed (Figure 5-1).
- 5) The average porosity of the tailings throughout the NorthMet delta is primarily a function of fluvial mixing rather than grain size distributions and is characterized by  $P_5 = 0.38$ ,  $P_{50} = 0.41$  and  $P_{95} = 0.45$ . A triangular distribution with lower, mode and upper values of 0.3668, 0.4012 and 0.4685 respectively is used to describe the uncertainty in the NorthMet delta porosity (Figure 5-2).
- 6) The average porosity of the tailings under the proposed pond is primarily a function of turbidity current and settling and is characterized by  $P_5 = 0.43$ ,  $P_{50} = 0.52$  and  $P_{95} = 0.56$ . A triangular distribution with lower, mode and upper values of 0.4049, 0.5602 and 0.5696 respectively is used to describe the uncertainty in the tailings porosity under the pond (Figure 5-3).



Date: February 13, 2015	NorthMet Project Waste Characterization Data Package
Version: 12	Page 36

- 7) The annual average solid fraction of the slurry discharged from the Beneficiation Plant will be a mixture of coarse tailings and fine tailings. This coarse tailings fraction (by mass) in the mixture will be characterized by  $P5 = 0.35$ ,  $P50 = 0.38$  and  $P95 = 0.41$ . Note that this distribution does not reflect what is stated in the SAFL report but is slightly lower (Attachment E). This is because the distribution parameters represent the coarse fraction from the most recent pilot plant testing (the grain size distribution results from Soil Engineering Testing, Inc., in April of 2011, Job number 7917). A normal distribution with mean and standard deviation of 0.3800 and 0.0182 respectively is used to describe the uncertainty in the percent coarse in the feed material (Figure 5-4).

The SAFL experiment was conducted using tailings from the initial pilot plant run (2005) and the report states that the fraction (by mass) of feed material that is coarse tailings (retained on the #200 mesh) is about 0.41 (ranging from 0.35 to 0.48). The most recent pilot plant testing, which was used to define the input distribution for the feed material, suggests that the mean is around 0.38. The fraction from the newest grain size distributions falls within the range reported in the SAFL report. Therefore, there is not a significant difference in the feed material between the initial pilot plant run and the recent pilot plant runs.

As outlined above in the SAFL report conclusions, the input distributions that define the porosity of the Flotation Tailings beach and the Flotation Tailings under the pond are primarily functions of fluvial mixing and settling rather than the grain size distribution. Therefore, the minor difference in the coarse fraction of feed material between the initial pilot plant run and the recent pilot plant runs is not anticipated to have a significant effect on these input parameters.

The input distribution that defines the fraction of fines retained in the delta could be a function of the make-up of the feed material. Lowering the coarse tailings fraction could cause the slope to be shallower, increasing the delta length and the fraction of fines in the delta. However, the difference in the coarse fraction of feed material between the initial pilot plant run and the recent pilot plant runs is very small and it is anticipated that this difference does not have a significant effect on this input parameter.

The conclusions drawn and listed above help define the other important hydraulic parameters needed to complete the water quality modeling. These other parameters are discussed in Section 10.2.1 of this document.

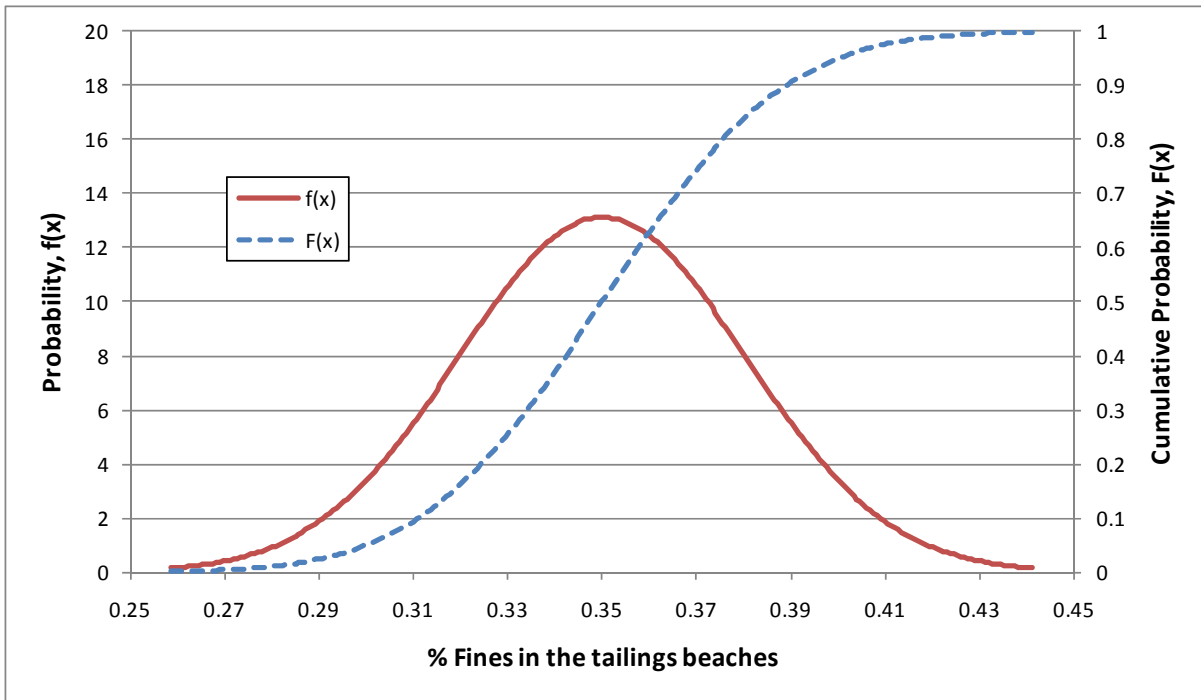

**Figure 5-1 Distribution for the Percent Fines in the Tailings Beaches**

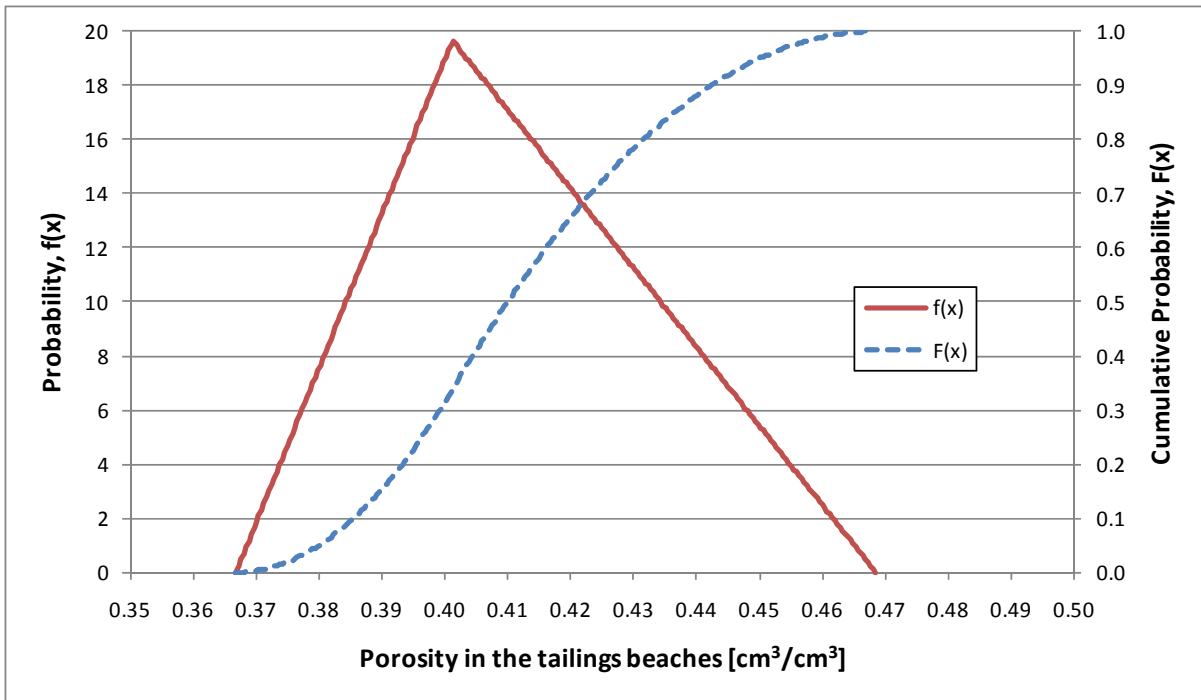

**Figure 5-2 Distribution for the Porosity in the Tailings Beaches**

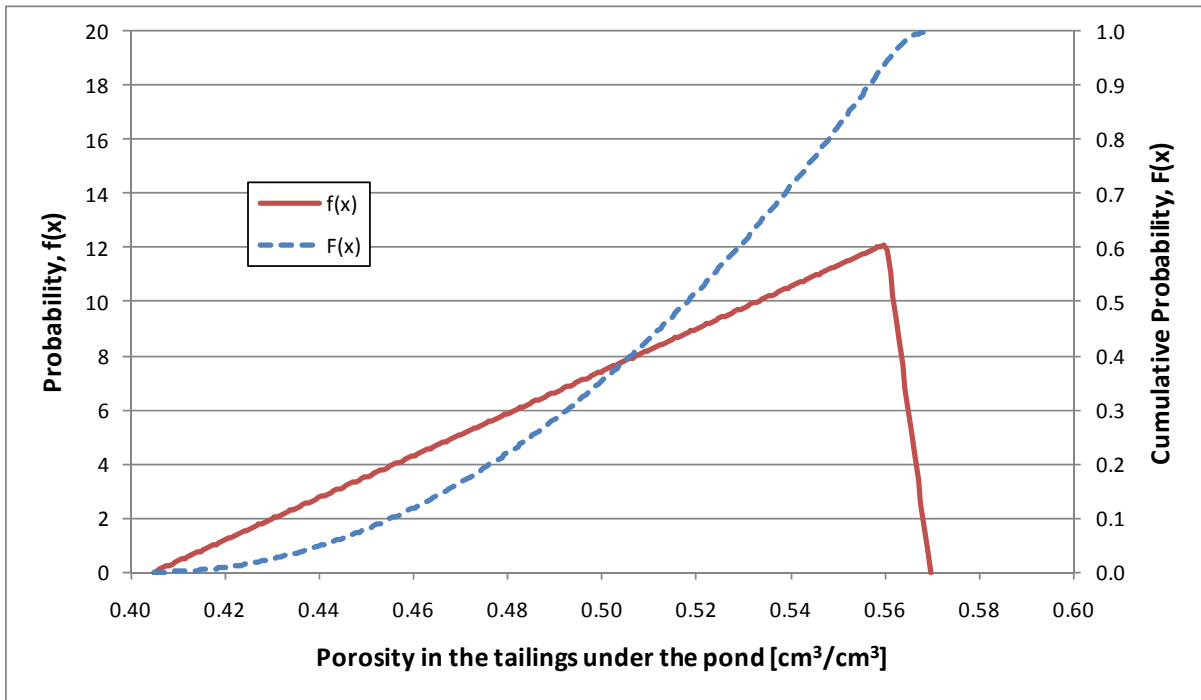

**Figure 5-3 Distribution for the Porosity under the Pond**

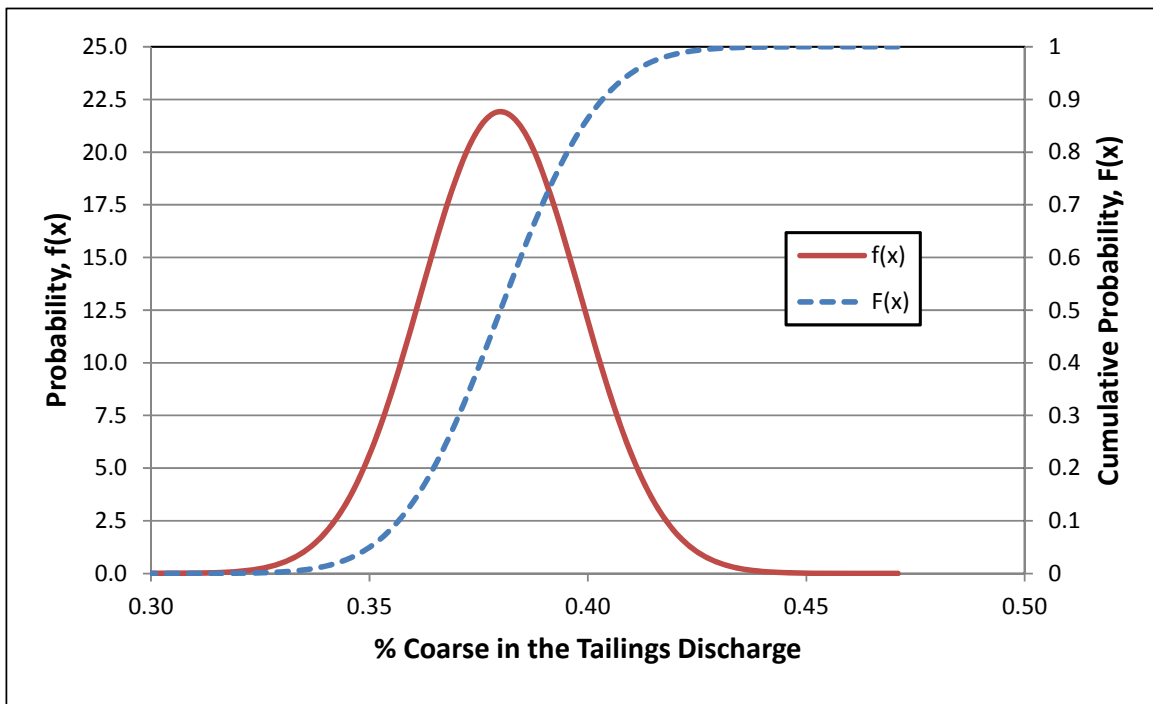

**Figure 5-4 Distribution for the Percent Coarse in the Feed Material**



Date: February 13, 2015	NorthMet Project Waste Characterization Data Package
Version: 12	Page 39

### **5.1.3.2 2011 Geochemical Update**

In order to accommodate the change in overall water quality modeling concept from deterministic to probabilistic, the results of ongoing kinetic testing were reevaluated and a new modeling approach was developed. This updated approach for the Flotation Tailings is similar to that developed for the waste rock, as discussed in Section 4.1.3.1 and presented in more detail in Attachment A. The application of this modeling approach is discussed in detail in Sections 10.1 and 10.4.

Previous interpretation of the humidity cell test results assumed that the rates of constituent leaching indicated by the humidity cells were free of solubility limitations due to the high liquid-to-solid ratios used in laboratory kinetic tests. Data from the humidity cells demonstrate that this is not the case for Flotation Tailings: total nickel release (leaching), for example, can increase by orders of magnitude even as oxidation and weathering of the sources of nickel decrease. A new approach was needed to account for the influence of solubility limitations on the humidity cell leaching rates.

Chemical constituents, including, major mineral components and trace metals, are released from host primary minerals as these minerals weather. The Project data indicated that after constituents are released from primary minerals, the concentrations of some of the chemical constituents in humidity cell tests were limited by solubility relationships with secondary minerals, while others were not. The release rates of constituents that appeared to be subject to solubility limitations were determined by identifying the likely mineral sources for each constituent using Project data and information from literature sources. The release rates of constituents that were potentially controlled by solubility relationships were identified by correlations with constituents in the same primary mineral host that were not controlled by solubility limitations.

This approach to estimating release rates relies on empirical analysis of the humidity cell data (for both tailings and waste rock) and data for metal content in the whole tailings samples (aqua regia digestion) and individual minerals (microprobe analysis of the minerals found in NorthMet waste rock and therefore tailings). The rates and relationships determined for the coarse and fine Flotation Tailings and the bulk LTVSMC tailings are therefore specific to this data set. The specific humidity cells used in this analysis, their tailings type, sulfur content and duration are shown in Large Table 4. The proposed approach for developing release rates for each constituent is outlined in Large Table 5 and described further in Section 10.1.

### **5.1.3.3 2011 Humidity Cell Trends Update**

A geochemical update report specific to the Flotation Tailings humidity cells (included as Attachment F) was submitted in 2011. A summary is presented in the following paragraphs.



Date: February 13, 2015	NorthMet Project Waste Characterization Data Package
Version: 12	Page 40

In the time since kinetic testing of pilot plant samples was initiated (tests summarized in the 2009 update report, Section 5.1.2), PolyMet has made refinements to the Beneficiation Plant flowsheet. The main refinements are an *Added Regrind* capacity and the ability to operate in *Split Cleaner Mode*, which are both included in the current Project Description (Reference (9)). The objective of these refinements is to optimize the flotation process and to allow for operational flexibility to produce a variety of concentrate products. With each process refinement PolyMet has performed pilot plant testing and has submitted the resulting tailings samples for the same geochemical testing. The humidity cells containing tailings produced by pilot plants in 2008 and 2009 are identified by the tailings source of “Pilot Plant 2”, “Pilot Plant 3”, and “SCAV” in Large Table 4.

The results of ongoing kinetic testing were used to reassess the assumed sulfate oxidation rates and pH conditions used in modeling the Flotation Tailings. In general, the testwork performed at various times and on tailings from various pilot plants shows similar relationships between sulfur content and sulfate release. All tests showed that sulfate release declined over time along with sulfur content, indicating that the decline in sulfate release may be due to reduction in available oxidation rates. This implies the sulfide oxidation reaction is non-zero order and that the use of initial oxidation rates in modeling remains conservative.

Some differences in pH trends have been observed between the initial (2005 & 2006) tests and subsequent (2008 & 2009) tests. The initial dataset showed that pH decreased to a level at which nickel released due to increased solubility (below about pH 7). This trend has not been observed to the same degree in more recent testwork, suggesting that there is more buffering capacity in the 2008 and 2009 tailings samples (stable pH > 7). Use of the first dataset to set the sulfur criterion for tailings management appears to be conservative.

PolyMet also initiated geochemical kinetic testing of composite samples of LTVSMC tailings in 2010, using the same testing methods as for the flotation tailings samples. The results from this testing show that LTVSMC tailings chemistry is dominated by buffering from the dissolution of carbonate minerals, with stable pH values between 7.3 and 8.1. Release rates for the primary constituents of concern have been stable since approximately 25 weeks of testing, providing good estimates of the average release rates for use in water quality modeling.

#### **5.1.4 2012 and 2014 Humidity Cell Trends Updates**

Analyses of the ongoing tailings humidity cell data were included in the updates submitted in 2012 (Attachment C, including data through February 2012), and 2014 (Attachment D, including data through August 2013). A summary of these documents is presented in the following paragraphs.

- No tests have generated pH lower than 6. .



Date: February 13, 2015	NorthMet Project Waste Characterization Data Package
Version: 12	Page 41

- Sulfur leaching rates have declined as sulfur is depleted, and differences in sulfur content explain the observed differences in sulfide oxidation rates and the degree to which pH is depressed.
- Samples with lower pH had accelerated leaching of nickel and cobalt, though only for the Pilot Plant 1 samples.
- Samples of LTVSMC tailings have shown stable leachate chemistry with slightly basic pH.

## 5.2 Flotation Tailings Management Concept

The concept for management of Flotation Tailings is:

- Process the ore using a bulk sulfide flotation process to minimize the amount of sulfides reporting to the FTB. This includes the use of copper-sulfate in the flotation process to promote additional sulfide flotation.
- Deposit tailings as a bulk tailing to avoid the lower saturation and higher release rates associated with the coarse-sized fraction.
- Maintain a pond in closure to minimize oxidation of Flotation Tailings. In closure, the beaches will cover about 425 acres, and the pond (including wetland area) will cover about 900 acres (Reference (10)).
- Amend the surface of the FTB dams and beaches, as well as the bed of the pond in closure, with bentonite to reduce oxygen penetration and minimize oxidation of Flotation Tailings.
- Install engineered systems at the toe of the FTB dams to collect water that has contacted the tailings and prevent seepage from migrating into the surrounding surficial materials.

Date: February 13, 2015	NorthMet Project Waste Characterization Data Package
Version: 12	Page 42

## 6.0 Hydrometallurgical Residue

The purpose of waste characterization for hydrometallurgical residue is to determine the geochemical characteristics of the hydrometallurgical residue generated by the Project and use those characteristics to develop a general hydrometallurgical residue management concept.

### 6.1 Reports

#### 6.1.1 Initial Report

The initial report (Reference (11)) was submitted in 2007. A summary of the report is presented in the following paragraphs.

Discrete and combined samples of the hydrometallurgical residues from pilot-testing have been tested for bulk solids characteristics, mineralogy and leaching characteristics. Combined samples with and without the gypsum filter residue were tested to allow for possible marketing of the gypsum filter residue.

Four of the residues (leach, solution neutralization, iron/aluminum and raffinate neutralization) were acidic. The leach residue consists dominantly of natrojarosite and hematite along with gypsum and residual plagioclase. The other three residues consist mainly of gypsum (96 to 99.8%). The magnesium residue was not acidic. It contains mostly gypsum (77%) but also 22% brucite (magnesium hydroxide), which is a source of alkalinity. Due to the presence of the magnesium residue, the combined residues were nonacidic and dominated by gypsum. Theoretically, the natrojarosite in the leach residues could consume buffering capacity resulting in acidic conditions of the combined residues in the future.

Humidity cell tests on residues showed an initial rapid flush of acidity and metals as process water was rinsed from the residues. As the tests proceeded, the individual leachates remained acidic but leaching of metals and acidity decreased reflecting dissolution of the residue. Sulfate concentrations remained elevated due to ongoing dissolution of gypsum.

Table 6-1 provides the maximum concentrations observed in the humidity cell testing on the combined residue, typically occurring in the initial test sample. These values were reported in the initial (Reference (11)) and in an expanded list of solutes prepared as an appendix to the water quality modeling document (Reference (12)).



**Table 6-1 Maximum Observed Hydrometallurgical Residue Humidity Cell Concentrations**

Constituent	Concentration (mg/L)
pH Range	6.6 – 8.5
Chloride	204
Sulfate	7,347
Aluminum (Al)	0.18 <sup>(1)</sup>
Antimony (Sb)	0.004
Arsenic (As)	0.004 <sup>(2)</sup>
Barium (Ba)	0.005
Beryllium (Be)	0.002
Boron (B)	0.14
Cadmium (Cd)	0.0004
Calcium (Ca)	626
Chromium (Cr)	0.05
Cobalt (Co)	0.005
Copper (Cu)	0.015
Iron (Fe)	0.4
Lead (Pb)	0.0005
Manganese (Mn)	0.0023
Magnesium (Mg)	1,040
Molybdenum (Mo)	0.14
Nickel (Ni)	0.098
Selenium (Se)	0.054
Silver (Ag)	0.0005
Sodium (Na)	1,250
Thallium (Tl)	0.0002
Vanadium (V)	0.002
Zinc (Zn)	0.01

(1) Maximum Al concentration from shake flask testing (not humidity cells)

(2) As concentration shown is for initial leachates for which maxima occurred for other constituents



Date: February 13, 2015	NorthMet Project Waste Characterization Data Package
Version: 12	Page 44

### **6.1.2 2009 Update**

A general geochemical update report (Reference (4) Section 5) was submitted in 2009. A summary of the report is presented in the following paragraphs.

The results of ongoing kinetic testing showed that leachate chemistry, including pH, is relatively stable until gypsum is completely leached, which results in decreasing sulfate leaching and changes to trace element leaching. Because the number of pore water volumes flushed in the ongoing tests far exceeds the pore water displacement that will occur in the lined and covered residue cells, these long-term effects likely do not represent site conditions. The initial maximum leachate concentrations and pH range shown in Table 6-1 will continue to be used as the basis for water quality modeling.

### **6.1.3 2011 Design Update**

The Hydrometallurgical Residue Facility (HRF) liner design has changed since the modeling for the DEIS. Currently, the proposed design is a double liner with leak detection. Therefore, it is expected that essentially no leakage will occur, or it will be detected and corrected. According to the Groundwater Impact Assessment Planning summary memo, it is assumed that the HRF will have negligible leakage and there is no compelling need to model the leakage from this source (Reference (13)). At final closure, the water in the HRF will be decanted and pumped to the FTB. Any water captured by the leakage system will also be pumped to the FTB. However, all of this water pumped to the FTB will be treated first at the WWTP at the Plant Site such that the FTB will not exceed water quality standards at the compliance points (Reference (14)).

Because the HRF can be assumed (for modeling purposes) to have no leakage and the water pumped from the HRF to the FTB during closure will be treated, there is no reason to model the chemical loading from the HRF. Therefore, a geochemical characterization of the hydrometallurgical residue was not necessary for the modeling of the SDEIS. Geochemical characterization of the hydrometallurgical residue was conducted, and the results of these analyses are described in the HRF Residue Management Plan (Reference (14)).

### **6.1.4 2013 Water Quality Update**

As part of the design for the Plant Site WWTP, the expected quality of the drainage from the HRF was compared to the water quality of the other modeled inflows to the WWTP. The humidity cell data from the initial report (Reference (11)) were used to determine the average concentrations observed in the “combined (with CuSO<sub>4</sub>)” residue test cell. This is the most likely representation of the waste material that will be placed in the HRF during operations. Average values for the constituents of interest were calculated for both data sets (residue and other inflows to the WWTP) after setting non-detect values to half the detection limit. The average values from the humidity cells likely approach the long-term steady state values for most of the constituents of interest. The average concentrations are shown in Table 6-2. This

information is used for the design of the WWTP, not for modeling the chemical loading from the HRF.

**Table 6-2 Average Observed Hydrometallurgical Residue Humidity Cell Concentrations**

Constituent	Concentration (mg/L) <sup>1</sup>
Alkalinity (as CaCO <sub>3</sub> )	27
Fluoride	0.2
Chloride	4
Sulfate	1600
Aluminum (Al)	0.012
Arsenic (As)	0.010
Barium (Ba)	0.002
Boron (B)	0.013
Cadmium (Cd)	0.002
Calcium (Ca)	580
Cobalt (Co)	0.005
Copper (Cu)	0.006
Iron (Fe)	0.016
Lead (Pb)	0.002
Manganese (Mn)	0.001
Magnesium (Mg)	32
Nickel (Ni)	0.008
Potassium (K)	0.3
Selenium (Se)	0.011
Sodium (Na)	20
Thallium (Tl)	0.00002
Vanadium (V)	<0.00022
Zinc (Zn)	0.003

(1) Average observed concentration in the combined residue with CuSO<sub>4</sub> humidity cell



Date: February 13, 2015	NorthMet Project Waste Characterization Data Package
Version: 12	Page 46

## **6.2 Hydrometallurgical Residue Management Concept**

The concept for management of hydrometallurgical residue is:

- add lime or limestone to the residue to avoid long-term acid generation (to be confirmed once hydrometallurgical plant operations are underway)
- place the residue in a double-lined facility with leak detection
- treat all of the water pumped and collected during dewatering
- cover the facility in reclamation to minimize water infiltration so that it is negligible



Date: February 13, 2015	NorthMet Project Waste Characterization Data Package
Version: 12	Page 47

## **7.0 Geochemical Parameters – Overburden**

This section covers geochemical parameters relating to overburden that are used in water quality modeling.

### **7.1 Leachate Water Quality – Unsaturated Overburden**

As described in Section 3.1.1 and Section 3.1.2 two different sampling campaigns and methods of analysis have yielded a consistent understanding of the geochemical behavior of the Unsaturated Overburden at the Mine Site. This material has been above the water table and in oxidizing conditions for millennia and has little potential for ongoing significant release of constituents of concern.

Unlike the modeling of waste rock described in Section 8.0, the quality of the water leaching from stockpiled Unsaturated Overburden is expected to be constant over time and is not a function of the quantity of stockpiled material. The leachate chemistry from a portion of the Overburden Storage and Laydown Area and other areas where Unsaturated Overburden is used as construction material, is represented by the results of the 2008 MWMP testing (Table 3-1). The results of this testing were used to develop probability distributions of leachate chemistry for constituents from Unsaturated Overburden. Uniform distributions were defined from the maximum and minimum concentrations reported in Reference (1). The ranges of the leachate chemistry are presented in Table 7-1.

### **7.2 Leachate Water Quality – Peat**

Similar to the Unsaturated Overburden, the quality of the water leaching from Peat stockpiled in a portion of the Overburden Storage and Laydown Area is modeled using the results of the 2008 MWMP testing (Table 3-1). The results of this testing were used to develop probability distributions of leachate chemistry for constituents from Peat. Uniform distributions were defined from the maximum and minimum concentrations reported in Reference (1). The ranges of the leachate chemistry are presented in Table 7-1.

Although peat has the potential to release mercury in drainage water when stockpiled, mercury was not included in the probabilistic model for several reasons: (1) there is a lack of comprehensive low level mercury data for all mine site wastes and water streams; (2) the primary source of mercury in northeastern Minnesota, including the Mine Site, is aerial deposition; and (3) experience at other mining operations in the region shows that mine pit water is generally below background concentrations with respect to mercury. Drainage from the peat portion of the OSLA will be monitored for mercury during operations and mitigation measures will be taken if necessary (Reference (15)).

**Table 7-1 Distributions for Unsaturated Overburden and Peat Leachate**

Constituent	Units	Unsaturated OB		Peat	
		Min <sup>(1)</sup>	Max <sup>(2)</sup>	Min <sup>(1)</sup>	Max <sup>(2)</sup>
Silver (Ag)	mg/L	0.000025	0.00005	0.000025	0.0014
Aluminum (Al)	mg/L	0.068	0.32	0.042	0.13
Alkalinity	mg CaCO <sub>3</sub> /L	4.6	13.1	8.5	82.7
Arsenic (As)	mg/L	0.0004	0.0032	0.0029	0.0044
Boron (B)	mg/L	0.0005	0.030	0.18	0.23
Barium (Ba)	mg/L	0.003	0.014	0.01	0.035
Beryllium (Be)	mg/L	0.0001	0.0002	0.0001	0.0002
Calcium (Ca)	mg/L	1.8	5.9	15.8	22.9
Cadmium (Cd)	mg/L	0.00005	0.00016	0.00002	0.00004
Chlorine (Cl)	mg/L	0.74	3.6	2.7	9.2
Cobalt (Co)	mg/L	0.00005	0.0016	0.00005	0.0007
Chromium (Cr)	mg/L	0.0001	0.0011	0.0001	0.001
Copper (Cu)	mg/L	0.005	0.0083	0.003	0.011
Fluoride (F)	mg/L	0.025	0.48	0.08	1.1
Iron (Fe)	mg/L	0.02	0.06	0.02	0.12
Potassium (K)	mg/L	0.66	1.3	1.5	5.7
Magnesium (Mg)	mg/L	0.66	2.1	7.8	10.9
Manganese (Mn)	mg/L	0.0075	0.11	0.059	0.19
Sodium (Na)	mg/L	1.8	4.3	4.2	47.3
Nickel (Ni)	mg/L	0.0008	0.0033	0.0015	0.0066
Lead (Pb)	mg/L	0.000025	0.00005	0.000025	0.00023
Antimony (Sb)	mg/L	0.00005	0.0011	0.0005	0.0007
Selenium (Se)	mg/L	0.0001	0.0006	0.0006	0.0009
Sulfate (SO <sub>4</sub> )	mg/L	1.7	16.5	68.3	93.4
Thallium (Tl)	mg/L	0.00001	0.00003	0.00001	0.00011
Vanadium (V)	mg/L	0.0004	0.0006	0.0025	0.0043
Zinc (Zn)	mg/L	0.002	0.006	0.0005	0.004

(1) Minimum value from MWMP tests. LOD/2 substituted for non-detects.

(2) Maximum value from MWMP tests. LOD substituted for non-detects.



Date: February 13, 2015	NorthMet Project Waste Characterization Data Package
Version: 12	Page 49

### **7.3 Leachate Water Quality – Saturated Overburden**

As discussed in Section 3.2, Saturated Overburden from the Mine Site has the potential to release constituents at levels that could have significant environmental impact. Accordingly, the Saturated Overburden material will be treated as Category 2/3 or Category 4 waste rock: placed in the temporary lined waste rock stockpiles and ultimately relocated to subaqueous placement in the East Pit.

Because the Saturated Overburden will be commingled with the Category 2/3 and Category 4 waste rock, it was not modeled as geochemically distinct from the waste rock. Rather, the Saturated Overburden added to the temporary waste rock stockpiles is conservatively assumed to behave identically to the Duluth Complex waste rock. The mass of Saturated Overburden added to each stockpile is considered to be an equal mass of the Duluth Complex waste rock.



Date: February 13, 2015	NorthMet Project Waste Characterization Data Package
Version: 12	Page 50

## 8.0 Geochemical Parameters – Waste Rock

This section covers geochemical parameters relating to waste rock that are used in water quality modeling.

### 8.1 Laboratory Release Rates

An updated methodology for interpreting the results of the NorthMet humidity cell tests is described in Section 4.1.3.1 and Large Table 2, based on the methods proposed in Attachment A. The specific methods used to develop probability distributions for the various constituents and waste rock categories are detailed here. The probability distributions discussed in this section are presented in Large Table 6 through Large Table 10 and shown in Large Figure 1 through Large Figure 22.

In general, the release rates described in this section apply to nonacidic conditions for all Duluth Complex waste rock categories and ore. The effects of acidification are addressed in Section 8.2.5 below. For Virginia Formation Category 4 waste rock, acidic conditions were observed almost immediately in the humidity cell tests and the effects of acidification are represented in the methods described here.

#### 8.1.1.1 Sulfate Release Rates for Category 1, Category 2/3 and Ore

As described in Attachment A and shown in Large Table 2, the release of sulfate from oxidation of sulfide minerals is a primary driver for modeling the release of many other constituents. This section describes the methods for modeling the sulfate release rates for each category of waste rock.

#### 8.1.1.2 Linear Regression Analysis

Laboratory data from NorthMet humidity cells show that there is a strong correlation between sulfur content and average nonacidic sulfate release. Data from all Duluth Complex NorthMet humidity cells are summarized in Figure 8-1 and Figure 8-2. The Category 4 Virginia Formation humidity cells did not experience significant nonacidic conditions and are therefore not presented here. As is evident from the data, the correlation between sulfur content and average sulfate release is strongest for Category 1 and Category 2/3 waste rock. These waste rock categories contain relatively low amounts of sulfur and do not rapidly become acidic (Category 1 waste rock never becomes acidic).



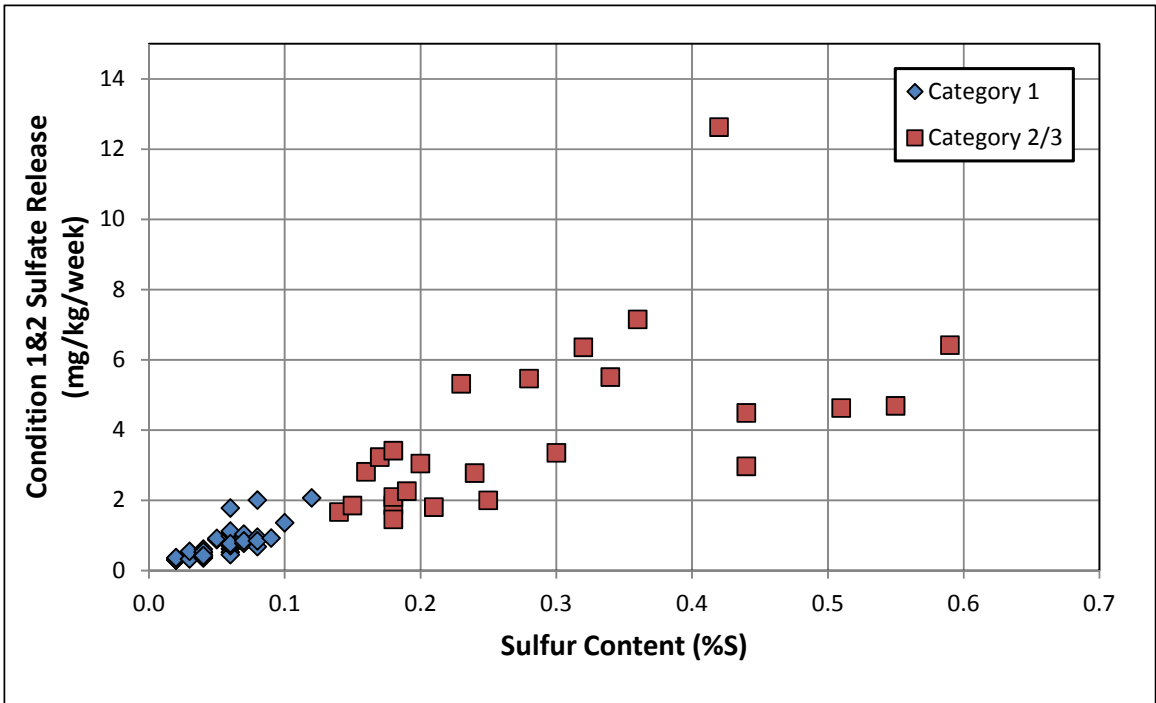

Figure 8-1 Sulfur Content versus Nonacidic Sulfate Release for Category 1 and 2/3

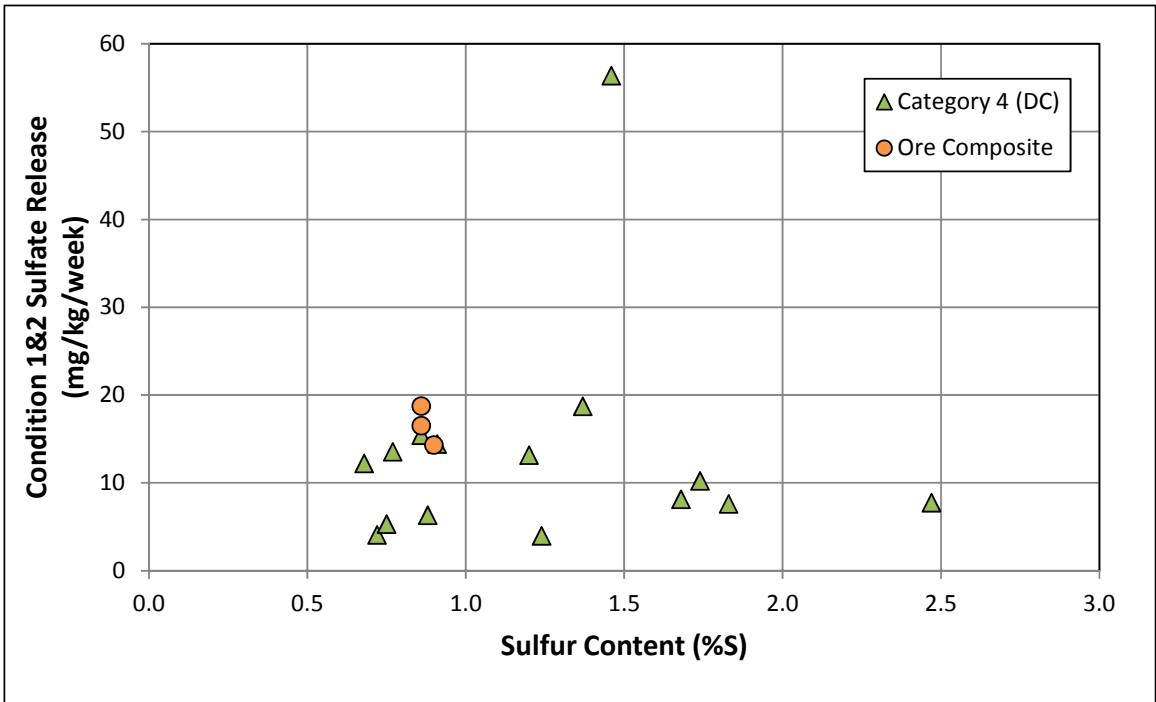

Figure 8-2 Sulfur Content versus Nonacidic Sulfate Release for Duluth Complex (DC) Category 4 and Ore

Sulfate release for the Duluth Complex Category 4 waste rock and for the ore composites does not appear as well-correlated with sulfur content, especially for sulfur contents above about 1.5%. At sulfur contents below 1.5%, however, and excluding two visually-determined outlier values (3.93 mg/kg/week at 1.24%S and 56.3 mg/kg/week at 1.46%S), the Duluth Complex Category 4 and ore data appear to follow the same trend as the lower-sulfur Category 1 and Category 2/3 data (Figure 8-3), with a correlation between sulfur content and average nonacidic sulfate release.

This section describes the development of a mathematical model for estimating nonacidic sulfate release rate from Category 1 and Category 2/3 waste rock and ore as a function of sulfur content. Such a model is needed in order to estimate the oxidation rates from the exposed mine pit walls, which primarily consist of these rock types and have sulfur content that varies with elevation (see Section 4.3.2). This model is especially important for modeling the wall rock classified as ore, which has average sulfur contents around 0.5% in the final West Pit highwall (Figure 4-18), compared to 0.9% sulfur in the ore humidity cell tests. Note that this model will not be used for sulfate release from the Category 4 Duluth Complex or Virginia Formation rock.

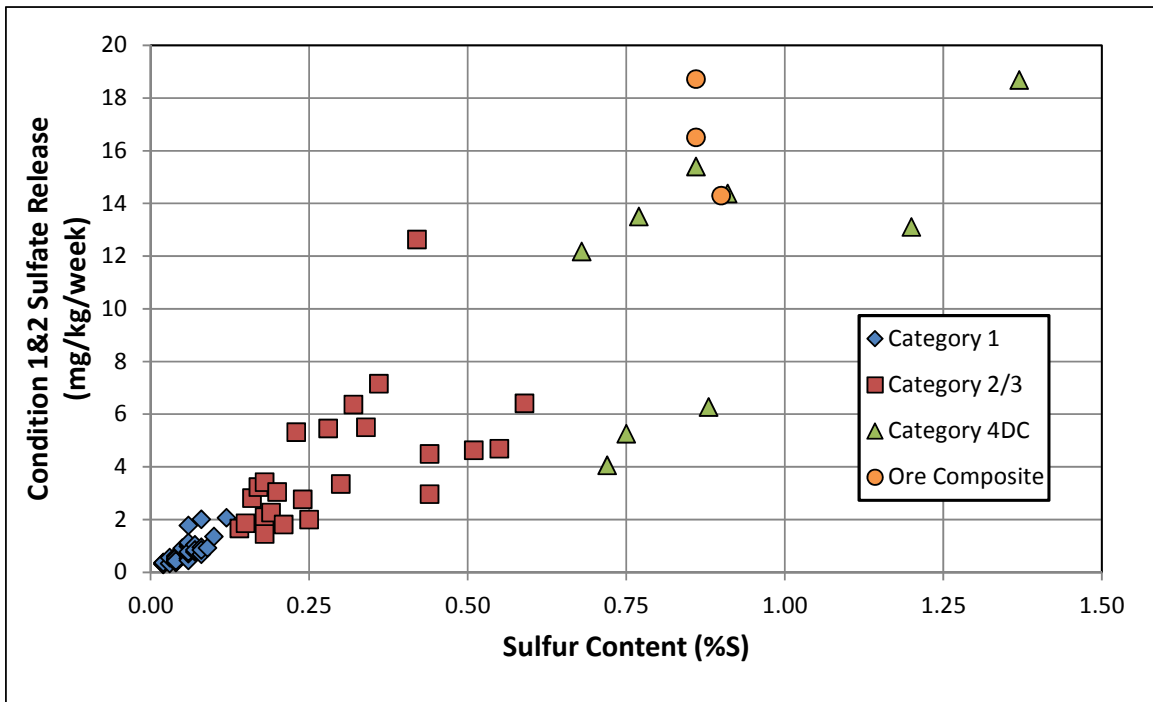

Figure 8-3 Sulfur Content versus Nonacidic Sulfate Release for Duluth Complex (DC) Samples with less than 1.5% Sulfur (Outliers Removed)



Date: February 13, 2015	NorthMet Project Waste Characterization Data Package
Version: 12	Page 53

As a relatively simple mathematical model, linear regression by the method of ordinary least squares is used to develop a relationship between the sulfur content and nonacidic sulfate release of the form

$$R = aS + b \quad \mathbf{8-1}$$

where  $R$  is the sulfate release rate [mg/kg/week],  $S$  is the waste rock sulfur content by mass [%S] and  $a$  and  $b$  are the slope and intercept of the regression line, respectively. The resulting regression parameters and their confidence intervals are shown in Table 8-1 for each category of waste rock considered separately. The Duluth Complex Category 4 samples and the ore composites are considered together in this analysis because they overlap sulfur content ranges.

Rock with zero sulfur content could be reasonably expected to release zero sulfate. Given the initial geochemical premise of zero sulfate release from rock that contains no sulfur, it is hypothesized that the intercept of the general model could be zero. Therefore, the regression analysis was performed both with the general model shown in Equation 8-1 and with a fixed zero intercept (Equation 8-1 with  $b = 0$ ). If the zero-intercept model can be reasonably used, the goodness of fit of this and the general model can be compared to assess whether one model accounts for a greater proportion of the variance in sulfate release rate. Results of the regression analysis for each rock category considered separately, and the combined data set, are presented in Table 8-1.

For all three sample groups (Category 1, Category 2/3, and Duluth Complex Category 4 plus ore) considered individually, the linear regression intercept parameter  $b$  is not significantly different from zero at the 5% significance level (p-values well above 0.05). In all three cases, the zero intercept models have a goodness-of-fit that is nearly identical to the general models (as measured by the root mean square error or RMSE, see footnote to Table 8-1) and account for the same proportion of the variance in the sulfate release data set.

Even though the statistical tests cannot prove that the intercept parameter is equivalent to zero, the zero-intercept model is selected going forward because it is consistent with the linear relationship that a zero sulfur content rock will have a zero sulfate release.

**Table 8-1 Linear Regression Results for Sulfate Release**

Category	Model	Par.	Units	Value	Std. Error (par.)	95% CI	RMSE <sup>1</sup> (model)
Category 1	general	a	$\frac{mg}{kg \times week \times \%S}$	14.45	1.98	10.43 - 18.47	0.28
		b	$\frac{mg}{kg \times week}$	-0.04	0.12	-0.27 - 0.2	
	zero intercept	a	$\frac{mg}{kg \times week \times \%S}$	13.86	0.80	12.24 - 15.48	0.28
Category 2/3	general	a	$\frac{mg}{kg \times week \times \%S}$	10.71	3.12	4.25 - 17.17	1.96
		b	$\frac{mg}{kg \times week}$	0.88	0.99	-1.17 - 2.92	
	zero intercept	a	$\frac{mg}{kg \times week \times \%S}$	13.22	1.29	10.57 - 15.88	2.00
Category 4 (Duluth) (<1.5%S) plus ore	general	a	$\frac{mg}{kg \times week \times \%S}$	12.07	6.91	-3.33 - 27.47	4.17
		b	$\frac{mg}{kg \times week}$	1.86	6.34	-12.26 - 15.98	
	zero intercept	a	$\frac{mg}{kg \times week \times \%S}$	14.05	1.38	11.02 - 17.08	4.19
Combined data set (Duluth, <1.5%S)	general	a	$\frac{mg}{kg \times week \times \%S}$	13.84	0.76	12.32 - 15.36	2.05
		b	$\frac{mg}{kg \times week}$	0.03	0.31	-0.59 - 0.66	
	zero intercept	a	$\frac{mg}{kg \times week \times \%S}$	13.89	0.58	12.74 - 15.04	2.05

(1) The root mean square error (RMSE) is a goodness of fit parameter used for comparing goodness of fit of different models for the same data set. The RMSE is sensitive to the sample size and therefore is not comparable between data sets.

### 8.1.1.3 Combining Data Sets

The fitted slope parameters for the three sample groups shown in Table 8-1 are comparable and the 95% confidence intervals mostly overlap. Because these rock groups share a similar bulk rock composition and are only categorized by differences in sulfur content, it is reasonable to evaluate whether they can be treated as a single data set for the purpose of evaluating sulfate release. If the rock categories can be combined for this analysis, the larger data set will decrease the uncertainty in the estimate of the sulfate release rate and allow for modeling sulfate release at intermediate sulfur contents (i.e., ore wall rock with sulfur content ranging from 0.5% to 0.8%). The statistical hypothesis test for equivalence of the slope parameters, using the standard error values shown in Table 8-1, yields a test statistic  $z$  given by Equation 8-2:

Date: February 13, 2015	NorthMet Project Waste Characterization Data Package
Version: 12	Page 55

$$z = \frac{a_i - a_j}{\sqrt{SE_i^2 + SE_j^2}} \quad 8-2$$

Larger z values indicate a greater difference between the two slope parameters and a lower likelihood that they are equal to one another. For example, a z value of 1.96 corresponds to a p-value of 0.05 (two-tailed normal test for z), indicating that the two slope parameters are significantly different at the 5% significance level. Comparing the data sets two at a time, the calculated z values are:

- Categories 1 and 2/3: 0.42 for zero intercept; 0.31 for general model
- Categories 1 and 4 (Duluth, <1.5%S) plus ore: 0.12 for zero intercept; 0.33 for general model
- Categories 2/3 and 4 (Duluth, <1.5%S) plus ore: 0.44 for zero intercept; 0.18 for general model

Using a two-tailed normal test for z and a 5% significance level  $\alpha$ , the null hypothesis (that the slope parameters are equal to one another) cannot be rejected for any of these six hypothesis tests (p-values of 0.66 to 0.91 for zero-intercept model and 0.31 to 0.86 for the general model). Data from the Category 1, Category 2/3, and Category 4 (Duluth, <1.5%S) plus ore humidity cells are therefore assumed to come from the same population, and are combined to assess sulfate release as a function of sulfur content.

The combined data was analyzed using the ordinary least squares method and the zero-intercept model. Results for the combined data are shown in Table 8-1. The general model has an intercept value that does not significantly differ from zero and the same RMSE value as the zero-intercept model. Finally, the z-value for a test of differences in the slopes between the general model and the zero-intercept model for the combined data is 0.052, indicating that the two models may not significantly differ in their slopes (p-value of 0.96).

Even though the statistical tests cannot prove there is no difference between the slopes for the different rock categories, the combined zero-intercept model is selected going forward because it provides a consistent method for modeling Duluth Complex rock at sulfur contents across the range of expected conditions in the pit walls.

#### 8.1.1.4 Testing Assumptions of Ordinary Least Squares

Ordinary least squares, like most statistical methods, requires several assumptions about the characteristics of the dataset in order to be fully valid:

1. The residuals (difference between model-predicted release rate and observed release rate) have a mean value of zero;

2. The residuals fit a normal distribution; and
3. The residuals show no significant correlation with the dependent variable (%S) (i.e., they are not heteroscedastic).

These assumptions were tested in the statistical software Minitab 17 to evaluate the validity of the above results for the combined zero-intercept model: First, a z-test indicated that the residuals of the zero-intercept model do not significantly differ from zero ( $p > 0.5$ ), so the data are consistent with the first assumption. However, further testing showed that the data do not conform to the second and third assumptions. An Anderson-Darling normality test indicated that the residuals are not normally distributed ( $p < 0.005$ ; Figure 8-4, left figure). The absolute values (magnitude) of the residuals also showed a significant linear relationship with %S ( $p < 0.001$ ,  $R^2 = 52\%$ ; Figure 8-4, right figure), indicating heteroscedasticity. Overall, the latter two findings indicate that the data do not conform to the assumptions of ordinary least squares, so an alternative method to ordinary least squares should be applied.

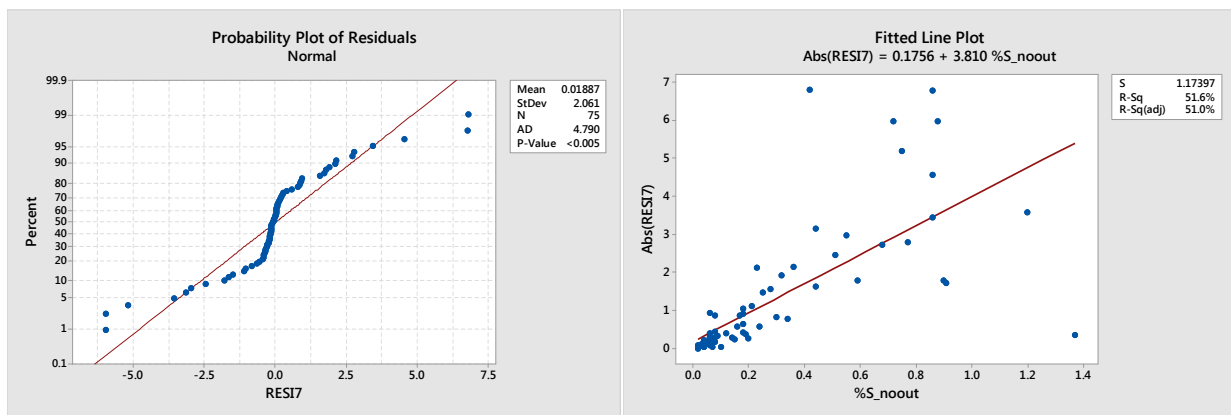

**Figure 8-4 Residuals Testing for the Regression Model for Combined Duluth Complex Data**

### 8.1.1.5 Correction for Non-Constant Variance

It is clear from Figure 8-4 that the sulfate release data are heteroscedastic; the dispersion of the data around a best-fit line increases as sulfur content increases, violating the third basic assumption of the ordinary least squares regression model. To correct this problem the data can be analyzed using weighted linear regression (Reference (16)), a method that assumes that the standard deviation of the model residuals  $e_i$  (error between the observed data and the best-fit line) increases linearly in proportion to the independent variable (sulfur content):

$$Std(e_i) = \kappa S_i \quad \mathbf{8-3}$$

where  $\kappa$  is the unknown proportionality constant. For the linear regression model with zero intercept, the slope parameter  $a$  can be calculated from

Date: February 13, 2015	NorthMet Project Waste Characterization Data Package
Version: 12	Page 57

$$a = \frac{1}{n} \sum_{i=1}^n \left( \frac{R_i}{S_i} \right)^2 \quad \mathbf{8-4}$$

where  $R_i$  and  $S_i$  are the sample sulfate release rate and sulfur content previously defined. The proportionality constant  $\kappa$  is estimated as shown in Equation 8-5 and the standard error of the slope parameter  $a$  is calculated from Equation 8-6.

$$\kappa = \sqrt{\frac{1}{n-1} \sum_{i=1}^n \left( \frac{R_i}{S_i} - a \right)^2} \quad \mathbf{8-5}$$

$$\sigma_a = \frac{\kappa}{\sqrt{n}} \quad \mathbf{8-6}$$

Because  $a$  is calculated as the sum of  $n$  independent random variables, the Central Limit Theorem suggests that  $a$  will be well-modeled by a normal distribution regardless of the distribution of the model residuals.

The analysis described above yields a slope parameter  $a$  equal to 13.92 [mg/kg/week/%S] with standard error  $\sigma_a$  equal to 0.581 [mg/kg/week/%S]. This single-parameter best-fit line is shown for the NorthMet humidity cell data in Figure 8-5 and the normalized residuals are shown in Figure 8-6. The mean of the residuals is not significantly different from zero ( $p > 0.9$ ), and the normalized residuals show no significant relationship with %S ( $p > 0.3$ ). Because no particular distribution of the residuals is assumed for weighted least squares to be valid, these tests indicate that the method of weighted least squares was successful in addressing the problem of heteroscedasticity and that the resulting relationship can be effectively applied in probabilistic modeling. Note that the 95% confidence interval for  $a$  shown in Figure 8-5 is 12.78 to 15.06 [mg/kg/week/%S], a range that includes all of the zero-intercept slope estimates for the individual rock categories as presented in Table 8-1.

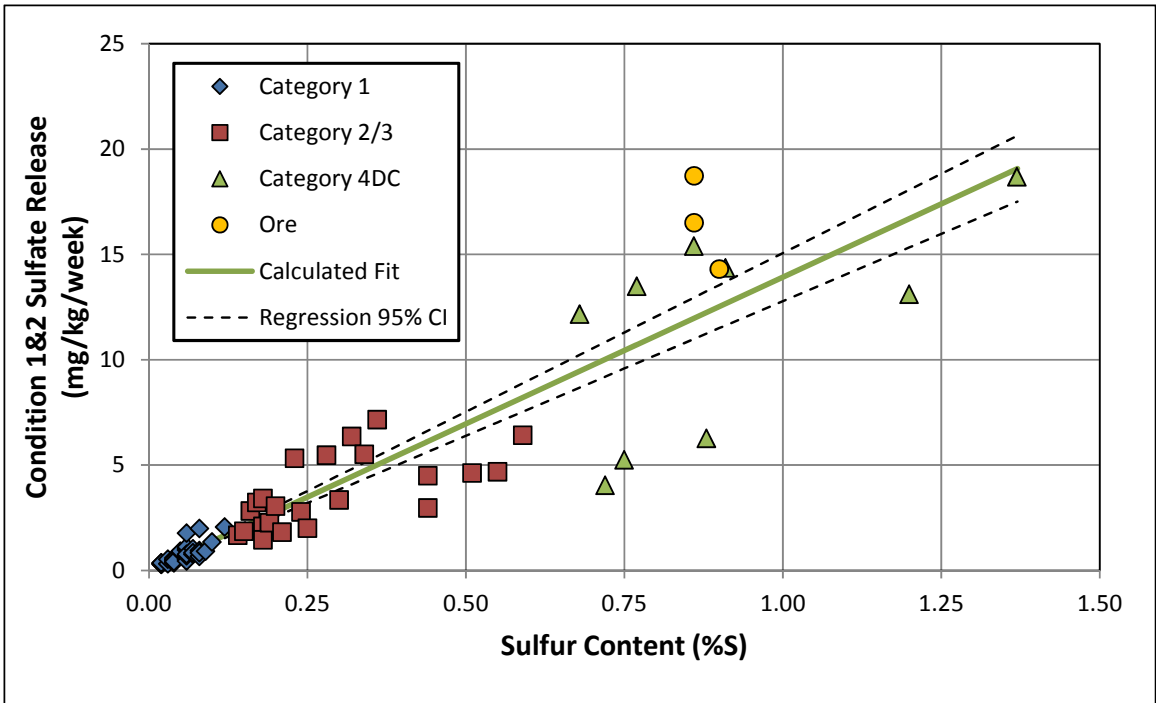

Figure 8-5 Weighted Linear Regression Fit for Combined Duluth Complex Data

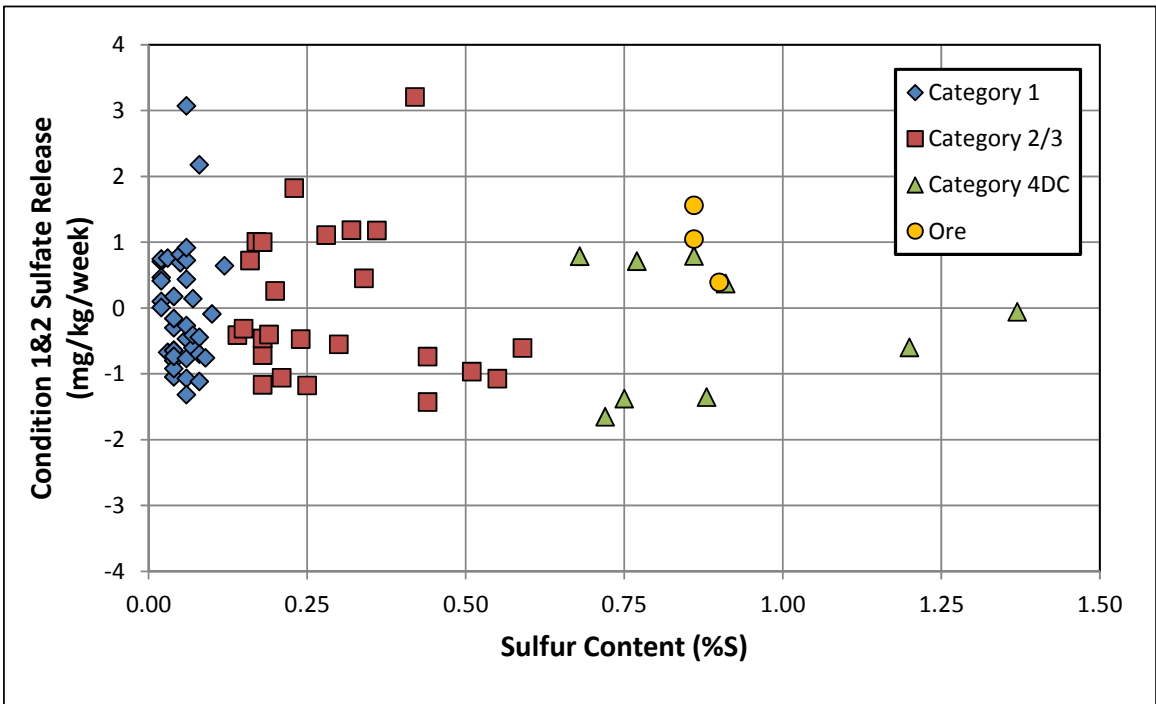

Figure 8-6 Normalized Residuals from Weighted Linear Regression Fit





Date: February 13, 2015	NorthMet Project Waste Characterization Data Package
Version: 12	Page 59

### 8.1.1.6 Application to Probabilistic Modeling

The sulfate release rate used in the probabilistic water quality model for each waste rock category can be understood as the average release rate from an entire waste rock stockpile or category of wall rock. Each stockpile will contain millions of tons of waste rock, whereas the humidity cells contain approximately one kilogram of waste rock each. The stockpile sulfate release, therefore, is equivalent to an average release rate over billions of combined humidity cells. The uncertainty in the average sulfate release rate is not the same as the possible variability over the population of humidity cells.

Using the regression analysis described above, the average sulfate release rate from a given rock category can be calculated as a function of the average sulfur content from Equation 8-7. This is simply the zero-intercept equation for linear regression (Equation 8-1)

$$R = aS \qquad \qquad \qquad \mathbf{8-7}$$

The uncertainty in the slope parameter  $a$  is represented with the normal distribution developed above and shown in Figure 8-7. The average stockpile sulfur content is equal to the weighted average value from the Block Model presented in Section 4.3.2, considered to be deterministic (known). This method of modeling sulfate release is only applied to Category 1 and Category 2/3 waste rock and ore in the water quality modeling based on the linear model developed for sulfur contents less than 1.5%. The sulfate release rate for all other waste rock categories is modeled as described in Section 8.1.2 for “constituents with release rates determined directly from humidity cells.”

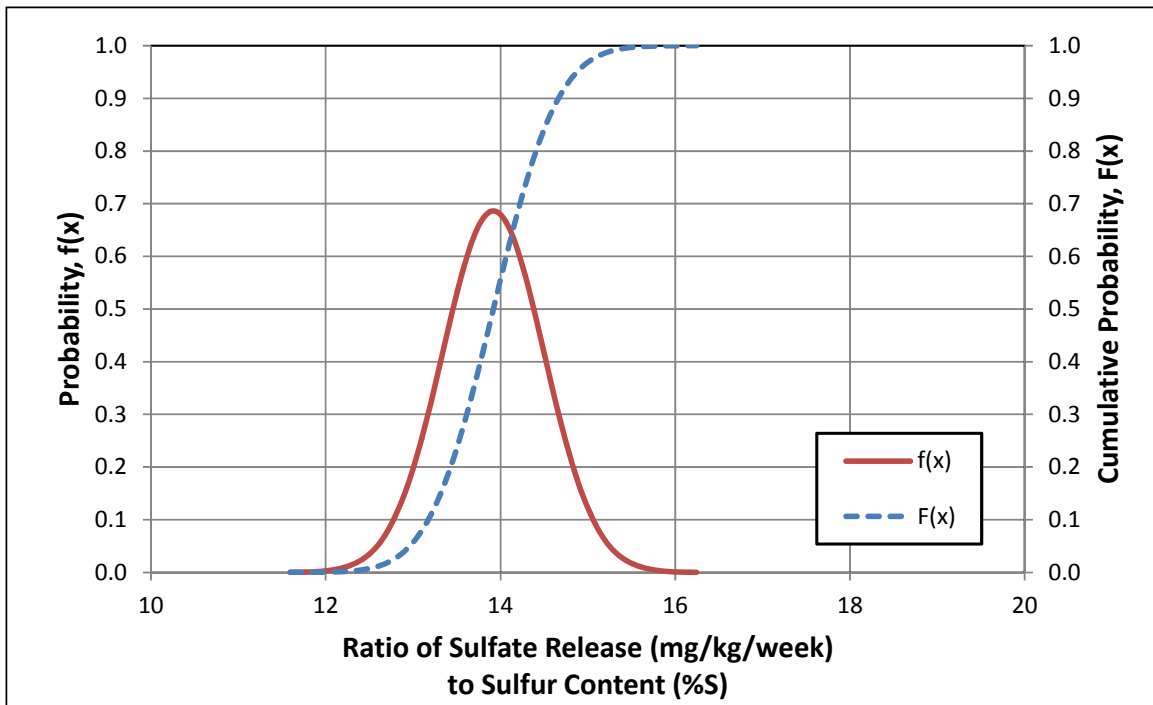

**Figure 8-7 Distribution for the Sulfate Release Slope for Category 1, Category 2/3 and Ore**

### 8.1.2 All Other Release Rates

The methods for modeling the uncertainty in laboratory-scale release rates for all constituents other than sulfate are described below.

As discussed in Section 4.1.3.1 and Attachment A, data from the NorthMet humidity cells demonstrate that solubility limitations or concentration capping effects can reduce or increase metal leaching rates from the humidity cells, especially for constituents that are highly sensitive to small changes in leachate pH. The modeling approach described here has been developed in consultation with the Co-lead Agencies to account for the influence of concentration caps on the humidity cell leaching rates.

Chemical constituents, including, major mineral components and trace metals are released from host primary minerals as these minerals weather. The Project data indicated that after constituents are released from primary minerals, the concentrations of some of the chemical constituents in humidity cell tests were limited by solubility relationships with secondary minerals, while others were not. The release rates of constituents that appeared to be subject to solubility limitations were determined by identifying the likely mineral sources for each constituent using Project data and information from literature sources. The release rates of constituents that were potentially controlled by solubility relationships were identified by correlations with constituents in the same primary mineral host that were not controlled by solubility limitations.



Date: February 13, 2015	NorthMet Project Waste Characterization Data Package
Version: 12	Page 61

This approach to estimating release rates relies on empirical analysis of the humidity cell data and data for metal content in the drill core samples (aqua regia digestion) and individual minerals (microprobe analysis). The rates and relationships determined for the different waste rock categories are therefore specific to this data set. The specific humidity cells used in this analysis, their rock type, sulfur content, and test duration are shown in Large Table 1. The proposed approach for developing release rates for each constituent is outlined in Large Table 2. Distribution parameters and data set date ranges used in the probabilistic modeling are shown in Large Table 6 through Large Table 10 and Large Figure 1 through Large Figure 22.

### 8.1.2.1 Release Rates from Humidity Cells

For all constituents with release rate methods identified by “XX Rate” in Large Table 2, probability distributions have been developed directly from the humidity cell data. For each cell a temporal average release rate has been determined for nonacidic conditions (described as Condition 1 and Condition 2 in Large Table 1) and acidic conditions, as applicable (described as Condition 3 in Large Table 1, the period of acidic conditions prior to any decrease in sulfate release). Non-detect samples have been taken as equal to the detection limit. As previously noted, the release rates determined in this manner for the Virginia Formation Category 4 waste rock and some constituents for the Category 2, 3 and 4 Duluth Complex waste rock are for acidic conditions.

A probability distribution has been fit to the sample data set of average release rates (one per humidity cell) applicable for the specific geology and waste rock category. The complete range of release rates observed in the humidity cell testing has been assumed to represent the possible average release rate from an entire waste rock stockpile. Except as discussed in Section 8.1.1.1 for sulfate, no attempt has been made to weight the humidity cell data by sulfur content or otherwise bias the determined release rates towards the expected average conditions in the field. This results in conservatively wide ranges for the modeled release rates relative to the likely average field conditions.

For a group of trace metals in the Category 1 waste rock (Ag, As, B, Be, Cr, Pb, Se, Tl, and V), the large number of non-detects in the humidity cell dataset warrants additional consideration. For these constituents, the average release rates for each humidity cell have been determined with a more detailed consideration of the effects of non-detect data for the time period of data indicated in Large Table 6. This calculation made use of the ProUCL software, an EPA-approved software for the analysis of non-detect data.

- For humidity cells where all analyses results in detected values, the leachate concentration was calculated as a simple average.
- For humidity cells with at least 6 total detected values, ProUCL was used to estimate the mean leachate concentration using the nonparametric, Kaplan-Meier Method.



Date: February 13, 2015	NorthMet Project Waste Characterization Data Package
Version: 12	Page 62

- For humidity cells with less than 6 total detected values, ProUCL could not be used. The average leachate concentration was calculated from all data, substituting zero for the non-detect values.
- For humidity cells with no detected values, the average leachate concentration was assumed to be zero.
- The resulting estimated average leachate concentrations (one for each humidity cell) were converted to release rate units (mg/kg/week) using the sample mass and average leachate volume. For Se, the resulting release rates were divided by the average sulfate release rates in the corresponding humidity cells to calculate the Se/SO<sub>4</sub> ratio.
- A lognormal distribution was fit to the resulting release rate values.

These same methods have been applied to a smaller group of constituents (B, Cr, Tl) for the other Duluth Complex waste rock categories for nonacidic conditions only.

A similar method for considering the effect of non-detects has been used to develop the Sb release rate for Category 1 waste rock, but using smaller MDNR-style reactor experiments due to Sb contamination in the NorthMet humidity cells.

- The time period isolated for this analysis was the first 80 weeks of testing. This is shorter than the time period used for analysis of humidity cell data because of the more-rapid oxidation and release that is observed in the MDNR-style reactors due to the finer material.
- Only reactors with sulfur content less than 0.12% (equivalent to Category 1 waste rock) were used; in addition, only reactors with the smallest size fraction (passing 100 mesh) are used, consistent with MDNR testing methods. There are two reactors meeting these criteria [from samples DDH-00-334C (640-660) and DDH-00-367C (290-310)].
- Only laboratory analyses using the ICP-MS method were used, with a typical detection limit of 0.1 µg/L.
- The resulting data set (20 samples from each reactor, 40 samples total) were combined into a single data set and ProUCL was used to estimate the mean leachate concentration using the nonparametric, Kaplan-Meier Method.
- The resulting mean and standard deviation concentrations were converted to release rate units (mg/kg/week) using the sample mass (75g), average leachate volume (182 mL), and the MDNR-developed release rate conversion between reactors and humidity cells (humidity cell rate = reactor rate x 0.34) (Reference (17)). These parameters were assumed to describe a lognormal distribution for the Sb release rate from Category 1 waste rock.

For ore, the “ore composite” humidity cells have been used to define probability distributions for the material in the Ore Surge Pile (except for sulfate as discussed in Section 8.1.1.1).

These humidity cells represent blended samples, similar to the mixed material that will be in the stockpile. For modeling of wall rock as discussed in Section 9.1, Category 2/3 humidity



Date: February 13, 2015	NorthMet Project Waste Characterization Data Package
Version: 12	Page 63

cell distributions are used for the ore wall rock rather than the “ore composite” humidity cell distributions. This method more accurately represents the range of variability in release rates that is expected across the unmixed ore wall rock.

### 8.1.2.2 Release Rates from Humidity Cell Release Ratios

For all constituents with release rate methods identified by “XX/XX Rate” in Large Table 2, probability distributions have been developed from the ratio of release rates in the NorthMet humidity cells. For each cell a temporal average release rate ratio (ex. the ratio of average Mn release to average SO<sub>4</sub> release) has been determined for nonacidic conditions (Condition 2 in Large Table 1). A probability distribution has been fit to the population of average release rate ratios (one per humidity cell) applicable for the specific geology and waste rock category. The actual release rate for the constituent is simulated by multiplying the randomly-selected release rate ratio by the randomly-selected release rate of the constituent in the denominator (ex. Mn release rate = Mn/SO<sub>4</sub> release ratio x SO<sub>4</sub> release rate). Release rates under acidic conditions are modeled using the acidity factor to increase the SO<sub>4</sub> release rate (and correspondingly increase the ratioed constituent release rates) as discussed in Section 8.2.5. As discussed above for the release rates themselves, the complete range of release rate ratios observed in the humidity cell testing has been conservatively assumed to represent the possible average release rate ratio from an entire waste rock stockpile or category of pit wall, with no weighting or relationship to sulfur content. Release ratios for ore have been developed from the ore composite and Category 2/3 humidity cells as described above.

### 8.1.2.3 Release Rates from Solid Ratios

For all constituents with release rate methods identified by “XX/XX” and data sources other than “HCT” in Large Table 2, probability distributions are developed from the solids content data in the NorthMet drill core database. For each constituent, a probability distribution for the solids ratio (ex. ratio of Cu/S in the whole rock analysis) is fit to the population of observed solids ratios applicable for the specific geology and waste rock category.

For constituents with “Aqua Regia” identified as the source data, the entire NorthMet drill core database from 2005 to 2010 has been used to develop distributions, not just the analysis of the humidity cell samples. This database forms the basis for the Block Model and includes approximately 18,800 individual samples. Each sample is identified as either waste rock or ore based on PolyMet’s economic criteria as of May 2011 and is classified by rock category, rock type and geologic unit. Only those samples in the drill core database identified as waste rock have been used to develop distributions for the metals content applicable to the waste rock stockpiles (and corresponding portions of the pit walls); only samples identified as ore have been used to develop distributions applicable to the Ore Surge Pile (and ore portions of the pit walls).



Date: February 13, 2015	NorthMet Project Waste Characterization Data Package
Version: 12	Page 64

The NorthMet drill core database includes samples collected from outside of the proposed pit shells and does not necessarily represent the expected abundance of each rock type or geologic unit in the actual waste rock or ore. For example, 6.3% of the Category 1 drill core samples are from the combined Units 4 and 5, but material from these units makes up 21.3% of the Category 1 waste rock according to the Block Model. To correct for this difference between the drill core data and the Block Model, all analysis of the drill core aqua regia data was performed by weighting each sample according to the quantity of each geologic unit in each waste rock category and the ore in the Block Model. The influence of each geologic unit on the statistics described below is therefore consistent with the Block Model.

Because of the large number of samples available in the NorthMet drill core database, it is reasonable to assume that the weighted mean solids content (and solids ratio) from the database represents the mean solids content expected in the NorthMet waste rock. The probability distributions developed from this dataset are intended to represent the average solids ratio for an entire waste rock stockpile or category of pit wall (weighted by geologic unit as described above). Therefore, the probability distributions developed from the drill core data are distributions for the uncertainty in the average solids ratios, rather than the distribution for the population of solids ratios. The uncertainty in the sample average solids ratio is described as a normal distribution for each constituent according to the Central Limit Theorem.

For constituents with “Microprobe” identified as the source data, the solids ratios identified from analysis of individual mineral grains in the humidity cell tests have been used to develop distributions. As discussed above for the humidity cell release rates, the complete range of solids ratios observed in the microprobe testing (irrespective of sample sulfur content or category) has been conservatively assumed to represent the possible average release rate ratio from an entire waste rock stockpile or category of pit wall, with no weighting or relationship to sulfur content. The distributions developed from the microprobe data are applied identically to all applicable rock categories (i.e., the Fe/S distribution in pyrrhotite is the same for the Duluth Complex Category 1, 2/3, 4, waste rock and ore). The differences in mineral content between the waste rock categories are represented by the differences in the modeled release of the constituent in the denominator (e.g., differences in pyrrhotite content are represented by the modeled SO<sub>4</sub> release rate for each rock category).

The simulated release rate for each constituent is calculated by multiplying the randomly-selected solids ratio by the randomly-selected release rate of the constituent in the denominator (ex. Cu release rate = Cu/S ratio x SO<sub>4</sub> release rate in terms of S). Release rates under acidic conditions are modeled using the acidity factor to increase the SO<sub>4</sub> release rate (and correspondingly increase the ratioed constituent release rates) as discussed in Section 8.2.5.

### 8.1.2.3.1 Nickel Release

Nickel release rates are calculated in a similar manner to the other constituents defined from solid ratios, with several adjustments to reflect the behavior of nickel in the NorthMet humidity cells and drill core test work. Nickel release in the humidity cells is complicated by storage and release caused by concentration caps and changing pH conditions, resulting in low apparent initial release followed by very high apparent release. The proposed method has been developed in consultation with the Co-lead Agencies as a better estimate of the true underlying nickel release prior to the application of concentration caps.

The nickel to sulfur ratio from the Duluth Complex Category 4 aqua regia (drill core) data is used to conservatively represent the combined influence of all sulfide minerals. This method is preferred over mineral-specific methods previously proposed because it does not require an estimate of the relative content of various minerals (i.e., the relative occurrence of pyrrhotite and pentlandite). The nickel content of the Duluth Complex Category 4 rock is understood to be almost entirely from sulfide minerals, while lower-sulfur rock categories contain more nickel in olivine. The nickel to magnesium ratio from the microprobe data is used to represent the influence of olivine. These ratios are applied identically to all Duluth Complex rock categories, with the only distinction that the ore nickel to sulfur ratio is used for modeling ore rather than the Category 4 ratio.

For nickel (and other constituents with microprobe data for specific minerals used to develop metal ratios), the ratio is multiplied by the total release rate of the constituent in the denominator (i.e., not specific to the minerals identified for the microprobe data). Equation 8-8 below shows an example calculation for nickel release for the Category 1 waste rock, which is a function of: (1) the nickel to sulfur ratio in the Category 4 Duluth Complex aqua regia data; (2) the mass ratio of sulfur to sulfate; (3) the sulfate release rate for Category 1 waste rock, developed from humidity cell data; (4) the nickel to magnesium ratio in the olivine microprobe data; and (5) the magnesium release rate for Category 1 waste rock, developed from humidity cell data. Of these five inputs to the equation, only the mass ratio of sulfur to sulfate is a deterministic value; the remaining inputs are randomly generated using the methods described above.

$$Ni_{Cat1} \left( \frac{mg}{kg \cdot week} \right) = \left[ \frac{Ni}{S} \right]_{Cat4} \cdot \left[ \frac{S}{SO_4} \right] \cdot SO_4 \left( \frac{mg}{kg \cdot week} \right)_{Cat1} + \left[ \frac{Ni}{Mg} \right]_{Ol} \cdot Mg \left( \frac{mg}{kg \cdot week} \right)_{Cat1} \quad 8-8$$

Date: February 13, 2015	NorthMet Project Waste Characterization Data Package
Version: 12	Page 66

## 8.2 Lab to Field Scale-Up

### 8.2.1 Background

As outlined in the initial waste rock modeling report (Reference (3) Section 8.2), a composite scale-up factor was used in the 2008 deterministic calculations of solute release from stockpiled waste rock. The scale-up factor is applied to the nonacidic laboratory release rates (from the humidity cell tests) in order to calculate release rates from full scale waste rock disposal facilities. The bulk scale-up factor ( $S_B$ ) is dependent on four sub-factors that represent the effects of differences between laboratory and field conditions with respect to the water contact ( $k_c$ ), particle size ( $k_s$ ), temperature ( $k_t$ ), and pH ( $k_{pH}$ ).

$$S_B = k_t * k_s * k_c * k_{pH} \quad \mathbf{8-9}$$

This approach is similar to that developed in a published research study for mining wastes in Sweden (Reference (18)). The only difference is the method used to determine the value of the sub-factor to account for differences in pH between laboratory and field conditions (empirical vs. theoretical). Note that the modeled laboratory release rates described in Section 8.1 are for nonacidic conditions; the pH correction factor therefore represents the potential increase in constituent release rates as pH becomes acidic.

The deterministic water quality modeling used different composite scale-up factors for the various types of NorthMet waste rock:

- 1) Category 1 waste rock: the scale-up factor was assumed to be dependent on all sub-factors except  $k_{pH}$ , because Category 1 waste rock in the field is not expected experience pH lower than that observed in the laboratory (Section 8.3.1).
- 2) Category 2/3/4 waste rock and ore (Duluth Complex):
  - a. The nonacidic scale-up factor was assumed to be dependent only on the particle size and water contact sub-factors. This is similar to the Category 1 waste rock but without  $k_T$ . It was conservatively assumed that the reactions within the more reactive (potentially acid generating) waste rock stockpiles will heat up the core of the full scale stockpiles so that there will be negligible temperature difference between full scale and lab conditions, even before the stockpiles have become fully acidic.
  - b. The acidic scale-up factor was assumed to be dependent on all sub-factors except  $k_T$ .
- 3) Category 4 Virginia Formation waste rock: the scale-up factor was assumed to be only dependent on the particle size and water contact sub-factors, because this rock is assumed to be immediately acidic and the humidity cell data used are for acidic conditions.

These bulk scale factors and their values in the deterministic modeling are summarized in Table 8-2.



The same assumptions used in the deterministic modeling for which sub-factors apply to which rock type and condition (temperature, particle size, etc.) are also used in the probabilistic modeling. The difference between the scale factors developed for deterministic and probabilistic modeling is that the sub-factors are modeled as a range of values with an associated probability function. The method for simulating the value of each sub-factor is discussed in detail in the following sections.

**Table 8-2 Deterministic Scale-Up Factor Assumptions**

Rock Type	Condition	Sub-Factors	Deterministic Value <sup>(1)</sup>
Category 1	Nonacidic (all)	$k_t, k_s, k_c$	0.03
Category 2/3/4/ore (Duluth Complex)	Nonacidic	$k_s, k_c$	0.10
	Acidic	$k_s, k_c, k_{pH}$	1.0
Category 4 (Virginia Formation)	Acidic (all) <sup>(2)</sup>	$k_s, k_c$	0.10

(1) Value used in 2008 deterministic water quality modeling (Reference (12))

(2) The acidity factor is not used for modeling Virginia Formation rock because the humidity cells are acidic (no scaling for pH needed)

The proposed methodology for probabilistically modeling the components of the scale-up factor can be applied to all of the waste rock on the Mine Site, with appropriate adjustments to reflect the assumed differences in temperature and pH conditions in the different stockpiles (pH is not explicitly modeled except as discussed in Section 8.3.1). Accounting for the four contributing sub-factors individually (rather than as a single “bulk” scale-up factor) allows the probabilistic models to track the fate of oxidized solutes that are not contacted by water but may be available for future leaching. This is especially important for the waste rock in the temporary stockpiles which is backfilled in the East Pit in the later years of mine operations and flooded with water, mobilizing any remaining oxidized solutes. Regardless of the method to be used for scaling laboratory rates to the field scale, an assumed water contact factor is necessary in order to partition mass that is available for dissolution from that which remains at the source until flooding.

The steps in modeling constituent release from waste rock are as follows:

- 1) Generate random nonacidic laboratory release rates (Section 8.1)
- 2) Generate random scale-up correction factors for water contact, particle size, temperature, and acidity (Section 8.2)
- 3) Calculate field release rates by multiplying nonacidic laboratory release rates by the particle size correction and temperature and acidity corrections (if applicable).
- 4) Partition the released mass between contact (flushed by runoff) and non-contact mass by multiplying by the contact correction.

- a. Contact mass is flushed by runoff and used to estimate drainage water quality.
- b. Non-contact mass remains with the waste rock and is flushed into water if the rock is submerged (i.e., in East Pit backfilling).

### 8.2.2 Water Contact Factor

In the deterministic water quality modeling the contact factor was assumed to be equal to 0.5. This means that half of the rock was assumed to be contacted by water as water percolates through the stockpile, compared to 100% of the rock in the laboratory tests. The percolating water was assumed to contact 50% of the waste rock in the stockpile and collects 50% of the generated solutes, subject to concentration caps (Section 8.3). Theoretically, the contact factor can range from 0 to 1. However, the probability of water contacting 0% or 100% of the waste rock is zero. Therefore, a triangular distribution is proposed for the contact factor, ranging from 0.1 to 0.9 with a mean of 0.5. Figure 8-8 shows the assumed water contact factor probability distribution.

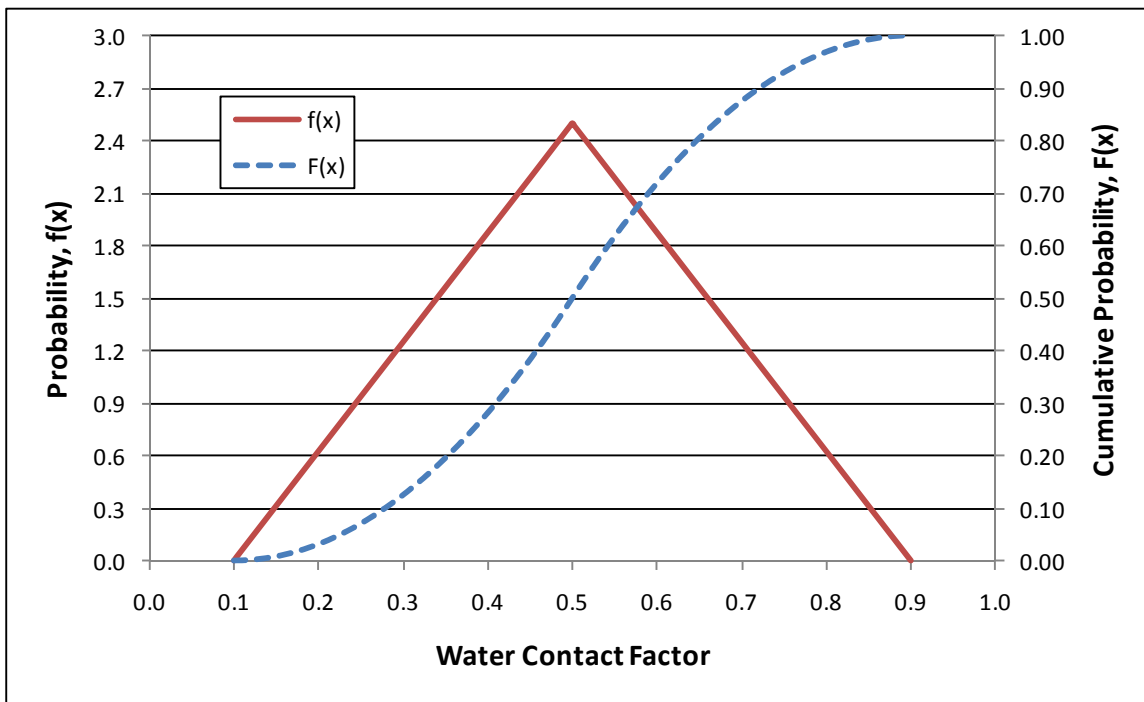

Figure 8-8 Distribution for the Water Contact Factor

### 8.2.3 Particle Size Factor

In the deterministic water quality modeling the particle size factor was assumed to be equal to 0.2, meaning that one ton of field-scale waste rock has 20% of the surface area of one ton of humidity cell rock. Theoretically, the particle size factor can range from 0 to infinity.

Date: February 13, 2015	NorthMet Project Waste Characterization Data Package
Version: 12	Page 69

Particle size distribution data are available for Duluth Complex waste rock from the AMAX test piles (Table 24 of Reference (19)). This material was extracted by underground mining, and therefore is expected to contain more fine material than the open pit mining proposed for the Project due to differences in blasting techniques. This leads to a higher surface area to mass ratio, which is conservative from the standpoint of determining a particle size factor. Assuming that the rock breaks into cubes on average, the AMAX samples are calculated to have surface area to mass ratios ranging from 1.0 to 2.4 [m<sup>2</sup>/kg], with an average of 1.7 [m<sup>2</sup>/kg].

An example calculation of the surface area to mass ratio based on the median AMAX sample is shown in Table 8-3 and outlined in Equations 8-10 to 8-15. From Table 8-3 it is clear that while less than 20% of the sample by mass is finer than gravel (passing the 6.4 mm sieve), the fine material (especially the finest silt- and clay-sized particles) contains virtually all of the particle surface area associated with the sample.

$$\text{Side width}[mm] = \frac{\text{Sieve size}[mm] + \text{Sieve opening}_{\text{larger}}[mm]}{2} \quad \mathbf{8-10}$$

$$\text{Surface area}[m^2] = 6 \cdot \text{Side width}^2[m](\text{assume cubes}) \quad \mathbf{8-11}$$

$$\text{Volume}[m^3] = \text{Side width}^3[m](\text{assume cubes}) \quad \mathbf{8-12}$$

$$\text{Mass}[kg] = \text{Volume}[m^3] \cdot 2.93(\text{assume spec. grav.}) \cdot 1000 \left[ \frac{kg}{m^3} \right] \quad \mathbf{8-13}$$

$$\text{Particles Retained} \left[ \frac{1}{100g} \right] = \frac{\text{Mass}[g]}{\text{Mass Retained} \left[ \frac{g}{100g} \right]} \quad \mathbf{8-14}$$

$$\text{Total Retained Surface Area} \left[ \frac{m^2}{100g} \right] = \text{Surface area}[m^2] \cdot \text{Particles Retained} \left[ \frac{1}{100g} \right] \quad \mathbf{8-15}$$

**Table 8-3 Surface Area to Mass Ratio Calculation Example**

Sieve Size [mm]	Average Retained Particle Dimensions				Calculations for AMAX 0.06%S Sample			
	Side Width [mm]	Surface Area [m <sup>2</sup> ]	Volume [m <sup>3</sup> ]	Mass [kg]	Mass Passing [g/100g]	Mass Retained [g/100g]	Particles Retained [1/100g]	Total Retained Surface Area [m <sup>2</sup> /100g]
305	3.1E+02	5.6E-01	2.8E-02	8.3E+01	100	0	0	0
152	2.3E+02	3.1E-01	1.2E-02	3.5E+01	96.6	3.4	0	0.0000
76.2	1.1E+02	7.8E-02	1.5E-03	4.4E+00	80.2	16.4	0	0.0003
38.1	5.7E+01	2.0E-02	1.9E-04	5.5E-01	51.2	29	0.1	0.0010
19.1	2.9E+01	4.9E-03	2.3E-05	6.9E-02	32.3	18.9	0.3	0.0014
12.7	1.6E+01	1.5E-03	4.0E-06	1.2E-02	20.3	12	1.0	0.0015
6.4	9.6E+00	5.5E-04	8.7E-07	2.6E-03	18.7	1.6	0.6	0.0003
2	4.2E+00	1.1E-04	7.4E-08	2.2E-04	11	7.7	35	0.0038
0.5	1.3E+00	9.4E-06	2.0E-09	5.7E-06	6	5	874	0.0082
0.177	3.4E-01	6.9E-07	3.9E-11	1.1E-07	3.3	2.7	23759	0.0163
0.149	1.6E-01	1.6E-07	4.3E-12	1.3E-08	2.9	0.4	31523	0.0050
0.105	1.3E-01	9.7E-08	2.0E-12	6.0E-09	2.5	0.4	66647	0.0064
0.074	9.0E-02	4.8E-08	7.2E-13	2.1E-09	1.9	0.6	285637	0.0137
0.053	6.4E-02	2.4E-08	2.6E-13	7.5E-10	1.4	0.5	666471	0.0161
finer	2.7E-02	4.2E-09	1.9E-14	5.5E-11	0	1.4	25675730	0.1082
Cumulative Retained Surface Area [m <sup>2</sup> /100g]								0.182
<b>Cumulative Retained Surface Area [m<sup>2</sup>/kg]</b>								<b>1.82</b>

According to a memo from Stephen Day, SRK (Reference (20)), a similar calculation for the Project laboratory data indicate that the material in the humidity cells has a surface area to mass ratio generally between 5.7 and 16 [m<sup>2</sup>/kg], with an median of 9.4 [m<sup>2</sup>/kg]. Using the average value from the AMAX piles and the distribution of humidity cell values, the field-scale waste rock is conservatively estimated to contain between 11% and 30% of the surface area per unit mass of the humidity cell rock (90% confidence interval). The particle size factor is represented by the fitted triangular distribution shown in Figure 8-9.

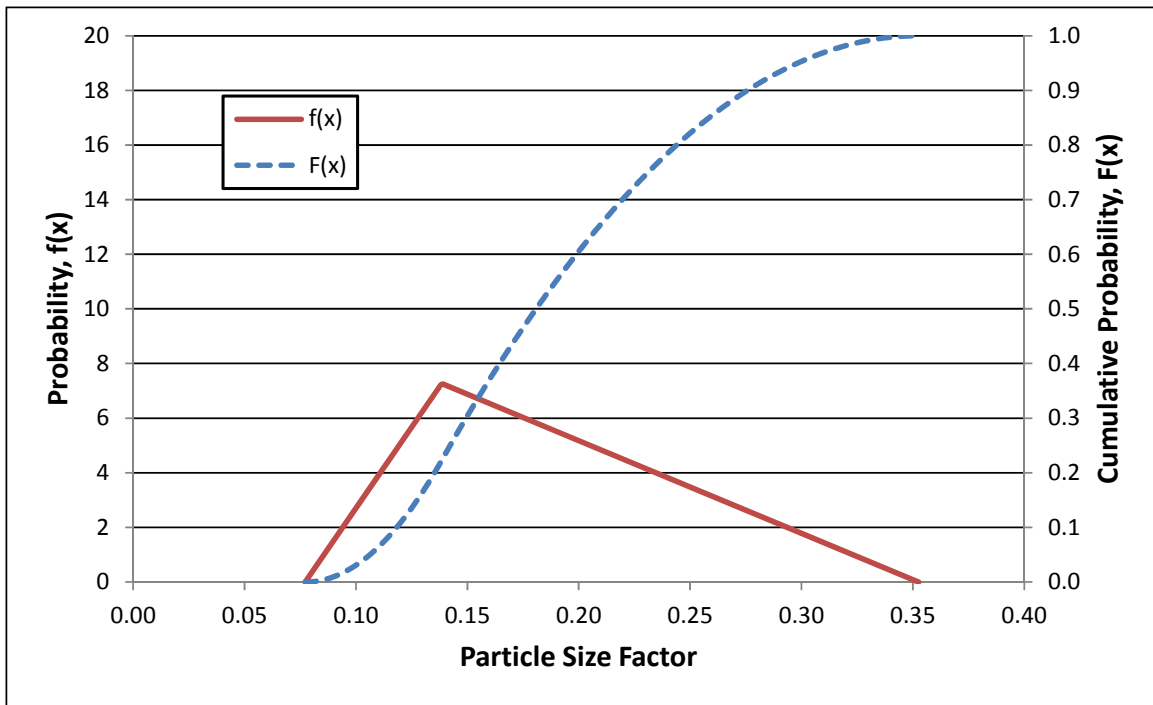

Figure 8-9 Distribution for the Particle Size Factor

### 8.2.4 Temperature Factor

The expected temperature factor can be calculated based on site temperatures, laboratory temperatures, the activation energy for the waste rock and the Arrhenius equation, shown in Equation 8-16.

$$k = Ae^{-E_a/RT} \quad 8-16$$

In the Arrhenius equation,  $k$  is the rate at which a given reaction is taking place.  $A$  is a constant multiplier but is not important here because it will drop out in the following analysis.  $E_a$  is the activation energy [kJ/mol],  $R$  is the universal gas constant of 0.008314 [kJ/mol/K] and  $T$  is the temperature [°Kelvin]. The temperature factor is calculated by dividing the reaction rate on site by the reaction rate in the lab.

$$k_T = \frac{k_{Field}}{k_{Lab}} = \frac{e^{-E_a/RT_{Field}}}{e^{-E_a/RT_{Lab}}} = e^{\frac{E_a}{R} \left[ \frac{1}{T_{Lab}} - \frac{1}{T_{Field}} \right]} \quad 8-17$$

Because the laboratory temperature ( $T_{Lab} = 20^\circ\text{C}$ ) and universal gas constant  $R$  are known, the distribution for the temperature factor is dependent on the distributions for the site temperature  $T_{Field}$  and the activation energy  $E_a$ . By assuming that the average site temperature in the Category 1 Waste Rock Stockpile is equal to the average temperature in any given year, a normal distribution for  $T_{Field}$  can be developed from daily temperature data

from 1981-2000 at locations within 10 miles of the Mine Site (National Weather Service data). Figure 8-10 shows the annual average temperature PDF and CDF.

For the activation energy, the literature-reported range of activation energy for pyrrhotite is between 47 and 63 kJ/mol (Reference (21)). Figure 8-11 shows the PDF and CDF for this range of activation energies.

At the mean site temperature (2.004°C) and the mean activation energy (55 kJ/mol) from the distributions shown in Figure 8-10 and Figure 8-11, the resulting temperature factor  $k_T$  equals 0.228. This compares with a temperature factor of 0.3 used in the deterministic modeling, which was calculated using a temperature of 3°C and assumed activation energy of 47 kJ/mol.

A 5000-run Monte Carlo analysis was performed to assess the combined effects of uncertainty in mean site temperature and activation energy, using the input distributions shown in Figure 8-10 and Figure 8-11. The resulting distribution for  $k_T$  from the input distributions is shown in Figure 8-12.

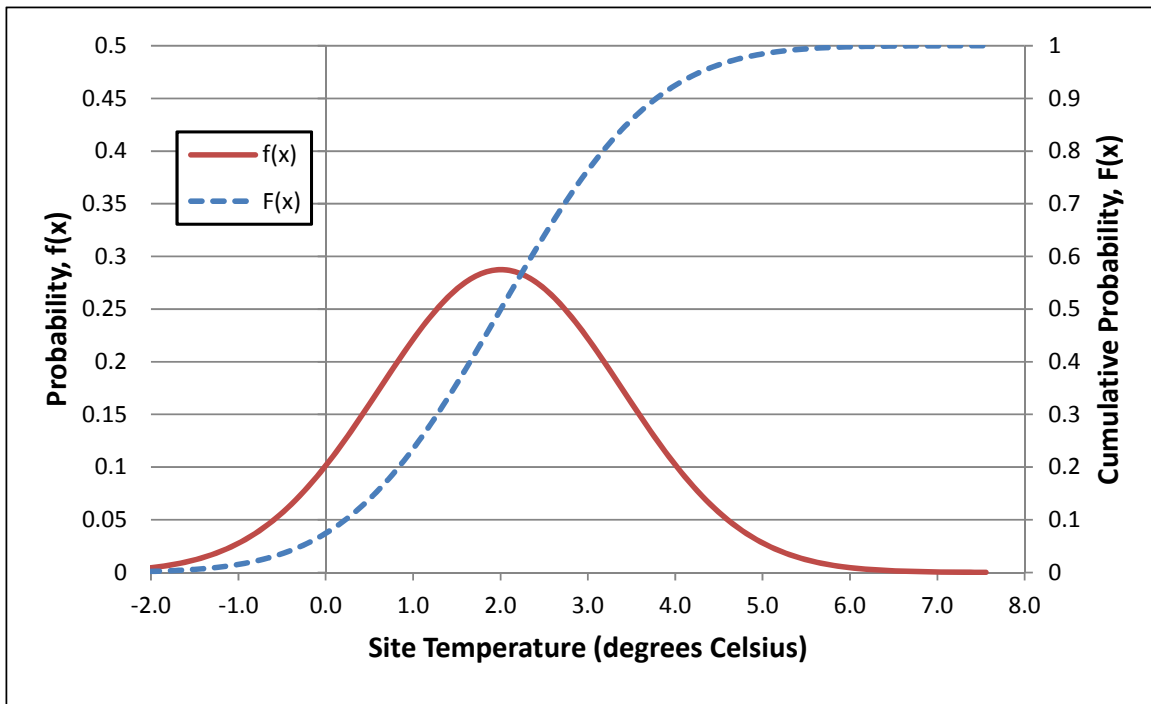

Figure 8-10 Distribution for the Site Temperature

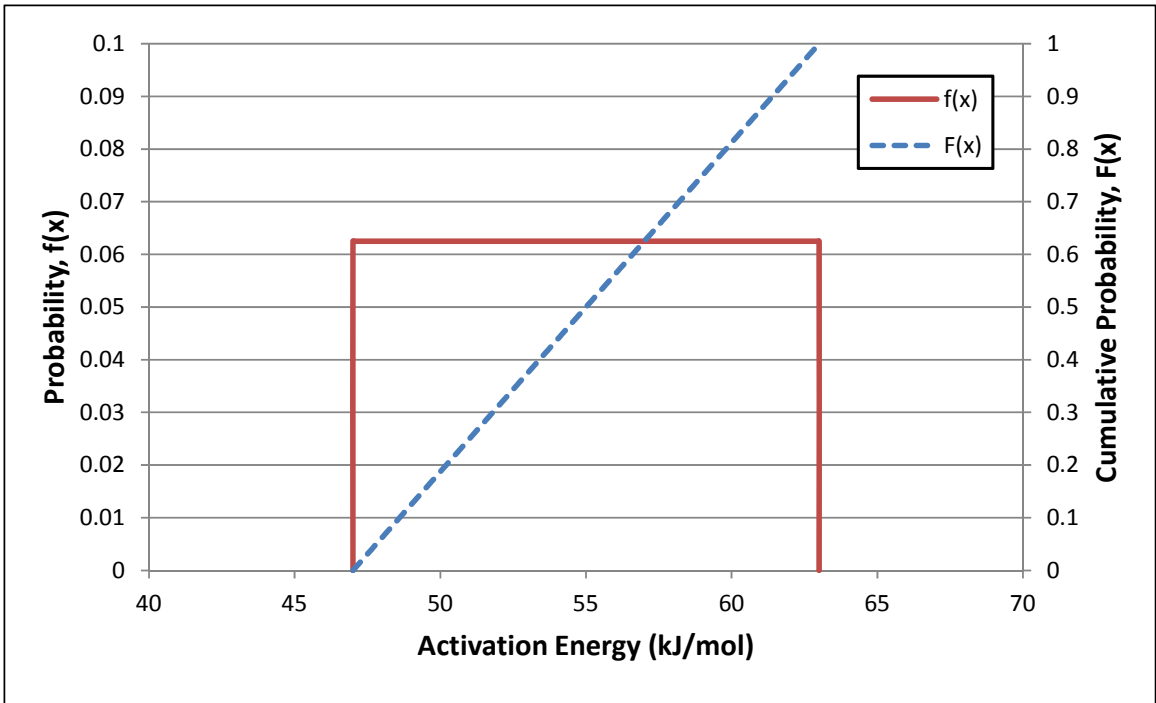

Figure 8-11 Distribution for the Activation Energy

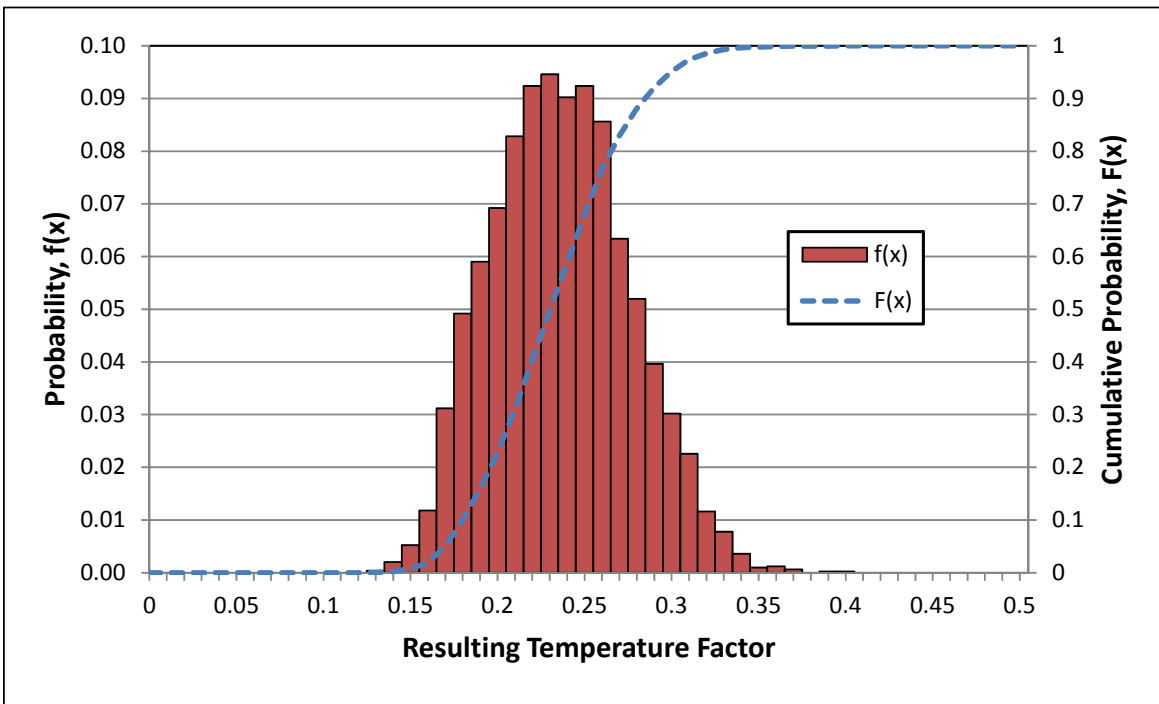

Figure 8-12 Simulated Temperature Factor Distribution

Date: February 13, 2015	NorthMet Project Waste Characterization Data Package
Version: 12	Page 74

### 8.2.5 Acidity Factor

As discussed in Section 8.2.1, an additional scaling factor is necessary to represent the change from nonacidic to acidic conditions for Duluth Complex Category 2/3 and 4 waste rock and ore because the majority of the data from the humidity cell tests represent nonacidic conditions. Category 1 waste rock is not expected to experience acidic conditions under any circumstance. For Virginia Formation waste rock, acidic conditions are represented in the humidity cells and are assumed to begin immediately upon exposure of the rock to the atmosphere. No additional correction for acidic conditions is necessary for modeling the behavior of Virginia Formation waste rock.

The effects of the onset of acidic conditions in the humidity cell tests include an increase in the rate of sulfide oxidation (expressed by the acidity factor  $k_{pH}$ ) and a change in the concentration caps for all constituents. Concentration caps for nonacidic and acidic conditions will be discussed separately in Section 8.3.

The method for calculating nonacidic constituent release rates for Duluth Complex Category 2/3 and 4 waste rock and ore described in Section 8.1 (and outlined in Large Table 2) relies primarily on a determination of the rate of sulfide oxidation as expressed in sulfate release rates. Nonacidic release rates of most other constituents are scaled to sulfate release rates. An increase in sulfate release from the onset of acidic conditions, therefore, will cause increases in the calculated release rates for most other constituents.

As shown in Table 8-2, the acidity factor has only been applied to the Duluth Complex Category 2/3 and 4 waste rock and ore once acidic conditions occur. The time from initial exposure to the atmosphere to the onset of acidic conditions is a function of the relative weathering rates of various minerals and the capacity of the alkalinity released by the silicate minerals in the waste rock to buffer the acidity released by the sulfide minerals. The lag time until acidic conditions become prevalent is indicated by laboratory kinetic testing data.

As discussed in Attachment A, data from the long-term MDNR tests on Duluth Complex rock provide information on the length of time from initiation of the tests until sulfate release increases (indicating increased oxidation rates and acidic conditions) and the magnitude of the increase over nonacidic sulfate release rates. Table 3 of Attachment A for a list of the specific MDNR reactors used in this analysis. These data were used to develop probability distributions for the time to onset of acidic conditions (Figure 8-13) and the ratio of acidic to nonacidic sulfate release (acidity factor  $k_{pH}$ ) as discussed below. This method allows for the simulation of effective acidic release rates for the majority of constituents.

Because the material in the long-term MDNR reactors is, by design, significantly finer than that in the NorthMet humidity cells, it has been suggested that the sulfate release under acidic conditions in the MDNR reactors may be different than what is expected for the NorthMet humidity cells. The finer-grained material has a much higher ratio of exposed surface area to the total mass of sulfide minerals which could potentially result in more-rapid





Date: February 13, 2015	NorthMet Project Waste Characterization Data Package
Version: 12	Page 75

consumption of reactive minerals under acidic conditions. This effect could cause a larger increase in sulfate release rates (relative to nonacidic conditions) and a faster depletion and decay in sulfate release rates over time. The application of this analysis to depletion is discussed in Section 9.4.

As discussed in Attachment A, the empirical acidity factor in the MDNR reactors ranges from 4 to more than 32, with a median value of 9.0. For the NorthMet humidity cells that have reached acidic conditions, the acidity factor ranges from 1 (no increase) to more than 5 (Figure 3 of Attachment A), with a median value of 2.3. The range of sulfur contents is comparable between the two data sets. The MDNR reactors used in this analysis are identified in Table 3 of Attachment A, the NorthMet humidity cells are identified in Large Table 1.

By combining the two data sets (17 MDNR reactors and 8 NorthMet humidity cells), a distribution for the acidity factor can be established (Figure 8-14). A beta distribution has been fit to the full data set, with a minimum value of 1.0 (the lowest observed value), a median value of 5.5, and a maximum value of 32.4 (the highest observed value). This distribution reflects the wide uncertainty over the true acidity factor for sulfate release rates, but encompasses the full range of available data. In the probabilistic modeling the value generated from this distribution is applied to all Duluth Complex Category 2/3, 4, and ore waste and wall rock throughout each realization. The acidity factor has also been correlated to parameters for modeling long-term decay as discussed in Section 9.4.

Note that the distributions shown for the time to onset of acidity in Figure 8-13 were developed from laboratory data and reflect laboratory temperatures. The onset of acidic conditions is expected to take longer for waste rock and wall rock at field temperatures. This is reflected in the model by dividing the time to onset of acidity by the simulated temperature factor for Duluth Complex Category 2/3,4 and ore wall rock (Section 9.4). Waste rock in the Category 2/3 and Category 4 Waste Rock Stockpiles and the Ore Surge Pile is assumed to react at laboratory temperatures, so no correction is needed.

For those constituents for which the nonacidic Duluth Complex Category 2/3 and 4 waste rock and ore release rates are based on humidity cell release ratios (ex. calcium) or are not scaled to sulfate (ex. boron), the appropriate data from the humidity cell tests under acidic conditions (i.e., Condition 3 in Large Table 1) were used to develop probability distributions. Simulation of the release of these constituents proceeds as discussed in Section 8.1.

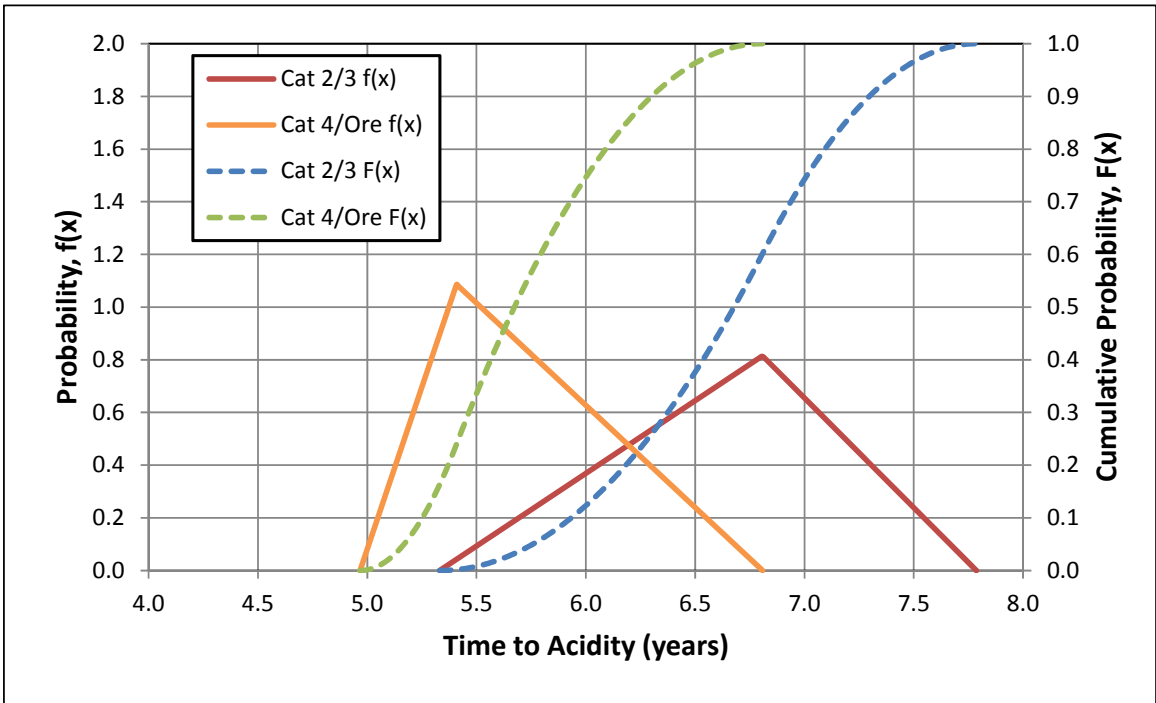

Figure 8-13 Distributions for the Time to Onset of Acidity

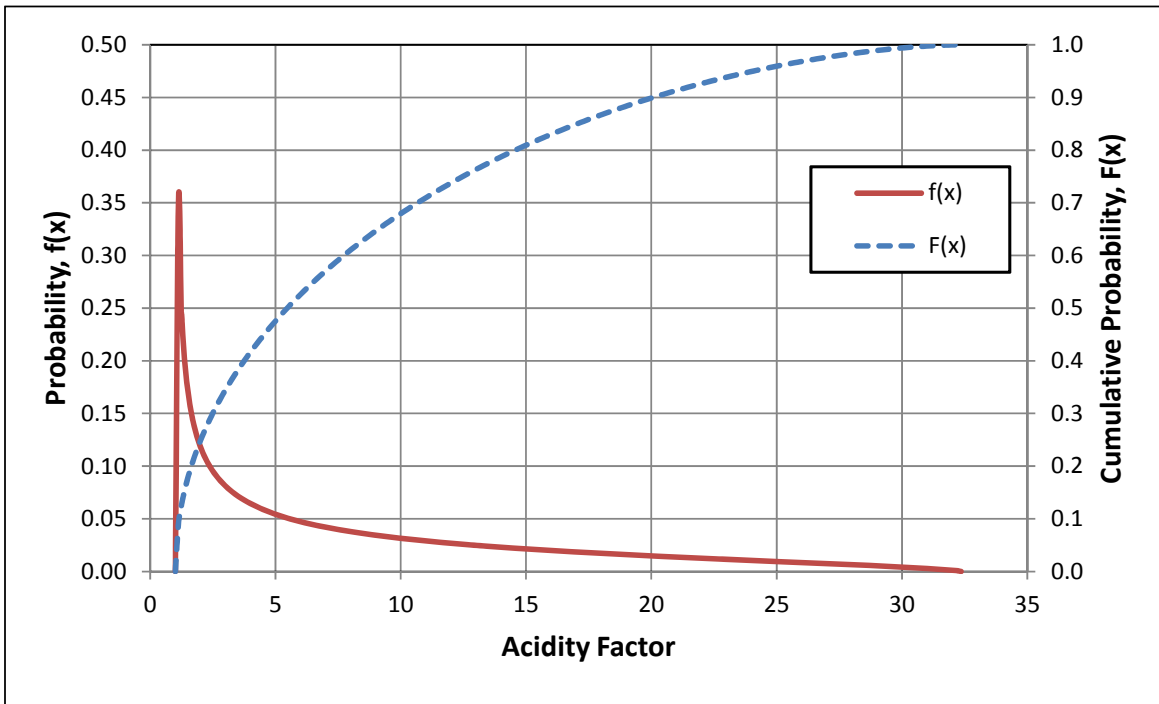

Figure 8-14 Distribution for the Acidity Factor

### 8.2.6 Composite “Bulk” Scale-Up Factor

Table 8-4 is a summary of the probability distributions presented in the above sections.

**Table 8-4 Input Variables for Scale-Up Factor Modeling**

Variable	Description	Units	Dist. Type	Mean or Mode	Std. Dev.	Max	Min
$k_c$	Contact Factor	--	Triang.	0.5	--	0.9	0.1
$k_s$	Size Factor	--	Triang.	0.138	--	0.077	0.353
$T_{Lab}$	Lab Temp	°C	Const.	20	--	--	--
$T_{Field}$	Site Temp	°C	Normal	2.004	1.388	--	--
$E_a$	Activation Energy	kJ/mol	Uniform	--	--	63	47
$R$	Gas Constant	kJ/mol/K	Const.	$8.314 \times 10^{-3}$	--	--	--
$k_{pH}$	Acidity Factor	--	Beta	8.2	7.48	32.4	1.01

Using the GoldSim simulation software a 5000-run Monte Carlo analysis was performed to calculate a composite “bulk” scale-up factor distribution using the input distributions detailed in Table 8-4. The sub-factors were combined as described in Table 8-2 to develop three separate bulk scale-up distributions: (1) water contact, particle size, and temperature effects; (2) water contact and particle size effects; (3) water contact, particle size, and acidity effects. The resulting distributions are shown in Figure 8-15 and Figure 8-16 and summarized in Table 8-5.

**Table 8-5 Results from Monte Carlo Analysis of Bulk Scale-Up Factors**

Cumulative Probability	$SB_1$ $k_c * k_s * k_T$	$SB_2$ $k_c * k_s$	$SB_3$ $k_c * k_s * k_{pH}$
0.05	0.0076	0.035	0.070
0.10	0.0096	0.044	0.093
0.25	0.014	0.062	0.17
0.50	0.020	0.088	0.45
0.75	0.028	0.12	1.1
0.90	0.037	0.16	1.9
0.95	0.043	0.18	2.5
Average	0.022	0.095	0.77

Note that these bulk scale-up factors represent the apparent “bulk” scaling for constituent release in stockpile drainage. Through the application of the contact factor additional constituent mass is modeled as being released and stored with the waste rock until inundation.

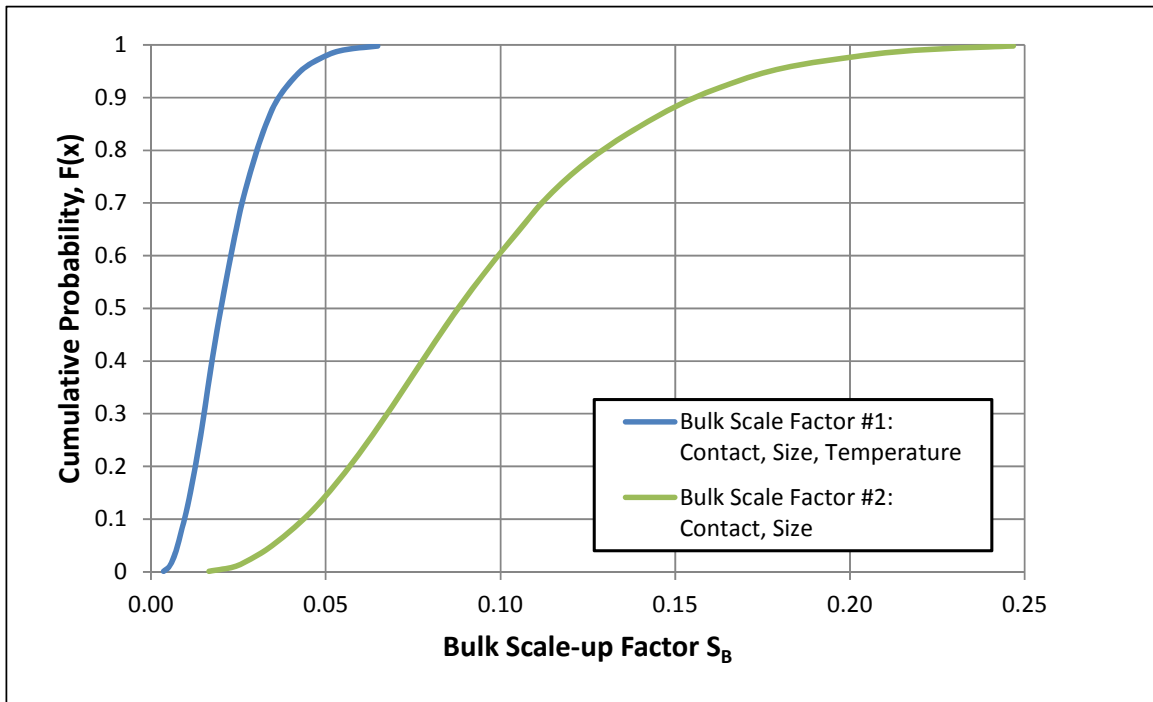
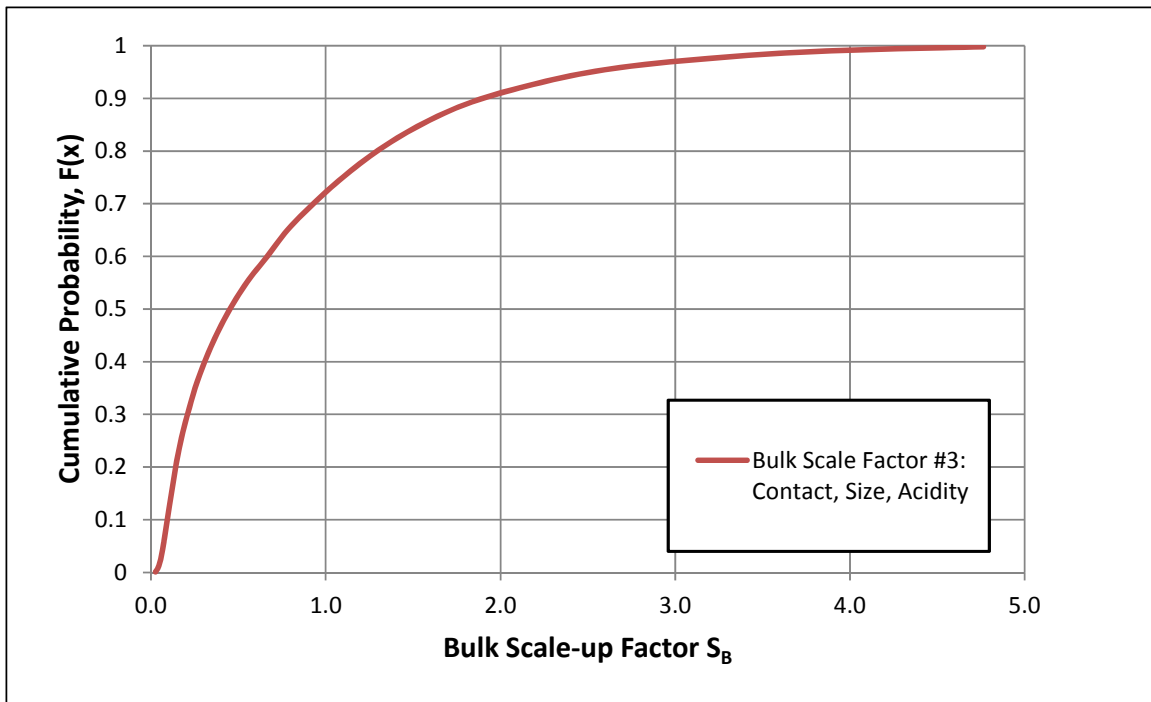

Figure 8-15 Bulk Scale Factor Distributions (nonacidic)



**Figure 8-16 Bulk Scale Factor Distribution (acidic)**

### 8.2.7 Scale-Up Model Verification

The proposed scale-up approach was tested for acidic conditions by modeling the AMAX test piles and comparing the modeled and observed sulfate release rates (Reference (22)). The model inputs described in Sections 8.2.2 through 8.2.5 were used as described (including the acidity factor), with several adjustments to reflect the characteristics of the AMAX piles:

- sulfate release rates from humidity cell tests on AMAX rock (Reference (19)) were analyzed with the linear regression method described in Section 8.1.1.2
- the water contact factor distribution was shifted higher to reflect greater water contact in the small test piles
- the particle size factor distribution was developed from documented particle size distribution data for the AMAX field and laboratory samples (References (19) and (23))
- the temperature factor was used (correcting for lower field temperatures) even though the piles were modeled as being acidic to reflect the small heat-retention capacity of the small piles

The lab to field scale-up approach presented here provided good estimates of the median annual observed sulfate release without any calibration. In all cases, the high end of the distribution of modeled sulfate release was well above the highest single-year observed sulfate release. The results of this test model for the four acidic AMAX piles are shown in Table 8-6.

**Table 8-6 AMAX Test Model Results for Sulfate Release**

Pile	Avg S [%]	Acidic Period	Observed Sulfate Release [mol/yr] <sup>(1)</sup>			Modeled Sulfate Release [mol/yr] <sup>(2)</sup>		
			Min.	Med.	Max.	P5	Med.	P95
FL3	0.64	1984-1989	1100	1200	1700	200	1200	4300
FL4	0.64	1984-1989	740	1300	1500	240	1400	6600
FL5	1.41	1978-1993	1200	2500	3900	380	2200	9100
FL6	0.79	1980-1993	1100	1800	4200	430	2300	6500

(1) Source: Reference (19)

(2) Source: Reference (22)

A similar test of this scale-up approach for nonacidic conditions is not possible, because there is no well-characterized field analog for low-sulfur Duluth Complex waste rock (analogous to Category 1 waste rock). All of the AMAX test piles became fully acidic after less than 13 years and have sulfur content that is at least an order of magnitude higher than the average for the Category 1 waste rock. Even during the initial period of nonacidic seepage it is likely that an unknown fraction these test piles experienced local acidic conditions, resulting in elevated sulfate release relative to “true” nonacidic conditions. The other existing locations of field-scale stockpiled Duluth Complex rock, at the former LTVSMC Dunka Mine, were not designed as research stockpiles and have uncertainties in their composition (including sulfur content) and drainage pathways. In addition, there are no directly-comparable humidity cell tests on the Dunka Mine waste rock that allow the development of a lab to field comparison.

The lab to field scale-up method presented here has been developed from theoretical geochemical principles and tested against data from test piles of acidic Duluth Complex rock. This test, along with published work (Reference (18)) corroborates the conceptual model being applied for all of the Project waste rock stockpiles using the appropriate sub-factors as described in Table 8-2. It is the professional opinion of PolyMet and its consultants that this probabilistic method provides a realistic range of the lab to field scale-up ratio for both acidic and nonacidic conditions. The model results in Table 8-6 show that this method



Date: February 13, 2015	NorthMet Project Waste Characterization Data Package
Version: 12	Page 81

produces conservatively high estimates of sulfate release with respect to the maximum observed release at field scale under acidic conditions.

### 8.2.8 MDNR Method for Category 1 Waste Rock Stockpile Scale-Up

MDNR has proposed an alternate method for simulating the lab to field scale-up factor, based on observed sulfate leaching data from stockpiles at the Dunka Mine (Reference (24)). This method is specific to the Category 1 Waste Rock Stockpile and does not replace the composite scale-up factor method described above for the Category 2/3 and Category 4 Waste Rock Stockpiles, the Ore Surge Pile and the wall rock.

The MDNR scale-up method uses laboratory sulfate release rates as a function of sulfur content, developed from MDNR reactor tests on rock from the Dunka Mine blast holes (Reference (23)). The average sulfate release for each MDNR reactor is determined for the first 71 weeks of testing (excluding the initial 5 weeks to remove flushing effects), and duplicate reactors are averaged. The laboratory release rates from the reactor tests are scaled to the equivalent humidity cell release rates by a factor of 0.34 (the finer material in the MDNR reactors releases sulfate about three times faster than the standard ASTM humidity cells). By this method 17 average sulfate release rates as a function of sulfur content [ $\text{mass SO}_4/(\text{mass rock} * \text{time} * \%S)$ ] are determined.

The MDNR scale-up method uses field sulfate release rates as a function of sulfur content, developed from seepage water quality data from Dunka Mine stockpiles. The seeps and time periods used in this analysis are shown in Table 8-7, and represent the entire period of flow and concentration data for each seep (Reference (25)). Annual sulfate release is determined from the concentration and flow data for each seep. By this method 42 annual sulfate release rates as a function of sulfur content [ $\text{mass SO}_4/(\text{mass rock} * \text{time} * \%S)$ ] are determined.

MDNR has calculated a range of “bulk” scale-up factor values as the ratio between annual field sulfate release and the average laboratory sulfate release, using all possible combinations of field and laboratory release rates. The calculated values are shown as the histogram in Figure 8-17, and a beta distribution fit to the observed values is shown by the lines in Figure 8-17. Because this distribution represents the temporal variability in the field data and spatial variability represented by the laboratory data, a value for this distribution is re-generated for each year of the model.

**Table 8-7 MDNR Dunka Stockpile Data used for Scale Factor Analysis**

Seep	Avg S [%]	Duration [years]	Time Period
Seep X	0.24	3	1990 - 1992
Seep 1	0.24	7	1986 - 1992
EM8	0.31	13	1979 - 1991
W4	0.35	12	1980 - 1991
W1D	0.97	7	1986 - 1992

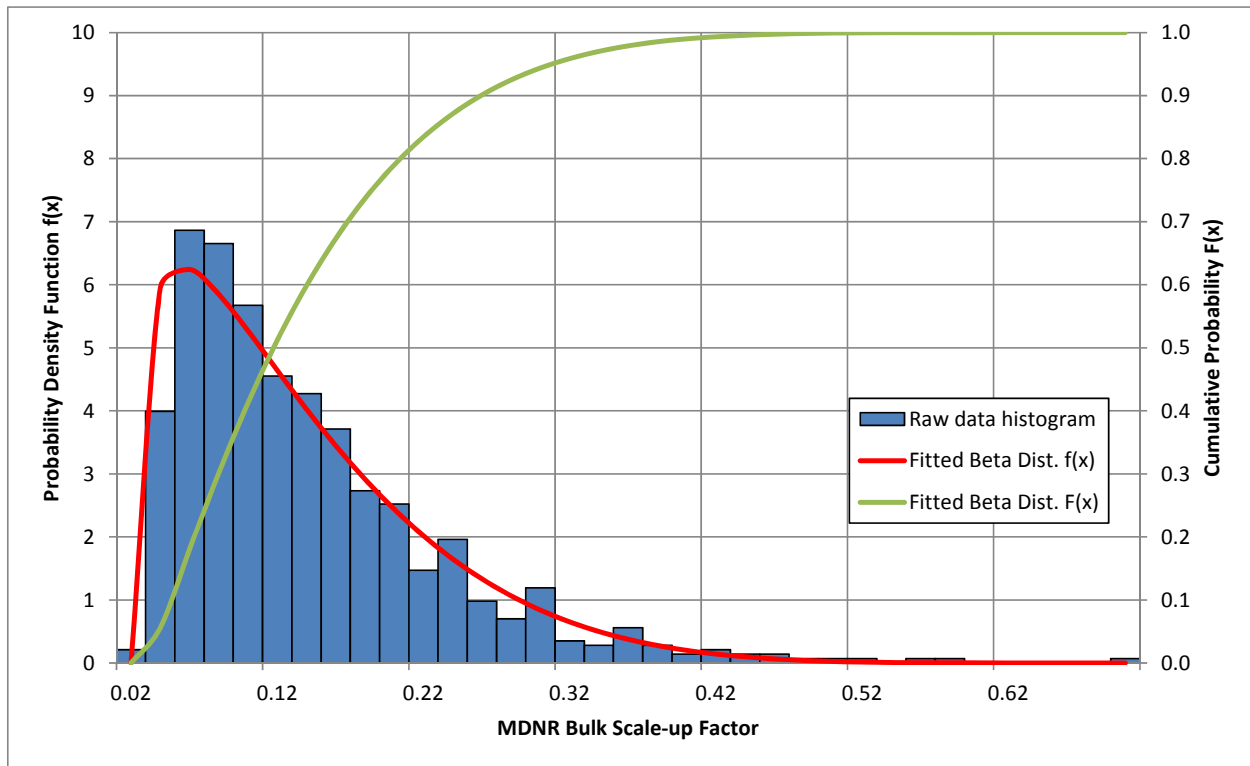

**Figure 8-17 MDNR Bulk Scale-up Factor Distribution**

As directed by the Co-lead Agencies, this distribution for the Category 1 Waste Rock Stockpile lab to field scale-up has been used for initial modeling of potential project impacts. It is the professional opinion of PolyMet and its consultants that this distribution is overly conservative.





Date: February 13, 2015	NorthMet Project Waste Characterization Data Package
Version: 12	Page 83

### 8.3 Concentration Caps

An updated methodology for interpreting the anticipated concentration caps for waste rock is described in Section 4.1.3.1 and Large Table 11, based on the methods presented in Attachment A. Attachment A includes leachate chemistry data from full-scale waste rock stockpiles that have similar characteristics to NorthMet Category 2/3 and Category 4 waste rock and have observed primarily acidic conditions (Whistle and Vangorda mines). These data have been used to complement the MDNR data from the AMAX test piles to develop concentration caps for the waste rock stockpiles.

Concentration caps are used in the water quality modeling to limit concentrations of dissolved metals in effluent from the stockpiles. The term “solubility limits” has been used to describe this modeling input in previous documents; in this and all future documentation the term used will be “concentration caps”. The maximum concentrations of dissolved metals observed under field conditions result from multiple competing geochemical processes such as mineral precipitation and dissolution, sorption, desorption, and solubility of secondary minerals. The concentration cap, therefore, is primarily an empirical method for modeling the combined effect of these complex processes in field-scale waste rock stockpiles. The proposed modeling methods in this section make use of available laboratory and field data as well as thermodynamic modeling.

#### 8.3.1 Category 1 Waste Rock

The probability distributions for the Category 1 waste rock concentration caps are shown in Large Table 12 and Large Figure 23 through Large Figure 27.

Differing methods for developing concentration caps for the Category 1 waste rock have been proposed by PolyMet and MDNR (Reference (26)). Both methods are described below and the differences are identified; as directed by the Co-lead Agencies, only the values for the method approved by the Co-lead Agencies are shown in Large Table 12 for use in initial modeling of potential project impacts. It is the professional opinion of PolyMet and its consultants that the concentration caps approved by the Co-lead Agencies are overly conservative for many constituents. However, engineering controls have been put in place for the Project based on these results to minimize environmental impacts. Adaptive management is also in place to enable adjustments to water treatment or mitigation needs as the Project develops and monitoring data can be obtained and analyzed.

##### 8.3.1.1 Category 1 Waste Rock Stockpile pH

The long-term pH in the Category 1 Waste Rock Stockpile will be determined by the interaction between the oxidation of sulfide minerals (producing acidity), the weathering of silicate minerals (producing alkalinity), and the additional acidity from dissolved carbon dioxide gas. This interaction will result in the precipitation of secondary minerals (calcite, ferrihydrite, gypsum, kaolinite, magnesite, silica) until a stable pH is attained. While the



Date: February 13, 2015	NorthMet Project Waste Characterization Data Package
Version: 12	Page 84

Category 1 waste rock is not expected to become acidic, variations in pH in the circum-neutral range (pH 6-8) can cause significant changes in porewater concentrations for some constituents. The uncertainty in the stockpile pH is therefore an important consideration in assessing the uncertainty in the concentration caps assigned to the Category 1 waste rock.

Geochemical modeling of the Category 1 waste rock using Geochemist's Workbench was performed to estimate the stable pH in the porewater at various sulfur contents. The sulfate release rate was defined as a function of sulfur content according to the relationship developed from NorthMet humidity cell data (Section 8.1.1.2). The release rates for the major cations (Ca, Mg, Na) were defined as the average stable (weeks 174-188) release from the six humidity cells with the lowest sulfur contents. These release rates are assumed to represent silicate weathering in the near absence of sulfide minerals, and were not varied with increasing sulfur content or with CO<sub>2</sub> concentration. The partial pressure of carbon dioxide (which controls the amount of CO<sub>2</sub> dissolution) was defined for two different modeling cases: atmospheric CO<sub>2</sub> (log pCO<sub>2</sub> = -3.4, equivalent to 398 ppm) and enriched CO<sub>2</sub> (log pCO<sub>2</sub> = -2.0, equivalent to 1%). The modeled pH for both cases is shown in Figure 8-18.

The stable pH data from laboratory tests on oxidized Category 1 waste rock (Section 4.1.3.1) are also shown in Figure 8-18. These data closely follow the upper line (log pCO<sub>2</sub> = -3.4) and confirm the modeling assumptions and methodology for stable pH in the Category 1 waste rock porewater under atmospheric CO<sub>2</sub> conditions. There is less variation in the empirical data than in the model results, with the pH for lower- and higher-sulfur samples plotting closer to the mean pH than predicted by the geochemical model.

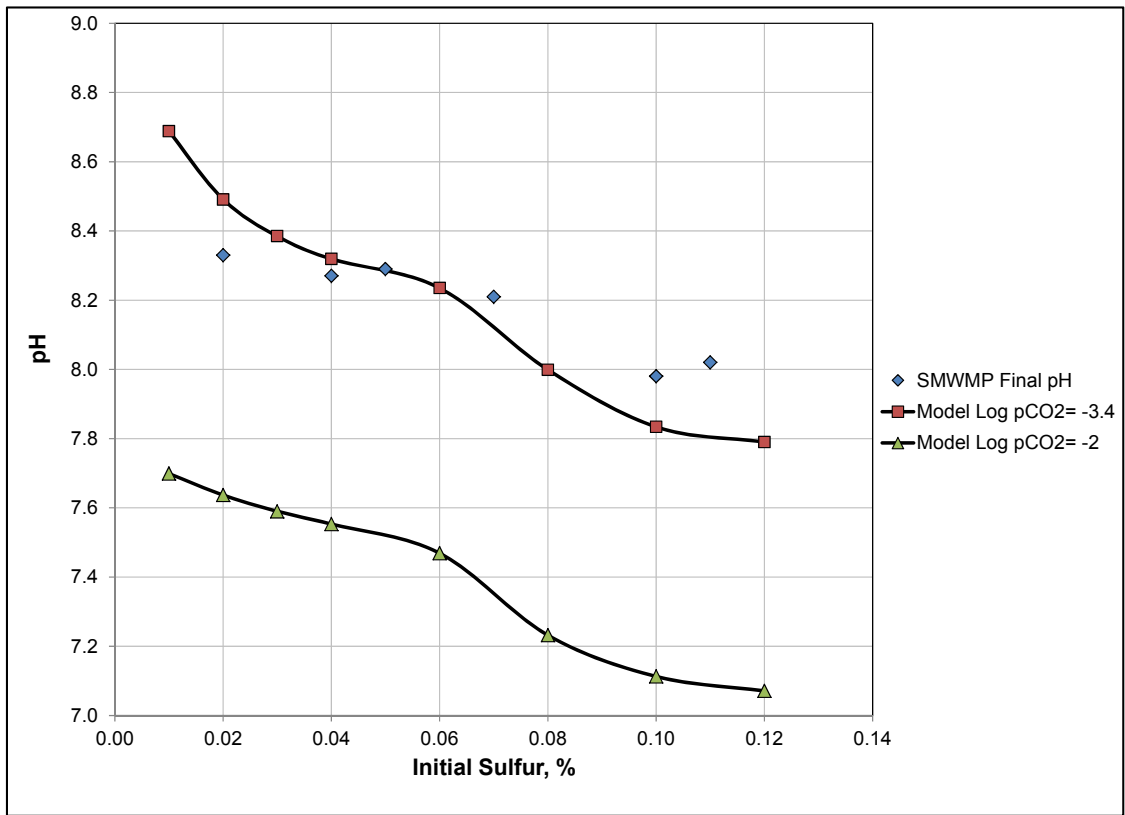

**Figure 8-18 Modeled Category 1 Waste Rock pH**

Enriched CO<sub>2</sub> conditions have been inferred from MDNR geochemical modeling of taconite tailings (which contain carbonate minerals), and are observed in existing waste rock stockpiles for rock that contains carbonate minerals; carbonate minerals provide a source of carbon for CO<sub>2</sub> enrichment. The Duluth Complex Category 1 waste rock, however, is almost devoid of carbonates and will not in itself be a source of elevated CO<sub>2</sub>. Other potential sources of carbon to the Category 1 Waste Rock Stockpile porewater are organic material and the resulting microbial communities present in soil growing layers, which give off CO<sub>2</sub> during respiration. Although the Category 1 Waste Rock Stockpile will not be placed on a constructed liner, the amount of organic material in the stockpile foundations is expected to be minimal due to geotechnical requirements. The vegetated cover that will be placed on the Category 1 Waste Rock Stockpile in closure, however, will have an active growing layer extending around the entire outer shell of the stockpile. Because all infiltration water in closure will pass through this vegetated layer, it is likely that elevated CO<sub>2</sub> levels will exist for some unknown depth below the cover soils. Whether CO<sub>2</sub> enrichment will persist throughout the interior of the stockpile in the absence of carbonate minerals is unknown. Geochemical mechanisms that would tend to reduce CO<sub>2</sub> concentrations (and therefore increase pH) include carbon sequestration in the formation of carbonate mineral precipitates.

To reflect the uncertainty in the long-term behavior of the Category 1 Waste Rock Stockpile porewater, pH is modeled as a probabilistic *input* to the water quality model for the Category 1 Waste Rock Stockpile. It is conservatively assumed that CO<sub>2</sub> enrichment persists to some degree throughout the entire stockpile.

The proposed distribution for the average pH is defined from the range shown in Figure 8-19; a triangular distribution with a minimum value of 7.1, a maximum value of 7.7, and a most likely value of 7.4. This uncertainty reflects the potential for processes that may increase or decrease the mean pH from the modeled value of 7.4, which represents CO<sub>2</sub> enrichment at the mean sulfur content.

The method approved by the Co-lead Agencies for modeling the average stockpile pH is also shown in Figure 8-19 as a uniform distribution between 7.0 and 7.5. It is the professional opinion of PolyMet and its consultants that this range is overly conservative.

In the probabilistic water quality modeling, the randomly-generated pH for each realization is used to determine the concentration caps for some constituents using the methods discussed below.

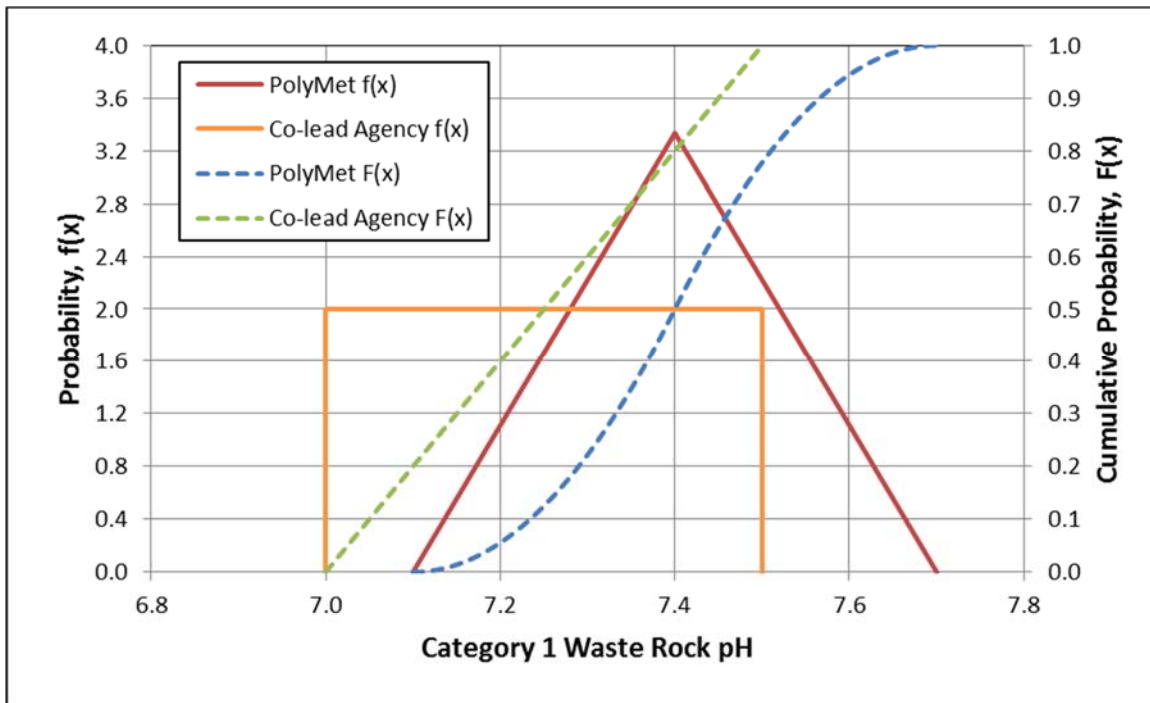

Figure 8-19 Distribution for Category 1 Waste Rock pH

### 8.3.1.2 Concentration Caps from Category 1 SMWMP Study

The concentration cap study (SMWMP) described in Section 4.1.3.1 provides empirical data on appropriate concentration caps for many constituents for the Category 1 waste rock. For



Date: February 13, 2015	NorthMet Project Waste Characterization Data Package
Version: 12	Page 87

constituents that were shown to be constrained in the study probability distributions for the solubility limits have been determined based on the range of concentrations observed for the last cycle of leach testing. Although the stable pH in the concentration cap study was higher than the range shown in Figure 8-19 (stable pH of approximately 8), concentration caps for most constituents are not expected to be sensitive to a possible pH shift from 8 to 7. Those metals that are sensitive to pH in this range are discussed in Section 8.3.1.5.

The Category 1 concentration caps approved by the Co-lead Agencies do not use the results of the SMWMP study because of concerns about the conditions and characteristics of the study. The concentration caps discussed in the remainder of this section are for the PolyMet method only.

The constituents that have concentration caps developed from the SMWMP study include silver, aluminum, alkalinity, arsenic, beryllium, iron, potassium, sodium, lead, antimony, thallium, and vanadium. The range of maximum concentrations is used to define the uncertainty in the concentration caps (uniform distribution); the specific values are shown in Large Table 12. Although selenium was not constrained in the study, the selenium concentration was shown to be directly correlated to the observed sulfate concentration. The selenium concentration cap is defined from the modeled sulfate concentration using a regression relationship from the final leaching cycle in the concentration cap study (Equation 8-18).

Selenium: 
$$Se \left( \frac{mg}{L} \right) = 6.35 \times 10^{-6} \cdot SO_4 \left( \frac{mg}{L} \right) + 0.0020 \quad \mathbf{8-18}$$

None of these constituents are expected to have concentration caps that will significantly increase due to pH changes from the range in the Category1 study to the range modeled in Figure 8-19.

As discussed in Section 4.3.2, the sulfur content of the Category 1 Waste Rock Stockpile will vary locally across the range of sulfur contents used in the solubility limit study, but the expected average sulfur distribution of the stockpile as a whole will be more limited and will tend towards the middle of the range of sulfur contents in the solubility limit study. In developing probability distributions for the solubility limits, however, no attempt has been made to weight the available data by sulfur content or otherwise bias the determined solubility towards the expected average sulfur content conditions in the field. This results in conservatively wide ranges for the modeled solubility limits relative to the likely average field conditions.

### 8.3.1.3 Concentration Caps from Modeled Mineral Solubility

Some of the constituents that were not constrained in the SMWMP study are expected, based on thermodynamic considerations, to be controlled by the solubility of secondary minerals. The limiting equations are shown in Equations 8-19 through 8-23 below (adapted from

Attachment A). The concentration cap equations for these constituents are identical for the PolyMet method and the method approved by the Co-lead Agencies.

For sulfate (gypsum solubility), calcium (gypsum solubility), and magnesium (calcium-magnesium ratio), the concentration cap for each realization in the probabilistic model is calculated based on the release rates of the referenced constituents (converted to molar release rates). A single value for the solubility limit is generated for each model realization. This method results in a major-ion charge balance at the concentration cap.

For barium (barite solubility) and fluoride (fluorite solubility, Reference (27)), the concentration cap for each time step in the probabilistic model is calculated based on the current concentrations of sulfate and calcium, respectively (i.e., the applicable concentration cap for barium is calculated based on the current sulfate concentration).

$$\text{Sulfate: } SO_4 \left( \frac{mg}{L} \right) = 1294 \times \frac{[Mg + .5Na + .5K] \left( \frac{mmol}{kg \cdot week} \right)}{Ca \left( \frac{mmol}{kg \cdot week} \right)} + 1760 \quad 8-19$$

$$\text{Calcium: } Ca \left( \frac{mmol}{L} \right) = \frac{2SO_{4,Cap} \left( \frac{mmol}{L} \right) + Alk_{Cap} \left( \frac{mmol}{L} \right) - K_{Cap} \left( \frac{mmol}{L} \right)}{2 + \frac{[2Mg + Na] \left( \frac{mmol}{kg \cdot week} \right)}{Ca \left( \frac{mmol}{kg \cdot week} \right)}} \quad 8-20$$

$$\text{Magnesium: } Mg \left( \frac{mg}{L} \right) = Ca_{Cap} \left( \frac{mg}{L} \right) \cdot \left[ \frac{Mg}{Ca} \right] \left( \frac{mg}{kg \cdot week} \right) \quad 8-21$$

$$\text{Barium: } \log \left[ Ba \left( \frac{mg}{L} \right) \right] = -0.32 \cdot \log \left[ SO_4 \left( \frac{mg}{L} \right) \right] - 0.87 \quad 8-22$$

$$\text{Fluoride: } F \left( \frac{mol}{L} \right) = \sqrt{\frac{8.91 \times 10^{-11} \left( \frac{mol^3}{kg^3} \right)}{Ca \left( \frac{mol}{L} \right)}} \cdot \left[ \rho_{water} \left( \frac{kg}{L} \right) \right]^{1.5} \quad 8-23$$

None of these constituents are expected to have concentration caps that are sensitive to changes in pH in the range of 7 to 8.

#### 8.3.1.4 Concentration Caps from Analog Site Data

For some of the constituents that were not constrained in the SMWMP study, concentration cap data are available from the analog sites detailed in Attachment A. For both boron and chromium, the available data are from the Whistle Mine site under nonacidic conditions (pH 6.9 to 8.1). These constituents were not detected in the data set; the detection limit is used as the concentration cap. No concentration cap is assumed for chloride.



Date: February 13, 2015	NorthMet Project Waste Characterization Data Package
Version: 12	Page 89

The concentration caps for the method approved by the Co-lead Agencies use data from the Whistle Mine site under nonacidic conditions for several additional constituents: arsenic, lead, and vanadium. These constituents were not detected in the Whistle Mine data set; the detection limit is used as the concentration cap. It is the professional opinion of PolyMet and its consultants that these values are overly conservative.

The concentration caps for the method approved by the Co-lead Agencies use data from samples collected from Dunka Mine Stockpiles for the constituents: silver, beryllium, and thallium. For these constituents, a single sampling event in May 2006 (Reference (28) Appendix C) is used to derive the concentration cap, with the concentration cap being equal to the maximum observed value (or detection limit, where there were no detected values) times a factor of 10, an estimate of the maximum concentration based on differences between Zn and Ni in the May 2006 sample and maximum observed concentration of those constituents in Dunka Mine seepage. For the constituent antimony, the concentration cap is defined as a uniform distribution between the highest concentration observed in uncontaminated tailings HCT and waste rock reactor experiments (lower bound) under the assumption that the highest antimony concentration is not a diluted concentration and an upper limit derived under the assumption that antimony concentrations scale similarly to sulfate concentrations between laboratory and field conditions.

### **8.3.1.5 Concentration Caps Dependent on pH (PolyMet method)**

The modeling of pH-dependent concentration caps differ for the PolyMet method and the method approved by the Co-lead Agencies. The concentration caps discussed in the remainder of this section are for the PolyMet method only.

The constituents with concentration caps that are most likely to be sensitive to changes in the stockpile pH over the expected pH range are cadmium, cobalt, copper, manganese, nickel, and zinc.

Cadmium concentrations in the Project humidity cells are strongly correlated to zinc concentrations (Attachment A); the cadmium to zinc release ratio is used to estimate cadmium release rates (Section 8.1.2.2). This same ratio is used to simulate the concentration cap for cadmium as a function of the zinc concentration cap (below).

Copper and nickel were not constrained in the SMWMP study, and the remaining metals (cobalt, manganese, zinc) were constrained in the SMWMP study at stable pH typically at or above 8.0. Because the concentration caps for these metals are sensitive to pH changes in the range discussed in Section 8.3.1.1, a method has been developed to model the concentration cap as a function of pH. This method is based on the following assumptions:

- the Category 1 SMWMP study results represent likely concentration caps at the measured stable pH for Category 1 waste rock (if concentration caps were indicated)

Date: February 13, 2015	NorthMet Project Waste Characterization Data Package
Version: 12	Page 90

- the highest observed concentrations in the AMAX test piles (0.64%S) represent likely concentration caps at a range of pH values for higher-sulfur waste rock
- the concentration-pH relationship observed in the AMAX data can be understood from thermodynamic first principles, with a slope that is dependent on the valence state of the dominant metal ions
- the same concentration-pH relationship applies to the Category 1 waste rock, but must be shifted to intersect the Category 1 SMWMP data

The relevant AMAX and Category 1 data for the PolyMet concentration cap method are shown in Large Figure 23 through Large Figure 27. The resulting concentration cap equations that are used in the probabilistic modeling are shown in Equations 8-24 through 8-28 (the equations are used for the pH range shown in Figure 8-19). For cobalt, manganese, nickel and zinc these equations have been developed by a visual fit of log-linear curves to the upper envelope of the AMAX dataset; the slope of each log-linear curve has been pre-defined based on the dominant valence state (ex.  $Ni^{2+}$  results in a log slope of -2). For copper, the polynomial equation is fit to a thermodynamic model of tenorite solubility, calibrated to match the upper envelope of the AMAX dataset.

This method provides a consistent means to develop pH-dependent concentration caps based on both AMAX and Category 1 data. Note that the SMWMP data for zinc are of the same magnitude as the AMAX data and the concentration cap relationship is not shifted. Because the SMWMP study did not indicate concentration caps for copper and nickel, the relationship for the AMAX data is used to conservatively estimate concentration caps for the Category 1 waste rock.

Cobalt:

$$\log \left[ Co \left( \frac{mg}{L} \right) \right] = -2 \cdot pH + 12.0 \quad (for \ pH < 7.5)$$

$$\log \left[ Co \left( \frac{mg}{L} \right) \right] = -pH + 4.5 \quad (for \ pH \geq 7.5)$$

**8-24**

Copper:

$$\log \left[ Cu \left( \frac{mg}{L} \right) \right] = -0.1623 \cdot pH^3 + 4.412 \cdot pH^2$$

$$-39.64 \cdot pH + 116.8 \quad (for \ 6.9 < pH < 8.2)$$

**8-25**



Date: February 13, 2015	NorthMet Project Waste Characterization Data Package
Version: 12	Page 91

Manganese:

$$\log \left[ \text{Mn} \left( \frac{\text{mg}}{\text{L}} \right) \right] = -\text{pH} + 6.1 \quad (\text{for } \text{pH} < 8)$$

$$\log \left[ \text{Mn} \left( \frac{\text{mg}}{\text{L}} \right) \right] = -4 \cdot \text{pH} + 30.1 \quad (\text{for } \text{pH} \geq 8)$$

**8-26**

Nickel:

$$\log \left[ \text{Ni} \left( \frac{\text{mg}}{\text{L}} \right) \right] = -2 \cdot \text{pH} + 15.0 \quad (\text{for } \text{pH} < 7.3)$$

$$\log \left[ \text{Ni} \left( \frac{\text{mg}}{\text{L}} \right) \right] = -\text{pH} + 7.7 \quad (\text{for } \text{pH} \geq 7.3)$$

**8-27**

Zinc:

$$\log \left[ \text{Zn} \left( \frac{\text{mg}}{\text{L}} \right) \right] = -2 \cdot \text{pH} + 13.7 \quad (\text{for } \text{pH} < 7)$$

$$\log \left[ \text{Mn} \left( \frac{\text{mg}}{\text{L}} \right) \right] = -\text{pH} + 6.7 \quad (\text{for } \text{pH} \geq 7)$$

**8-28**

### 8.3.1.6 Concentration Caps Dependent on pH (MDNR method)

The concentration caps approved by the Co-lead Agencies for the Category 1 waste rock make use of the AMAX pile data wherever possible. For this application, the AMAX data is restricted to the test piles with average sulfur contents of 0.64%. The uncertainty in the concentration cap at a given pH value (as simulated from Figure 8-19) is determined by a uniform distribution between the 95th percentile value and the maximum observed concentration at that pH. This method is used to simulate concentration caps for the following constituents: alkalinity, cobalt, copper, iron, potassium, manganese, sodium, nickel, and zinc. The bounding values from the AMAX data are presented in Large Table 12.

The concentration cap for aluminum is simulated as a function of pH according to Equation 8-29, which is based on modeled gibbsite mineral solubility over the pH range shown in Figure 8-19.

Aluminum:

$$\log \left[ \text{Al} \left( \frac{\text{mg}}{\text{L}} \right) \right] = 0.909 \cdot \text{pH} - 9.44$$

**8-29**

Like the PolyMet method above, the method approved by the Co-lead Agencies for developing a concentration cap for cadmium is to use the cadmium to zinc release ratio and the zinc concentration cap. The method for selenium is similar, with the selenium



Date: February 13, 2015	NorthMet Project Waste Characterization Data Package
Version: 12	Page 92

concentration cap equal to the sulfate concentration times the selenium to sulfate release ratio.

### 8.3.2 Duluth Complex Category 2/3/4 Waste Rock and Ore (nonacidic)

The concentration cap methods discussed below for the nonacidic Duluth Complex waste rock and pit walls represent the PolyMet method. For this temporary condition in the stockpiles and pit walls, the concentration caps approved by the Co-lead Agencies for the Category 1 waste rock has been used as directed by the Co-lead Agencies. The assumed pH range for this condition for the pH-dependent constituents described in Section 8.3.1.6 is 6 to 7.5 (uniform distribution), and the data from all AMAX piles is used (0.064% to 1.41% sulfur).

Sulfate concentrations for nonacidic Duluth Complex waste rock and pit walls are calculated based on the solubility of gypsum, as shown in Equation 8-19.

Where applicable, metal concentrations are constrained using AMAX test pile data (constituents include Co, Cu, Mn, Ni, Zn). The AMAX data have been shown to give a reasonable understanding of likely concentration caps for many constituents in the higher-sulfur Duluth Complex waste rock under nonacidic conditions (Attachment A). However, because of the size of the AMAX test piles and the locations from which water quality samples were collected, some samples may be affected by dilution effects from precipitation and runoff. In order to remove this influence from the data set, only observations that are in the upper 5% of the data set (for a given pH range) were used to construct probability distributions.

Within a given pH range (ex. 6.0 to 8.0), the AMAX data set was segregated into bins at 0.1 pH increments. The upper 5% of observed concentrations were extracted from each bin. These extracted observations were re-combined across the specified pH range and probability distributions were developed for the combined data set. Each of this limited set of observations is assumed to be an equally likely representation of concentration-capped conditions throughout the stockpiles.

For constituents not measured in the AMAX pile drainages, data from the Category 1 SMWMP study are used if the maximum concentration was not correlated with the sulfur content of the sample (alkalinity, Ag, Al, Fe, K, Na, Pb, Sb, Tl, V) (discussion of Category 1 study data treatment above). Whistle Mine acidic concentrations are used if the concentration cap study showed that sulfur concentrations are expected to be an important control (discussion of Whistle Mine data treatment below).

The probability distributions for the nonacidic Duluth Complex waste rock concentration caps are shown in Large Table 13 (method approved by the Co-lead Agencies) and Large Figure 28 through Large Figure 31 (PolyMet method).



Date: February 13, 2015	NorthMet Project Waste Characterization Data Package
Version: 12	Page 93

### **8.3.3 Duluth Complex Category 2/3/4 Waste Rock and Ore (acidic)**

Because the available data from the Whistle Mine are derived from groundwater wells beneath waste rock stockpiles or from leachate collected at the base of stockpiles, the data do not appear to be affected by the dilution issues evident in the AMAX data. All of the available data, therefore, can be used to represent solubility-limiting conditions at the low pH levels observed. Probability distributions have been developed for acidic conditions (all data with  $\text{pH} < 4.5$ ), with the assumption that each observation is an equally likely representation of concentration-capped conditions throughout the stockpiles under acidic conditions. The probability distributions for the acidic Duluth Complex waste rock concentration caps are shown in Large Table 14 and Large Figure 32 through Large Figure 36.

### **8.3.4 Virginia Formation Category 4 Waste Rock**

The Vangorda Mine data have been used to develop concentration caps for the Virginia Formation waste rock for all constituents except Cd, Pb and Zn, which are mineralized in the Vangorda Mine deposit and are not analogous to the NorthMet Virginia Formation waste rock. Concentration caps for these constituents (Cd, Pb, Zn) have been developed using the Whistle Mine data. The Vangorda Mine data are used in the same manner as the Whistle Mine data, with the assumption that each observation is an equally likely representation of concentration-capped conditions throughout the Virginia Formation waste rock. The probability distributions for the Virginia Formation Category 4 waste rock concentration caps are shown in Large Table 15 and Large Figure 37 through Large Figure 41.

## **8.4 Additional Model Parameters and Considerations**

### **8.4.1 Depletion**

The water quality model includes a check for depletion of each modeled constituent from each waste rock stockpile and category of pit wall. This ensures that any simulated very high metal leaching rates do not continue, but consume the available metals within an appropriate time frame and cease.

The weighted average content of each constituent in each waste rock type was determined from the NorthMet drill core data set, using the methods described in Section 8.1.2. The average sulfate content for each waste rock type was obtained from the Block Model. These weighted average values are considered to be deterministic in the water quality modeling and are shown in Table 8-8.

**Table 8-8 Average Metal Content from Aqua Regia Data (ppm)**

Constituent	Category 1 Waste Rock	Category 2/3 Waste Rock	Duluth Complex Category 4 Waste Rock	Virginia Formation Category 4 Waste Rock	Ore
Silver (Ag)	1.35E-01	2.80E-01	3.63E-01	3.61E-01	1.31E+00
Aluminum (Al)	4.07E+04	3.86E+04	4.04E+04	3.23E+04	3.84E+04
Alkalinity <sup>(1)</sup>	--	--	--	--	--
Arsenic (As)	2.47E+00	3.52E+00	1.99E+01	3.20E+01	6.92E+00
Boron (B)	7.94E+00	7.32E+00	9.16E+00	8.82E+00	5.02E+00
Barium (Ba)	4.07E+01	4.85E+01	5.57E+01	1.04E+02	4.72E+01
Beryllium (Be)	2.43E-01	2.66E-01	6.15E-01	5.77E-01	1.81E-01
Calcium (Ca)	2.22E+04	2.18E+04	1.79E+04	5.93E+03	2.11E+04
Cadmium (Cd)	4.19E-01	4.59E-01	7.34E-01	1.42E+00	9.72E-01
Chlorine (Cl) <sup>(1)</sup>	--	--	--	--	--
Cobalt (Co)	4.83E+01	4.99E+01	6.05E+01	2.56E+01	7.48E+01
Chromium (Cr)	1.01E+02	8.74E+01	1.23E+02	1.86E+02	8.26E+01
Copper (Cu)	2.15E+02	7.47E+02	7.18E+02	2.17E+02	3.58E+03
Fluoride (F) <sup>(1)</sup>	--	--	--	--	--
Iron (Fe)	6.17E+04	5.97E+04	5.47E+04	5.28E+04	7.14E+04
Potassium (K)	1.40E+03	1.72E+03	2.66E+03	8.18E+03	1.75E+03
Magnesium (Mg)	4.00E+04	3.30E+04	2.00E+04	1.37E+04	3.63E+04
Manganese (Mn)	7.01E+02	6.28E+02	3.69E+02	2.43E+02	6.65E+02
Sodium (Na)	5.80E+03	5.12E+03	3.40E+03	9.94E+02	4.87E+03
Nickel (Ni)	2.55E+02	3.29E+02	3.33E+02	1.35E+02	9.72E+02
Lead (Pb)	2.45E+00	2.52E+00	5.10E+00	5.87E+00	6.22E+00
Antimony (Sb)	1.34E+00	1.31E+00	1.48E+00	1.74E+00	1.78E+00
Selenium (Se) <sup>(1)</sup>	--	--	--	--	--
Sulfur (S) <sup>(2)</sup>	6.40E+02	2.10E+03	9.50E+03	2.43E+04	9.00E+03
Thallium (Tl)	4.78E+00	4.74E+00	4.75E+00	4.30E+00	3.40E+00
Vanadium (V)	3.32E+01	3.77E+01	9.11E+01	1.36E+02	3.69E+01
Zinc (Zn)	6.83E+01	7.18E+01	1.04E+02	2.51E+02	8.11E+01

(1) Aqua regia data not available for alkalinity, chlorine, fluoride and selenium. No depletion is modeled.

(2) Sulfur values are from the Block Model, not the aqua regia dataset.

### 8.4.2 Nitrogen in Waste Rock

Nitrogen by-products of explosives used in rock blasting can leach from waste rock and pit walls, potentially causing exceedances of water quality standards. The applicable water quality standards are for nitrate plus nitrite in groundwater (10 mg/L as N) and for un-ionized ammonia in Class 2B surface waters such as the Partridge River (0.040 mg/L as N).

The total quantity of nitrogen in explosives residue is dependent on the nitrogen content of the explosives, the quantity of explosives used and the efficiency of detonation. Empirical relationships have been developed that account for the efficiency of detonation of each type of explosives (Reference (29)). Using these standard methods and PolyMet's expected explosives usage and characteristics (Table 8-9), the total nitrogen available for leaching (i.e., the nitrogen in the explosive residue) from each unit of waste rock can be calculated based on Equations 8-30 and 8-31, with variable names and units as defined in Table 8-9.

N usage: 
$$N_U = P \times C \times U \quad \mathbf{8-30}$$

N residue: 
$$N_R = 0.94\%N_U^{ANFO} + 5.1\%N_U^{Emulsion} \quad \mathbf{8-31}$$

The disposition of nitrogen in the explosive residue that remains with the waste rock is assumed to be expressed as 87% NO<sub>3</sub>, 11% NH<sub>3</sub> and 2% NO<sub>2</sub>. The resulting loading of each type of nitrogen from the waste rock is shown in Table 8-10.

**Table 8-9 Nitrogen Leaching Input Information**

Parameter	Symbol	Units	ANFO	Emulsion
Maximum powder factor (explosives per unit rock)	P	kg/mton	0.35	
Explosives N content	C	%	35%	26%
Explosives usage	U	%	30%	70%
N usage	N <sub>U</sub>	kg N/mton	0.0368	0.0637
N residue	N <sub>R</sub>	kg N/mton	0.00359	

**Table 8-10 Nitrogen Leaching Outputs**

Parameter	Symbol	Units	Value
Nitrate leached	NO <sub>3</sub>	kg as N/mton	0.00313
Ammonia leached	NH <sub>3</sub>	kg as N/mton	0.00040
Nitrite leached	NO <sub>2</sub>	kg as N/mton	0.00007

Date: February 13, 2015	NorthMet Project Waste Characterization Data Package
Version: 12	Page 96

It should be noted that nitrogen leaching from explosives residue is a one-time load dependent on the quantity of waste rock and is not expressed as a release rate or ongoing load like the other solutes discussed in this document. If all nitrogen is assumed to leach within the first year after rock is placed in the stockpile, the maximum potential impact from nitrogen leaching for a given waste rock stockpile (maximum leachate concentrations) occurs when the largest quantity of freshly-blasted waste rock is placed in the stockpile with the smallest footprint area (and therefore the lowest infiltration volume for dilution). For the NorthMet stockpiles, this maximum impact will occur in Mine Year 1, when relatively large quantities of waste rock are placed in relatively small stockpiles. Although the total mass of waste rock per acre is greater in later years of mining, the mass per acre *added* in Mine Year 1 is the largest for all stockpiles (Table 8-11).

**Table 8-11 Stockpile Nitrogen Leaching Critical Conditions**

Stockpile	Maximum New Material (tons/acre)	Mine Year
Category 1	87,800	1
Category 2/3	84,500	1
Category 4	51,700	1
Ore Surge Pile	32,300	1

A scoping-level calculation was performed for the nitrogen leaching from the Category 2/3 Waste Rock Stockpile in Mine Year 1. This stockpile has the largest initial mass of waste rock ( $M_S = 5,238,766$  tons at the end of Mine Year 1) of the NorthMet stockpiles that have geomembrane liners and liner leakage that reports to groundwater flow paths (i.e., excluding the Category 1 Waste Rock Stockpile). At the end of Mine Year 1 the footprint area of the Category 2/3 Waste Rock Stockpile is 62 acres ( $A_S$ ). This stockpile also has the shortest groundwater flow distance to the property boundary or the Partridge River ( $L_N = 600$  feet), the potential point of compliance with groundwater standards. These conditions combine to make the Category 2/3 Waste Rock Stockpile the worst-case example of nitrogen leaching for the NorthMet stockpiles.

A simple mixing model was constructed for a flow path passing under the Category 2/3 Waste Rock Stockpile and ending at the property boundary. The assumptions for this scoping-level analysis are described in Table 8-12 and the model is shown in Equations 8-32 through 8-34.

**Table 8-12 Scoping Model Inputs for Nitrate**

Parameter	Symbol	Units	Value	Notes
Stockpile source length	$L_S$	ft	1,350	Width of stockpile in direction of flow path
Stockpile N loading	$N_{S,nit}$	kg as N/mton	0.0032	Sum of $NO_3$ and $NO_2$ from Table 8-10
	$N_{S,amm}$	kg as N/mton	0.0004	$NH_3$ from Table 8-10
Stockpile infiltration	$I_S$	in/yr	random	Probabilistic model as defined in Reference (30) Section 4.3
Liner leakage	$LL$	--	random	Probabilistic model as defined in Reference (30) Section 4.3
Mean natural area recharge	$R_N$	in/yr	0.5	Partridge River baseflow suggests recharge of between 0.55 and 0.85 in/yr
Mean recharge concentration	$C_{N,nit}$	mg as N/L	1.42	$NO_3 + NO_2$ , highest value observed at Mine Site, mean is 0.31
	$C_{N,amm}$	mg as N/L	0.42	$NH_3$ , highest value observed at Mine Site, mean is 0.074

Stockpile concentration: 
$$C_S = \frac{N_S M_S}{I_S A_S 1year} \quad \mathbf{8-32}$$

Leakage to flow path: 
$$R_S = I_S LL \quad \mathbf{8-33}$$

Mixed concentration: 
$$C_{mix} = C_S \left( \frac{R_S L_S}{R_S L_S + R_N L_N} \right) + C_N \left( \frac{R_N L_N}{R_S L_S + R_N L_N} \right) \quad \mathbf{8-34}$$

This simple model conservatively assumes that 100% of the nitrogen available to leach from the waste rock deposited in the stockpile during the first year of mining does so evenly throughout a single year. If this leaching process took more time or had a correction for water contact, the resulting concentrations at the bottom of the stockpile would be lower. The model also makes the conservative assumption that the liner leakage from the stockpile is instantly mixed with the recharge water along the flow path, using a lower mean recharge rate and higher mean concentration than indicated by the available data.

Most importantly, the scoping-level model assumes that nitrogen mass is conserved along a groundwater flow path and that there is no net uptake by vegetation or denitrification and loss to the atmosphere. Given the relatively long travel times (decades to breakthrough) associated with flow through the surficial material at the Mine Site, this is a conservative assumption. It is highly likely that any nitrogen released from the waste rock stockpiles will be consumed by biologic activity long before reaching the property boundary or the Partridge River.

In order to quantify the impact of the uncertainty in stockpile hydrology (infiltration and liner leakage), the simple mixing model was run as a Monte Carlo simulation with 5,000 realizations in the GoldSim software (Section 3.0 of Reference (30)). The only inputs to this model that were defined as probability distributions (accounting for uncertainty and variability) were the stockpile hydrology variables—the remaining variables were defined with the conservative assumptions described above.

The intermediate model results for the concentration of nitrate plus nitrite in stockpile seepage ( $C_s$  in Equation 8-32) are shown in Figure 8-20. Using the conservative assumptions defined here, the concentration leaving the Category 2/3 Waste Rock Stockpile could range from approximately 100 to 300 mg/L (as N), with a mean of 180 mg/L (as N). Compared to nitrate seepage data from other cold-climate (Canada) mines with granitic waste rock (Table 8-13), these values are on the high end of the observed range. This observation confirms the conservative nature of the scoping-level model performed here.

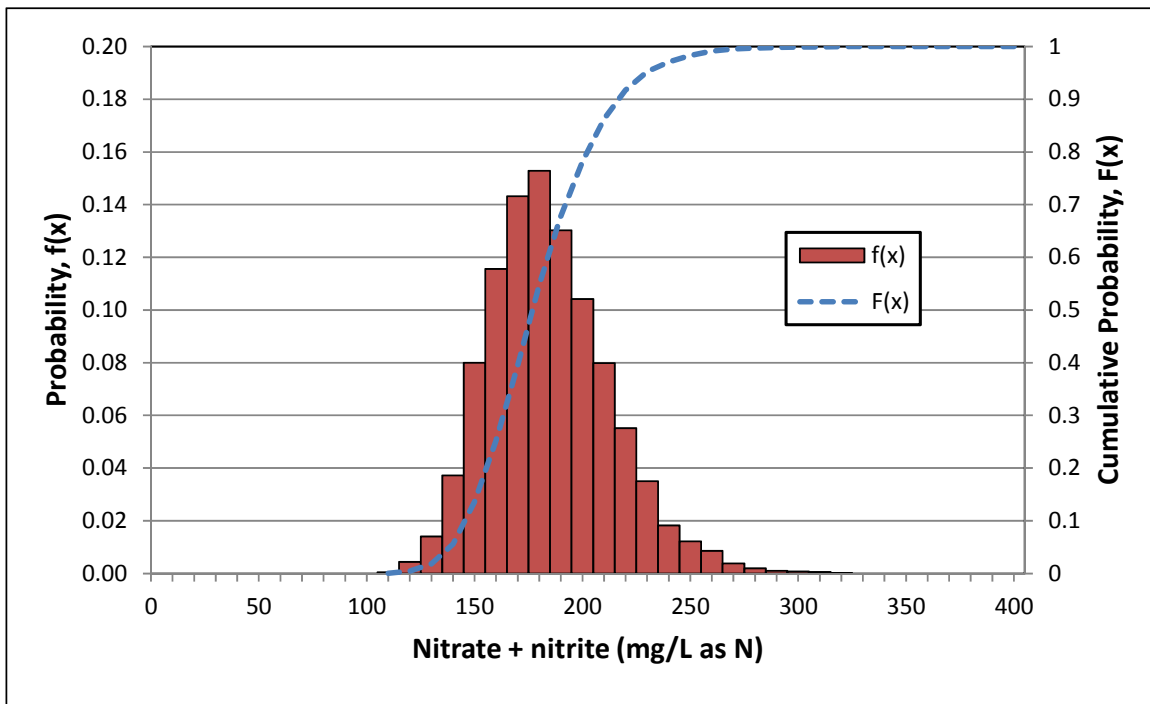

Figure 8-20 Scoping Model Results for Nitrate in Stockpile Seepage

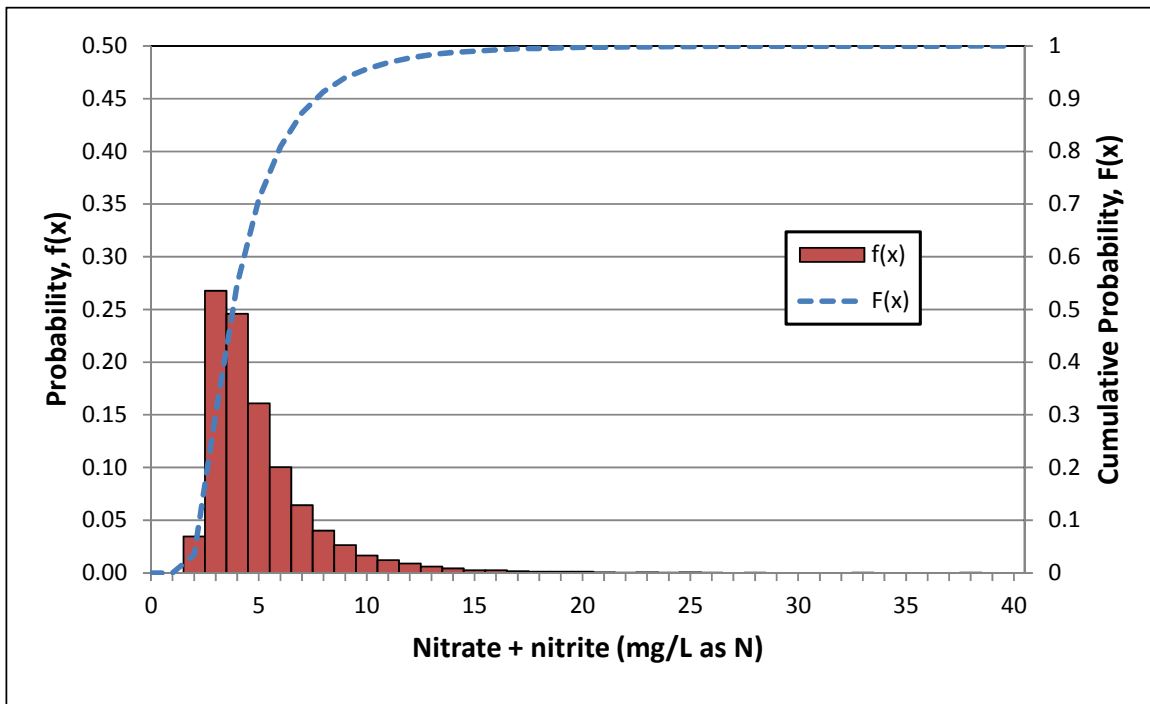

**Table 8-13 Cold Climate Waste Rock Seepage Nitrate Concentrations**

Mine	Commodity	n	Min (mg/L)	Median (mg/L)	95 <sup>th</sup> %ile (mg/L)	Max (mg/L)
Panda	Diamond	27	< 0.006	23.8	180	218
Misery	Diamond	31	0.334	13.3	81.8	143
Gibraltar	Copper, molybdenum	19	0.009	1.1	16.5	19.7
Mt. Polley	Copper, gold	13	0.013	11.9	31.9	32.3

Source: SRK project files

The model results for the groundwater concentration at the property boundary are shown as probability distributions in Figure 8-21 for nitrate plus nitrite and Figure 8-22 for ammonia.



**Figure 8-21 Scoping Model Results for Nitrate at the Property Boundary**

As shown in Figure 8-21, the scoping-level mixing model shows that nitrate plus nitrite concentrations in groundwater at the NorthMet property boundary are highly likely to be below the applicable groundwater quality standard of 10 mg/L. Despite the conservative nature of the simple mixing model and the conservative input assumptions, less than 5% of

the model simulations had nitrate plus nitrite concentrations greater than 10 mg/L. Given that this model does not include the effects of biologic activity, the likely impacts to groundwater from nitrogen leaching can be considered to be negligible.

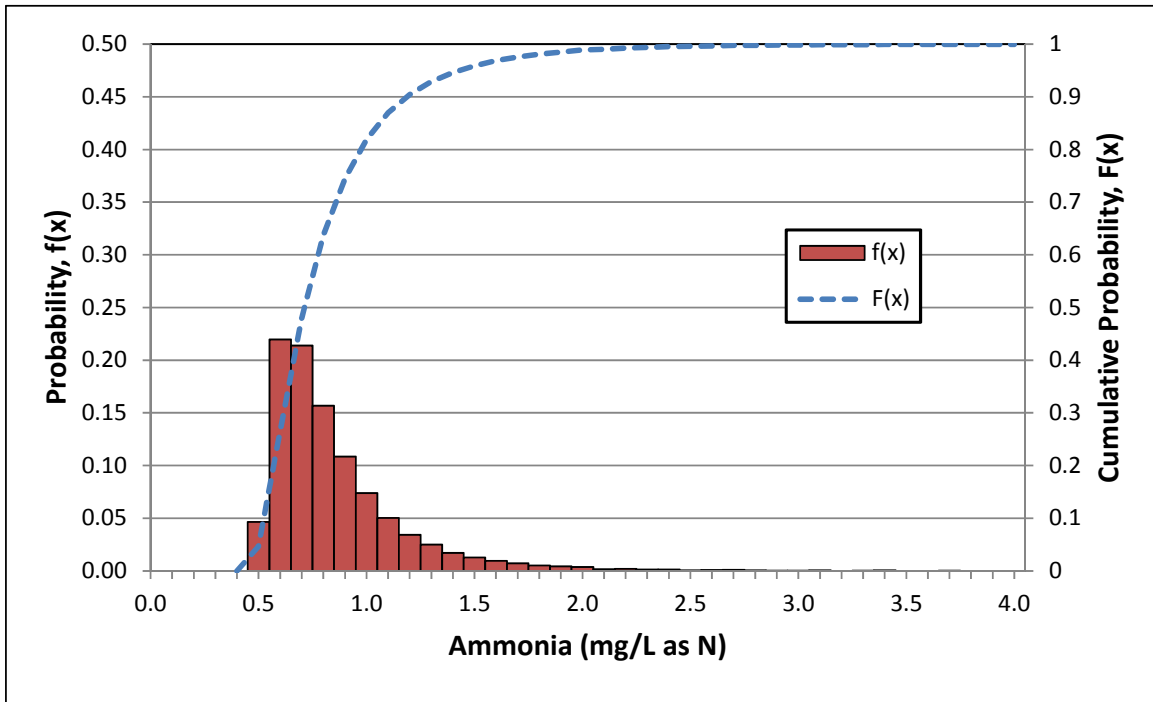

**Figure 8-22 Scoping Model Results for Ammonia at the Property Boundary**

As shown in Figure 8-22, the scoping-level mixing model shows that ammonia concentrations in groundwater at the NorthMet property boundary have a less than 5% probability of being greater than 1.5 mg/L (as N). At the average surficial groundwater temperature (7.7°C) and pH (7.7), un-ionized ammonia will represent less than 1% of the total ammonia in solution. The resulting un-ionized ammonia concentration at an ammonia concentration of 1.5 mg/L would be approximately 0.01 mg/L (as N), well below the surface water quality standard of 0.04 mg/L. Given the conservative nature of this model and that it does not include the effects of biologic activity, the likely impacts to surface water from nitrogen leaching can also be considered to be negligible.

Nitrogen from explosive residue is therefore not included in the probabilistic modeling of the waste rock stockpiles. Section 9.6.3 for analysis of the potential impacts from the flooded mine pits.

### 8.4.3 Ore Spillage from Rail Cars

Concerns were raised in the NorthMet Impact Assessment Planning process regarding the potential for water quality impacts due to the spillage of ore from rail cars along the rail



Date: February 13, 2015	NorthMet Project Waste Characterization Data Package
Version: 12	Page 101

transfer corridor. Spillage of ore and mineral concentrates at other operations has, in some cases, resulted in contamination of soil and water bodies along the associated transportation corridors. For the Project, the proposed transportation of ore to the Plant Site is in rail cars along an existing rail corridor that traverses wetlands and crosses two streams.

Table 8-14 provides an estimate of the quantity of fine ore material that could spill from rail cars within the first 1,000 meters of the transfer corridor. Assuming that all spillage occurs in a 2 meter wide strip along this portion of the rail corridor, it is estimated that approximately 2.78 kg/m<sup>2</sup> could spill annually or 55.7 kg/m<sup>2</sup> over the 20-year life of the project. This is equivalent to 1.25 inches of spilled material over a 2,000 m<sup>2</sup> area.

Rail cars similar to those that will be used for the Project are currently in use at a Carmeuse Limestone operation in Michigan's Upper Peninsula. According to mine representatives, little or no spillage of fine material has been observed along the mainline tracks (Reference (31)). Some spillage occurs in the crusher building due to frequent stops and starts of the rail cars, and some fine material may be washed through the rail car doors by heavy rains. In general, however, there is no evidence of continued spillage along the main rail line. This information suggests that the spillage estimates provided here are conservative maximum values.

Preliminary modeling using the geochemical inputs discussed in this section for the spilled ore suggests that the rainfall contacting spilled ore material has the potential to exceed surface and groundwater quality standards at the source (i.e., including only rainfall over the 2,000 m<sup>2</sup> area and no other dilution). Water quality at points of compliance, such as within wetlands or streams adjacent to the rail corridor, will be better than the water quality at the spilled material due to dilution from other contributing areas, which may be significant.

If the spilled material is deposited evenly over the entire 13-km rail corridor rather than the first 1,000 meters as assumed here, the total quantity of spillage over the 20-year life of the project would be 4.28 kg/m<sup>2</sup> (assuming a 2 meter wide strip), or 0.1 inches of depth. Note that the streams traversed by the rail corridor are farther than 1,000 meters from the Rail Transfer Hopper. This small quantity of expected spilled material will also tend to become depleted of sulfide minerals quite rapidly compared to a waste rock stockpile. Nonetheless, impacts to surface and groundwater from rail car spillage cannot be dismissed.

In order to quantify the potential indirect impacts to wetlands along the rail corridor, the estimated spillage over the entire 13-km corridor is used with the modeling methods presented in this document to estimate the quality of water contacting this spilled material. The spilled ore is modeled according to the following assumptions:

- humidity cell rates as defined for the "ore composite" case in Section 8.1
- water contact factor equal to 1.0 (assumed complete rinsing)



Date: February 13, 2015	NorthMet Project Waste Characterization Data Package
Version: 12	Page 102

- particle size factor equal to 1.0 (assumed particle size distribution identical to humidity cells)
- temperature factor uncertainty as defined in Section 8.2.4
- acidification factor and time to acidification uncertainty as defined in Section 8.2.5
- concentration caps as defined in Sections 8.3.1.6 and 8.3.3
- depletion as defined in Section 8.4.1
- annual water contact as defined for the bare stockpile case in Reference (30), Section 6.1.1, assuming that annual water contact (infiltration or runoff) equals precipitation minus evaporation

The results of this modeling include an estimate of the quality of water at the source of spillage as well as the additional dilution necessary to bring estimated concentrations below water quality standards. The dilution amount is expressed in terms of distance from the rail centerline, resulting in an estimated width of potential indirect impacts to wetlands.

The data needed for precise estimates of impacts from rail spillage is not available. The amount of likely spillage and the size of the material spilled can only be estimated; the precise location and physical distribution of spillage is unknown; the hydrology of the spilled material and the amount of dilution that could be expected before reaching points of compliance are highly site-specific.

In order to guard against possible adverse impacts from spilled ore, monitoring and mitigation activities can be developed. It is expected that surface water quality sampling in the two streams traversed by the rail line will be included in permit monitoring. Mitigation measures could include alterations to the stream crossings (bridges or culverts) to collect any spilled material or the physical collection of spilled ore from the top of the rail ballast.

**Table 8-14 Estimate of Potential Rail Car Ore Spillage**

Characteristic and Units	Value
<b>Tons of ore transported per year</b>	<b>11,680,000</b>
<b>Size Distribution of Blasted Ore from blast fragmentation model</b>	
% by weight less than 2" from blast fragmentation model	6.00%
Tons of Ore per Year of a size that could fit through potential side door gaps	700,800
% by weight less than 1/2" (assume linear from 2" to zero)	1.50%
Tons of Ore per Year of a size that could fit through potential hinge gaps	175,200
<b>Rail Car Characteristics</b>	
Car length (ft)	33.75
Car width (ft)	8.67
Car side height (ft)	3.88
Car volume (ft <sup>3</sup> )	1,133
Hinge gap width (in)	0.50
Side door to carbody end gap (in)	2.00
Car volume within 2" of side door gap (ft <sup>3</sup> ) [This material would have to be adjacent to gap to fall out but would not move much]	0.43
Percent of car volume within 2" of side door gaps	0.04%
Car volume within 1.5" (3 diameters) of hinge gap (ft <sup>3</sup> ) [This material would have to be adjacent to gap to fall out and could move in the car]	1.05
Percent of car volume within 1.5" (3 diameters) of hinge gap	0.09%
<b>Computed Mass</b>	
Tons of <2 " ore per year that could reach side door gaps (assuming no size classification) (700,800 tons x 0.04%)	266
Percent of <2 " ore not classified to center of car [Most fines sift straight down - very good size classification on pan feeder plus additional classification as feeder feeds to center of car]	2.00%
Tons of <2 " ore per year close enough to side gap to fall out (266 tons x 2%)	5.32
Tons of <1/2 " ore per year that could reach hinge gaps (assuming no size classification) (172,200 tons x 0.09%)	163
Percent of <1/2 " ore not classified to center of car [Most fines sift straight down - very good size classification on pan feeder plus additional classification as feeder feeds to center of car]	0.50%
Tons of <1/2 " ore per year close enough to hinge gap to fall out (163 tons x 0.5%)	0.82



Date: February 13, 2015	NorthMet Project Waste Characterization Data Package
Version: 12	Page 104

Characteristic and Units	Value
<b>Potential Spillage</b>	
Tons of ore per year potentially spilled (side gaps and hinge gap)	6.14
Kg of ore per year potentially spilled (side gaps and hinge gap)	5570
Kg of ore per year potentially spilled per square meter along track [assume all spills out in first 1000 meters in 2 meter width]	2.78
Kg per square meter of potential spillage for 20-year mine life	55.70
<b>Approximate total depth of spillage for 20-year mine life (inches)</b>	<b>1.25</b>
<b>Approximate annual depth of spillage (inches)</b>	<b>0.06</b>

#### 8.4.4 Chloride Release from Waste Rock

Chloride release is included in the probabilistic model of Mine Site water quality in a different manner from the other constituents modeled. Chloride leaching from blasted waste rock is observed as a one-time process with no solubility effects, similar to nitrate leaching. The chloride originates from the bedrock or groundwater within the bedrock but is not continuously released during rock weathering.

Humidity cell data indicates that chloride release for the project samples (all rock types and categories considered together) ranges from less than 1 mg Cl per kg rock (ppm) to more than 70 ppm, with a median of 4.5 ppm. The beta distribution fit to the chloride release from all NorthMet humidity cells is shown in Figure 8-23.

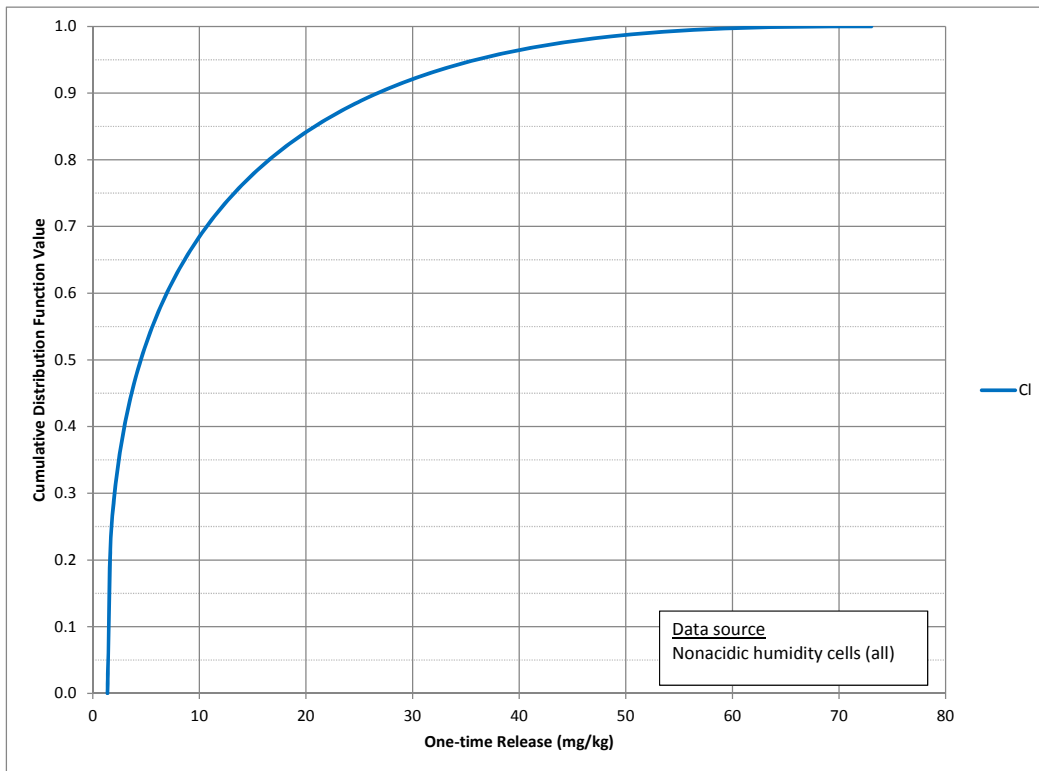

**Figure 8-23 Distribution for One-Time Chloride Release**

Chloride release in the probabilistic model is converted from a one-time release to a release rate (mg/kg/week, the same as the other constituents) by multiplying the randomly-simulated value from Figure 8-23 by the fractional rate at which waste rock is added to the stockpile (mass added per time period divided by total stockpile mass). Chloride release, therefore, will only occur while new rock mass is added to the stockpile. The release rate is scaled to field conditions to account for differences in water contact and particle size (Section 8.2) between the laboratory and field, but is not scaled by the temperature correction factor.



Date: February 13, 2015	NorthMet Project Waste Characterization Data Package
Version: 12	Page 106

## 9.0 Geochemical Parameters – Pit Lake

This section covers geochemical parameters relating to pit wall rock and the pit lake that are used in water quality modeling.

### 9.1 Laboratory Release Rates

Constituent release rates for the pit wall rock are simulated using identical methods as for the waste rock stockpiles, described in Section 8.1. The simulated release rates are applied to the applicable portions of the pit walls by rock category and geology. Ore portions of the pit walls are simulated as discussed in Section 8.1, with probability distributions drawn from Category 2/3 humidity cells (with the exception of sulfate) and ore drill cores. This is a slight change from previous geochemical modeling of the pit wall rock (References (32) and (12)), in which wall rock classified as ore was modeled identically to Category 2/3 wall rock.

In closure, the Virginia Formation portions of the East Pit highwall would be treated with crushed limestone and capped with overburden and a permanent geomembrane cover (Reference (9)). The geomembrane would reduce the availability of oxygen to the wall rock, which would inhibit the oxidation of sulfide minerals and accompanying constituent release. The amount of limestone would be designed to provide sufficient buffering capacity to create neutral or near-neutral conditions along the wall rock, rather than the acidic conditions common for oxidizing Virginia Formation rock. The combined effect of these treatments would be a dramatic reduction in oxidation rates and constituent release from the covered portions of the East Pit highwall. Because no data exists for Virginia Formation oxidation under nonacidic conditions, however, the constituent release rates for this segment of pit wall are conservatively assumed to remain unchanged from those presented in Section 8.1. This treatment is modeled as primarily affecting the applicable concentration caps for exposed Virginia Formation wall rock (nonacidic caps instead of acidic caps), Section 9.5.1.

### 9.2 Mass of Reactive Wall Rock

The surface area of each category of wall rock that is subject to oxidation is determined from the Mine Plan as a function of elevation for a given year of mine development. The plan view surface area (looking downward) is used to reflect that the majority of the fractured wall rock is located on horizontal benches rather than on the sloped walls due to the expected blasting patterns (Reference (32), Section 5.3).

In the deterministic modeling, a thickness of 2 meters was used to represent the average thickness of reactive wall rock throughout the entire pit. This value is derived from the depth of expected over-drilling during blasting and wall rock fracturing below the removal zone. In order to reflect the uncertainty in this thickness, the distribution previously proposed is a triangular distribution of  $\pm 50\%$  of the deterministic value, or from 1 to 3 meters. This distribution is applied to all wall rock with the exception of the Virginia Formation Category 4 wall rock. For the Virginia Formation Category 4 wall rock, the distribution for wall



thickness is a triangular distribution from 2 to 6 meters. See Figure 9-1 for these distributions.

In addition to the pit walls blasted into the bedrock, the probabilistic modeling also considers the potential loading from the 20-foot pit rim set back at the top of the rock walls. This rock will not be blasted and is expected to be more competent than bedrock exposed on in-pit benches; however, the removal of some or all of the overlying surficial material will expose this rock to oxidation and freeze-thaw weathering. These areas are modeled identically to the blasted pit walls but with the thickness reduced by a factor of 10. The resulting range of reactive thickness for the pit rim set back is 10 cm to 30 cm for Duluth Complex and 20 cm to 60 cm for the Virginia Formation Category 4 wall rock.

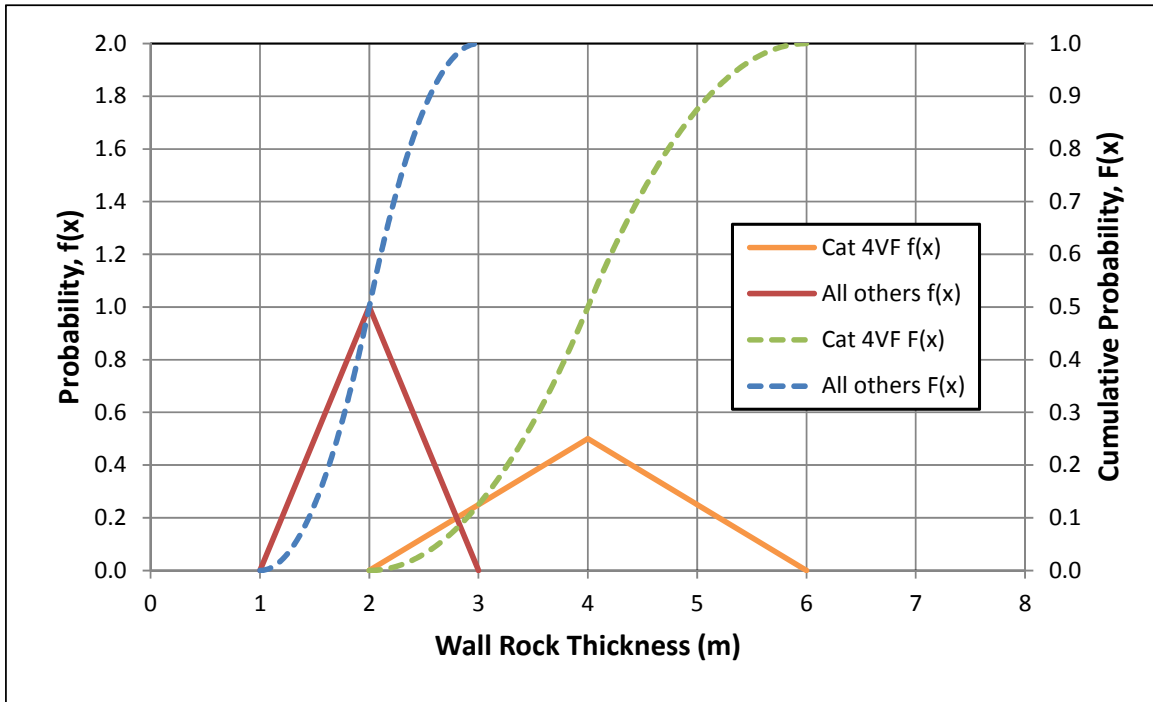

Figure 9-1 Wall Rock Thickness Distribution

### 9.3 Lab to Field Scale-Up

In general, scaling from laboratory to field scale constituent release for the pit wall rock is performed in a similar manner as for the waste rock. The pit walls are assumed to behave much like stockpiles of waste rock, with competent but fractured bedrock on the benches and pit walls and accumulated talus material that is exposed to oxygen as in the waste rock stockpiles.

The scale-up factor is applied to the nonacidic laboratory release rates (from the humidity cell tests) in order to calculate release rates from full scale wall rock. The bulk scale-up

Date: February 13, 2015	NorthMet Project Waste Characterization Data Package
Version: 12	Page 108

factor ( $S_B$ ) is dependent on three sub-factors that represent the effects of differences between laboratory and field conditions with respect to the water contact ( $k_c$ ), particle size ( $k_s$ ), and temperature ( $k_t$ ). Note that unlike the scale-up for waste rock stockpiles there is no acidity factor in Equation 9-1; the effects of acidification and subsequent decay are modeled differently for the pit wall rock as described in Section 9.4.

$$S_B = k_t * k_s * k_c \quad \mathbf{9-1}$$

### 9.3.1 Water Contact Factor

The water contact factor for the pit wall rock  $k_c$  is modeled using the same distribution as discussed in Section 8.2.2 and shown in Figure 8-8 for the waste rock stockpiles. For the pit walls and the waste rock backfilled into the East Pit, the fraction of released constituent mass that is not contacted by percolating water ( $1 - k_c$ ) is assumed to be entirely flushed into the pit water when each segment of wall or backfill is inundated.

### 9.3.2 Particle Size Factor

The particle size factor for the pit wall rock  $k_s$  was assumed to equal 0.10 in the deterministic modeling. This is half of the value that was used for the waste rock in stockpiles, reflecting the fact that the fractured wall rock is expected to contain fewer fine particles and a larger proportion of very large blocks. The proposed distribution for the wall rock size factor is a uniform distribution of  $\pm 50\%$  of the deterministic value, or from 0.05 to 0.15. This range reflects the relatively large uncertainty in this factor and is shown in Figure 9-2.

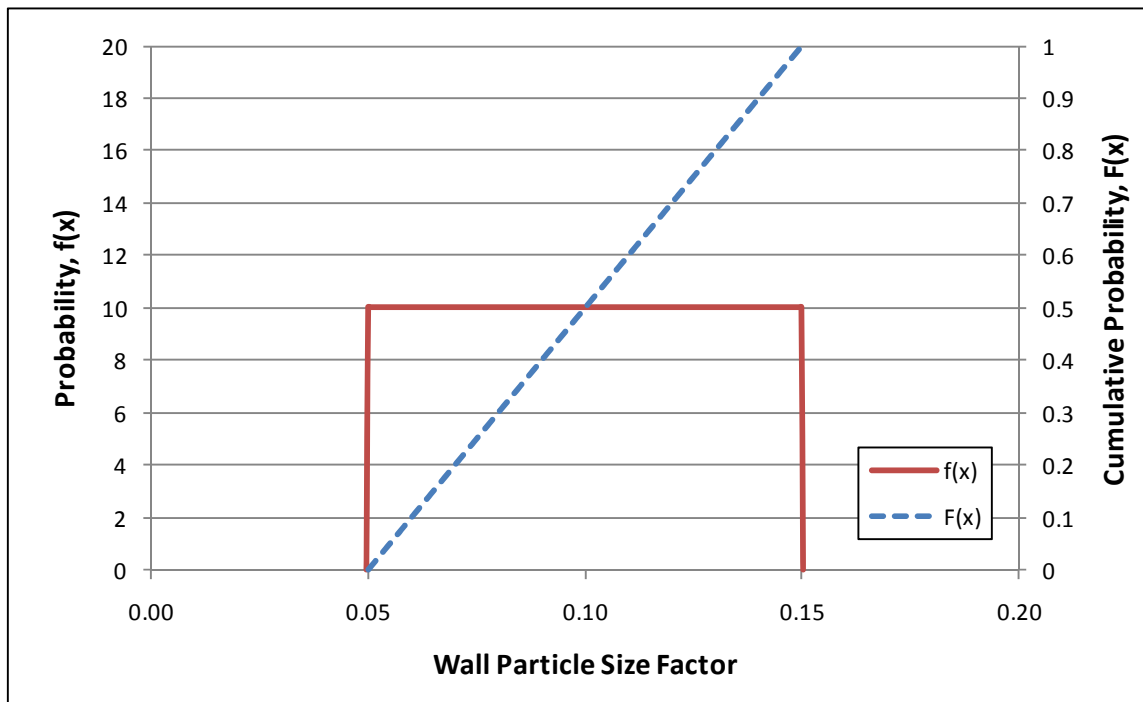

**Figure 9-2 Wall Particle Size Factor Distribution**

### 9.3.3 Temperature Factor and Solar Heating

The expected temperature factor  $k_t$  for the pit wall rock can be calculated in a manner similar to that for the waste rock stockpiles, using the Arrhenius equation (Equation 8-16). It is assumed that the release of heat from oxidation of the relatively thin veneer of pit wall rock is not sufficient to increase the temperature of the walls. The average temperature of the pit wall rock will then be governed by the distribution for the average air temperature at the site, similar to the Category 1 Waste Rock Stockpile (Figure 8-10). Because the wall rock is geochemically identical to the waste rock, the same distribution for the activation energy applies (Figure 8-11).

Because the proposed mine pits have their long axes oriented east-west, questions have been raised regarding whether the south-facing pit walls (the northern wall of each pit) will have increased temperature and therefore increased oxidation due to solar heating. The following analysis is designed to determine the approximate magnitude of temperature increase (above ambient air temperatures) in this portion of the pit walls due to solar heating. This analysis is based on thermodynamic principles and equations found in Reference (33) and the assumed thermodynamic properties of stone and air shown in Table 9-1.

**Table 9-1 Thermodynamic Input Assumptions**

Parameter	Symbol	Units	Value
Daily temperature oscillation frequency	$\omega$	1/s	$7.27 \times 10^{-5}$
Thermal diffusivity of stone <sup>(1)</sup>	$\alpha$	m <sup>2</sup> /s	$7.4 \times 10^{-7}$
Stone emissivity <sup>(2)</sup>	$\epsilon$	--	0.80
Stone reflectance <sup>(3)</sup>	$\alpha_{\text{solar}}$	--	0.20
Stone thermal conductivity <sup>(1)</sup>	$k_{\text{stone}}$	W/mK	1.6
Stefan-Boltzmann constant <sup>(1)</sup>	$\sigma$	W/m <sup>2</sup> K <sup>4</sup>	$5.67 \times 10^{-8}$
Air kinematic viscosity at 320°K <sup>(1)</sup>	$\nu$	m <sup>2</sup> /s	$1.75 \times 10^{-5}$
Air Prandtl number at 320°K <sup>(1)</sup>	Pr	--	0.708
Air thermal conductivity at 320°K <sup>(1)</sup>	$k_{\text{air}}$	W/mK	0.0275

(1) Reference (33)

(2) Low-end value for stone taken from literature. See examples for various materials at [www.engineeringtoolbox.com/emissivity-coefficients-d\\_447.html](http://www.engineeringtoolbox.com/emissivity-coefficients-d_447.html). Typical  $\epsilon$  for concrete is 0.85.

(3) Low-end value for stone taken from literature. See examples of (1 -  $\alpha_{\text{solar}}$ ) for various materials at [http://www.engineeringtoolbox.com/solar-radiation-absorbed-materials-d\\_1568.html](http://www.engineeringtoolbox.com/solar-radiation-absorbed-materials-d_1568.html). Typical  $\alpha_{\text{solar}}$  for concrete is 0.40.

The increase in temperature at the rock surface above mean daily air temperature ( $\Delta T$ ) can be defined by performing an energy balance for the rock face. Energy inflows are short-wave solar radiation ( $q_s$ ) and long-wave radiation absorbed from the atmosphere ( $q_a$ ), energy outflows are reflected solar radiation ( $q_r$ ), long-wave radiation emitted from the rock face ( $q_e$ ), convective heat transfer from the rock face to the air ( $q_{\text{conv}}$ ) and conduction of heat into the wall ( $q_{\text{cond}}$ ):

$$q_s + q_a = q_r + q_e + q_{\text{conv}} + q_{\text{cond}} \quad \mathbf{9-2}$$

The energy inflows on the left side of the equation can be determined from regionally-available data. The energy outflows on the right side of the equation are functions of the rock surface temperature and can be used to solve for the rock temperature.

### 9.3.3.1 Solar Radiation

The solar radiation incident on a horizontal plane surface was measured at St. Paul, Minnesota as part of climatological studies in the 1970s (Reference (34)). The study used measurements from multiple years to determine the median peak daily radiation at the summer solstice in June and at the winter solstice in December (Table 9-2). In addition, the study also measured the solar radiation incident on a south-facing plane inclined 55° to the horizontal. Radiation on this face, which approximates conditions on an inclined pit wall, was less than on the horizontal plane in June and greater in December (i.e., the inclined plane is a more efficient collector of winter solar radiation but less efficient in the summer). Using

these ratios, the median peak daily solar radiation on the pit wall  $q_s$  is estimated as shown in Table 9-2.

**Table 9-2 Radiation Inflow Data and Calculations**

Parameter	Symbol	Units	June	December
Median peak daily solar radiation (horizontal) <sup>(1)</sup>		W/m <sup>2</sup>	700	200
Ratio of inclined to horizontal radiation <sup>(1)</sup>		--	80%	160%
Average monthly temperature <sup>(2)</sup>	$T_{\text{month}}$	°F	61.7	8.5
Average daily high air temperature <sup>(2)</sup>	$T_{\text{air}}$	°F	74.2	18.1
Average dew point temperature <sup>(2)</sup>	$T_{\text{dp}}$	°F	51.1	6.8
Average wind speed <sup>(2)</sup>	$u$	mph	8.2	8.5
Calculated median peak daily solar radiation (inclined)	$q_s$	W/m <sup>2</sup>	560	320
Calculated effective sky temperature	$T_{\text{sky}}$	°F	277	248
Calculated long-wave radiation absorbed from atmosphere	$q_a$	W/m <sup>2</sup>	268	172

(1) Reference (34)

(2) Reference (35)

### 9.3.3.2 Atmospheric Radiation

For the purposes of these calculations, the pit wall is assumed to behave as a thermodynamic “grey body”, with infrared emittance and reflectance (a.k.a. albedo) that are not dependent on temperature or wavelength. The assumed emittance  $\varepsilon$  and reflectance  $\alpha_{\text{solar}}$  for the rock wall are shown along with other thermodynamic inputs in Table 9-1.

The long-wave radiation absorbed by the pit wall from the atmosphere can be estimated by treating the sky as a black-body radiator with an effective temperature  $T_{\text{sky}}$  [°K]:

$$T_{\text{sky}} = T_{\text{air}} \left[ 0.711 + 0.0056T_{\text{dp}} + 7.3 \times 10^{-5}T_{\text{dp}}^2 + \cos\left(\frac{2\pi t}{24}\right) \right]^{\frac{1}{4}} \quad \mathbf{9-3}$$

where  $T_{\text{air}}$  is in °K,  $T_{\text{dp}}$  is in °C and  $t$  is the hour past midnight. Using the temperature and dew point values measured at International Falls and shown in Table 9-2, the resulting calculated values for  $T_{\text{sky}}$  at noon are shown in Table 9-2.

Using the effective sky temperature, the long-wave radiation absorbed by the pit walls from the atmosphere is calculated from Equation 9-4, where  $\sigma$  is the Stefan-Boltzmann constant from Table 9-1. The resulting energy absorbed is shown in Table 9-2.

Date: February 13, 2015	NorthMet Project Waste Characterization Data Package
Version: 12	Page 112

$$q_a = \varepsilon\sigma T_{sky}^4 \quad 9-4$$

### 9.3.3.3 Reflected Solar Radiation

The solar radiation reflected by the pit wall is simply calculated as a fraction of the incoming solar radiation, represented by the reflectance  $\alpha_{solar}$ . The calculated values for  $q_r$  are shown in Table 9-3.

### 9.3.3.4 Emitted Radiation

The remaining elements of the energy balance (Equation 9-2) for the rock face are functions of the temperature at the surface of the rock and must be solved by iteration. Long-wave radiation emitted by the stone  $q_e$  is calculated using a similar equation to the long-wave radiation absorbed from the atmosphere:

$$q_e = \varepsilon\sigma T_{wall}^4 \quad 9-5$$

### 9.3.3.5 Convective Heat Transfer

Convective heat transfer away from the rock face by moving air can be estimated by assuming turbulent flow over a segment of the rock face, which acts as a long plate. The heat removed from the rock is a function of the temperature difference between the rock and the air and the convective heat transfer coefficient  $\bar{h}$ , which is a function of the properties of the moving air mass over the plate:

$$q_{conv} = \bar{h}(T_{wall} - T_{air}) \quad 9-6$$

$$\bar{h} = 0.0370 \left(\frac{uL}{\nu}\right)^{0.8} Pr^{0.43} \left(\frac{k_{air}}{L}\right) \quad 9-7$$

where  $u$  is the velocity of the flowing air [m/s],  $L$  is the assumed length of the wall face [m] and  $\nu$ ,  $Pr$  and  $k_{air}$  are thermodynamic properties of air at the “film temperature” midway between  $T_{wall}$  and  $T_{air}$  (assumed values shown in Table 9-1). Using the mean wind speed measured at International Falls (Table 9-2) and an assumed unbroken wall face length of 50 m, the resulting values for the heat transfer coefficient are shown in Table 9-3.

### 9.3.3.6 Heat Conducted into Wall

Precise calculation of the heat conducted into the stone wall is beyond the scope of this analysis. The heat flow into the mass of wall rock is driven by the temperature difference between the surface  $T_{wall}$  and the temperature at depth, which is assumed to equal the average monthly temperature  $T_{month}$ . This simplified system can be approximated as:

$$q_{cond} = \frac{k_{stone}}{d} (T_{wall} - T_{month}) \quad 9-8$$

where  $k_{stone}$  [W/mK] is the thermal conductivity of the rock (Table 9-1) and  $d$  [m] is the depth at which the temperature difference applies. It is assumed that temperatures within the rock return to approximately the average monthly temperatures at  $d$  of 0.5 meters (this assumption has been validated below).

### 9.3.3.7 Wall Surface Temperature Increase

The above discussion has shown that the variables on the left side of the energy balance shown in Equation 9-2 can be calculated directly and the variables on the right side can either be calculated directly ( $q_r$ ) or are functions of the surface temperature  $T_{wall}$ . By trial and error,  $T_{wall}$  can be determined such that the energy balance closes. The calculated values for  $T_{wall}$  and for the remaining portions of the energy balance are shown for June and December conditions in Table 9-3. Because of the simplifying and conservative assumptions used in this analysis, the estimated median peak wall surface temperature in June is higher than expected (45.3 °C or 113.5 °F during daily high temperatures of 74.2 °F).

**Table 9-3 Calculated Radiation Outflows and Temperature Changes**

Parameter	Symbol	Units	June	December
Reflected solar radiation	qr	W/m <sup>2</sup>	112	64
Convective heat transfer coefficient	$\bar{h}$	W/m <sup>2</sup> /K	7.3	7.5
Wall surface temperature	T <sub>wall</sub>	°C	45.3	5.3
Emitted long-wave radiation	qe	W/m <sup>2</sup>	466	272
Convective heat loss	qconv	W/m <sup>2</sup>	158	97
Conductive heat loss into wall	qcond	W/m <sup>2</sup>	92	59
Wall surface temperature increase	ΔT <sub>wall</sub>	°C	28.8	13.0
Average temperature increase over 2m depth	$\overline{T_{2m}}$	°C	2.05	0.93

The values shown in Table 9-3 for  $\Delta T_{wall}$  represent the temperature increase at the rock surface due to solar and long-wave radiative heating beyond the temperature increase driven by diurnal air temperature changes (i.e.,  $T_{wall} - T_{air}$ ). It is this wave of additional heating that will potentially cause increased chemical reactions in the south-facing pit walls. The influence of this large diurnal temperature variation is limited to surface layer of wall rock and will trigger a pulse of increased temperature that will move back into the rock mass while being dampened. By assuming sinusoidal daily temperature variation at the rock surface and an infinite mass of rock, the envelope (peak of each pulse) of observed rock temperatures above mean daily temperatures can be defined by:

$$T = \Delta T_{wall} \cdot e^{-x \sqrt{\frac{\omega}{2\alpha}}} \quad 9-9$$

where  $\Delta T_{wall}$  is the temperature amplitude at the surface [ $^{\circ}\text{K}$ ],  $x$  is distance into the rock face [m],  $\omega$  is the frequency of the temperature oscillation [1/day] and  $\alpha$  is the thermal diffusivity of stone (assumed values in Table 9-1).

Using the temperature variation envelope shown in Equation 9-9, the changes in wall rock temperature driven by oscillating radiative heating are shown in Figure 9-3. The effect of the temperature increase is minimal ( $< 1^{\circ}\text{C}$ ) at depths deeper than 0.5 meters into the rock walls, validating the assumed value of  $d$  used in Equation 9-8 above.

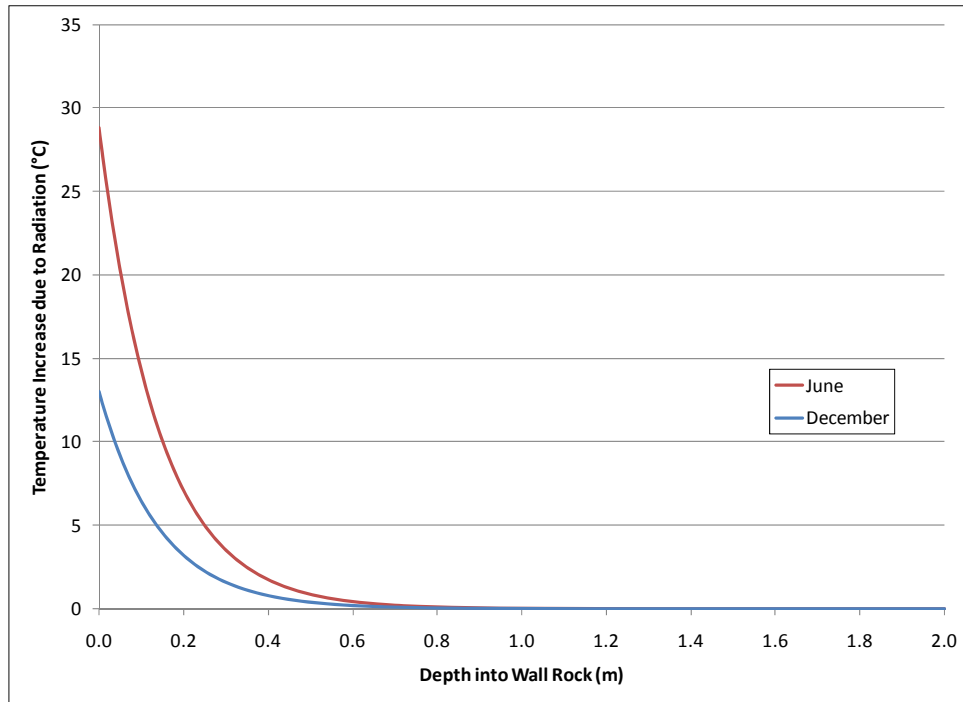

**Figure 9-3 Envelope of Increased Wall Rock Temperatures due to Radiation**

As discussed in Section 9.2, the geochemical modeling for the pit walls considers the reactive mass of wall rock to be, on average, 2 meters thick (all wall rock except Virginia Formation Category 4, Figure 9-1). The average temperature increase over the surface 2 meters of wall rock can be determined by integrating Equation 9-9. The resulting depth-averaged temperature values for June and December are shown in Table 9-3.

The values shown for  $\overline{T_{2m}}$  in Table 9-3 are assumed to represent the bounds of the annual temperature increase due to radiative heating. The average annual temperature increase over the 2 meter thickness of reactive rock (due to radiative heating) is then calculated to be  $1.5^{\circ}\text{C}$ . This temperature increase has been applied to the temperature used for lab-to-field





Date: February 13, 2015	NorthMet Project Waste Characterization Data Package
Version: 12	Page 115

scaling of the wall rock reaction rate (Section 8.1), but only for the south-facing portions of the pit walls (approximately 50% of both the West Pit and East Pit).

#### 9.4 Acidification and Long-Term Decay in Constituent Release

As discussed in Attachment A, data from the long-term MDNR tests on Duluth Complex rock provide information on the decrease in sulfate release following the onset of acidic conditions as readily-available sources of sulfide minerals are consumed. As discussed in Section 8.2.5, it has been suggested that the rapid decay observed in the MDNR reactors may over-state the potential decay under field conditions. Decay curves are developed here for both the MDNR reactors and the few NorthMet humidity cells that have exhibited decaying sulfate release. Note that this discussion focuses on acidification and declines after the onset of acidic conditions, and does not apply to Category 1 waste rock.

The modeled decay equation for sulfate release is of the form shown in Equation 9-10. This equation is distinct from a typical first-order decay equation in that it is a log-log relationship between release rate and time; time is not log-transformed in a typical first-order relationship. This log-log fit matches both the MDNR and NorthMet data better than a first order fit and results in a “flatter” long-term release curve. An example of the decay fit for one of the NorthMet humidity cells using Equation 9-10 is shown in Figure 9-4. Note that the value for time in Equation 9-10 is expressed in terms of weeks since the onset of acidic conditions, which has been determined as discussed in Section 8.2.5.

$$SO_4\left(\frac{mg}{kg \cdot week}\right) = 10^{a_1 \times \log time(weeks\ since\ peak) + a_0} \quad \mathbf{9-10}$$

The weekly humidity cell sulfate release data and the fitted decay curves for the NorthMet humidity cells used in this analysis are shown in Figure 9-5.

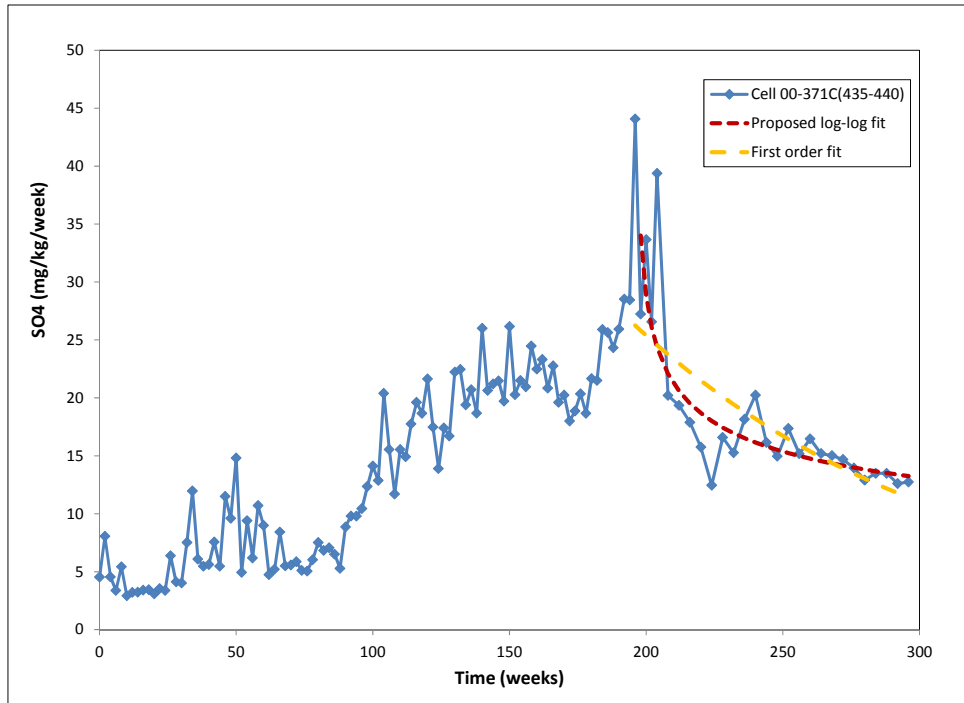

Figure 9-4 Example Sulfate Decay Relationships

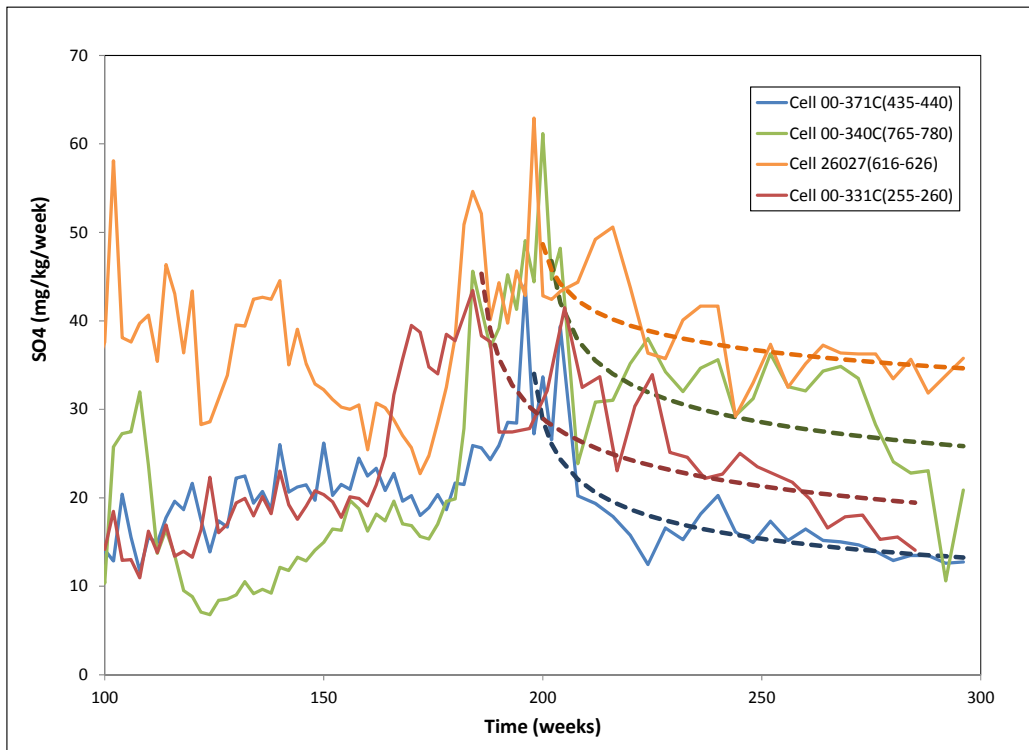
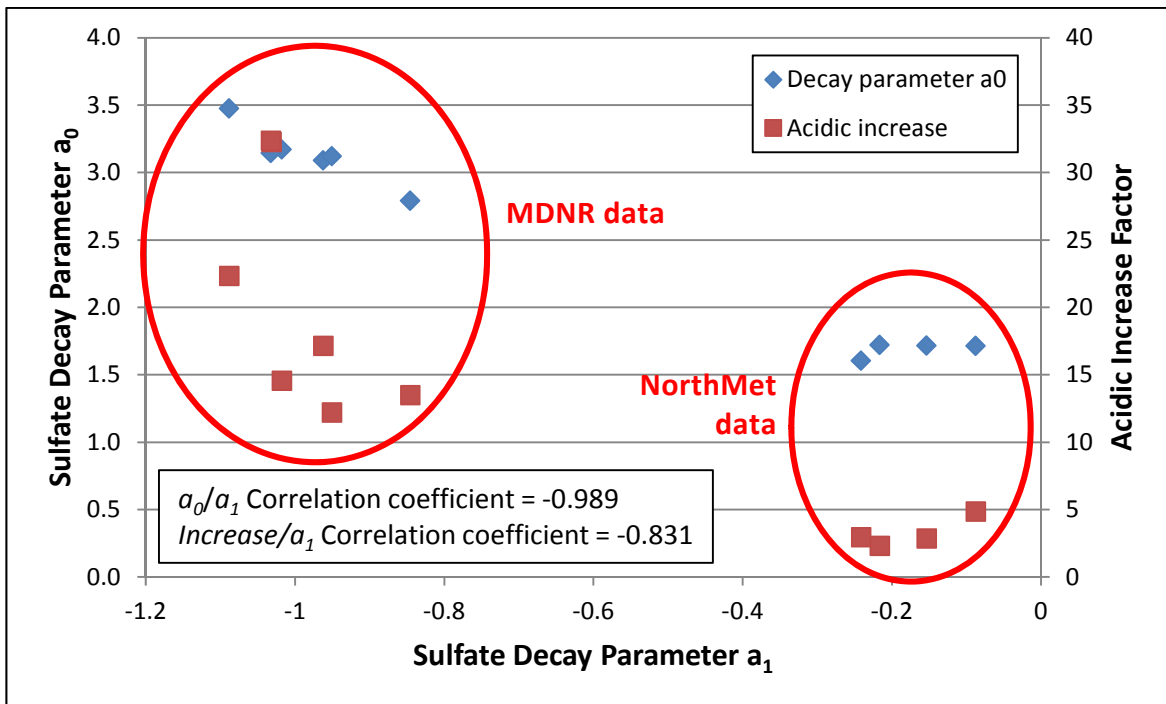

Figure 9-5 Sulfate Decay in NorthMet Humidity Cells

A plot of the parameters  $a_0$  and  $a_1$  developed from the MDNR long-term data and from the NorthMet humidity cell data are shown in Figure 9-6, along with the increase in sulfate release due to acidic conditions discussed in Section 8.2.5. See Table 3 of Attachment A for a list of the specific MDNR reactors used in this analysis; the NorthMet humidity cells used here are identified in Large Table 1. The parameters that describe the magnitude of the peak sulfate release ( $a_0$  and the increase over non-acid release) are highly correlated with the speed of the decay ( $a_1$ ). In both data sets test cells that have high initial acidic release rates (higher values for  $a_0$  and higher increase factors) experience the most rapid decay (lower, more negative values for  $a_1$ ). The correlation coefficient between  $a_0$  and  $a_1$  for the combined MDNR and NorthMet data is -0.989; the correlation coefficient between the acidic increase and  $a_1$  is -0.831 ( $\pm 1$  indicates perfect correlation, 0 indicates no correlation).



**Figure 9-6 Sulfate Decay Parameters from MDNR and NorthMet Data**

It is clear from Figure 9-6 that the MDNR reactors showed much greater decrease in sulfate release, as evidenced by lower, more negative values for the decay slope parameter  $a_1$ . This observation confirms the hypothesis that the finer material in the MDNR reactors likely overstates the decay in sulfate release that will be observed at field conditions. The decay relationships developed from the NorthMet humidity cells, in contrast, represent the cumulative impact on decaying release from a much wider range of particle sizes. Because of the uncertainty associated with the true long-term performance of the pit walls, the combined data is used to develop probability distributions.

Date: February 13, 2015	NorthMet Project Waste Characterization Data Package
Version: 12	Page 118

For the majority of the chemical constituents included in the probabilistic water quality modeling, release rates are simulated using ratios to sulfate release (Section 8.1.2). When the rock becomes acidic, sulfate release will increase by a factor as defined in Section 8.2.5 and the release of constituents simulated using ratios will increase accordingly. Similarly, long-term decay in release rates for all constituents is simulated by modeling decay in the sulfate release rate. When sulfate release declines according to Equation 9-10 the release of constituents simulated using ratios will decrease accordingly. No other decay rates have been calculated for other constituents in order to maintain the conceptual model of constituent release driven by sulfide oxidation. Those constituents with release rates not linked to sulfate are assumed to have no decrease in release rates.

Probability distributions for the parameters  $a_0$  and  $a_1$  developed from the combined test data are shown in Figure 9-8 and Figure 9-9. These uniform distributions represent the minimum and maximum parameter values observed in the referenced NorthMet humidity cells and MDNR reactors. The correlation coefficients developed from the combined MDNR and NorthMet data have been used to correlate these two distributions in the probabilistic modeling and to correlate decay to the increase in sulfate release from acidification (Section 8.2.5). These correlations in the modeling maintain the relationships observed in the laboratory: samples with high peaks in sulfate release also had rapid decay.

Unlike the waste rock stockpiles, the relatively thin veneer of wall rock is not expected to generate enough heat from chemical reactions to warm the wall rock above ambient temperatures (Section 9.3.3 for a complete discussion of wall rock temperature scaling). Therefore, the time to acidification determined from MDNR laboratory tests must be scaled to account for the slower rate of chemical reactions at field temperatures. The simulated time determined as in Section 8.2.5 has been divided by the temperature correction factor discussed in Section 9.3.3, effectively extending the period of nonacidic conditions.

The steps in modeling long-term sulfate release from wall rock are as follows:

- 1) Generate random nonacidic laboratory sulfate release rates (Section 8.1)
- 2) Generate random values for the time to onset of acidic conditions (Section 8.2.5)
- 3) Generate random scale-up correction factors for water contact, particle size, and temperature (Section 9.3)
- 4) Determine first date of wall rock exposure (Section 9.6.1)
- 5) If the time of wall rock exposure is less than the time to onset of acidic conditions divided by the temperature correction (to represent the longer time to reach peak release at field temperatures), sulfate release is nonacidic
  - a. Field sulfate release is calculated from nonacidic laboratory release rates times temperature and particle size corrections and partitioned between contact (flushed by runoff) and non-contact mass
- 6) If the time of wall rock exposure is equal to or greater than the time to onset of acidic conditions divided by the temperature correction (to represent the longer time to reach peak release at field temperatures):

- Generate random decay parameters  $a_1$ ,  $a_0$  (correlated to  $a_1$ ) and acidic increase factor (correlated to  $a_1$ )
- If the length of time the wall rock has been acidic is greater than zero, laboratory sulfate release is determined from Equation 9-10
- Field sulfate release is calculated from the result of Equation 9-10 times temperature and particle size corrections and partitioned between contact (flushed by runoff) and non-contact mass

As an example, twenty realizations of the modeling method described here are shown in Figure 9-7 for Category 2/3 wall rock. All other model parameters (nonacidic sulfate release rate, temperature correction factor, etc.) were held constant at their mean values and only the decay parameters  $a_1$  and  $a_0$  were allowed to vary according to the probability distributions shown in Figure 9-8 and Figure 9-9 and the defined correlation coefficient. The resulting range of sulfate release curves includes realizations with long-term sulfate release of more than five times the nonacidic release rate as well as realizations with significant and relatively rapid (within a few decades) decay to release rates below the pre-acidic value.

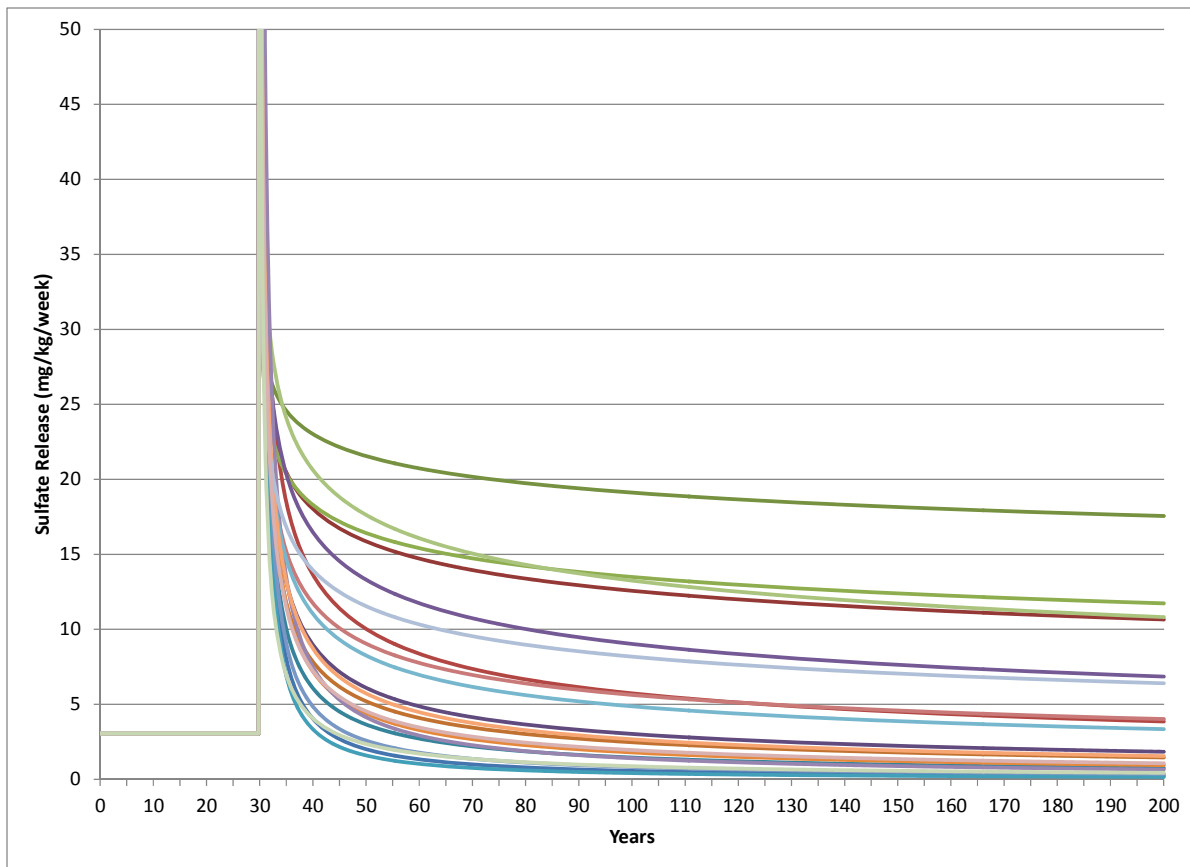

**Figure 9-7 Sulfate Decay Example Simulation (20 realizations)**

Long-term decay in release rates were not modeled for the Category 1 or for the Virginia Formation portions of the pit wall rock, only for the Duluth Complex Category 2/3, Category 4 and ore wall rock in both mine pits. The nonacidic reactions in the Category 1 wall rock are expected to consume the sulfide minerals too slowly for appreciable decay during the pit filling time, and there is no data on long-term behavior of this material similar to the MDNR reactors. In contrast, the different physical structure of the Virginia Formation wall rock has led to concerns of long-term physical weathering, which could liberate sulfide mineral grains for ongoing oxidation. Therefore it is conservatively assumed that there is no long-term decrease in sulfate release from the Virginia Formation portions of the pit walls.

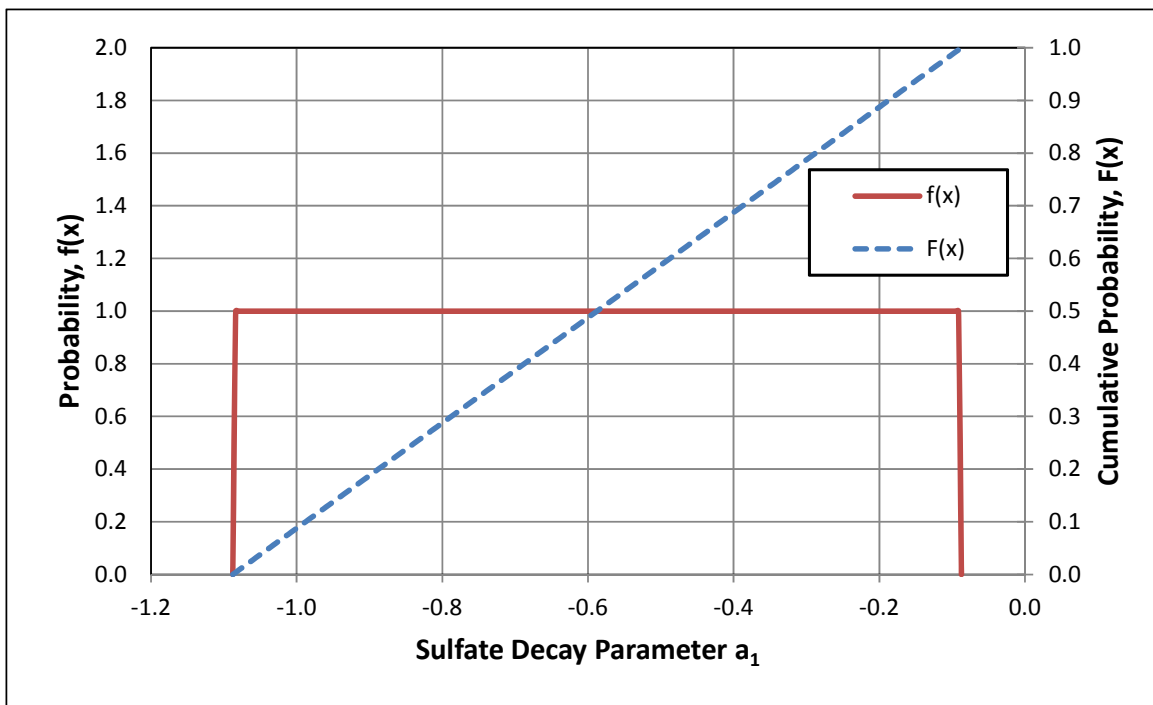

Figure 9-8 Distribution for Sulfate Decay Parameter  $a_1$

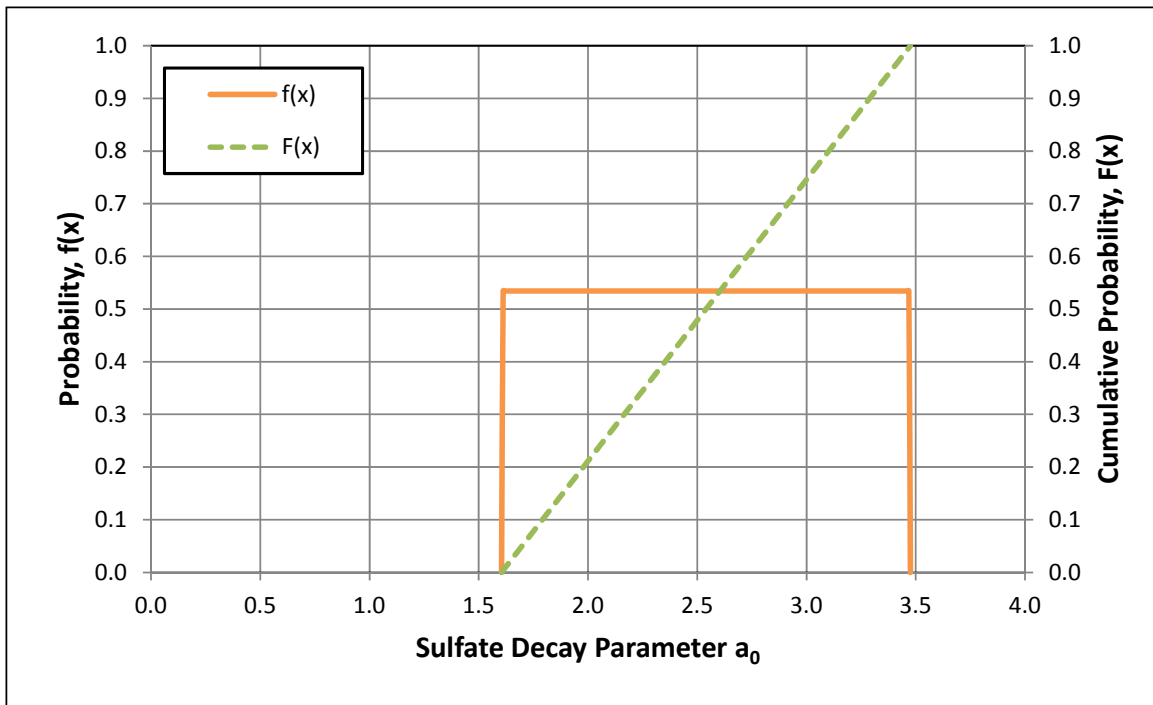

Figure 9-9 Distribution for Sulfate Decay Parameter  $a_0$

## 9.5 Concentration Caps

### 9.5.1 Pit Walls

Concentration caps for the water running off the pit wall rock are simulated using identical methods as for the waste rock stockpiles, described in Section 8.3. The simulated concentration caps are applied to the applicable portions of the pit walls by rock category.

As described in Section 9.1, the Virginia Formation highwall of the East Pit would be treated with limestone and capped with overburden and geomembrane in closure. The amount of limestone would be designed to provide sufficient buffering capacity to create neutral or near-neutral conditions along the wall rock, rather than the acidic conditions common for oxidizing Virginia Formation rock. In the probabilistic modeling, therefore, the concentration caps applied to that portion of the pit wall are those developed for the nonacidic Duluth Complex Category 2/3, Category 4 and ore rock. The geomembrane cap placed over the highwall would also have the effect of dramatically reducing the quantity of infiltrating water to contact the wall rock, making the concentration of the seepage water highly likely to reach the applied nonacidic concentration caps and limiting the pollutant mass transport away from the wall rock. The effect of this lower infiltration rate on lower mass transport, however, was conservatively not included in the probabilistic model.



Date: February 13, 2015	NorthMet Project Waste Characterization Data Package
Version: 12	Page 122

### **9.5.2 Pit Backfill and Pit Lake**

The waste rock and overburden material that is backfilled into the East Pit will be adjusted as needed to maintain circumneutral pH (see Section 2.2.1.1 of Reference (36)). The pH of the backfill porewater is not simulated directly. However, the concentration caps applied to the backfill porewater are those developed for the nonacidic Duluth Complex Category 2/3, Category 4 and ore rock. These nonacidic concentration caps are also applied to the water in the East Pit wetland, which will be in contact with submerged backfill material. The backfill pH control is assumed for the water quality modeling to not add any constituent mass to the East Pit.

For simplicity, the concentration caps developed for the Category 1 waste rock are applied to the West Pit lake to reflect the generally low acidity and metals content in the diluted pit water. This simplified empirical method, however, does not capture the complex geochemical processes in the aqueous system that will cause secondary mineral precipitation and impose solubility controls on some constituents in the pit water. If additional precision is needed for the long-term concentrations of the West Pit lake, a chemical and thermodynamic equilibrium model could be developed as part of permitting.

## **9.6 Additional Model Parameters and Considerations**

This section covers additional modeling parameters relating to pit wall rock and the pit lake.

### **9.6.1 Age of Pit Walls**

As mining progresses, the mine pit boundaries will be extended both vertically downward and horizontally through pushbacks. The typical age of the pit walls at any time will be dependent on the details of the Mine Plan. For the purposes of the probabilistic water quality modeling, all of the pit walls are assumed to be reactive at the commencement of operations (time zero). This assumption results in the over-estimation of loading to the WWTP during operations due to pit dewatering.

The Duluth Complex portions of the pit walls are estimated to become acidic in approximately 20 years (based on the time to acidity distributions presented in Section 8.2.5 and the temperature correction factor distribution presented in Section 9.3). The assumption that the pit walls are reactive at time zero minimizes the amount of nonacidic loading from the pit walls that is retained in the flooding pits during closure, effectively over-estimating the loading from the pit walls as the walls are inundated. This is especially true because the portions of the pit walls that will be exposed latest in mining (near the bottom of the pits) will be the first to be flooded and may not be exposed long enough to become acidic.

The sensitivity of the model results to this assumption will be evaluated during the modeling process to ensure that this assumption is in fact conservative.



Date: February 13, 2015	NorthMet Project Waste Characterization Data Package
Version: 12	Page 123

### 9.6.2 Backfill Modeling Parameters

The Mine Plan provides the quantity of waste rock (in tons) that is moved to the East Pit during each year of backfilling. In order to determine the volume of the pit occupied by the backfilled rock, the available pore space and the water required to maintain steady flooding of the backfill, the following parameters are used in the water quality model. These parameters are considered deterministic (known) and do not vary through time.

- waste rock specific gravity: 2.93
- waste rock swell (effective increase in bulk volume, including voids): 30%
- backfill porosity: 0.2255
- desired margin between backfill surface and water table: 5 feet (elevation)

### 9.6.3 Nitrogen in Mine Pits

As described in Section 8.4.2, standard methods can be used to estimate the quantity of nitrogen residues from explosives that are present on blasted waste rock and may potentially leach to the surrounding environment. For the mine pits, this information can be used to estimate the nitrogen leaching from the pit walls to the flooded pit lakes.

Because the West Pit is a source of water in post-closure to both the Partridge River via a surface overflow and to the surficial groundwater, a scoping-level analysis was prepared to compare potential West Pit water quality with both the surface and groundwater quality standards. This analysis uses the computed ammonia and nitrate plus nitrite loading per metric ton of waste rock shown in Table 8-10. The total mass of wall rock in the West Pit, assuming a conservatively-large thickness of 3 meters (high end of the range shown in Figure 9-1, is 10,730,000 metric tons. The total water volume in the flooded West Pit at overflow is 100,040,000 cubic meters.

The West Pit walls will be exposed to rainfall for at least several years during operations and could potentially leach most of the nitrogen while pit wall runoff and other inflows are collected and treated prior to pit flooding. The pit walls are assumed to leach half of the nitrogen during operations and half during flooding for this scoping-level analysis.

As a result of this analysis, the water quality in the West Pit at overflow is estimated as 0.17 mg/L nitrate plus nitrite (as N) and 0.021 mg/L ammonia (as N). The computed nitrate plus nitrite concentration is significantly less than the groundwater quality standard of 10 mg/L, while the ammonia concentration is approximately half of the surface water quality standard of 0.04 mg/L for un-ionized ammonia. Note that at the expected site temperatures and near-neutral pH of the flooded West Pit water, un-ionized ammonia will represent approximately 1% of the total ammonia in solution and the resulting concentration would be much less than the surface water quality standard. Note that this scoping-level analysis does not consider the

effects of biologic activity and the cycle of nitrogen uptake and denitrification. These effects would tend to reduce the amount of available nitrogen in the flooded pit lake.

The generally low availability of nitrogen in other mine pits in northeastern Minnesota supports the conclusion that exceedances of surface or groundwater standards for nitrogen is not a concern in the mine pits. See Table 9-4 for water quality data from 2008 and 2009 from flooded mine pits at the former LTVSMC mine for an example. Given these data and the analysis included here, the effects of explosives residue on water quality has not been included in the probabilistic model of the mine pits.

**Table 9-4 Nearby Pit Lake Nitrogen Concentrations**

Parameter	Units	Area 1 Pit (oldest)	Area 2 WX Pit (newest)	Area 6 Pit
Nitrate plus nitrite (as N)	mg/L	0.05	0.11	0.050
Ammonia (as N)	mg/L	0.116	0.05	0.050
pH	s.u.	8.35	8.53	8.31
Calculated un-ionized ammonia (as N) <sup>1</sup>	mg/L	0.003	0.002	0.001

Source: Reference (37)

(1) Calculated assuming site temperature of 3°C

#### 9.6.4 Subaqueous Oxidation

The modeling methodology for the pit lakes assumes that oxidation of sulfide minerals and the accompanying release of constituents is negligible when waste rock or pit walls are submerged under water. To test this assumption the rate of subaqueous oxidation can be calculated by an approach recommended by the MDNR and discussed in Reference (38). The original method is outlined in Reference (39).

The flux of dissolved oxygen ( $J$ , mg O<sub>2</sub>/m<sup>2</sup>/s) into a 1 m<sup>2</sup> column of tailings or waste rock can be estimated from the empirical equation:

$$J = 8.2 \times 10^{-2} DO \sqrt{\frac{(\phi - \phi^2)P}{d\tau}} \quad \text{9-11}$$

where  $DO$  is the dissolved oxygen concentration in the overlying water [mg/L],  $\phi$  is the rock porosity,  $P$  is the percentage of pyrite in the rock,  $d$  is the rock particle diameter [m], and  $\tau$  is the tortuosity of the oxygen flow path. The rate of pyrite consumption ( $CP$ , mg FeS<sub>2</sub>/m<sup>2</sup>/s) is estimated as:

$$CP = \alpha J$$

9-12

where  $\alpha$  is a factor based on the molar ratio of oxygen to pyrite in the oxidation of pyrite to ferric hydroxide, and is equal to 1.0.

The input values used for this analysis are shown in Table 9-5.

**Table 9-5 Scoping Model Inputs for Subaqueous Oxidation**

Parameter	Symbol	Units	Value	Notes
Dissolved oxygen	DO	mg/L	10	Typical surface water value
Wall rock porosity	$\phi$	--	0.1	Assumed value for fractured wall rock
Wall rock diameter	d	m	0.1	Median particle size of fractured rock
Wall rock tortuosity	$\tau$	--	3	Recommended value
Wall rock pyrite <sup>(1)</sup>	P	%	1.1	See note 1

(1) 1.1% pyrite is equivalent to a sulfur content of 0.6%, representing the high end of the Category 2/3 wall rock. The actual sulfide mineral in the NorthMet walls is pyrrhotite, not pyrite, but the difference is expected to be minimal for this calculation.

The resulting rate of pyrite consumption from Equation 9-12 is  $4.7 \times 10^{-6}$  mg FeS<sub>2</sub>/m<sup>2</sup>/s. This is equivalent to a sulfate release rate of  $3.9 \times 10^{-4}$  mg SO<sub>4</sub>/kg/week, assuming an average 2-meter thick column of wall rock (the calculated release is inversely related to the assumed wall thickness, so a smaller wall thickness is more conservative). For comparison, the average sulfate release rate for ore wall rock in the West Pit, as calculated from the release rate relationship in Figure 8-5 and the average particle size in Figure 9-2 (excluding the temperature correction), is 0.84 mg SO<sub>4</sub>/kg/week. The estimated sulfate release due to subaqueous oxidation, therefore, is more than three orders of magnitude less than the sulfate release from exposed wall rock.

For the pit walls, this calculation supports the assumption that subaqueous oxidation is a negligible contributor of sulfate and metals to the pit lake. For the West Pit, approximately 2% of the total pit wall surface area will remain exposed above the flooded elevation in post closure, representing more than enough rock mass to overwhelm any contribution from subaqueous wall rock. Furthermore, the assumed dissolved oxygen concentration of 10 mg/L is only applicable for the upper portions of the pit lake; the pit lake is expected to be thermally stratified for the majority of the year and below about 10 meters oxygen supply will be minimal.



Date: February 13, 2015	NorthMet Project Waste Characterization Data Package
Version: 12	Page 126

For the waste rock backfilled into the East Pit, the quantity of subaqueous waste rock is significant relative to the quantity of exposed wall rock. Once the backfill is complete and the pit is flooded, there will be approximately 1,000 times more rock mass submerged (backfill and pit walls) than exposed to the atmosphere. However, the oxygen supply to the waste rock backfill will be even more limited than in an open pit lake. The waste rock backfill will be covered with a layer of compacted soil to serve as a hydraulic barrier and a wetland will be constructed at the surface; there will be virtually no downward transport of atmospheric oxygen into the backfill. The only mechanism for oxygen transport into the backfill will be groundwater from bedrock, with typical concentrations around 3 mg/L and flow rates around 20 gpm for the entire pit. This small supply of oxygen will result in total sulfate release rates that are at least an order of magnitude less than those from the exposed wall rock.

### 9.6.5 Dewatered Material Oxidation

Concerns were raised in the NorthMet Impact Assessment Planning process regarding the potential for water quality impacts due to the oxidation of currently-saturated materials as the dewatering of the mine pits proceeds. When water is drawn out of the pores of surficial materials and bedrock as the water table is lowered, air will fill the void spaces and react with the exposed mineral soil surfaces. When dewatering ceases and the water table recovers, any oxidation products such as sulfate or soluble metals in the void spaces will be transported towards the pit lake by groundwater flowing into the cone of depression. The chemical loading from the dewatered materials could be a significant source of load to the flooded mine pits.

Given the information on current conditions and modeling of future conditions that is available at the Mine Site it is not possible to quantify the magnitude of the potential impacts to water quality from oxidation of the in-situ materials around the mine pits. This is because of a lack of information in several key areas:

- 1) Groundwater modeling: The MODFLOW model that has been developed to estimate pit inflows during dewatering and pit flooding does not provide realistic estimates of the size of the cone of depression around the mine pits. Without this information it is impossible to estimate the quantity of currently-saturated material that will have the potential to generate oxidation products.
- 2) Oxygen transport: In order to compute the mass of oxidation products released, the amount of oxygen reaching the newly-unsaturated material must be quantified. For this project, the waste rock stockpiles have been assumed to be fully oxygenated at all times. For the unsaturated tailings, an oxygen diffusion model has been constructed to simulate oxygen availability with depth through the moist tailings. The material surrounding the mine pits will be unsaturated but moist, and will not be fully oxygenated. Oxygen transport through the surficial material will be complicated by the presence of layered soils, perched saturated areas (especially in wetlands) and



Date: February 13, 2015	NorthMet Project Waste Characterization Data Package
Version: 12	Page 127

oxygen consumption by vegetation, biologic activity, decomposition and reaction with mineral soils (including sulfide minerals). There is not sufficient information about the conditions at the Mine Site to adequately simulate oxygen transport.

- 3) Material reactivity: In order for aerated mineral soils to oxidize to form sulfate and soluble metals, sulfide minerals such as pyrite and pyrrhotite must be present and in contact with the void spaces. The availability of these minerals will determine the rate at which oxygen is consumed oxidation products are formed. There is not sufficient information about the mineralogy in the saturated overburden to accurately determine the reactivity of the aerated soils.

While it is not possible at this time to estimate the impacts to water quality due to oxidation of dewatered material and subsequent reestablishment of the water table, it should be noted that any impacts will be a one-time occurrence and will primarily be to the pit lakes rather than to the surrounding environment. As water levels recover the groundwater flow gradient will be in to the pits, carrying any oxidation products into the flooding pit lakes. Once water levels are stable there will continue to be inward gradients towards the pits in many areas, particularly on the north sides of the pits. The areas with potential impacts to the surrounding environment will be limited to those locations where the final pit water level is above the top of the bedrock and groundwater flows away from the pit.

If the oxidation of dewatered in-situ material and subsequent reestablishment of the water table causes significant loading of sulfate or metals to the pit lakes during pit flooding, opportunities exist for mitigation through in-pit treatment or the Waste Water Treatment Facility, which will remain operational as needed in closure.



Date: February 13, 2015	NorthMet Project Waste Characterization Data Package
Version: 12	Page 128

## 10.0 Geochemical Parameters – Flotation Tailings

This section covers geochemical parameters relating to the Flotation Tailings and the underlying LTVSMC tailings that are used in water quality modeling.

### 10.1 Laboratory Release Rates

An updated methodology for interpreting the results of the NorthMet humidity cell tests is described in Section 5.1.3.2 and Large Table 5. This method builds on and continues the analysis presented in Attachment A. The specific methods used to develop probability distributions for the various constituents and types of tailings material are detailed here. The probability distributions discussed in this section are presented in Large Table 16 through Large Table 19 and shown in Large Figure 42 through Large Figure 60.

Separate methods for developing release rates are presented for the Flotation Tailings (coarse and fine) and the LTVSMC tailings. It is important to note that the tailings modeling methods described in Section 10.2.1 are used to estimate the oxidation of sulfide minerals and the subsequent release of sulfate. For this reason the remaining release ratios and solids ratios, as much as possible, must be linked to sulfate release.

#### 10.1.1 Flotation Tailings

The methods for modeling the uncertainty in laboratory-scale release rates for all constituents are described below. Distribution parameters used in the probabilistic modeling are shown in Large Table 16 and Large Table 17 and Large Figure 42 through Large Figure 49.

##### 10.1.1.1 Release Rates from Humidity Cells

For all constituents with release rate methods identified by “XX Rate” or “XX/XX Rate” in Large Table 5, probability distributions have been developed either directly from the humidity cell data (SO<sub>4</sub>) or the ratio of release rates in the NorthMet humidity cells (all others). For each cell a temporal average release rate or release rate ratio has been determined for the long-term average conditions. Humidity cells with material larger than the #200 mesh, previously referred to as “mid” (#100 mesh to #200 mesh) and “coarse” (larger than the #200 mesh) tailings separately, have been analyzed together to represent coarse tailings as determined from the tailings deposition study (Large Table 4 and Section 5.1.3.1). In all cases, only tailings samples generated when the pilot plant was adding copper sulfate have been included in this analysis. For manganese, the correlation to nickel release is much stronger in the tailings humidity cell data than in the waste rock data, therefore the Mn/Ni ratio is used to estimate tailings Mn release (waste rock modeling uses the Mn/SO<sub>4</sub> ratio).

A probability distribution has been fit to the sample data set of average release rates or release rate ratios (one per humidity cell) applicable for the specific tailings portion. The complete range of release rates observed in the humidity cell testing has been assumed to



Date: February 13, 2015	NorthMet Project Waste Characterization Data Package
Version: 12	Page 129

represent the possible average release rate from the entire mass of NorthMet coarse or fine tailings. No attempt has been made to weight the humidity cell data by sulfur content or otherwise bias the determined release rates towards the expected average conditions in the field.

For sulfate, the observed release rate in the humidity cell tests varies as a function of the remaining sulfur content, with observed release rates declining over time in the tests (see Attachment F). Because the oxygen transport modeling requires a zero-order reaction rate (see Section 10.3), a sulfate release rate that does not change with time or sulfur content must be defined. The humidity cell data were analyzed to compare the sulfate release rate (mg/kg/week) and the computed remaining sulfur content (%S) for each humidity cell, excluding the initial five weeks of testing as directed by the Co-lead Agencies to remove the effects of initial flushing of stored oxidation products. Linear regression was used on these data to estimate the effective sulfate release at the initial measured sulfur content for each humidity cell test. Based on this analysis there are no observed differences between the relationship of sulfate release and sulfur content for the various pilot plant tests. The distributions for sulfate release (fine and coarse tailings separately) have been defined from these initial effective sulfate release rates rather than an average observed release rate.

For all constituents with release rates determined from release ratios, the actual release rate for the constituent is calculated by multiplying the randomly-selected release rate ratio by the simulated release rate of the constituent in the denominator (ex. Mg release rate = Mg/SO<sub>4</sub> release ratio x SO<sub>4</sub> release rate).

For several constituents (Cd, Co, Zn) the proposed release rate ratios are derived from the Category 2/3 waste rock humidity cell tests rather than the tailings humidity cell tests. Similar to the proposed waste rock modeling method, release of these particular metals is observed to be strongly correlated to metal and sulfate release rates in the tailings humidity cells (not the solid metal to sulfur ratio, Attachment A). Due to the larger number of waste rock humidity cells, the waste rock data provides a better understanding of the possible range of variability in these release ratios than do the blended tailings humidity cell samples, therefore the distributions are fit to waste rock humidity cell data. The derived ratios are related ultimately to sulfate release, so the final release rates for these constituents are different than for the waste rock because of the different sulfate release rate.

#### **10.1.1.2 Release Rates from Solid Ratios**

For all constituents with release rate methods identified by “XX/XX” and data sources of “Aqua Regia” or “Microprobe” in Large Table 5, probability distributions have been developed from the solids content data in the NorthMet whole tailings testing database. For each constituent, a probability distribution for the solids ratio (ex. ratio of Cu/S in the whole tailings analysis) has been fit to the population of observed solids ratios applicable for the specific tailings portion.

For constituents with “Aqua Regia” identified as the source data, the solids ratios from analysis of the humidity cell samples have been used to develop distributions. As discussed above for the humidity cell release rates, the complete range of solids ratios observed in the whole tailings testing (for coarse and fine tailings separately) has been conservatively assumed to represent the possible average release rate ratio from the entire Flotation Tailings deposit, with no weighting or relationship to sulfur content.

For constituents with “Microprobe” identified as the source data, the solids ratios identified from analysis of individual mineral grains in the waste rock humidity cell tests have been used to develop distributions. Because the minerals present in the Flotation Tailings are the same as those in the NorthMet waste rock, the distributions used here are identical to those developed for the waste rock analysis. Again, the range of solids ratios in the microprobe testing has been assumed to represent the possible average conditions for the entire Flotation Tailings deposit.

The actual release rate for each constituent is calculated by multiplying the randomly-selected solids ratio by the simulated release rate of the constituent in the denominator (ex. Cu release rate = Cu/S ratio x SO<sub>4</sub> release rate in terms of S).

### 10.1.1.3 Release from Concentration Caps

For all constituents with release rate data sources identified by “Solubility Model” or “Defined Concentration Cap” in Large Table 5, release is not simulated directly in the probabilistic model. Rather, these constituents are assumed to be released so that concentrations are always at the indicated concentration caps. For alkalinity, the concentration cap is calculated based on modeled calcite solubility at a range of CO<sub>2</sub> partial pressures and the resulting pH conditions (Equation 10-1). For fluoride, the concentration cap is calculated based on calcium concentrations as determined for the Category 1 waste rock in Section 8.3.1, reproduced as Equation 10-2 (Reference (27)). For boron and chromium, the concentration cap is modeled as the concentration cap derived for the Category 1 waste rock, as described in Section 10.4.

$$\text{Alkalinity:} \quad \text{Alkalinity} \left( \frac{\text{mg}}{\text{L}} \right) = 0.110 + 2.42 \left[ C_a \left( \frac{\text{mg}}{\text{L}} \right) \right] \quad 10-1$$

$$\text{Fluoride:} \quad F \left( \frac{\text{mol}}{\text{L}} \right) = \sqrt{\frac{8.91 \times 10^{-11} \left( \frac{\text{mol}^3}{\text{kg}^3} \right)}{C_{a \text{ limit}} \left( \frac{\text{mol}}{\text{L}} \right)}} \times \left[ \rho_{\text{water}} \left( \frac{\text{kg}}{\text{L}} \right) \right]^{1.5} \quad 10-2$$

### 10.1.2 LTVSMC Tailings

The methods for modeling the uncertainty in laboratory-scale release rates for all constituents are described below. Distribution parameters used in the probabilistic modeling



are shown in Large Table 18 and Large Table 19 and Large Figure 50 through Large Figure 60.

### 10.1.2.1 Release Rates

For all constituents with release rate data sources identified as “HCT”, “Aqua Regia”, or “Microprobe” in Large Table 5, distributions for release rates and solids ratios have been determined as discussed above for the Flotation Tailings. All tailings humidity cell and whole tailings data used are for the LTVSMC tailings only, and include more whole tailings samples than those used in the humidity cells.

### 10.1.2.2 Release from Concentration Caps

For all constituents with release rate data sources identified as “Solubility Model” or “Observed Seepage” in Large Table 5, release is not simulated directly in the probabilistic model. Rather, these constituents are assumed to be released so that concentrations are always at the indicated concentration caps.

For constituents with identified controlling minerals, a solubility model has been developed to define the concentration of the seepage from the LTVSMC tailings material, as shown in Equations 10-3 through 10-5 (for fluoride, Reference (27)). For constituents where the controlling minerals are not well-defined, surrogate concentration caps have been developed from the seepage data collected at the existing LTVSMC basin. The inherent assumption of this method is that for many constituents, conditions in the existing LTVSMC basin represent capped conditions that are expected to continue in the future.

$$\text{Alkalinity:} \quad \text{Alkalinity} \left( \frac{mg}{L} \right) = 0.110 + 2.42 \left[ Ca \left( \frac{mg}{L} \right) \right] \quad 10-3$$

$$\text{Barium:} \quad \log \left[ Ba \left( \frac{mg}{L} \right) \right] = -0.32 \times \log \left[ SO_4 \left( \frac{mg}{L} \right) \right] - 0.87 \quad 10-4$$

$$\text{Fluoride:} \quad F \left( \frac{mol}{L} \right) = \sqrt{\frac{8.91 \times 10^{-11} \left( \frac{mol^3}{kg^3} \right)}{Ca_{limit} \left( \frac{mol}{L} \right)}} \times \left[ \rho_{water} \left( \frac{kg}{L} \right) \right]^{1.5} \quad 10-5$$

As discussed in more detail in Section 10.5, the modeling of the FTB assumes no geochemical interaction between the NorthMet and LTVSMC tailings or their seepage water. The application of solubility controls or defined seepage concentrations (rather than generation rates) for the LTVSMC tailings as discussed here is therefore not used to limit the loading originating from the FTB. Chemical loading from the LTVSMC tailings, whether determined from laboratory generation rates or observed seepage concentrations, is additive to the loading from the Flotation Tailings (i.e., the estimated concentration at the toe of the

Date: February 13, 2015	NorthMet Project Waste Characterization Data Package
Version: 12	Page 132

existing LTVSMC tailings is allowed to be higher than the defined seepage concentration from the LTVSMC tailings alone).

### 10.1.2.3 Flushing Load

As in previous modeling of the FTB, the probabilistic model includes loading from the flushing of soluble metals when LTVSMC tailings are disturbed to construct the dams. Leaching of soluble metals is assumed to occur in the first year after construction of each lift of the dam. Distributions for the mass loading of all constituents (per mass of disturbed tailings) have been derived from the leach extraction tests on LTVSMC tailings material and are shown in Large Table 19 and Large Figure 56 through Large Figure 60.

## 10.2 Lab to Field Scale Up

The scale-up method from laboratory release rates to field release rates is very similar to the method used for the waste rock described in Section 8.2. In that section, the scaling factor for waste rock is dependent on differences in temperature, particle size and water contact. The tailings however use a correction factor for temperature and an additional factor for freezing. The tailings used in the humidity cells are the same size as the operational tailings so there is no need to correct for differences in particle size. Additionally, the vertical flow behavior through the tailings will be different from that through a stockpile of waste rock. Water will likely not create highly preferential flow in the tailings meaning the water contact at both field and lab scales will be about the same. Therefore, the scaling factor is only dependent on temperature differences and times of the year when the tailings are frozen.

The scale-up factor equation from Section 8.2 (Equation 8-9) is modified to include only the temperature factor and freezing factor:

$$S = k_T * (1 - k_f) \quad 10-6$$

The method for calculating  $k_T$  is described in detail in Section 8.2.4. Figure 10-1 shows the resulting distribution for  $k_T$ . The temperature data described in Section 8.2.4 was used to determine the portion of the year that temperatures are below freezing. For this analysis, the daily maximum temperature was used and a count was made of days where the maximum temperature was below freezing for each year (1981-2010). The year with the minimum number of days below freezing was 1987 with 73 days (2.4 months). The year with the maximum number of days below freezing was 1996 with 133 days (4.4 months). The average number of days below freezing was 102.8 days or 3.4 months. A triangular distribution was chosen to represent the frozen period, with a minimum of 2.4 months ( $k_f = 0.2$ ), a mode of 3.4 months ( $k_f = 0.283$ ), and a maximum of 4.4 months ( $k_f = 0.367$ ). Figure 10-2 shows the input distribution for  $k_f$  and Figure 10-3 shows the resulting composite scale factor,  $S$ .

In the water quality modeling, the randomly generated laboratory release rate of sulfate is multiplied by the scale-up factor to produce the field-scale release rate of sulfate. This scaling applies to both the Flotation Tailings and the LTVSMC tailings.

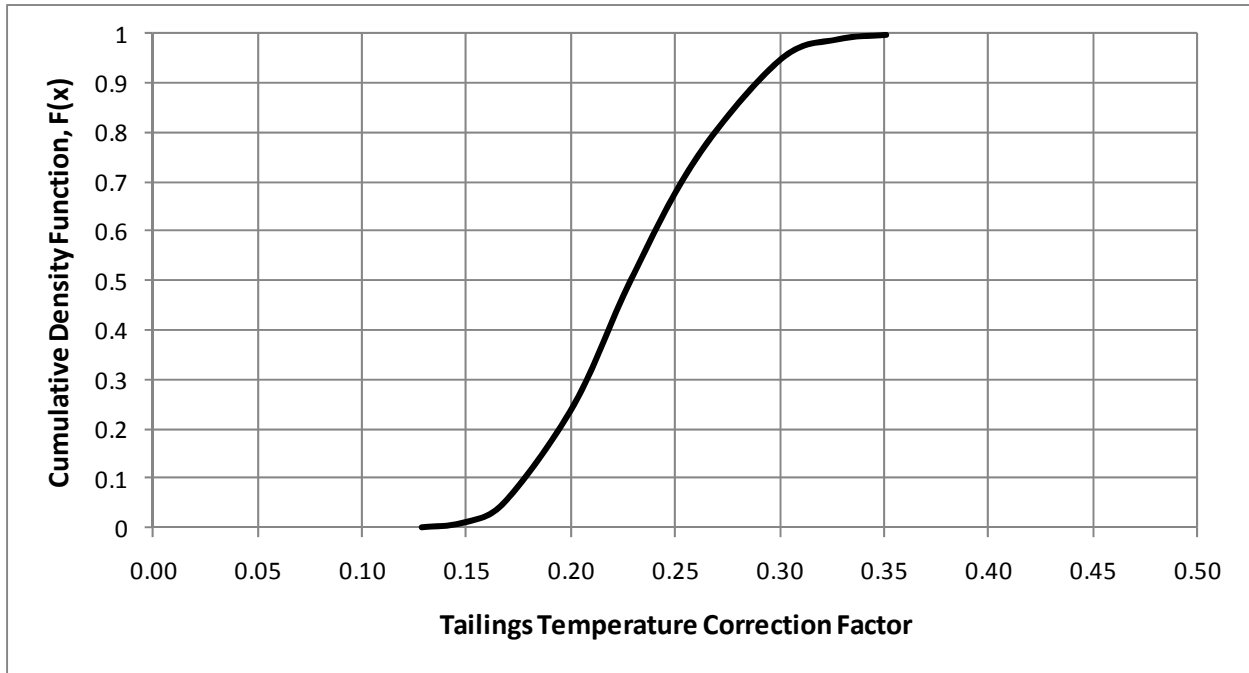

Figure 10-1 Distribution for the Tailings Lab-to-Field Temperature Factor

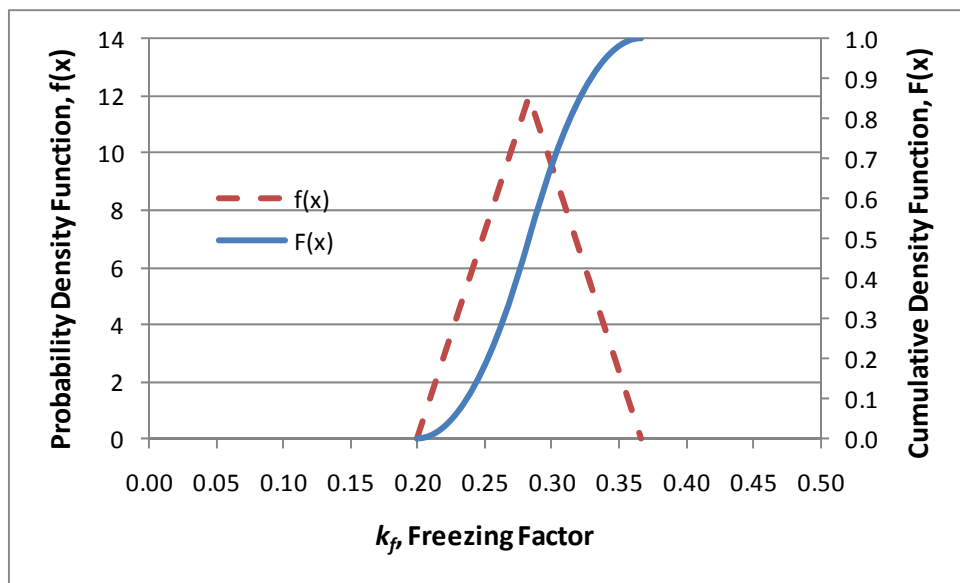
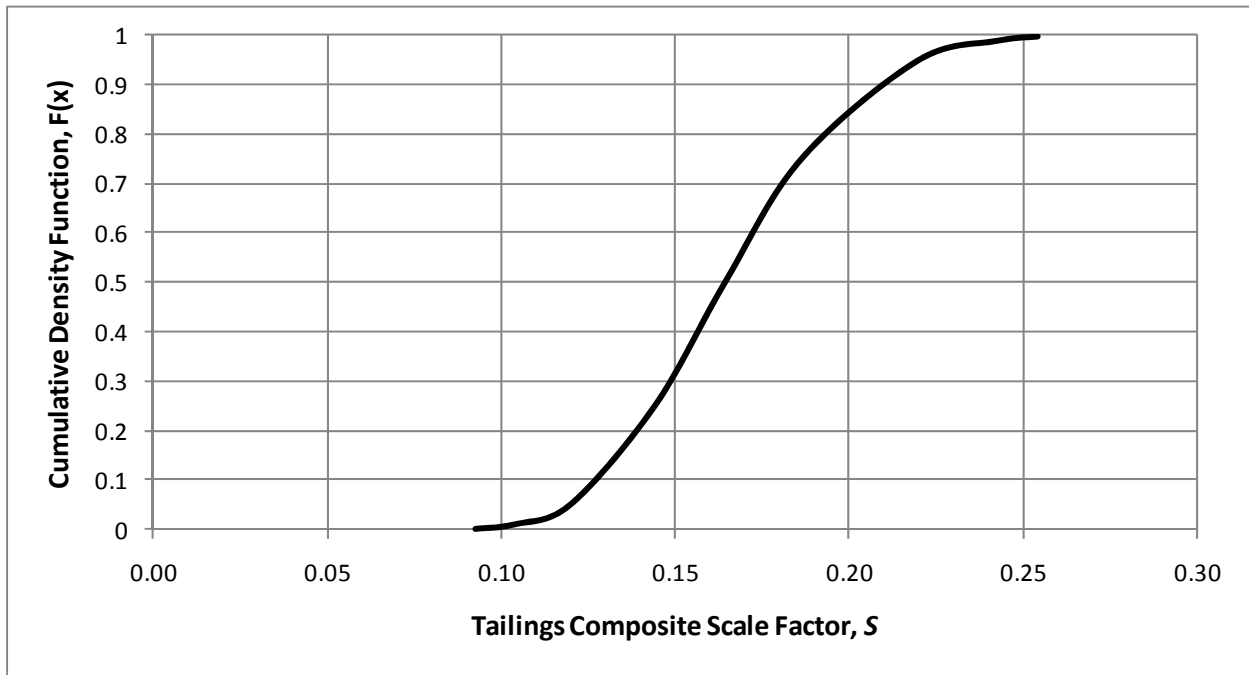

Figure 10-2 Distribution for the Tailings Lab-to-Field Freezing Factor



**Figure 10-3 Distribution for the Tailings Composite Lab-to-Field Scale Factor**

### 10.2.1 Scaling / Calibration to LTVSMC Field Data

Loading from the Tailings Basin was not modeled for the DEIS. The basin however is included in the modeling for the SDEIS and FEIS. Laboratory release rates from the LTVSMC tailings for sulfate and laboratory release ratios for other constituents are described in detail in Section 10.1.2. There is also existing field data characterizing the quality of the seepage from the existing basin. This section discusses the methods used to modify the laboratory release rates and ratios so that the estimates of the existing conditions model of the Plant Site reasonably reflect the current field conditions at the Plant Site.

Section 10.3 and Section 10.6.1 describe the method by which constituent load is generated within the LTVSMC tailings. Section 5.4.5 of Reference (40) describes the MODFLOW model of the existing Plant Site that is used to describe the existing flow condition (seepage rates, transport direction, etc.). These sections in combination describe the rate at which the generated load within the existing basin and the seepage load from the existing ponds reports to each toe of the Tailings Basin. Furthermore, the total seepage rates and the total loading rates at each toe are used to determine the concentration leaving the basin at each toe for each constituent.

Because the release rates for all constituents are dependent on the sulfate release rate, it is very important to properly capture the sulfate release rate for the different classes of existing LTVSMC tailings. Large Table 18 shows that there is one distribution for the sulfate release



Date: February 13, 2015	NorthMet Project Waste Characterization Data Package
Version: 12	Page 135

rate for LTVSMC tailings; it does not differentiate by size fraction (i.e., coarse or fine). An existing conditions model was created to determine the loading from the existing LTVSMC basin using the theoretical model described in Section 10.3 and Section 10.6.1.

Several of the wells around the Tailings Basin were chosen to be representative of seepage at each toe of the basin. See Large Figure 5 of Reference (40) for locations of the wells and surface seeps used. See Large Figure 6 of Reference (40) for the delineation of the toes of the basin (e.g., the north toe flows into the north flow path). Water quality data from monitoring locations GW001, GW006, GW007, GW012, SD004, SD026, and PM-7 (another identifier for SD026) were used to establish concentration targets for the GoldSim model calibration. Compared with other monitoring locations, observed concentrations at these locations are relatively similar to those observed at monitoring well GW005, which is completed within the footprint of the Tailings Basin. Based on data collected at GW005, Tailings Basin pore water is characterized by elevated concentrations of total dissolved solids (especially chloride, sulfate, and other major cations and anions). Tailings Basin pore water at GW005 also contains higher concentrations of trace constituents such as molybdenum and fluoride. Monitoring wells GW001, GW006, GW007, and GW012 are completed at the toe of the Tailings Basin and generally exhibit elevated concentrations of constituents characteristic of Tailings Basin pore water. In addition to the water quality at SD004, SD026, and PM-7, which is similar to the Tailings Basin pore water, the physical locations of these monitoring locations allows for minimal influence from the natural environment. Water at SD004 discharges from a steel pipe that emerges from the toe of the Tailings Basin; therefore, it is unlikely that significant dilution from un-impacted water would occur. SD026 is located just downstream of an area where water is observed to be seeping directly out of the Tailings Basin, with minimal potential for dilution. Therefore, as shown in Table 10-1, GW001 and GW012 are used to represent the seepage to the north toe, GW006 is used to represent the seepage to the northwest toe, GW007 and SD004 are used to represent seepage to the west toe, and SD026 and PM-7 are used to represent seepage to the south toe.

The average concentration was used as the target seepage concentration. Table 10-1 shows the four toes of the basin, the sampling locations chosen to represent the basin seepage, and the average concentration of the samples at those locations. The seepage rate from the basin at each toe is determined by summing the infiltration rates throughout the basin and the pond seepage rates, assuming that there is no storage (i.e., steady-state). Mean values were used for all model inputs (i.e., infiltration rates, air temperature, freezing factor, etc.).

The total load leaving the Tailings Basin does not come entirely from oxidizing tailings. A portion of the load comes directly from the seepage from the ponds in Cells 1E and 2E. This load is accounted for by using an average pond SO<sub>4</sub> concentration (sampling in 2001-2004) and constant pond seepage rates determined by the calibrated MODFLOW model (Section 5.4.5 of Reference (40)). The seepage rate and sulfate concentration from the pond in Cell 2E to the basin toes is approximately 580 gpm and 130 mg/L respectively. The seepage rate and sulfate concentration from the pond in Cell 1E to the basin toes is

approximately 900 gpm and 95 mg/L respectively. Using the total load leaving the basin from Table 10-1 (4150 kg/day), and the total load seeping from the existing ponds (880 kg/day), the tailings are generating a load of about 3270 kg/day due to oxidation.

**Table 10-1 Input values for the target concentrations and loading from the basin**

Basin Toe	Sampling Locations	Average SO <sub>4</sub> Seepage Concentration (mg/L)	Number of Samples	Approximate Seepage Rate (gpm)	Average Loading Rate (kg/day)
North	GW001, GW012	224	30	1540	1880
North-West	GW006	505	18	440	1210
West	GW007, SD004	251	42	610	835
South	SD026	181	113	230	225

The results from the existing conditions model showed a significant over-estimation of sulfate concentrations, reflecting the large degree of conservatism already built into the model assumptions (Figure 10-4). The red stars are the model's estimation of seepage concentrations. The bars show the minimum, average, and maximum of the sampled concentrations at each toe.

Therefore, two sulfate release rate correction factors are suggested, one for each of the two different LTVSMC tailings classes (coarse and fine). Modeling the LTVSMC tailings as separate coarse and fine fractions is a similar method to that proposed for the Flotation Tailings in Section 10.1.1. The sulfate correction factors are applied to the generic LTVSMC tailings sulfate release rate, creating two new calibrated sulfate release rates; one for the coarse LTVSMC tailings and one for the fine LTVSMC tailings (the dams of the existing basin are assumed to be constructed with coarse tailings). These factors alter the laboratory sulfate release rate so that the estimated sulfate concentrations at the toes of the existing basin are much closer to the concentrations seen in the current field data.

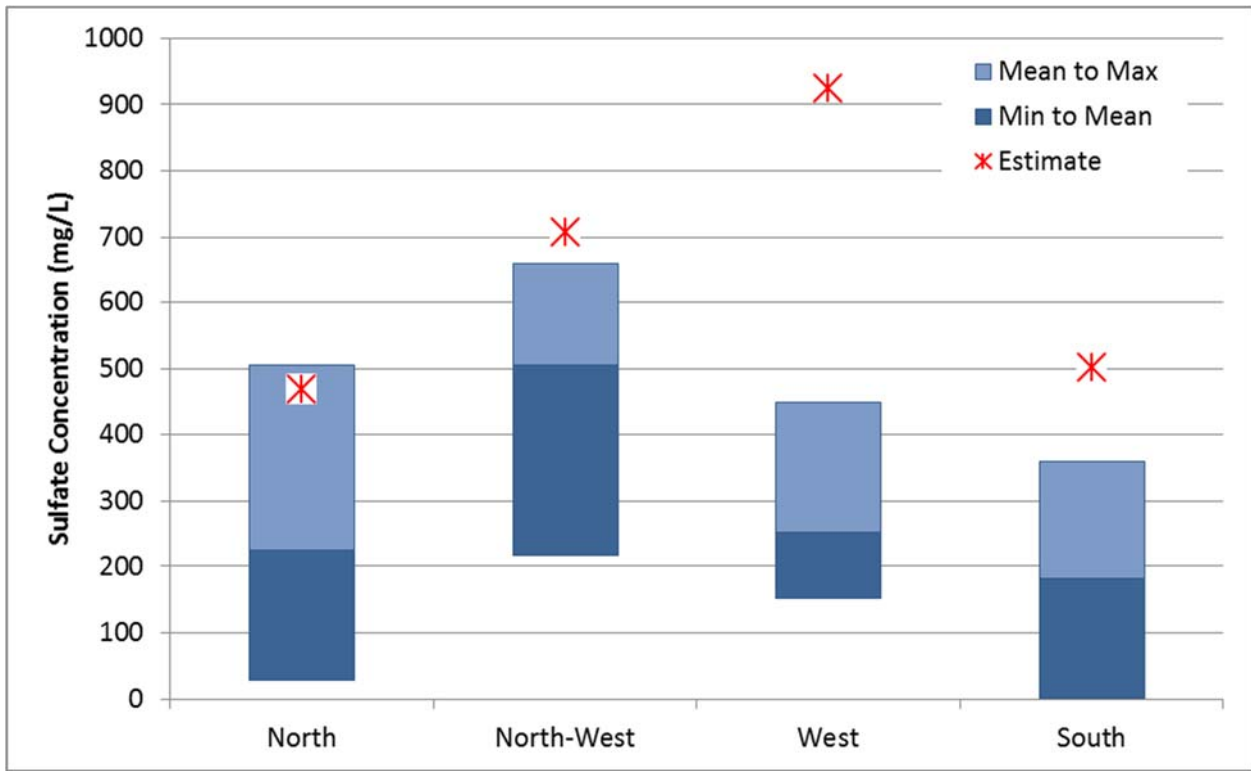

**Figure 10-4 Sulfate concentrations of the un-calibrated existing conditions model**

To constrain the calibration, the total modeled load leaving the basin using mean values for all inputs was set equal to the total sampled load leaving the basin (Equation 10-7).

$$\left[ \sum_{i=1}^4 \bar{C}_i \bar{Q}_i \right]_{Field} = \left[ \sum_{j=1}^4 \bar{C}_j \bar{Q}_j \right]_{Model} \quad 10-7$$

Due to this constraint, one of the calibration factors becomes a function of the other (fine tailings factor is a function of the coarse tailings factor). In other words, because the total load is fixed, if one calibration parameter increases, the other must decrease to maintain the fixed total load. Therefore, only one parameter was adjusted (coarse tailings factor) to minimize the calibration objective function (Equation 10-8).

$$\max [abs(\bar{C}_{i,Field} - \bar{C}_{i,Model}) * Q_i] \quad 10-8$$

Equation 10-8 is simply the greatest loading error between samples and model estimates at the toes. The coarse tailings calibration factor was adjusted and the fine tailings calibration factor was held as a function of the coarse tailings factor. The values that gave the best results were 0.2 and 0.7 for the coarse and fine factors respectively. When the LTVSMC

tailings release rates are multiplied by these factors, the model estimates are much closer to the sampled data (Figure 10-5).

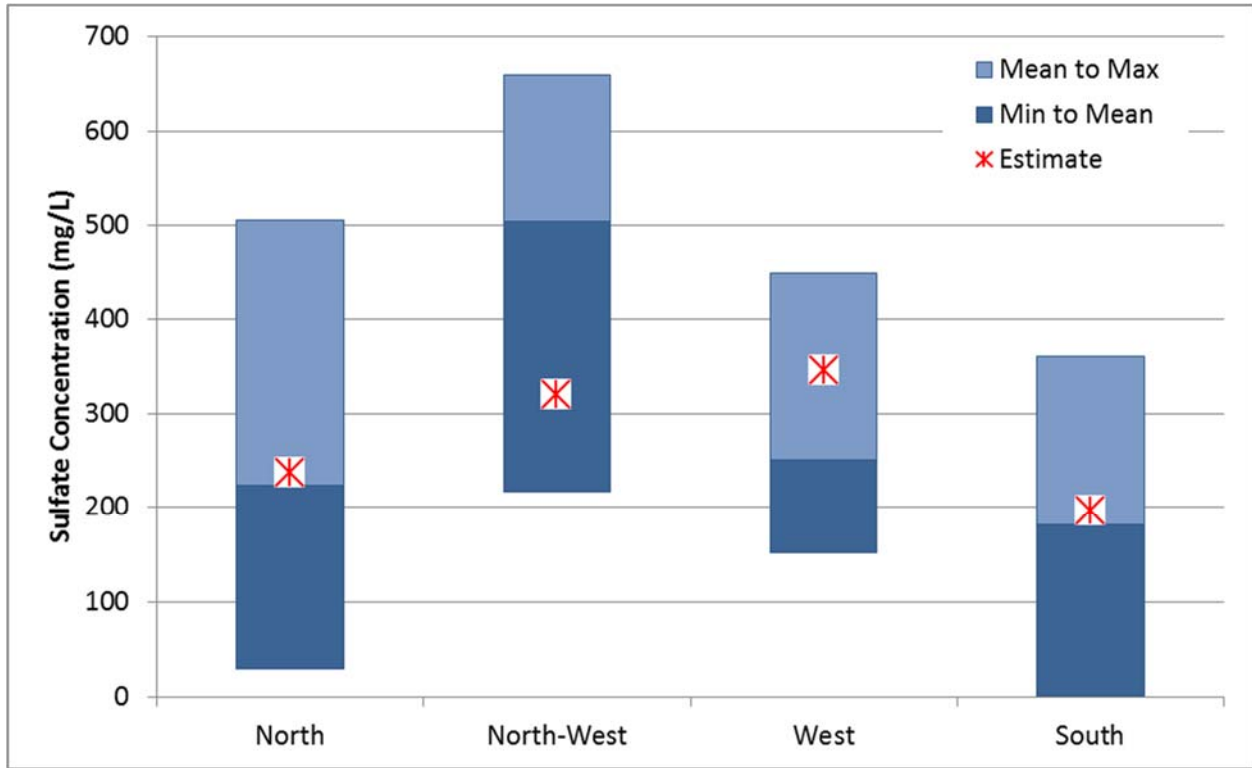
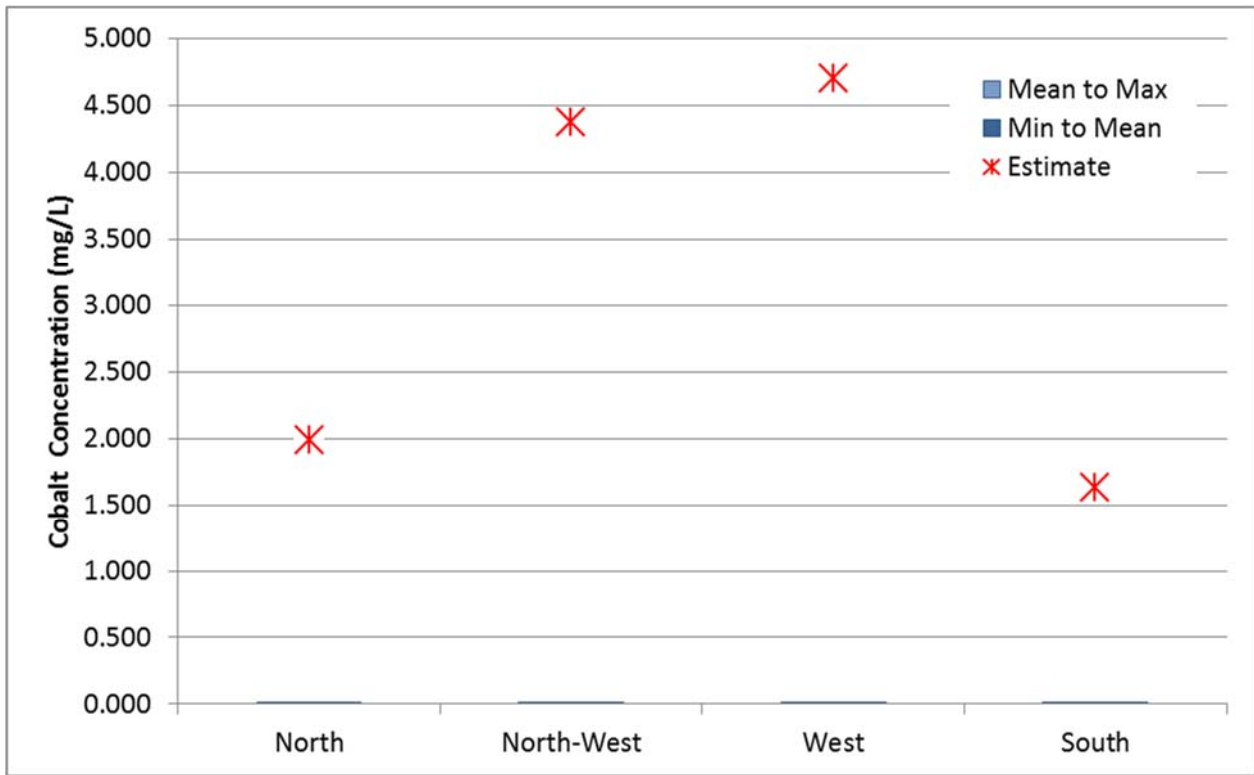

**Figure 10-5 Sulfate concentrations of the calibrated existing conditions model**

As seen in Figure 10-5, the estimates of the sulfate concentrations at the north and south toes are close to the average sampled in the field. The northwest and west estimates tend to underestimate and over-estimate the means. However, due to the constraint of Equation 10-7, the total load leaving the Tailings Basin is equal to the average load expected from sampling data. Even though the calibrated model estimates are not perfect, it is clear that calibration factors are needed so that the model reflects the sampled data. Without these calibration factors, the model would simulate more than twice the load that the sampling data suggests is generated.

The existing conditions model was also used to test model estimates of all other model constituents (Cu, Ni, etc.) against field data. Figure 10-6 shows the model estimates using the laboratory release ratio of Co to S (0.041 mg Co / mg S).





**Figure 10-6 Cobalt concentrations of the un-calibrated existing conditions model**

Even while using calibrated sulfate release rates, the model over-estimated concentrations of all other constituents, indicating that the metal release ratio for each constituent is also conservatively high. Therefore, an additional constituent-specific correction factor is suggested to be applied to the release ratios. The suggested correction factor alters the release ratio of each constituent so that the concentrations at the toe of the basin in the existing conditions model are reasonably close to the observed field water quality data. For this calibration though, there is only one parameter. Therefore, Equation 10-7 determines this parameter and Equation 10-8 is not used for the calibration of release ratios of constituents other than sulfate. For cobalt, the calibration factor is 0.0005, making the overall release ratio  $2.05 \times 10^{-5}$  mg Co / mg S. Figure 10-7 shows the model results when the calibration factor is used for cobalt.

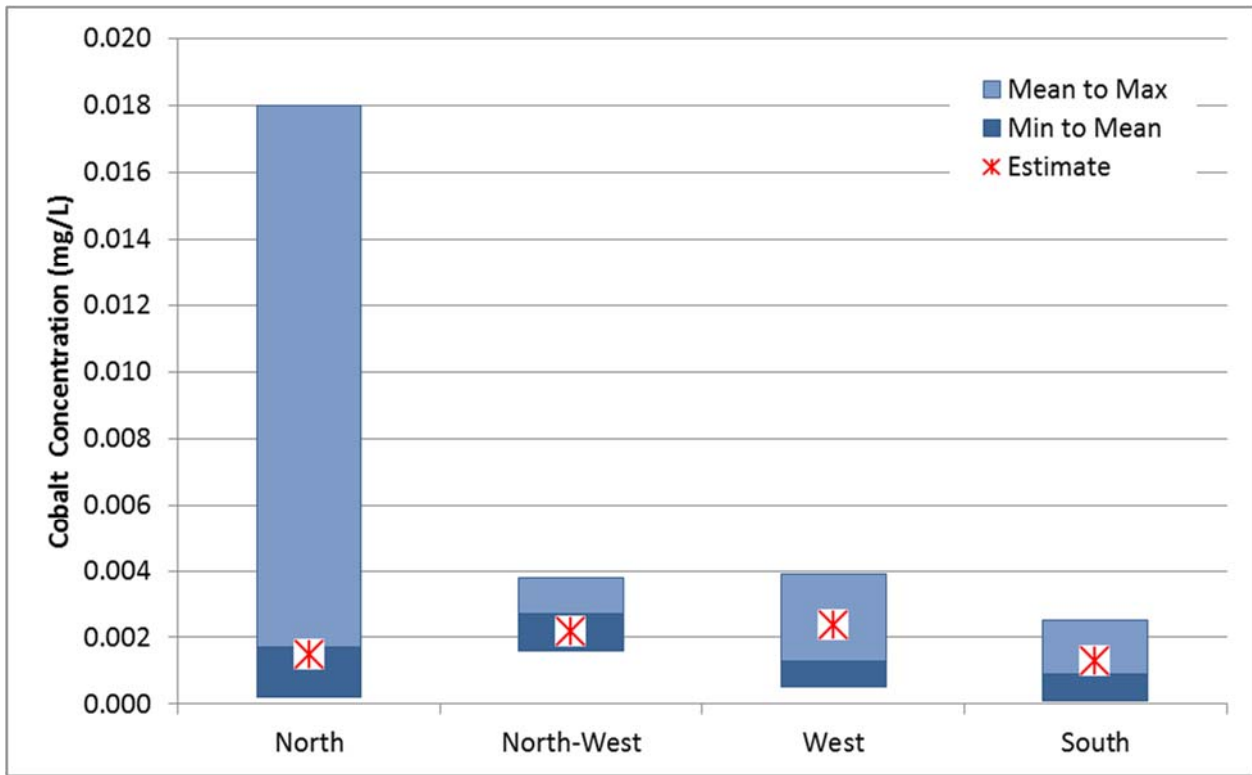

**Figure 10-7 Cobalt concentrations of the calibrated existing conditions model**

As for the sulfate calibration plot (Figure 10-5), the model results do not perfectly match the data. However, these release ratio factors are clearly needed because model estimates of cobalt concentrations between 2 mg/L and 5 mg/L are not acceptable when the sampled data shows ~2 µg/L.

The correction factors mentioned in this section (one sulfate release factor for coarse tailings, one sulfate release factor for fine tailings, and one release ratio factor for each of the other constituents) only apply to the existing LTVSMC tailings because the field data is only representative of those tailings (Table 1-1 and Table 1-21 of Attachment B to Reference (40)). No correction factors have been applied to the Flotation Tailings because field data does not exist to defensibly modify the laboratory release rates.

### 10.3 Saturation and Oxygen Diffusion

This section explains the governing equations and the input variables that are used in the water quality modeling to determine saturation and oxygen diffusion.

Oxygen is the necessary driver in the pyrrhotite reaction which produces sulfate. Equation 10-9 is the chemical reaction used in the water quality modeling (Reference (7)). It states that for every 9 moles of oxygen consumed, 4 moles of sulfate are produced. This ratio (4:9) is a direct input in the water quality model.

Date: February 13, 2015	NorthMet Project Waste Characterization Data Package
Version: 12	Page 141

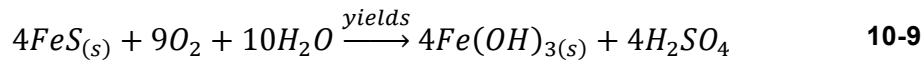

The quantity of oxygen within the tailings is controlled by the chemical reaction rate and the rate at which oxygen can diffuse into the tailings from the atmosphere. Equation 10-10 is the assumed governing oxygen transport equation. It is a steady-state, one-dimensional form of Fick's law with a zero-order reaction term.

$$r = D \frac{\partial^2 C}{\partial z^2} \quad 10-10$$

where  $r$  is the rate at which oxygen is consumed [mol/m<sup>3</sup>/s],  $D$  is the diffusion rate [m<sup>2</sup>/s],  $C$  is the concentration of oxygen at any depth [mol/m<sup>3</sup>] and  $z$  is depth [m] ( $z = 0$  at the surface and is positive downward). The diffusion rate is largely controlled by the saturation of the tailings. Equation 10-11 is used to calculate  $D$  from saturation (Reference (7)).

$$D = \tau D_a [1 - S]^c + \tau S \frac{D_w}{K_H} \quad 10-11$$

where  $\tau$  is the tortuosity factor [--] and equals 0.273,  $D_a$  is the free diffusion coefficient of oxygen in air [m<sup>2</sup>/s] and equals 1.80x10<sup>-5</sup>,  $c$  is an empirical coefficient [--] and equals 3.28,  $D_w$  is the free diffusion coefficient of oxygen in water [m<sup>2</sup>/s] and equals 2.20x10<sup>-9</sup>,  $S$  is the saturation [--] and  $K_H$  is Henry's constant for oxygen [--] and equals 33.9 (Reference (7)).

Using this calculation method, the production of sulfate is a function of the available amount of water and the hydraulic properties of the tailings, which together will determine the saturation of the tailings. Because a portion of the tailings is not completely saturated unsaturated flow equations must be used.

### 10.3.1 Unsaturated Flow

A steady-state Richard's Equation (10-12) is the governing equation for volumetric water content in an unsaturated media and is a modification of Darcy's Law which is used for flow in porous saturated media.

$$0 = \frac{\partial}{\partial z} \left[ K \left( \frac{\partial \phi}{\partial z} + 1 \right) \right] \quad 10-12$$

where  $K$  is the unsaturated hydraulic conductivity [L/T] ranging from 0 cm/s to the saturated hydraulic conductivity ( $K_{sat}$ ) and  $\phi$  is the pressure head [L].

The Van Genuchten model (Equation 10-13) is used to determine the water content as a function of the pressure head and the tailings specific hydraulic properties.

Date: February 13, 2015	NorthMet Project Waste Characterization Data Package
Version: 12	Page 142

$$\sigma = \theta_r + \frac{\theta - \theta_r}{(1 + \alpha|\varphi|^\beta)^\gamma} \quad 10-13$$

where  $\sigma$  is the volumetric content [ $\text{cm}^3/\text{cm}^3$ ],  $\theta_r$  is the residual moisture content [ $\text{cm}^3/\text{cm}^3$ ],  $\theta$  is the porosity or the saturated moisture content [ $\text{cm}^3/\text{cm}^3$ ],  $\alpha$  is the air entry suction [ $1/\text{cm}$ ],  $\beta$  is a Van Genuchten parameter [--] and  $\gamma$  is related to  $\beta$  by  $\gamma = 1 - 1/\beta$ . All of the parameters in the Van Genuchten model are related to the characteristics of the tailings beaches. Using laboratory data, they have been related to the % fines (by mass) and the porosity of the beach, as discussed below.

The *effective* water saturation is related to the moisture content using equation 10-14.

$$S_e = \frac{\sigma - \theta_r}{\theta - \theta_r} \quad 10-14$$

$K$  is related to the *effective* water saturation using Equation 10-15.  $K$  is the known infiltration rate which, in unsaturated flow, is naturally less than  $K_{sat}$ .

$$K = K_{sat}(S_e^{0.5}) \left[ 1 - \left( 1 - S_e^{1/\gamma} \right)^\gamma \right]^2 \quad 10-15$$

These four unsaturated flow equations are highly non-linear and must be solved simultaneously using an iterative approach. Once they are solved, the *effective* saturation can be converted to the real saturation (Equation 10-16), which is used in Equation 10-11 to calculate the diffusion rate.

$$S = \frac{\sigma}{\theta} \quad 10-16$$

### 10.3.2 Hydraulic Parameters for Flotation Tailings

Daniel B. Stephens and Associates (DBS&A) in Albuquerque, New Mexico received a large sample of tailings from pilot plant testing of NorthMet ore. As described in their laboratory report (included as Attachment G), the tailings were separated into coarse and fine fractions (split on a #200 sieve) and re-mixed into four different blends based on percent fine by mass. Each of the four blends was also given three different target porosity values, making a total of twelve samples that were further tested. Table 10-2 summarizes hydraulic parameters of the twelve samples and the results from the tests. The original data is provided in Attachment G.

**Table 10-2 Hydraulic Parameter Results from the DBS&A Laboratory Study**

Blend	% Fines	$\theta$	Bulk Density	$K_{sat}$	$\alpha$	$\beta$	$\theta_r$
	[g/g]	[-]	[g/cm <sup>3</sup> ]	[cm/s]	[1/cm]	[-]	[-]
1	0.77	0.381	1.85	7.4E-05	0.0028	4.4060	0.0210
2	0.77	0.453	1.64	1.4E-04	0.0037	2.3302	0.0204
3	0.77	0.557	1.32	4.9E-04	0.0032	1.5352	0.0000
4	0.56	0.396	1.80	2.4E-04	0.0039	3.4263	0.0155
5	0.56	0.452	1.63	5.2E-04	0.0049	2.3810	0.0136
6	0.56	0.558	1.32	1.4E-03	0.0097	1.5315	0.0020
7	0.37	0.397	1.80	6.9E-04	0.0112	1.9686	0.0208
8	0.37	0.452	1.63	2.0E-03	0.0065	2.6280	0.0117
9	0.37	0.560	1.31	1.3E-03	0.0066	2.4829	0.0118
10	0.21	0.448	1.64	3.7E-03	0.0106	2.7451	0.0081
11	0.21	0.503	1.48	3.9E-03	0.0148	2.7336	0.0107
12	0.21	0.551	1.34	9.8E-03	0.0127	2.6317	0.0095

First, the results for % fines, porosity ( $\theta$ ) and bulk density were used to develop a best-fit for the specific gravity of both the coarse and fine solids. The results from this best-fit study showed that the specific gravity for the coarse and fine solids is 2.97 and 2.99 respectively. DBS&A measured the specific gravity of both the coarse and fine fractions and the results were 2.98 and 3.00. The essentially identical comparison shows the strong confidence in the calculation and measurements and that both fractions can be assumed to have a specific gravity of 3.0.

Second, the results for the van Genuchten parameters were used to create surface functions that solve for these parameters based on the % fines and  $\theta$  as independent variables. These functions are used in the probabilistic water quality model to determine the hydraulic parameters of the tailings. The hydraulic parameters themselves are not considered random variables in the model. However, the variability in these parameters is accounted for by simulating the uncertainty in the % fines and the porosity.

Equations 10-17 and 10-18 show the format of the surfaces fit to the laboratory data. The coefficients were solved for using best-fits to the data and they are shown in Table 10-3.

$$\log(K_{sat}) = m_m(F)(\theta) + b_m(\theta) + m_b(F) + b_b \quad \mathbf{10-17}$$

$$\alpha, \beta, \theta_r = m_m(F)(\theta) + b_m(\theta) + m_b(F) + b_b \quad \mathbf{10-18}$$

where  $F$  is the % fines in the tailings and  $\theta$  is the porosity.

**Table 10-3 Coefficients used to Determine Hydraulic Parameters (Eq. 10-17 & 10-18)**

Value	Units	mm	bm	mb	bb
Ksat	[cm/s]	2.7930	2.4585	-3.6293	-3.1175
$\alpha$	[1/cm]	0.002036	0.008121	-0.015927	0.010728
$\beta$	[--]	-31.3442	8.6015	14.6871	-1.4748
$\theta_r$	[--]	-0.2417	0.0543	0.1173	-0.0155

Figure 10-8 through Figure 10-11 show the resulting surfaces used to determine hydraulic properties as a function of the random independent variables % fines and porosity. In each case, the surface is colored from blue (low value) to red (high value). The laboratory data are also shown alongside the surface (black circles) to show how the data fit to the surface.

It is important to note that these hydraulic parameters are used primarily for the water quality modeling in the NorthMet beaches. In those areas, the % fines is typically between 0.30 and 0.40 and the porosity is typically between 0.38 and 0.45 as described in Section 5.1.3.1.

Table 10-4 shows the assumed van Genuchten parameters for the bentonite-amended tailings (both NorthMet and LTVSMC) which will be used to cover the dams and the beaches in reclamation. The values are taken from HYDRUS-1D using the default soil properties of a silty-clay.

**Table 10-4 Van Genuchten parameters for the bentonite-amended tailings**

% Solid Volume is bentonite	Saturated Hydraulic Conductivity	Porosity	Residual Moisture Content	Van Gen. $\alpha$	Van Gen. $\beta$
[--]	[cm/s]	[--]	[--]	[1/cm]	[--]
3%	5.56e-06	0.36	0.07	0.005	1.09

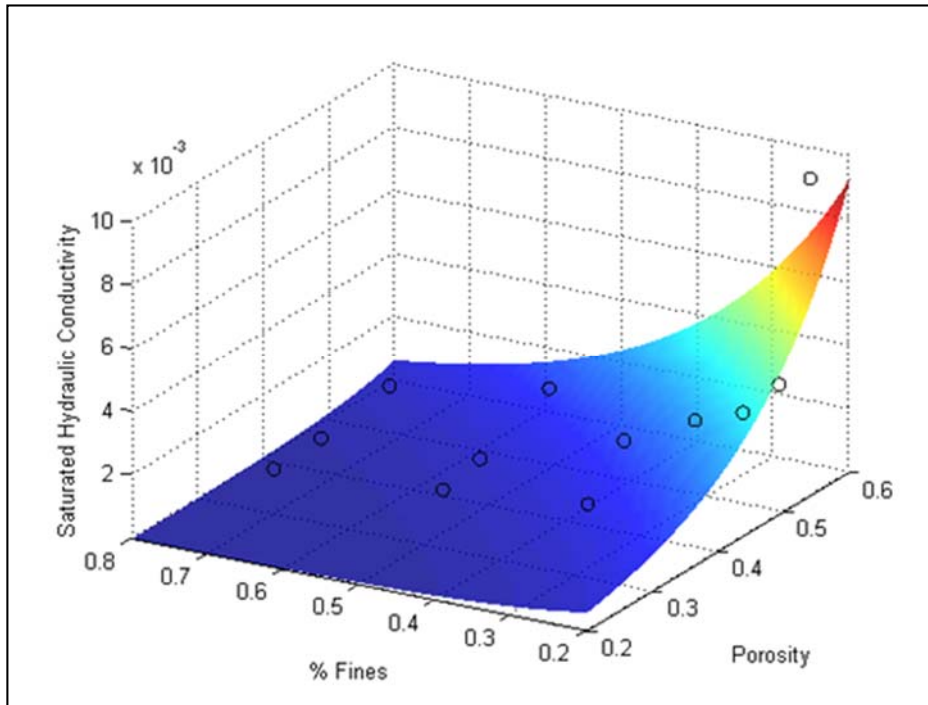

Figure 10-8 Saturated Hydraulic Conductivity ( $K_{sat}$ ) Surface

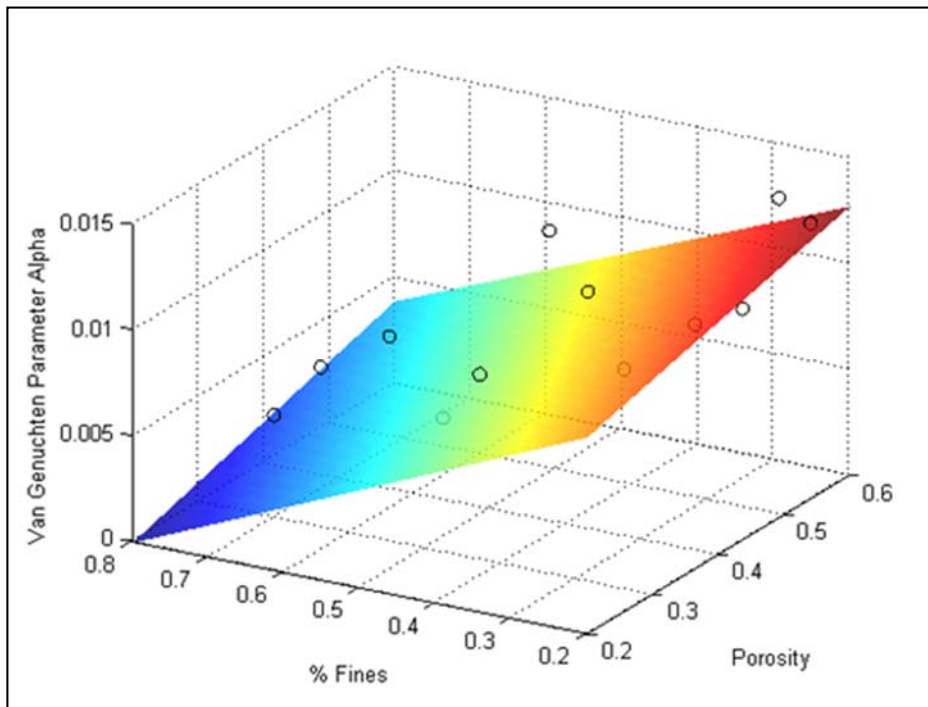

Figure 10-9 Van Genuchten Parameter  $\alpha$  Surface

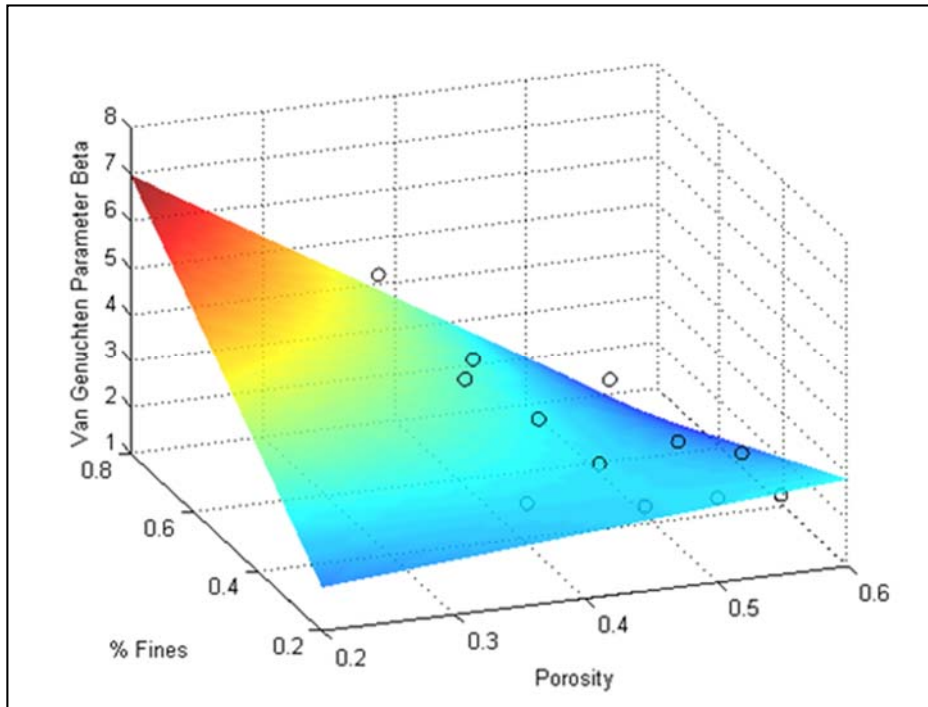

Figure 10-10 Van Genuchten Parameter  $\beta$  Surface

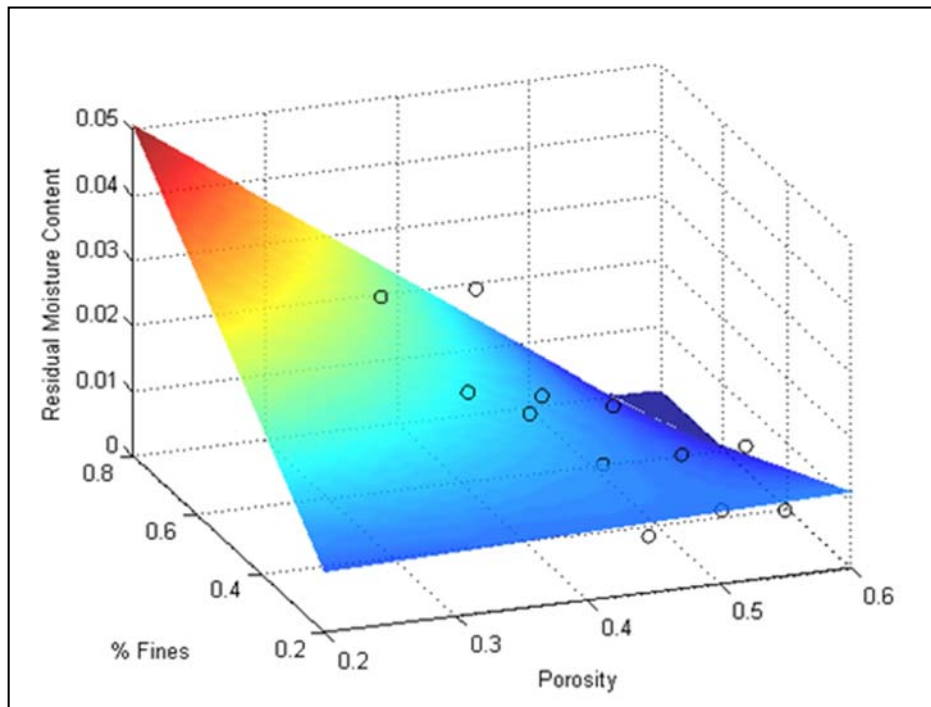

Figure 10-11 Residual Moisture Content ( $\theta_r$ ) Surface





Date: February 13, 2015	NorthMet Project Waste Characterization Data Package
Version: 12	Page 147

### 10.3.2.1 Expected Saturation Levels of the FTB Dams and Beaches

In contrast to the modeling of the Flotation Tailings Basin for the DEIS, saturation is not a direct input into the current modeling. Instead, saturation is calculated as shown in Section 10.3.1. This section describes the expected, model-calculated saturation levels in the Flotation Tailings Basin (dams and beaches) based on hydraulic characteristics and available water for infiltration,

During early years of operations (up to Mine Year 7), there is only one dam constructed to form the FTB; the North Dam. During those early years, there is also only one beach which receives all of the Beneficiation Plant discharge. Because of the high discharge rate from the Beneficiation Plant, the beach saturation is maintained at a high level, approximately between 45% and 48% saturation as defined by Equation 10-16. Once the two cells of the FTB combine, the discharge from the Beneficiation Plant is moved around the basin to build up all three dams and beaches. This means that during each year, each beach will go through a period of high saturation (when the Beneficiation Plant is discharging to it) and low saturation (when the Beneficiation Plant is not discharging to it). Finally, upon closure, the beaches do not receive discharge from the Beneficiation Plant and are only wetted by precipitation. Additionally, the beaches are covered by a bentonite-amended tailings layer which, due to its hydraulic properties, maintains a very high saturation level. See Table 10-5 for a full summary of the expected saturation levels.

In Table 10-5, Mine Years 1 and 7 are when only the North Dam exists. Mine Year 19 is towards the end of operations when the FTB Pond is completely surrounded by the NorthMet beach. Mine Year “19 (dry)” represents the times of the year when the Beneficiation Plant is *not* discharging to that particular beach. It makes sense that those values are the same for all beaches because it is only affected by precipitation. Mine Year “19 (wet)” represents the times of the year when the Beneficiation Plant *is* discharging to that particular beach. The saturation during those times is dependent on the duration of discharge.

In the DEIS modeling (Reference (8)), saturation levels of NorthMet bulk tailings during in closure were estimated to be about 58%. Initial modeling of the separate NorthMet coarse and fine tailings estimated saturation levels in closure of 28% and 80%, respectively. The saturation levels of the dams were estimated at 35% in closure (no bentonite amendment), and the bentonite-amended layer of the beaches was estimated at 93%. According to the hydraulic properties described in Section 10.3.2, the saturation levels of the Flotation Tailings beneath the bentonite-amended layer in the SDEIS modeling should be closer to the NorthMet *coarse* tailings of the DEIS modeling. The modeled saturation of the Flotation Tailings is different from the estimated saturation of the NorthMet coarse tailings of the DEIS modeling because the measured material hydraulic properties are different from those assumed for the DEIS modeling (notably a change in the porosity and the saturated hydraulic conductivity).

**Table 10-5 Expected Saturation (%) in the Tailings Layers of the FTB**

Tailings Layer <sup>(1)</sup>		Mine Year				
		1	7	19 (dry)	19 (wet)	Closure
North Dam	Beach	45-47	46-48	18-22	36-39	14-22
	Beach-BNT	--	--	--	--	95-97
	Dam	45-53	45-53	45-53	--	45-53
	Dam-BNT	97-98	97-98	97-98	--	97-98
East Dam	Beach	--	--	18-22	25-34	14-22
	Beach-BNT	--	--	--	--	95-97
	Dam	--	--	45-53	--	45-53
	Dam-BNT	--	--	97-98	--	97-98
South Dam	Beach	--	--	18-22	33-41	14-22
	Beach-BNT	--	--	--	--	95-97
	Dam	--	--	45-53	--	45-53
	Dam-BNT	--	--	97-98	--	97-98
Closure	Beach	--	--	18-22	35-38	14-22
	Beach-BNT	--	--	--	--	95-97

(1) "Beach" represents the Flotation Tailings that are not amended with bentonite, "Beach-BNT" represents the layer of bentonite-amended Flotation Tailings (only in closure), "Dam" represents the LTVSMC tailings used to construct the dams, "Dam-BNT" represents the bentonite-amended LTVSMC tailings used to cover the newly constructed dams.

### 10.3.2.2 Expected Saturation Levels Below the FTB Pond

Upon closure, the Flotation Tailings below the bentonite-amended layer in the FTB Pond bottom will transition from a saturated to an unsaturated state. Although the Flotation Tailings in this area will be unsaturated, the load generation in the tailings below the FTB Pond will be limited by transport of dissolved oxygen in the downward-seeping water (see Section 10.6.1). The estimated saturation levels below the FTB Pond are provided here for reference only and are not used to calculate loading rates in the water quality modeling.

Saturation levels below the bentonite-amended layer were estimated assuming a) steady, downward flow and, hence, a water table far below the seepage face and b) steady flow under the influence of a water table. The Buckingham-Darcy flux law, a modification of Darcy's Law to account for the non-linear function of unsaturated hydraulic conductivity with respect to pressure head was used to solve for saturation under steady, downward flow. At steady state, the Buckingham-Darcy equation is as shown in Equation 10-19:

$$J_w = -K(h) \left[ \frac{dh}{dz} + 1 \right] \quad 10-19$$

where  $J_w$  is water flux per unit cross-sectional area per unit time [L/T],  $K(h)$  is the unsaturated hydraulic conductivity [L/T] and  $h$  is the pressure head [L]. Assuming steady, downward flow with a sufficiently deep water table, the water flux,  $J_w$ , simplifies to Equation 10-20:

$$J_w = -K(h) \quad 10-20$$

The unsaturated hydraulic conductivity function,  $K(h)$ , can be defined using the van Genuchten relationship (Equation 10-21), which can also be written in terms of saturation (Equation 10-22):

$$K(S_e) = K_{sat} S_e^l \left[ 1 - \left( 1 - S_e^m \right)^m \right]^2 \quad 10-21$$

$$S_e = \frac{\theta - \theta_r}{\theta_s - \theta_r} \quad 10-22$$

Where  $S_e$  is the effective saturation [unitless],  $K_{sat}$  is saturated hydraulic conductivity [L/T],  $l$  is a pore connectivity factor [unitless],  $m$  is a fitting parameter [unitless],  $\theta$  is water content [L<sup>3</sup>/L<sup>3</sup>],  $\theta_r$  is residual water content [L<sup>3</sup>/L<sup>3</sup>] and  $\theta_s$  is saturated water content [L<sup>3</sup>/L<sup>3</sup>].

The parameters for Equation 10-21 were estimated from the surface functions shown in Figure 10-8 through Figure 10-11 assuming 68% fines and a porosity of 0.52 (Equation 10-17, Equation 10-18, and Table 10-3). These values of 68% fines and 0.52 porosity are based on the assumptions of 35% fines in the Flotation Tailings beaches, 30% delivery of Flotation Tailings delivery to the beaches (70% subaqueously), and 38% coarse material in the feed. The resulting values for  $K_{sat}$ ,  $l$ ,  $m$  (or  $1 - 1/\beta$ ),  $\theta_s$  and  $\theta_r$  were estimated for the Flotation Tailings to be  $4.8 \times 10^{-4}$  cm/sec, 0.5, 0.474, 0.52 and 0.007, respectively. Using these parameter values and the design seepage rate of 6.5 inches/year through the bentonite-amended layer (Section 5 of Reference (36)) the Flotation Tailings saturation under steady, downward flow was estimated to be 33% using the analytical solution of the Buckingham-Darcy flux law. This saturation is equivalent to a volumetric water content of about 0.171, resulting in an effective saturation ( $S_e$ ) of about 0.32 (see Equation 10-22). Assuming free gravity drainage (or sufficient vertical distance above the water table) using Equation 10-21, an effective saturation of 0.32, and the other parameter values mentioned above as a double-check yields a  $K(S_e)$  of  $5.233 \times 10^{-7}$  cm/sec which is equivalent to an unsaturated flow rate of 6.5 in/yr.

Date: February 13, 2015	NorthMet Project Waste Characterization Data Package
Version: 12	Page 150

To estimate saturation assuming the presence of a water table below the FTB, a numerical solution to the Richard's Equation, the governing equation for transient, unsaturated flow, was used (Equation 10-23):

$$\frac{\partial \theta(h)}{\partial t} = \frac{\partial}{\partial z} \left[ K(h) \left( \frac{\partial h}{\partial z} \right) \right] + \frac{\partial K(h)}{\partial z} - S(h) \quad 10-23$$

where  $S(h)$  is a sink function [ $T^{-1}$ ]. The van Genuchten model relating pressure head to water content was used and the unsaturated flow equations were solved numerically using the HYDRUS-1D software package and the same input parameters used above for the analytical solution. The top model boundary condition was set as a constant flux of 6.5 inches/year, the seepage rate for the long-term closure FTB, and the bottom boundary condition was set at a constant pressure head of 0 m at a depth 17.5 m below the model top, representative of the water table. Using this numerical simulation, the effects of the water table were incorporated and the saturation was found to vary between 33% immediately below the bentonite amended Flotation Tailings to 100% (saturated) at the water table with an average saturation of 44%. As dictated by the model boundary condition, the steady state model resulted in fluxes through the top and bottom model boundaries of 6.5 inches/year.

Although the Flotation Tailings below the FTB Pond will not be fully saturated, oxygen delivery to this material is limited to the dissolved oxygen carried in the seepage through the bentonite-amended layer. Unlike the unsaturated tailings in the FTB dams and beaches, there will be no diffusion of atmospheric oxygen to the Flotation Tailings below the FTB Pond. Constituent release from this material is modeled as discussed in Section 10.6.1 and is not a function of the saturation levels discussed here.

### 10.3.3 Hydraulic Parameters for LTVSMC Tailings

The existing LTVSMC tailings are included in the probabilistic water quality model. The Van Genuchten parameters for these tailings must be known in order to perform the unsaturated hydraulic modeling. The geotechnical seepage and stability modeling being performed for the Project also incorporates the moisture-release characteristics of the existing LTVSMC tailings. For consistency, the input values used for the seepage and stability modeling inform the values used in the water quality modeling.

The geotechnical seepage and stability model includes the three classes of LTVSMC tailings used in the water quality modeling which are: coarse tailings, fine tailings, and bulk tailings (used to construct the planned dams). The parameters used in the geotechnical modeling are specific gravity, porosity, and residual moisture content. The remaining required Van Genuchten parameters in the water quality model ( $\alpha$  and  $\beta$ ), are based on the D60 and D10 information obtained from lab tests of the LTVSMC tailings (Table 10-7) and estimates from available literature data (Reference (41)). The saturated hydraulic conductivity values needed were taken from the calibrated existing conditions MODFLOW model described in Section 5.4 of Reference (40) and are shown in Table 10-6.

Table 10-7 shows a summary of the values used for the unsaturated hydraulic modeling of the existing LTVSMC tailings.

**Table 10-6 Saturated Hydraulic Conductivity Values for the Existing LTVSMC Tailings**

	Cell 1E [cm/s]	Cell 2E [cm/s]	Cell 2W [cm/s]
LTVSMC Coarse Tailings	4.43e-03	1.76e-03	1.42e-03
LTVSMC Fine Tailings	2.12e-05	3.77e-04	7.06e-05

Note:

Values come from the calibrated MODFLOW model (Large Table 1 of Attachment A to Reference (40))

**Table 10-7 Van Genuchten Parameters for the Existing LTVSMC Tailings**

Fraction	D <sub>10</sub> <sup>(1)</sup>	D <sub>60</sub> <sup>(1)</sup>	Specific Gravity <sup>(1)</sup>	Saturated Hydraulic Cond.	Porosity <sup>(1)</sup>	Residual Moisture Content <sup>(1)</sup>	Van Gen. α <sup>(2)</sup>	Van Gen. β <sup>(2)</sup>
	[mm]	[mm]	[--]	[cm/s]	[--]	[--]	[1/cm]	[--]
Coarse	0.05	0.70	2.80	Table 10-6	0.412	0.041	0.024	2.0
Fine	0.045	0.03	2.90	Table 10-6	0.493	0.059	0.001	1.6
Bulk	0.03	0.25	2.85	8.02e-05 <sup>(1)</sup>	0.440	0.048	0.011	2.0

(1) Values adopted from the geotechnical seepage and stability modeling (Reference (42), Sections 5.2.1, 5.2.2, and 5.8).

(2) Values derived from measured particle size distribution and literature values (Reference (41)).

### 10.3.4 Oxygen Diffusion

To determine the oxygen profile and the depth to which oxygen is available for consumption, the oxygen transport equation (Equation 10-10) must be solved and the rates at which oxygen is consumed and diffuses into the tailings must be known. The diffusion rate is dependent on saturation, as shown in Equation 10-11. The oxygen consumption rate is dependent on the sulfate production rate which is a random variable in the water quality model (Section 10.1).

Because the relationship between oxygen consumption and sulfate production is known (Equation 10-9), the mass sulfate production rate can be used to determine the molar oxygen consumption rate. For example, if sulfate is produced at a rate of 5 mg of sulfate per kg of tailings per week, the bulk density of the tailings is 1.50, the porosity of the tailings is 0.50 and the concentration of oxygen in air is 8.89 moles per cubic meter of air, then the oxygen consumption rate is  $1.83 \times 10^{-7}$  moles per cubic meter of air per second.

Date: February 13, 2015	NorthMet Project Waste Characterization Data Package
Version: 12	Page 152

The general form of the solution to Equation 10-10 is shown in Equation 10-24.

$$C(z) = \frac{r}{2D}z^2 + C_1z + C_2 \quad \mathbf{10-24}$$

The boundary conditions used to solve for the unknown coefficients  $C_1$  and  $C_2$  are that the concentration at the surface is equal to the concentration of oxygen in air ( $C_o$ ) (Equation 10-25) and that the concentration and the concentration gradient both go to zero at the same depth (Equation 10-26).

$$C(0) = C_o \quad \mathbf{10-25}$$

$$C(z') = \frac{\partial C(z')}{\partial z} = 0 \quad \mathbf{10-26}$$

From the general solution and the boundary conditions, the specific solution is shown in Equation 10-27. An additional limitation is that the tailings are only producing sulfate to the depth where the oxygen profile goes to zero. The depth at which oxygen is completely depleted ( $z'$ ) is shown in Equation 10-28. Figure 10-12 shows an example oxygen profile given that the concentration of oxygen in air is  $8.89 \text{ mol/m}^3$ , the reaction rate is  $1.83 \times 10^{-7} \text{ mol/m}^3/\text{sec}$  and the diffusion rate is  $4.117 \times 10^{-8} \text{ m}^2/\text{sec}$ .

$$C(z) = \frac{r}{2D}z^2 - \left(\frac{2C_o r}{D}\right)^{0.5} (z) + C_o \quad \mathbf{10-27}$$

$$z' = \left(\frac{2C_o D}{r}\right)^{0.5} \quad \mathbf{10-28}$$

Figure 10-13 shows the effect of the  $r/D$  ratio on the oxygen profile. Intuitively, if the rate at which oxygen is consumed is high compared to the rate at which oxygen can diffuse, the penetration depth of oxygen will be quite shallow. At an  $r/D$  ratio of 4, the penetration depth is about 2 meters. On the other hand, if oxygen is not being consumed quickly compared to the diffusion rate ( $r/D = 0.25$  for example), then the penetration depth is quite deep, around 8 meters.

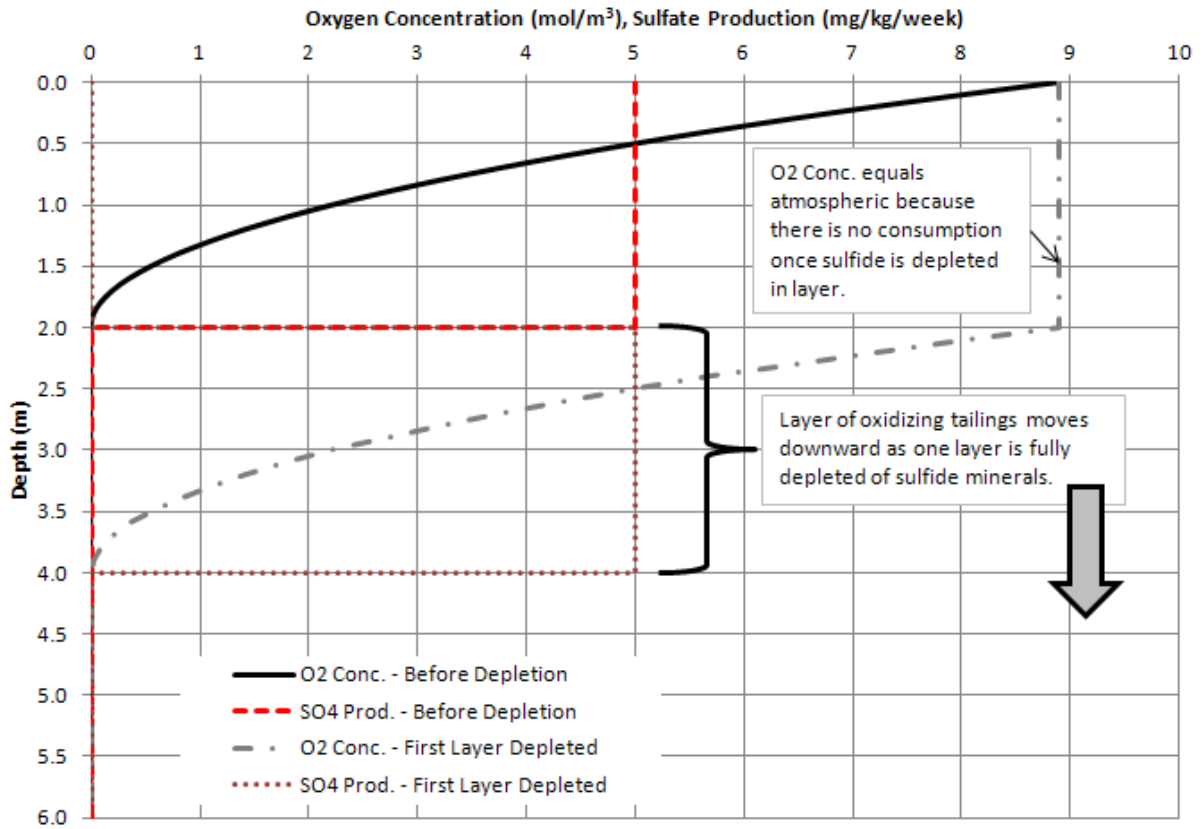
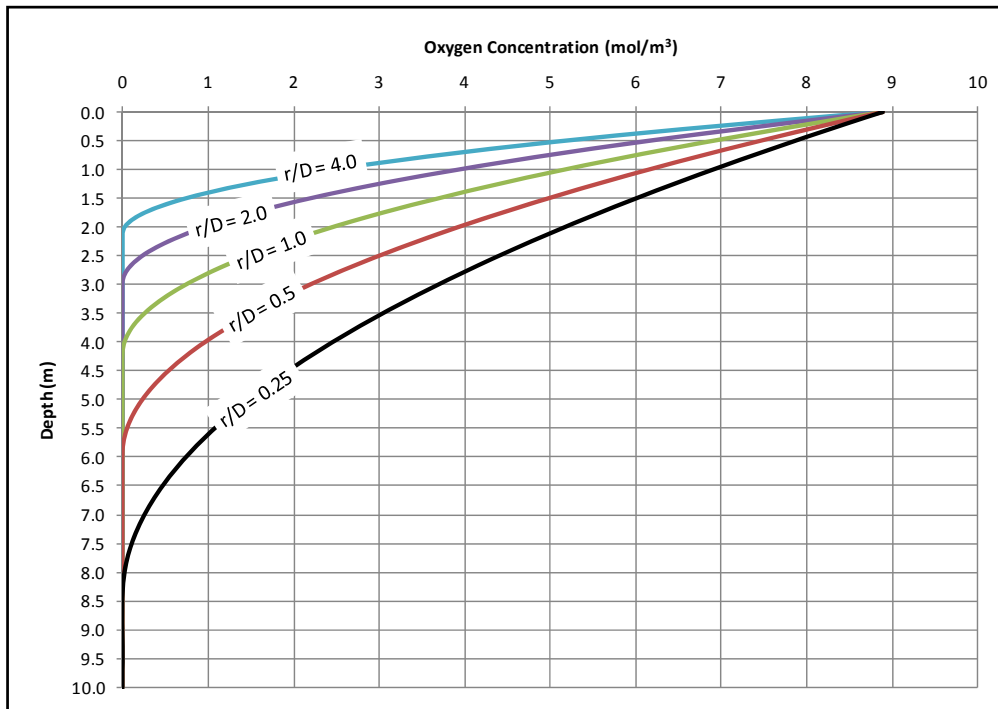

Figure 10-12 Example Oxygen Concentration and Sulfate Production Profile



**Figure 10-13 Oxygen Profiles at Different  $r/D$  Ratios**

As shown in Figure 10-12, sulfate and other constituents where release is dependent on sulfate release, are only produced to a calculated depth to which oxygen can penetrate at any given time (~ 2 meters in the example of Figure 10-12, calculated by Equation 10-28). Within the oxygenated zone, sulfate (and other constituents) are produced at a constant rate (zero-order Fick's Law, Equation 10-10). Below the oxygenated zone, load of these constituents is not generated at any given time. However, as also shown in Figure 10-12, eventually Flotation Tailings near the surface of the Tailings Basin will be depleted of sulfides and will cease to consume oxygen. At this point, oxygen will be able to fully diffuse through those tailings to a depth where oxygen-consuming sulfides are present. The effect is an advancing front of layers of oxygen-consuming, sulfate-producing tailings. This will occur until the entire Tailings Basin is depleted of modeled constituent mass.

#### 10.4 Concentration Caps

The concentration caps developed for the Category 1 waste rock (Sections 4.1.3.1 and 8.3 are applied to the metal concentrations determined from the above analysis. The use of Category 1 waste rock as an analog for the Flotation Tailings is appropriate because of the similar sulfur content and because the Flotation Tailings are also anticipated to remain nonacidic. As documented in previous waste characterization reports (Appendix D.1 of Reference (3) and Appendix B.1 of Reference (7)), the mineralogy of the Category 1 waste rock and the Flotation Tailings is broadly similar. Both the Category 1 waste rock and the Flotation Tailings are primarily composed of plagioclase (30-88% of WR, 50-80% of FT), with lower





Date: February 13, 2015	NorthMet Project Waste Characterization Data Package
Version: 12	Page 155

levels of olivine (tr-55% of WR, 10-15% of FT) and clinopyroxene (tr-25% of WR, 4-5% of FT). Neither the waste rock nor the tailings contain carbonates. Sulfide levels in both sets of samples are low, with “trace” levels of sulfides in the waste rock and less than 0.5% in the tailings; sulfides are primarily pyrrhotite and chalcopyrite (in approximately equal proportions in WR, dominated by pyrrhotite in FT).

As discussed in Section 8.3 for waste rock stockpiles, it has been suggested that elevated partial pressures of carbon dioxide ( $p\text{CO}_2$ ) could cause pH depression below what has been observed in the laboratory tests of Category 1 waste rock. The Flotation Tailings (like the Category 1 waste rock) are virtually lacking in carbonates to serve as a source of  $\text{CO}_2$  (References (3) and (7)). However, elevated  $\text{CO}_2$  has been inferred from MDNR geochemical modeling of the existing LTVSMC tailings (Reference (27)) and in the leach extraction tests on LTVSMC tailings (which contain carbonates). Observed  $p\text{CO}_2$  in the LTVSMC tailings is approximately  $10^{-2}$  atm. Because Flotation Tailings will be placed on LTVSMC tailings and LTVSMC tailings will be used for dam construction, this effect may cause changes in the pH of the tailings in certain portions of the basin

The pH observed in the laboratory testing of Category 1 waste rock to develop concentration caps (Attachment B) was approximately 8. If the pH of the Flotation Tailings is depressed below the laboratory-indicated levels, the solubility of several metals could be significantly different from what was observed in the laboratory tests. Based on the humidity cell testing, the relevant metals for the Flotation Tailings are cobalt, manganese, nickel, and zinc. As discussed in Sections 8.3.1.5 and 8.3.1.6, concentration cap relationships for these metals have been developed as a function of pH based on the Category 1 laboratory and AMAX field data. Given the sulfur content of the Flotation Tailings, which will likely be process controlled around 0.12 wt% S, and the elevated  $p\text{CO}_2$  assumed ( $10^{-2}$  atm), the pH applied to the water in the pore spaces of the Flotation Tailings is a constant 7.1 (Figure 8-18).

The concentration caps discussed here apply to the Flotation Tailings only, concentration caps are not applied to the LTVSMC tailings beyond the defined release concentrations discussed in Section 10.1.2.2.

### **10.5 Flotation Tailings/LTVSMC Tailings Interaction**

As discussed in Reference (7), column tests on the interaction between the seepage from Flotation Tailings and LTVSMC tailings indicate that for many constituents the chemical loading from the Flotation Tailings and LTVSMC tailings is additive. For one of the major constituents of concern, nickel, the tests indicate that nickel leaching from the Flotation Tailings will likely precipitate within the LTVSMC tailings and loading to the environment will be reduced. For all other constituents, the tests do not show attenuation of Flotation Tailings seepage loading within the LTVSMC tailings. There is no indication that seepage from the Flotation Tailings will cause significant dissolution of minerals precipitated in the LTVSMC tailings.

Date: February 13, 2015	NorthMet Project Waste Characterization Data Package
Version: 12	Page 156

Although the column tests indicate that nickel will likely be removed from the NorthMet seepage water, the tests do not provide sufficient data for definitively quantifying changes in the water chemistry of seepage from Flotation Tailings as it passes through LTVSMC tailings. The probabilistic model, therefore, does not include any change in the seepage chemistry due to sorption or dissolution in the LTVSMC tailings underlying the FTB. This is a conservative assumption with respect to nickel and a proper assumption for all other constituents; nickel concentrations leaving the basin would be lower if the Flotation Tailings/LTVSMC tailings interaction was considered. Constituent loading is added to the seepage water from the unsaturated portions of LTVSMC tailings as described in Sections 10.1 through 10.4.

## 10.6 Additional Model Parameters

### 10.6.1 Oxidation of Saturated Tailings

As discussed in Section 10.2.1, oxygen availability is the primary driver for production of sulfate and other metals. In this section, oxygen availability in the saturated tailings immediately beneath the permanent pond under both operating and closure conditions is discussed.

The design for the FTB permanent pond, as a part of the wet cover system, is a wide and shallow pond. The area of the pond is approximately 400 acres during early years of operation and about 1,100 acres in later years of operation and upon closure. The maximum depth of the pond (as designed) is about 8 feet and the slope of the pond around the edge will be approximately 3%. It is conservative to ignore stratification by assuming the pond will be well mixed and that the dissolved oxygen (DO) levels will always be at saturation.

The solubility of oxygen in water is discussed in depth in Standard Methods for the Examination of Water and Wastewater (Reference (43)). This reference includes tables of the saturated DO concentration of water at atmospheric pressure (101.325 kPa) for different temperatures and chlorinity levels and the functions used to create the tables. It is proposed to use the empirical functions and apply appropriate corrections as necessary. Chlorinity only begins to have an important effect on DO at values greater than 1 g/kg or 1000 mg/L chloride. Previous analysis of the pond water quality estimated values near 6 mg/L. Therefore, chlorinity will not have a significant effect on DO and is ignored (i.e., chloride concentration of zero assumed). The altered function for oxygen solubility is then:

$$\ln C = -139.34411 + \left( \frac{1.575701 \times 10^5}{T} \right) - \left( \frac{6.642308 \times 10^7}{T^2} \right) + \left( \frac{1.2438 \times 10^{10}}{T^3} \right) - \left( \frac{8.621949 \times 10^{11}}{T^4} \right) \quad 10-29$$

where  $C$  is the equilibrium DO concentration at 101.325 kPa [mg/L] and  $T$  is the water temperature [°K] (°C + 273.15). See Figure 10-14 for a graph of results from Equation 10-29.

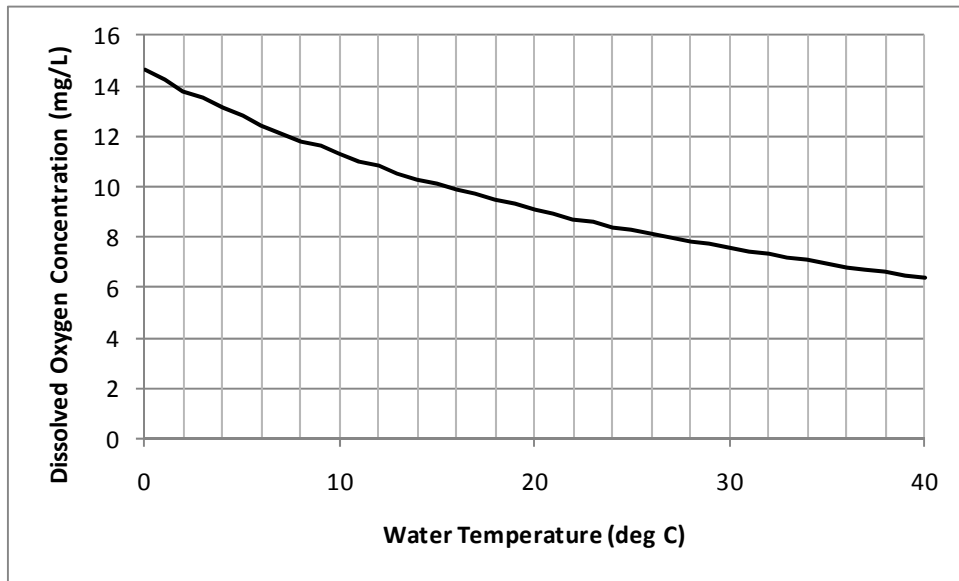

**Figure 10-14 Dissolved Oxygen Concentration as a Function of Water Temperature**

For the probabilistic water quality modeling the above equation and probabilistically generated average monthly pond water temperatures are used to calculate the dissolved oxygen concentration in the pond at each time step. Monthly pond water temperatures are estimated to range from 1 °C to about 22 °C.

Table 10-8 shows air temperature data from nearby stations over the period 1981 through 2010. Previous studies have shown that the pond temperature will be slightly warmer than the air temperature on site due to the elevated temperature of the tailings transport water from the Beneficiation Plant (Attachment A-5 of Reference (44)). Assuming air temperature is equivalent to pond water temperature is therefore conservative because DO concentration increases as temperature decreases. During months when the air temperature is below freezing, the water temperature is assumed to be 1 °C (equivalent to a saturated DO of 14.2 mg/L). The proposed distribution for pond DO in any given month is a normal distribution with a mean at the saturated DO for a given mean air temperature and a standard deviation of 0.5 mg/L. This standard deviation was chosen because > 95% of values in a normal distribution will be between +/- two standard deviations around the mean. Therefore, > 95% of values will fall within a month's mean value +/- 1 mg/L. During months (November through March) when the water temperature is limited to 1 °C because the air temperature is below freezing, the DO concentration in the pond is assumed to be 14.2 mg/L with no variability. Additionally, the distribution for each month is truncated at 14.2 mg/L so that unrealistic values greater than 14.2 mg/L do not occur. Using the mean, min and max temperature values in Table 10-8 and plotting them using Figure 10-14, the distribution parameters appropriately cover the expected range of dissolved oxygen concentrations in any month.

**Table 10-8 Nearby Temperature Data (1981 – 2010) and Proposed Distribution Parameters**

Month	Site Air Temperature (deg C)			Proposed Normal Distribution Parameters for Pond DO (mg/L)	
	Mean	Min	Max	$\mu$	$\sigma$
January	-15.6	-24.2	-8.2	14.2	0
February	-12.7	-18.7	-4.2	14.2	0
March	-5.5	-11.6	0.3	14.2	0
April	2.8	-1.3	7.2	13.5	0.5
May	9.5	4.7	13.2	11.4	0.5
June	14.5	10.5	18.7	10.2	0.5
July	16.9	12.4	20.5	9.7	0.5
August	16.0	11.0	20.3	9.9	0.5
September	11.0	7.5	13.8	11.0	0.5
October	4.1	-0.9	7.7	13.1	0.5
November	-4.2	-9.7	1.3	14.2	0
December	-12.6	-20.4	-7.1	14.2	0

It is assumed that, as water seeps from the pond into the tailings, all available oxygen is consumed very quickly. Therefore, the production of sulfate and other metals is directly related to the concentration of oxygen in the pond and the rate at which the pond water is seeping into the saturated tailings (Equation 10-30).

$$C(I)(A_{pond}) = \dot{M} \quad 10-30$$

where  $C$  [M/L<sup>3</sup>] is the concentration of oxygen in the pond water,  $I$  [L/T] is the rate at which water is infiltrating from the pond into the saturated tailings and  $A_{pond}$  [L<sup>2</sup>] is the surface area of the pond at any given time.  $\dot{M}$  (Equation 10-30) is the mass flux rate of oxygen into the tailings from the pond. Because it is assumed that all of the oxygen is consumed quickly,  $\dot{M}$  is also the consumption rate of oxygen in the tailings. As described by Equation 10-9, the mass production rate of sulfate is calculated using known molecular weights of O<sub>2</sub> and SO<sub>4</sub> and the relationship that 4 moles of sulfate are produced for every 9 moles of oxygen consumed (results in 4 grams of sulfate produced for every 3 grams of oxygen consumed).

For example purposes, if the DO concentration in the pond is 10 mg/L, the infiltration rate is 30 in/yr and the area of the pond is 1,000 acres, then the sulfate production rate is about 9.3 tons/yr or roughly 18.6 pounds/acre/year.

Date: February 13, 2015	NorthMet Project Waste Characterization Data Package
Version: 12	Page 159

### 10.6.2 Tailings Weathering

Water falling on exposed tailing beaches can be expected to dissolve soluble products of weathering and oxidation. The contribution of tailings weathering is a function of the exposed area of tailings. Laboratory-measured humidity cell rates were expressed as mg/m<sup>2</sup>/month, where m<sup>2</sup> reflects the aerial exposure of tailings. Rates have been generated for both coarse and fine fractions, based on the initial period of testing, corresponding to the length of time any portion of the tailings surface is expected to remain exposed before being covered by subsequent deposition (Table 1-17 of Attachment B to Reference (40)). Section 5.1.3.1 describes the variability in the fractions of coarse and fine grained tailings in the beaches (a range of about 30% to 40% fines in the beaches).

During each month in the model, loads are generated and added to the FTB Pond representing load that has been produced on the beaches and washed off due to rainfall. This load is calculated using the per unit area weathering rates, weighted by the fraction of mass represented by each respective grain size. For example, if at one time, the average % fines in a 100 acre tailings beach is 35% and the weathering rates for coarse and fine grain tailings are 1000 and 2000 mg/m<sup>2</sup>/month respectively, then the net load added to the pond (due to precipitation “washing” the beach) would be about 0.6 tons/month.

### 10.6.3 Process Water Loading to Pond

There are two additional loads that are worth consideration for the water quality model: load leaching from weathered ore and load added by reagents.

#### 10.6.3.1 Ore Leaching Load

The load added to the process water that goes to the FTB is due to processing weathered ore that has not been fully “rinsed” by rain in the field. Section 8.2 describes the load leaching from ore in the field at the Mine Site. This is only a portion of what is generated in the field due to the contact factor (Equation 8-9). Therefore, any load that was generated in the field, but was not contacted by water, is added to the process water load during processing. Equation 10-31 is similar to Equation 8-9 and represents the generated load that clung to the ore in the field. Therefore, all of the same generation rates and correction factors are used to calculate this ore leaching load. The differences are using (1 – k<sub>c</sub>) instead of k<sub>c</sub> for the contact factor and using the ore processing rate for mass rather than mass of ore present in a stockpile.

$$L = \dot{M} * t_w * k_T * k_S * (1 - k_c) \quad 10-31$$

where  $L$  [M] is the total available load still with the ore from the Mine Site,  $\dot{M}$  [M/T] is the mass production rate of ore,  $t_w$  [T] is the approximate time that the ore was left in the environment to weather,  $k_T$  [--] is the temperature factor,  $k_S$  [--] is the size factor and  $k_C$  [--] is the water contact factor.  $\dot{M}$  is known from the Mine Plan (30,860 tons per day, Reference (9)) and  $k_T$ ,  $k_S$  and  $k_C$  are all described in Section 8.2. The time that ore is allowed

Date: February 13, 2015	NorthMet Project Waste Characterization Data Package
Version: 12	Page 160

to weather in the environment ( $t_w$ ) is expected to be less than 6 months according to PolyMet but realistically should not be 0 months. Therefore, due to the modeled monthly time step, a uniform distribution is proposed that ranges from 1 month to 6 months for the variable  $t_w$ .

### 10.6.3.2 Reagent Load

The only reagent that is expected to contribute to metal and sulfate concentrations is copper sulfate. The process will involve addition of approximately 55 g of copper sulfate pentahydrate per ton of ore (applied to the average ore processing rate of 30,860 tons per day, Reference (9)). Copper sulfate is added to the process to activate pyrrhotite and improve flotation by reaction of copper with the pyrrhotite surfaces and bind the copper with the product; therefore only the sulfate portion of the chemical load is added to the process water that goes to the FTB Pond. Pilot plant testing has confirmed that this is an appropriate assumption (Reference (7)).

### 10.6.4 Effects of Re-suspension by Wind

Concerns were raised in the NorthMet Impact Assessment Planning process regarding the potential for water quality impacts due to the re-suspension of Flotation Tailings within the FTB Pond. Research at facilities with subaqueous sulfide-bearing tailings in Canada (Reference (45)) has shown that tailings basins with shallow ponds can exhibit significant re-suspension of tailings due to wind effects. The re-suspended tailings are exposed to oxygenated water and can oxidize and release sulfate and metals to the pond water. Such release would represent an additional constituent loading to the pond water, beyond the oxidation described in Section 10.6.1.

The degree to which suspended tailings represent a significant source of sulfate to pond water quality is heavily dependent on the sulfate release rate of the tailings themselves. The sulfate oxidation rate for suspended tailings can be estimated from:

$$R_{sus} = C_{sus} * R_{tailings} \quad 10-32$$

where  $C_{sus}$  [M tailings/L<sup>3</sup>] is the suspended tailings concentration,  $R_{tailings}$  [M SO<sub>4</sub>/M tailings/T] is the sulfate release rate for tailings from humidity cell testing, and  $R_{sus}$  [M SO<sub>4</sub>/L<sup>3</sup>/T] is the resulting sulfate loading rate per unit volume to the tailings pond.

For the fine Flotation Tailings that will be under the FTB Pond,  $R_{tailings}$  ranges from 3.6 to 19.6 mg SO<sub>4</sub>/kg tailings/week, with a mean value of 6.0 mg SO<sub>4</sub>/kg tailings/week (Large Table 16). Suspended tailings concentrations reported for the basins in Reference (45) are on the order of 10-20 mg/L. Using the high-end values for both of these parameters and assuming that the resulting sulfate load is retained in the FTB Pond for 1 year, the calculation in Equation 10-32 yields an increase in sulfate concentration of 0.02 mg/L. If the average suspended tailings concentration is 100 mg/L, the increase in pond sulfate concentration is at most 0.1 mg/L.



Date: February 13, 2015	NorthMet Project Waste Characterization Data Package
Version: 12	Page 161

The additional load to the FTB Pond from tailings re-suspension is negligible compared to the other sources of sulfate load. The reagent loading described in Section 10.6.3 will add load equivalent to approximately 23 mg/L sulfate to the process water going to the FTB Pond. The treated water from the Mine Site will have a sulfate concentration of up to 250 mg/L. Because all other loads from the tailings are calculated as a ratio to sulfate load, metal loads to the FTB Pond from re-suspension are also negligible. The effect of re-suspension due to wind is therefore not included in the probabilistic model.

#### **10.6.5 Buttress Material**

According to Reference (9), a rock buttress will be placed at the north toe of the existing LTVSMC Cell 2E to ensure sufficient geotechnical stability. The buttress will be constructed of waste rock sourced from the LTVSMC waste rock stockpiles near the Plant Site, with a specific material source location to be determined in consultation with MDNR. The buttress material will be hauled directly from the selected stockpile(s) and will not be crushed or screened.

Because no detailed geochemical information is available for the potential sources of buttress material, the water quality modeling assumes that the buttress rock is equivalent to Category 1 waste rock. Chemical loading from this material is modeled according to the methods described in Section 8.0 for Category 1 waste rock, including scaling factors and concentration caps. This assumption may affect the identification of acceptable buttress waste rock source areas in permitting.

#### **10.6.6 Depletion**

The water quality model includes a check for depletion of each modeled constituent from each tailings fraction. This ensures that any simulated very high metal leaching rates do not continue, but consume the available metals within an appropriate time frame and cease.

The average content of each constituent in each tailings fraction type was determined from the Flotation Tailings and LTVSMC tailings data sets. These average values are considered to be deterministic in the water quality modeling and are shown in Table 10-9.

**Table 10-9 Average Metal Content from Aqua Regia Data (ppm)**

Constituent	Flotation Tailings (fine)	Flotation Tailings (coarse)	LTVSMC Tailings (all)
Silver (Ag)	2.13E-01	1.86E-01	7.33E-02
Aluminum (Al)	3.60E+04	3.56E+04	1.92E+02
Alkalinity <sup>1</sup>	--	--	--
Arsenic (As)	2.19E+00	2.43E+00	2.82E+01
Boron (B)	5.00E+00	5.00E+00	5.15E+00
Barium (Ba)	5.36E+01	4.86E+01	1.03E+01
Beryllium (Be)	1.84E-01	1.87E-01	6.92E-01
Calcium (Ca)	1.98E+04	2.04E+04	1.45E+03
Cadmium (Cd)	6.50E-02	6.29E-02	5.74E-02
Chlorine (Cl) <sup>1</sup>	--	--	--
Cobalt (Co)	4.56E+01	5.51E+01	8.22E+00
Chromium (Cr)	9.89E+01	1.08E+02	8.50E+01
Copper (Cu)	2.22E+02	1.10E+02	9.72E+00
Fluoride (F) <sup>1</sup>	--	--	--
Iron (Fe)	5.39E+04	6.78E+04	9.88E+03
Potassium (K)	1.94E+03	1.83E+03	6.24E+01
Magnesium (Mg)	3.30E+04	4.08E+04	8.09E+02
Manganese (Mn)	6.02E+02	7.52E+02	4.61E+03
Sodium (Na)	4.69E+03	4.53E+03	1.11E+01
Nickel (Ni)	2.46E+02	2.89E+02	4.23E+00
Lead (Pb)	3.21E+00	3.39E+00	1.54E+00
Antimony (Sb)	1.21E-01	1.29E-01	8.08E-02
Selenium (Se)	4.30E-01	5.20E-01	4.94E-01
Sulfur (S)	1.05E+03	1.21E+03	4.64E+01
Thallium (Tl)	1.00E-01	8.86E-02	2.00E-02
Vanadium (V)	3.47E+01	4.54E+01	1.00E+01
Zinc (Zn)	5.79E+01	7.04E+01	9.67E+00

(1) Aqua regia data not available for alkalinity, chlorine, and fluoride. No depletion is modeled.





Date: February 13, 2015	NorthMet Project Waste Characterization Data Package
Version: 12	Page 163

## **11.0 Geochemical Parameters – Hydrometallurgical Residue**

As discussed in Section 6.0, the hydrometallurgical residue has been well-characterized based on the pilot-testing results. In addition, the HRF is designed as a double-lined storage area with a permanent geomembrane cover in closure (Section 6.2). The leakage of contaminated water from this facility to the surrounding environment will be negligible and the HRF has not been included as a source in the probabilistic water quality modeling (Reference (13)).

Date: February 13, 2015	NorthMet Project Waste Characterization Data Package
Version: 12	Page 164

## Revision History

Date	Version	Description
2/14/2011	1	Initial release
3/21/2011	2	Added Sections for Waste Rock and Pit Lake: Category 1 Concentration caps Study; 2011 Geochemical Update; Geochemical Parameters – Waste Rock; Geochemical Parameters – Pit Lake; Large Table 3 and Large Table 4
5/16/2011	3	Added Sections for Overburden, Waste Rock, Pit Lake and Tailings: Overburden 2011 Update; Sulfur Content of Stockpiles and Pit Walls; Flotation Tailings 2011 Update; Geochemical Parameters – Overburden; Sulfate Release Rates for Category 1, 2/3 and Ore; Depletion; Concentration Caps (Pit Lake); Age of Pit Walls and Backfill Modeling Parameters; Lab to Field Scale Up (Tailings); Saturation and Oxygen Diffusion; Concentration caps (Tailings); Additional Model Parameters (Tailings); Geochemical Parameters – Hydrometallurgical Residue Edited Sections for Waste Rock and Pit Lake: 2009 and 2011 Updates; All Other Release Rates; Effects of Acidification; Lab to Field Scale Up; Concentration Caps; Long-Term Decay in Constituent Release; Large Tables and Figures
7/22/11	4	<b>Version 4 to accompany submittal of the NorthMet Mine Site Water Modeling Work Plan</b> Updated formatting and performed minor text edits throughout document Added Sections for Waste Rock, Pit Lake and Tailings: Tailings 2011 Geochemical Update; Nitrogen in Waste Rock; Ore Spillage from Rail Cars; Nitrogen in Mine Pits; Subaqueous Oxidation; Dewatered Material Oxidation; Tailings Laboratory Release Rates; NorthMet/LTVSMC Tailings Interaction Edited Sections for Waste Rock, Pit Lake and Tailings: All Other Release Rates (Waste Rock); Effects of Acidification (Waste Rock); Concentration Caps (Waste Rock); Long-term Decay in Constituent Release; Age of Pit Walls; Saturation and Oxygen Diffusion; Geochemical Parameters – Hydrometallurgical Residue; Large Tables and Figures
8/11/11	5	<b>Version 5 to accompany submittal of the NorthMet Plant Site Water Modeling Work Plan</b> Performed minor text edits throughout document Added Sections for Tailings: Scaling/Calibration of LTVSMC Lab Data to Field Data; Effects of Wind Re- Suspension; Buttress Material; Depletion (Tailings) Edited Sections for Tailings: Laboratory Release Rates for Flotation and LTVSMC Tailings; Concentration Caps (Tailings); Process Water Loading to Pond; Large Tables and Figures



Date: February 13, 2015	NorthMet Project Waste Characterization Data Package
Version: 12	Page 165

Date	Version	Description
11/11/11	6	<p><b>Version 6 to accompany submittal of the NorthMet Mine Site Water Modeling Work Plan, Version 4, and the NorthMet Plant Site Water Modeling Work Plan, Version 3</b></p> <p>Performed minor text edits throughout document</p> <p>Added Sections for Waste Rock, Pit Lake and Tailings: Humidity Cell Trends Update (Tailings); Nickel Release (Waste Rock); Chloride Release from Waste Rock; Expected Saturation Levels of the FTB</p> <p>Edited Sections for Overburden, Waste Rock, Pit Lake and Tailings: Geochemical Parameters – Overburden; Category 1 Waste Rock Concentration Caps; Nitrogen in Waste Rock; Ore Spillage from Rail Cars; Virginia Formation highwall modeling; Long-term Decay in Constituent Release; Release from Concentration Caps (Tailings); Lab to Field Scale Up (Tailings); Scaling/Calibration to LTVSMC Field Data; Concentration Caps (Tailings)</p>
1/10/12	7	<p><b>Version 7 to accompany submittal of the NorthMet Mine Site Water Modeling Work Plan, Version 5, and the NorthMet Plant Site Water Modeling Work Plan, Version 3</b></p> <p>Edited Sections for Waste Rock, Pit Lake and Tailings: Category 1 Concentration Caps Study; Flotation Tailings Depositional Study; Tailings Humidity Cell Trends Update; Waste Rock Lab to Field Scale-Up; Category 1 Waste Rock Concentration Caps; Wall Rock Lab to Field Scale-Up; Wall Rock Acidification and Long-Term Decay; Pit Walls and Pit Lake Concentration Caps; Calibration to LTVSMC Field Data; Expected Saturation Levels in the FTB; Tailings Concentration Caps</p> <p>Revised Attachment E, Update on Tailings Humidity Cell Test Data</p>
2/9/12	8	<p><b>Version 8 to accompany submittal of the NorthMet Mine Site Water Modeling Work Plan, Version 6, and the NorthMet Plant Site Water Modeling Work Plan, Version 4</b></p> <p>Revised Section 8.2.3, Particle Size Factor</p> <p>Edited Section 8.2.8, MDNR Category 1 Scale-Up</p> <p>Edited Section 8.3, Concentration Caps (Waste Rock)</p>
7/2/12	9	<p><b>Version 9 to accompany submittal of the NorthMet Mine Site Water Modeling Work Plan, Version 7, and the NorthMet Plant Site Water Modeling Work Plan, Version 6</b></p> <p>Updated based on approved Change Definition forms.</p> <p>Revised Sections 4.3.2, 8.1.2.1, 8.2.8, 8.3.1.4, 9.2, 10.2.1, 10.3.2.1, 10.3.2.2, 0, 10.4.</p> <p>Revised Large Tables 3, 4, 7-9, 12, 13</p> <p>Revised Large Figures 1-2, 5-6, 9-11, 45, 49</p>



Date: February 13, 2015	NorthMet Project Waste Characterization Data Package
Version: 12	Page 166

Date	Version	Description
3/8/13	10	<p><b>Version 10 to accompany submittal of the NorthMet Mine Site Water Modeling Data Package Volume 1 – Mine Site, Version 12, and the NorthMet Plant Site Water Modeling Data Package Volume 2 – Plant Site, Version 9</b></p> <p>Updated based on approved Change Definition forms.  Revised Sections 10.1.1.1 and 10.3.2.2  Revised Large Tables 16 and 17  Revised Large Figures 45 and 49</p>
12/1/14	11	<p><b>Version 11 to accompany submittal of the NorthMet Mine Site Water Modeling Data Package Volume 1 – Mine Site, Version 13, and the NorthMet Plant Site Water Modeling Data Package Volume 2 – Plant Site, Version 10</b></p> <p>Revised Sections 4.1.3, 8.1.1, 8.1.2, 9.5.2, 10.1.1.1, 10.2.1, 10.3.2.2, 10.3.3, minor text revisions throughout.  Added Sections 4.1.4, 5.1.4, 6.1.4.  Added Attachments C and D.  Updated Large Tables 1, 5, 7-9.  Updated Large Figures 1-2, 5-6, 9-10.</p>
2/13/15	12	<p><b>Version 12 to address comments received from the Co-Lead Agencies on Version 11.</b></p> <p>Minor text revisions in Sections 4.1.3, 4.1.4, 5.1.4, 8.1.2.1, 9.5.2, 10.3.2, and 10.3.3. Minor edits to Attachment C and Large Table 3.</p>



Date: February 13, 2015	NorthMet Project Waste Characterization Data Package
Version: 12	Page 167

## References

1. **Day, S. and Corriveau, M.** Results of Analysis from Overburden Drilling Program - NorthMet Project - DRAFT. [Memorandum to PolyMet and MnDNR]. October 16, 2008. Document ID GC05.
2. **Day, S. and Kearney, C.** Results of Analysis from Overburden Drilling Program - Update for March 2010 Test Pit Program - NorthMet Project - DRAFT. [Memorandum to PolyMet and MnDNR]. August 13, 2010.
3. **SRK Consulting Engineers and Scientists.** RS53/RS42 - Waste Rock Characteristics/Waste Water Quality Modeling - Waste Rock and Lean Ore - NorthMet Project - DRAFT. [RS53/RS42 Draft-01]. March 2007.
4. —. RS82 - Update on Use of Kinetic Test Data for Water Quality Predictions - DRAFT 02. [RS82, Draft-02]. February 2009.
5. **Poly Met Mining Inc.** ER03 - PolyMet NorthMet Geology and Resource Background. [ER03 Draft-01]. March 2007.
6. **Day, S.** RS42 Agency Work Plan Request for Section 1.1 - DRAFT. [Memorandum to PolyMet]. March 31, 2008.
7. **SRK Consulting Engineers and Scientists.** RS54/RS46 - Waste Water Modeling - Tailings - NorthMet Project - DRAFT. [RS54/RS46 Draft-01]. July 2007.
8. **Chapman, J.** PolyMet Mitigation Modeling Assumptions. [Memorandum to Stephen Day, SRK]. June 23, 2009.
9. **Poly Met Mining Inc.** NorthMet Project Project Description (v6). November 2014.
10. —. NorthMet Project Flotation Tailings Management Plan (v4). November 2014.
11. **SRK Consulting Engineers and Scientists.** RS33/RS65 - Hydrometallurgical Residue Characterization and Water Quality Model - NorthMet Project - DRAFT. [RS33/RS65 Draft-01]. February 2007.
12. **Day, S.** Updates to Water Quality Predictions in Support for RS74 - DRAFT 2. [Memorandum to Barr and PolyMet]. September 18, 2008. RS74A Draft-02 Appendix E.
13. **Minnesota Department of Natural Resources, U.S. Army Corps of Engineers, USFS.** Water Resources/Groundwater Impact Assessment Planning Summary Memo. June, 2011.
14. **Poly Met Mining Inc.** NorthMet Project Residue Management Plan (v3). November 2014.

Date: February 13, 2015	NorthMet Project Waste Characterization Data Package
Version: 12	Page 168

15. —. NorthMet Project Water Management Plan - Mine Site (v3). December 2014.
16. **Draper, N.R. and Smith, H.** Applied Regression Analysis. 2nd New York : John Wiley & Sons, 1981.
17. **Lapakko, K. A., Olson, M. C. and Antonson, D. A.** Dissolution of Duluth Complex rock from the Babbitt and Dunka Road Prospects: Eight-year laboratory experiment. [Online] 2013. [http://files.dnr.state.mn.us/lands\\_minerals/reclamation/mndnr\\_dc\\_wasterock\\_2013.pdf](http://files.dnr.state.mn.us/lands_minerals/reclamation/mndnr_dc_wasterock_2013.pdf).
18. **Malmstrom, M.E., et al.** Resolving the Scale-Dependence of Mineral Weathering Rates. *Environmental Science and Technology*. 2000, Vol. 34:7, p. 1375.
19. **Lapakko, K., Antonson, D. and Engstrom, J.** Analytical Screening of Abandoned Waste Rock Piles. [Minnesota Department of Natural Resources, Division of Lands and Minerals]. June 2004.
20. **Day, S.** Supplement to Responses to RS42 Comments - UPDATE. [Memorandum to PolyMet]. September 26, 2007.
21. **Nicholson, R.V. and Sharer, J.M.** Laboratory Studies of Pyrrhotite Oxidation. *Mine Environment Neutral Drainage Program Report 1.21.2*. March 1998.
22. **Hinck, P. and Day, S.** Verification of NorthMet Project Model for the AMAX Piles. [Memorandum to PolyMet]. October 13, 2011.
23. **Lapakko, K. and Antonson, D.** Laboratory Dissolution of Duluth Complex Rock from the Babbitt and Dunka Road Prospects, Status Report. [Minnesota Department of Natural Resources, Division of Lands and Minerals]. October 2006.
24. **Engstrom, J. and Olson, M.** Category 1 Waste Rock Scale-Up Factor. [Agency CDF011]. May 3, 2012.
25. **Minnesota Department of Natural Resources.** Dunka Data Summary: 1976-1993. March 15, 1996.
26. **Engstrom, J.** Concentration Caps for the Category One Waste Rock, PolyMet NorthMet Project. [Memorandum to Larry Kramka, MDNR]. November 21, 2011. Table 1 corrected in email from Zach Wenz, MDNR to Barr on December 8, 2011.
27. **Berndt, M., Lapakko, K. and Jakel, E.** In-Pit Disposal of Taconite Tailings: Geochemistry. St. Paul, MN : Minnesota Department of Natural Resources, Division of Lands and Minerals, 1999.
28. **Barr Engineering Company.** RS29T - Technical Design Evaluation Report, Wastewater Treatment Technology. [RS29T Draft-02]. March 2007.

Date: February 13, 2015	NorthMet Project Waste Characterization Data Package
Version: 12	Page 169

29. **Ferguson, KD and Leask, SM.** The Export of Nutrients from Surface Coal Mines. *Regional Program Report 87-11*. 1988. Environment Canada.
30. **Poly Met Mining Inc.** NorthMet Project Water Modeling Data Package Volume 1 - Mine Site (v13). December 2014.
31. **Weber, J.** Personal communication. Gulliver, Michigan : Carmeuse Limestone, January 25, 2011.
32. **SRK Consulting Engineers and Scientists.** RS31 - Pit Water Quality Model - NorthMet Project - DRAFT. [RS31 Draft-01]. July 2007.
33. **Lienhard, J.H. IV and Lienhard, J.H. V.** *A Heat Transfer Textbook*. Cambridge : Phlogiston Press, 2008.
34. **Baker, D.G., Ruschy, D.L. and Skaggs, R.H.** Climate of Minnesota: Part XVI, Incoming and Reflected Solar Radiation at St. Paul. 1987. Station Bulletin 580-1987, Item AD-SB-3276. Minnesota Agricultural Experiment Station, University of Minnesota.
35. **National Oceanic and Atmospheric Administration.** Local Climatological Data - Annual Summary with Comparative Data. International Falls (INL). [30 Year Normals (1971-2000)]. 2005.
36. **Poly Met Mining Inc.** NorthMet Project Adaptive Water Management Plan (v6). December 2014.
37. **Barr Engineering Company.** Toxicity Identification Evaluation 2010-2011 Study for the Mesabi Nugget Pits. June 2011. Mesabi Nugget Phase I Project.
38. **Day, S.** NorthMet Project Geochemical Uncertainty Analysis for Proposed Action - DRAFT. [Memorandum to PolyMet and Barr]. October 10, 2008.
39. **Morin, KA.** Rates of sulfide oxidation in submerged environments: Implications for subaqueous disposal. *Proceedings of the 17th Annual Mine Reclamation Symposium*. Port Hardy, British Columbia : Mining Association of British Columbia, May 4-7, 1993. pp. 235-247.
40. **Poly Met Mining Inc.** NorthMet Project Water Modeling Data Package Volume 2 - Plant Site (v10). December 2014.
41. **Aubertin, M., Ricard, J. and Chapuis, R.P.** A Predictive Model for the Water Retention Curve: Application to Tailings from Hard-rock Mines. *Canadian Geotechnical Journal*. 1998, Vol. 35, pp. 55-69.



Date: February 13, 2015	NorthMet Project Waste Characterization Data Package
Version: 12	Page 170

42. **Poly Met Mining Inc.** NorthMet Project Geotechnical Data Package Vol 1 - Flotation Tailings Basin (v5). December 2014.

43. **Clesceri, L.S., Greenberg, A.E. and Eaton, A.D., [ed.]**. Standard Methods for the Examination of Water and Wastewater. 20th Washington : APHA, AWWA, WEF, 1998.

44. **Barr Engineering Company**. Tailings Basin - Mitigation Design Water Balance. [RS13B Draft-01]. September 2008.

45. **Mian, M.H. and Yanful, E.K.** Erosion Characteristics and Resuspension of Sub-Aqueous Mine Tailings. *Journal of Environmental Engineering Science*. 2007. Vol. 6, pp. 175-190.



## List of Tables

Table 3-1	95th Percentile Results from Overburden Leaching Tests .....	4
Table 3-2	Comparison of Results from Unsaturated Overburden Leaching Tests.....	5
Table 4-1	2007 95th Percentile Results from Humidity Cell Tests (mg/kg/week) .....	8
Table 4-2	Waste Rock and Ore: 2009 95th Percentile Results from Humidity Cell Tests (mg/kg/week) .....	10
Table 4-3	Maximum Concentrations from Category 1 SMWMP Test .....	14
Table 4-4	Waste Characterization Tests by Rock Type .....	18
Table 5-1	2007 Average Reaction Rate Constants from Humidity Cell Tests.....	31
Table 5-2	2007 Average Release Ratios from Humidity Cell Tests (mol/mol SO <sub>4</sub> )..	32
Table 5-3	2009 Average Reaction Rate Constants from Humidity Cell Tests.....	33
Table 5-4	2009 Average Release Ratios from Humidity Cell Tests (mol/mol SO <sub>4</sub> )..	33
Table 6-1	Maximum Observed Hydrometallurgical Residue Humidity Cell Concentrations.....	43
Table 6-2	Average Observed Hydrometallurgical Residue Humidity Cell Concentrations.....	45
Table 7-1	Distributions for Unsaturated Overburden and Peat Leachate .....	48
Table 8-1	Linear Regression Results for Sulfate Release .....	54
Table 8-2	Deterministic Scale-Up Factor Assumptions .....	67
Table 8-3	Surface Area to Mass Ratio Calculation Example .....	70
Table 8-4	Input Variables for Scale-Up Factor Modeling.....	77
Table 8-5	Results from Monte Carlo Analysis of Bulk Scale-Up Factors.....	77
Table 8-6	AMAX Test Model Results for Sulfate Release .....	80
Table 8-7	MDNR Dunka Stockpile Data used for Scale Factor Analysis .....	82
Table 8-8	Average Metal Content from Aqua Regia Data (ppm).....	94
Table 8-9	Nitrogen Leaching Input Information .....	95
Table 8-10	Nitrogen Leaching Outputs.....	95
Table 8-11	Stockpile Nitrogen Leaching Critical Conditions .....	96
Table 8-12	Scoping Model Inputs for Nitrate .....	97
Table 8-13	Cold Climate Waste Rock Seepage Nitrate Concentrations .....	99
Table 8-14	Estimate of Potential Rail Car Ore Spillage.....	103
Table 9-1	Thermodynamic Input Assumptions .....	110
Table 9-2	Radiation Inflow Data and Calculations .....	111
Table 9-3	Calculated Radiation Outflows and Temperature Changes .....	113
Table 9-4	Nearby Pit Lake Nitrogen Concentrations .....	124



Date: February 13, 2015	NorthMet Project Waste Characterization Data Package
Version: 12	Page 172

Table 9-5	Scoping Model Inputs for Subaqueous Oxidation.....	125
Table 10-1	Input values for the target concentrations and loading from the basin....	136
Table 10-2	Hydraulic Parameter Results from the DBS&A Laboratory Study .....	143
Table 10-3	Coefficients used to Determine Hydraulic Parameters (Eq. 10-17 & 10-18)	144
Table 10-4	Van Genuchten parameters for the bentonite-amended tailings .....	144
Table 10-5	Expected Saturation (%) in the Tailings Layers of the FTB .....	148
Table 10-6	Saturated Hydraulic Conductivity Values for the Existing LTVSMC Tailings.....	151
Table 10-7	Van Genuchten Parameters for the Existing LTVSMC Tailings.....	151
Table 10-8	Nearby Temperature Data (1981 – 2010) and Proposed Distribution Parameters .....	158
Table 10-9	Average Metal Content from Aqua Regia Data (ppm).....	162

## List of Figures

Figure 4-1	Whole Rock Analysis .....	19
Figure 4-2	Drill Core Sulfur Distribution with Samples.....	20
Figure 4-3	Drill Core Sulfur .....	20
Figure 4-4	Drill Core Copper .....	21
Figure 4-5	Drill Core Nickel .....	21
Figure 4-6	Drill Core Cobalt .....	22
Figure 4-7	Drill Core Zinc .....	22
Figure 4-8	Sulfur Content Distribution for Category 1 Waste Rock .....	24
Figure 4-9	Sulfur Content Distribution for Category 2/3 Waste Rock .....	24
Figure 4-10	Sulfur Content Distribution for Category 4 Waste Rock .....	25
Figure 4-11	Wall Rock Category Fractions for the East Pit .....	26
Figure 4-12	Wall Rock Category Fractions for the West Pit.....	26
Figure 4-13	Total Pit Wall Rock Areas .....	27
Figure 4-14	Sulfur Content with Depth for Category 1 Wall Rock .....	28
Figure 4-15	Sulfur Content with Depth for Category 2/3 Wall Rock .....	28
Figure 4-16	Sulfur Content with Depth for Duluth Complex Category 4 Wall Rock ...	29
Figure 4-17	Sulfur Content with Depth for Virginia Formation Category 4 Wall Rock	29
Figure 4-18	Sulfur Content with Depth for Ore Wall Rock.....	30
Figure 5-1	Distribution for the Percent Fines in the Tailings Beaches .....	37
Figure 5-2	Distribution for the Porosity in the Tailings Beaches .....	37
Figure 5-3	Distribution for the Porosity under the Pond .....	38
Figure 5-4	Distribution for the Percent Coarse in the Feed Material.....	38
Figure 8-1	Sulfur Content versus Nonacidic Sulfate Release for Category 1 and 2/3	51
Figure 8-2	Sulfur Content versus Nonacidic Sulfate Release for Duluth Complex (DC) Category 4 and Ore.....	51
Figure 8-3	Sulfur Content versus Nonacidic Sulfate Release for Duluth Complex (DC) Samples with less than 1.5% Sulfur (Outliers Removed).....	52
Figure 8-4	Residuals Testing for the Regression Model for Combined Duluth Complex Data.....	56
Figure 8-5	Weighted Linear Regression Fit for Combined Duluth Complex Data .....	58
Figure 8-6	Normalized Residuals from Weighted Linear Regression Fit .....	58
Figure 8-7	Distribution for the Sulfate Release Slope for Category 1, Category 2/3 and Ore.....	60
Figure 8-8	Distribution for the Water Contact Factor .....	68
Figure 8-9	Distribution for the Particle Size Factor .....	71



Date: February 13, 2015	NorthMet Project Waste Characterization Data Package
Version: 12	Page 174

Figure 8-10	Distribution for the Site Temperature .....	72
Figure 8-11	Distribution for the Activation Energy .....	73
Figure 8-12	Simulated Temperature Factor Distribution.....	73
Figure 8-13	Distributions for the Time to Onset of Acidity .....	76
Figure 8-14	Distribution for the Acidity Factor .....	76
Figure 8-15	Bulk Scale Factor Distributions (nonacidic) .....	78
Figure 8-16	Bulk Scale Factor Distribution (acidic) .....	79
Figure 8-17	MDNR Bulk Scale-up Factor Distribution.....	82
Figure 8-18	Modeled Category 1 Waste Rock pH.....	85
Figure 8-19	Distribution for Category 1 Waste Rock pH.....	86
Figure 8-20	Scoping Model Results for Nitrate in Stockpile Seepage.....	98
Figure 8-21	Scoping Model Results for Nitrate at the Property Boundary .....	99
Figure 8-22	Scoping Model Results for Ammonia at the Property Boundary .....	100
Figure 8-23	Distribution for One-Time Chloride Release .....	105
Figure 9-1	Wall Rock Thickness Distribution.....	107
Figure 9-2	Wall Particle Size Factor Distribution .....	109
Figure 9-3	Envelope of Increased Wall Rock Temperatures due to Radiation .....	114
Figure 9-4	Example Sulfate Decay Relationships .....	116
Figure 9-5	Sulfate Decay in NorthMet Humidity Cells.....	116
Figure 9-6	Sulfate Decay Parameters from MDNR and NorthMet Data .....	117
Figure 9-7	Sulfate Decay Example Simulation (20 realizations).....	119
Figure 9-8	Distribution for Sulfate Decay Parameter $a_1$ .....	120
Figure 9-9	Distribution for Sulfate Decay Parameter $a_0$ .....	121
Figure 10-1	Distribution for the Tailings Lab-to-Field Temperature Factor .....	133
Figure 10-2	Distribution for the Tailings Lab-to-Field Freezing Factor.....	133
Figure 10-3	Distribution for the Tailings Composite Lab-to-Field Scale Factor .....	134
Figure 10-4	Sulfate concentrations of the un-calibrated existing conditions model ...	137
Figure 10-5	Sulfate concentrations of the calibrated existing conditions model .....	138
Figure 10-6	Cobalt concentrations of the un-calibrated existing conditions model....	139
Figure 10-7	Cobalt concentrations of the calibrated existing conditions model .....	140
Figure 10-8	Saturated Hydraulic Conductivity ( $K_{sat}$ ) Surface .....	145
Figure 10-9	Van Genuchten Parameter $\alpha$ Surface .....	145
Figure 10-10	Van Genuchten Parameter $\beta$ Surface .....	146
Figure 10-11	Residual Moisture Content ( $\theta_r$ ) Surface.....	146
Figure 10-12	Example Oxygen Concentration and Sulfate Production Profile.....	153



Date: February 13, 2015	NorthMet Project Waste Characterization Data Package
Version: 12	Page 175

Figure 10-13 Oxygen Profiles at Different  $r/D$  Ratios ..... 154  
 Figure 10-14 Dissolved Oxygen Concentration as a Function of Water Temperature.. 157

**List of Large Tables**

Large Table 1 Summary of NorthMet Project Humidity Cells (Waste Rock)  
 Large Table 2 Proposed Approach for Deriving Non-Acidic Release Rates (Waste Rock)  
 Large Table 3 Stockpile Rock from Block Model Compared to Waste Characterization Tests  
 Large Table 4 Summary of NorthMet Project Humidity Cells (Tailings)  
 Large Table 5 Proposed Approach for Deriving Release Rates (Tailings)  
 Large Table 6 Distribution Parameters for Category 1 Waste Rock Release  
 Large Table 7 Distribution Parameters for Category 2/3 Waste Rock Release  
 Large Table 8 Distribution Parameters for Duluth Complex Category 4 Waste Rock Release  
 Large Table 9 Distribution Parameters for Ore Release  
 Large Table 10 Distribution Parameters for Virginia Formation Category 4 Waste Rock Release  
 Large Table 11 Proposed Approach for Deriving Concentration caps  
 Large Table 12 Distribution Parameters for Category 1 Waste Rock Concentration caps  
 Large Table 13 Distribution Parameters for Duluth Complex Category 2/3, 4 and Ore Concentration caps (nonacidic conditions)  
 Large Table 14 Distribution Parameters for Duluth Complex Category 2/3, 4 and Ore Waste Rock Concentration caps (acidic conditions)  
 Large Table 15 Distribution Parameters for Virginia Formation Category 4 Waste Rock Concentration caps  
 Large Table 16 Distribution Parameters for Flotation Fine Tailings Release  
 Large Table 17 Distribution Parameters for Flotation Coarse Tailings Release  
 Large Table 18 Distribution Parameters for LTVSMC Tailings Release  
 Large Table 19 Distribution Parameters for LTVSMC Tailings Disturbed Flushing Load

### List of Large Figures

- Large Figure 1 Distributions from Humidity Cells for Category 1 Waste Rock (a)
- Large Figure 2 Distributions from Humidity Cells for Category 1 Waste Rock (b)
- Large Figure 3 Distributions from Humidity Cells for Category 1 Waste Rock (c)
- Large Figure 4 Distributions from Humidity Cells for Category 1 Waste Rock (d)
- Large Figure 5 Distributions from Humidity Cells for Category 2/3 Waste Rock and Ore Wall Rock (a)
- Large Figure 6 Distributions from Humidity Cells for Category 2/3 Waste Rock and Ore Wall Rock (b)
- Large Figure 7 Distributions from Humidity Cells for Category 2/3 Waste Rock and Ore Wall Rock (c)
- Large Figure 8 Distributions from Humidity Cells for Category 2/3 Waste Rock and Ore Wall Rock (d)
- Large Figure 9 Distributions from Humidity Cells for Duluth Complex Category 4 Waste Rock (a)
- Large Figure 10 Distributions from Humidity Cells for Duluth Complex Category 4 Waste Rock (b)
- Large Figure 11 Distributions from Humidity Cells for Duluth Complex Category 4 Waste Rock (c)
- Large Figure 12 Distributions from Humidity Cells for Duluth Complex Category 4 Waste Rock (d)
- Large Figure 13 Distributions from Humidity Cells for Ore in Surge Pile (a)
- Large Figure 14 Distributions from Humidity Cells for Ore in Surge Pile (b)
- Large Figure 15 Distributions from Humidity Cells for Ore in Surge Pile (c)
- Large Figure 16 Distributions from Humidity Cells for Ore in Surge Pile (d)
- Large Figure 17 Distributions from Humidity Cells for Virginia Formation Category 4 Waste Rock (a)
- Large Figure 18 Distributions from Humidity Cells for Virginia Formation Category 4 Waste Rock (b)
- Large Figure 19 Distributions from Humidity Cells for Virginia Formation Category 4 Waste Rock (c)
- Large Figure 20 Distributions from Humidity Cells for Virginia Formation Category 4 Waste Rock (d)
- Large Figure 21 Distributions from Microprobe Data for Nickel
- Large Figure 22 Distributions from Microprobe Data for Iron
- Large Figure 23 Category 1 Concentration Cap Function (Co)
- Large Figure 24 Category 1 Concentration Cap Function (Cu)



Date: February 13, 2015	NorthMet Project Waste Characterization Data Package
Version: 12	Page 177

- Large Figure 25 Category 1 Concentration Cap Function (Mn)
- Large Figure 26 Category 1 Concentration Cap Function (Ni)
- Large Figure 27 Category 1 Concentration Cap Function (Zn)
- Large Figure 28 Distributions for Duluth Complex Category 2/3, 4 and Ore Concentration caps (nonacidic conditions) (a)
- Large Figure 29 Distributions for Duluth Complex Category 2/3, 4 and Ore Concentration caps (nonacidic conditions) (b)
- Large Figure 30 Distributions for Duluth Complex Category 2/3, 4 and Ore Concentration caps (nonacidic conditions) (c)
- Large Figure 31 Distributions for Duluth Complex Category 2/3, 4 and Ore Concentration caps (nonacidic conditions) (d)
- Large Figure 32 Distributions for Duluth Complex Category 2/3, 4 and Ore Concentration caps (acidic conditions) (a)
- Large Figure 33 Distributions for Duluth Complex Category 2/3, 4 and Ore Concentration caps (acidic conditions) (b)
- Large Figure 34 Distributions for Duluth Complex Category 2/3, 4 and Ore Concentration caps (acidic conditions) (c)
- Large Figure 35 Distributions for Duluth Complex Category 2/3, 4 and Ore Concentration caps (acidic conditions) (d)
- Large Figure 36 Distributions for Duluth Complex Category 2/3, 4 and Ore Concentration caps (acidic conditions) (e)
- Large Figure 37 Distributions for Virginia Formation Category 4 Concentration caps (a)
- Large Figure 38 Distributions for Virginia Formation Category 4 Concentration caps (b)
- Large Figure 39 Distributions for Virginia Formation Category 4 Concentration caps (c)
- Large Figure 40 Distributions for Virginia Formation Category 4 Concentration caps (d)
- Large Figure 41 Distributions for Virginia Formation Category 4 Concentration caps (e)
- Large Figure 42 Distributions for Flotation Fine Tailings Release (a)
- Large Figure 43 Distributions for Flotation Fine Tailings Release (b)
- Large Figure 44 Distributions for Flotation Fine Tailings Release (c)
- Large Figure 45 Distributions for Flotation Fine Tailings Release (d)
- Large Figure 46 Distributions for Flotation Coarse Tailings Release (a)
- Large Figure 47 Distributions for Flotation Coarse Tailings Release (b)
- Large Figure 48 Distributions for Flotation Coarse Tailings Release (c)
- Large Figure 49 Distributions for Flotation Coarse Tailings Release (d)
- Large Figure 50 Distributions for LTVSMC Tailings Release (a)
- Large Figure 51 Distributions for LTVSMC Tailings Release (b)
- Large Figure 52 Distributions for LTVSMC Tailings Release (c)



Date: February 13, 2015	NorthMet Project Waste Characterization Data Package
Version: 12	Page 178

- Large Figure 53 Distributions for LTVSMC Tailings Concentration-Capped Release (a)
- Large Figure 54 Distributions for LTVSMC Tailings Concentration-Capped Release (b)
- Large Figure 55 Distributions for LTVSMC Tailings Concentration-Capped Release (c)
- Large Figure 56 Distributions for LTVSMC Disturbed Flushing Load (a)
- Large Figure 57 Distributions for LTVSMC Disturbed Flushing Load (b)
- Large Figure 58 Distributions for LTVSMC Disturbed Flushing Load (c)
- Large Figure 59 Distributions for LTVSMC Disturbed Flushing Load (d)
- Large Figure 60 Distributions for LTVSMC Disturbed Flushing Load (e)

### **List of Attachments**

- Attachment A Water Quality Modeling for Waste Rock and Pit Walls
- Attachment B Results of an Experiment to Evaluate Solubility Limits for Category 1 Waste Rock
- Attachment C 2015 Update on Kinetic Test Data
- Attachment D 2014 Update on Kinetic Test Data
- Attachment E Physical Model Study of Fine-Grained Tailings Delta Formation under Various Flow Conditions: Project Report
- Attachment F Update on Tailings Humidity Cell Test Data
- Attachment G Laboratory Report for Barr Engineering Company (Tailings Samples)



## Large Tables

Large Table 1 Summary of NorthMet Project Humidity Cells (Waste Rock)

Rock Type	Waste Category	Sample ID	Sulfur (%)	Condition 1 Start (weeks)	Condition 2 Start (weeks)	Condition 3 Start (weeks)	Condition 4 Start (weeks)	Total Duration (weeks)
Anorthositic	1	99-320C(830-850)	0.09	4	179	-	-	436
Anorthositic	1	00-361C(345-350)	0.05	6	184	-	-	436
Anorthositic	1	00-366C(185-205)	0.02	0	-	-	-	198
Anorthositic	1	00-366C(230-240)	0.02	4	60	-	-	198
Anorthositic	1	99-320C(165-175)	0.03	0	72	-	-	198
Anorthositic	1	00-334C(30-50)	0.02	4	-	-	-	436
Anorthositic	1	00-368C(125-145)	0.04	0	80	-	-	436
Anorthositic	1	00-368C(20-40)	0.04	0	80	-	-	198
Troctolitic	1	00-340C(595-615)	0.04	0	-	-	-	198
Troctolitic	1	00-334C(580-600)	0.06	1	179	-	-	436
Troctolitic	1	00-334C(640-660)	0.07	12	224	-	-	436
Troctolitic	1	00-347C(795-815)	0.07	0	103	-	-	198
Troctolitic	1	99-318C(250-270)	0.04	0	72	-	-	198
Troctolitic	1	00-373C(95-115)	0.04	0	-	-	-	198
Troctolitic	1	00-373C(75-95)	0.06	0	-	-	-	198
Troctolitic	1	00-357C(110-130)	0.08	10	-	-	-	198
Troctolitic	1	99-320C(315-330)	0.07	4	72	-	-	436
Troctolitic	1	00-366C(35-55)	0.02	0	-	-	-	198
Troctolitic	1	00-334C(110-130)	0.04	0	-	-	-	198
Troctolitic	1	00-347C(155-175)	0.06	0	72	-	-	198
Troctolitic	1	00-347C(280-300)	0.06	16	65	-	-	198
Troctolitic	1	00-367C(50-65)	0.03	0	-	-	-	198
Troctolitic	1	00-367C(260-280)	0.04	0	-	-	-	198
Troctolitic	1	00-367C(290-310)	0.04	0	-	-	-	436
Troctolitic	1	00-370C(20-30)	0.08	10	-	-	-	198
Troctolitic	1	26064(44-54)	0.02	0	-	-	-	436
Troctolitic	1	26064(264+146269+156)	0.06	4	-	-	-	436
Troctolitic	1	26056(110-125)	0.04	0	-	-	-	198
Troctolitic	1	26029(815-825)	0.02	0	-	-	-	194
Troctolitic	1	26056(135-153)	0.05	0	-	-	-	430
Troctolitic	1	00-326C(250-265)	0.08	4	-	-	-	186
Ultramafic	1	00-357C(335-340)	0.08	12	187	-	-	198
Ultramafic	1	00-368C(460-465)	0.06	0	-	-	-	198
Ultramafic	1	26055(940-945)	0.06	16	-	-	-	198
Ultramafic	1	26098+00-337C	0.1	0	-	-	-	198
Ultramafic	1	00-361C(240-245)	0.06	14	184	-	-	436
Ultramafic	1	26039(310-315)	0.06	8	-	-	-	186
Ultramafic	1	00-326C(225-235)	0.12	8	-	-	-	425
Anorthositic	2/3	00-361C(310-320)	0.18	0	111	-	-	436
Anorthositic	2/3	99-320C(400-405)	0.18	14	-	-	-	425
Sedimentary Hornfels	2/3	26030(1047-1052)	0.24	53	-	-	-	436
Sedimentary Hornfels	2/3	26061(1218-1233)	0.44	4	-	-	-	436
Sedimentary Hornfels	2/3	00-340C(990-995)	0.55	0	189	-	-	436
Troctolitic	2/3	00-350C(580-600)	0.19	0	196	-	-	436
Troctolitic	2/3	00-327C(225-245)	0.44	0	182	-	-	198
Troctolitic	2/3	00-369C(335-345)	0.18	4	181	-	-	436
Troctolitic	2/3	00-326C(60-70)	0.14	0	75	164	-	436
Troctolitic	2/3	00-369C(305-325)	0.25	4	187	-	-	436
Troctolitic	2/3	00-369C(20-30)	0.21	0	187	-	-	436
Troctolitic	2/3	00-367C(170-175)	0.51	0	172	-	-	436
Troctolitic	2/3	00-340C(380-390)	0.15	4	-	-	-	198
Troctolitic	2/3	26049+26030	0.59	4	-	-	-	198
Troctolitic	2/3	26056(302-312)	0.23	12	212	-	-	436
Troctolitic	2/3	26142(360+345-365+350)	0.18	0	168	-	-	436
Troctolitic	2/3	99-318C(325-330)	0.17	0	180	-	-	425
Troctolitic	2/3	26056(282-292)	0.32	2	178	-	-	186
<b>Troctolitic</b>	<b>2/3</b>	<b>00-340C(910-925)</b>	<b>0.36</b>	<b>0</b>	<b>72</b>	<b>110</b>	<b>180</b>	<b>425</b>
<b>Troctolitic</b>	<b>2/3</b>	<b>00-331C(190-210)</b>	<b>0.42</b>	<b>0</b>	<b>48</b>	<b>201</b>	<b>229</b>	<b>425</b>
Troctolitic	2/3	00-367C(495-500)	0.28	8	114	-	-	425
Ultramafic	2/3	00-326C(680-685)	0.3	0	69	-	-	198
Ultramafic	2/3	00-357C(535-540)	0.2	0	78	194	194	436
<b>Ultramafic</b>	<b>2/3</b>	<b>00-344C(630-635)</b>	<b>0.34</b>	<b>0</b>	<b>51</b>	<b>160</b>	<b>-</b>	<b>186</b>
Ultramafic	2/3	00-326C(495-505)	0.16	0	-	-	-	186
Anorthositic	4	00-343C(240-250)	0.68	0	161	-	-	198
<b>Anorthositic***</b>	<b>4</b>	<b>26027(616-626)***</b>	<b>1.83</b>	<b>4</b>	<b>18</b>	<b>24</b>	<b>-</b>	<b>436</b>
<b>Anorthositic***</b>	<b>4</b>	<b>00-331C(255-260)***</b>	<b>0.86</b>	<b>0</b>	<b>19</b>	<b>162</b>	<b>184</b>	<b>425</b>
<b>Sedimentary Hornfels</b>	<b>4</b>	<b>00-340C(965-974.5)</b>	<b>1.74</b>	<b>0</b>	<b>25</b>	<b>34</b>	<b>80</b>	<b>198</b>
<b>Sedimentary Hornfels</b>	<b>4</b>	<b>26043+26027</b>	<b>2.47</b>	<b>0</b>	<b>9</b>	<b>26</b>	<b>48</b>	<b>436</b>
Sedimentary Hornfels	4	26062+26026	4.46	0	3	3	-	438
Sedimentary Hornfels	4	26058(704-715)	1.46	8	41	-	-	427
<b>Troctolitic***</b>	<b>4</b>	<b>00-371C(435-440)***</b>	<b>0.88</b>	<b>0</b>	<b>51</b>	<b>90</b>	<b>196</b>	<b>436</b>
<b>Troctolitic***</b>	<b>4</b>	<b>00-340C(765-780)***</b>	<b>1.68</b>	<b>0</b>	<b>61</b>	<b>82</b>	<b>200</b>	<b>436</b>
Troctolitic	4	00-367C(395-400)	0.77	0	82	-	-	198
Troctolitic	4	00-340C(725-745)	0.91	6	118	-	-	198
<b>Troctolitic</b>	<b>4</b>	<b>00-367C(400-405)</b>	<b>1.37</b>	<b>4</b>	<b>39</b>	<b>78</b>	<b>-</b>	<b>198</b>
Ultramafic	4	99-318C(725-735)	0.72	0	96	-	-	198
Ultramafic	4	99-317C(460-470)	1.24	0	39	-	-	198
<b>Ultramafic</b>	<b>4</b>	<b>00-344C(515-520)</b>	<b>1.2</b>	<b>4</b>	<b>47</b>	<b>152</b>	<b>-</b>	<b>198</b>
Ultramafic	4	00-330C(275-280)	0.75	0	164	-	-	186
Virginia	4	00-361C(737-749)	2	0	39	164	194	436
Virginia	4	00-364C(210-229)	3.79	0	0	5	-	436
Virginia	4	00-337C(510-520)	5.68	0	0	5	-	198
Ore Composite	4	P10	0.86	4	88	-	-	432
Ore Composite	4	P20	0.9	6	88	-	-	434
Ore Composite	4	P30	0.86	6	88	-	-	432

Notes

- Time periods as of December 20, 2013. "--" indicates condition not observed.
- Condition 1: relatively stable sulfate release, leachate pH above about 7
- Condition 2: relatively stable sulfate release, leachate pH below about 7 and nickel release unstable and typically increasing (i.e., neutral conditions)
- Condition 3: sulfate release increasing and variable, pH decreasing
- Condition 4: sulfate release decreasing following peak, acidic pH
- Humidity cells in **bold** are used to develop the acidity factor in Section 8.2.5
- Humidity cells marked with (\*\*\*) are used to develop decay relationships in Section 9.4. Although several cells had not reached Condition 4 as of February 24, 2011, decay relationships were evident in further analysis as of July 2011.

**Large Table 2 Proposed Approach for Deriving Non-Acidic Release Rates (Waste Rock)**

Constituent	Goldschmidt Classification	Duluth Complex Category 1				Duluth Complex Category 2/3, 4 and Ore				Virginia Formation Category 4			
		Mineral Sources	Ion	Method	Source	Mineral Sources	Ion	Method	Source	Mineral Sources	Ion	Method	Source
<b>Primary Ions</b>													
SO <sub>4</sub>	Chalcophile	Chalcopyrite > pyrrhotite	SO <sub>4</sub> <sup>2-</sup>	SO <sub>4</sub> Rate	HCT	Pyrrhotite > chalcopyrite > pentlandite	SO <sub>4</sub> <sup>2-</sup>	SO <sub>4</sub> Rate	HCT	Pyrrhotite	SO <sub>4</sub> <sup>2-</sup>	SO <sub>4</sub> Rate	HCT
Alkalinity	Atmophile	Calcite, dolomite	CO <sub>3</sub> <sup>2-</sup>	Alkalinity Rate	HCT	Calcite, dolomite	CO <sub>3</sub> <sup>2-</sup>	Alkalinity Rate	HCT	None	CO <sub>3</sub> <sup>2-</sup>	None	--
Ca	Lithophile	Anorthite, calcite	Ca <sup>2+</sup>	Ca Rate	HCT	Anorthite, calcite	Ca <sup>2+</sup>	Ca/SO <sub>4</sub> Rate, Condition 2	HCT	Anorthite	Ca <sup>2+</sup>	Ca/SO <sub>4</sub> Rate, Condition 3	HCT
Cl	Nonmetallic	Unknown	Cl <sup>-</sup>	First flush release	HCT	Unknown	Cl <sup>-</sup>	First flush release	HCT	Unknown	Cl <sup>-</sup>	First flush release	HCT
Mg	Lithophile	Olivine	Mg <sup>2+</sup>	Mg Rate	HCT	Olivine	Mg <sup>2+</sup>	Mg/SO <sub>4</sub> Rate, Condition 2	HCT	Mg silicates	Mg <sup>2+</sup>	Mg/SO <sub>4</sub> Rate, Condition 3	HCT
Na	Lithophile	Albite	Na <sup>+</sup>	Na Rate	HCT	Albite	Na <sup>+</sup>	Na/SO <sub>4</sub> Rate, Condition 2	HCT	Albite	Na <sup>+</sup>	Na/SO <sub>4</sub> Rate, Condition 3	HCT
K	Lithophile	Biotite	K <sup>+</sup>	K Rate	HCT	Biotite	K <sup>+</sup>	K/SO <sub>4</sub> Rate, Condition 2	HCT	Biotite	K <sup>+</sup>	K/SO <sub>4</sub> Rate, Condition 3	HCT
K	Lithophile	Biotite	K <sup>+</sup>	K Rate	HCT	Biotite	K <sup>+</sup>	K/SO <sub>4</sub> Rate, Condition 3	HCT	Biotite	K <sup>+</sup>	K/SO <sub>4</sub> Rate, Condition 4	HCT
<b>Secondary Ions</b>													
Ag	Chalcophile	Sulfide	Ag <sup>+</sup>	Ag rate	HCT	Sulfide	Ag <sup>+</sup>	Ag/S	Aqua Regia	Sulfide	Ag <sup>+</sup>	Ag/S	Aqua Regia
Al	Lithophile	Anorthite, albite	Al <sup>3+</sup>	Al/Ca (anorthite) + Al/Na (albite)	Mineral formulae	Anorthite, albite	Al <sup>3+</sup>	Al/Ca (anorthite) + Al/Na (albite)	Mineral formulae	Anorthite, albite	Al <sup>3+</sup>	Al/Ca (anorthite) + Al/Na (albite)	Mineral formulae
As	Chalcophile	Sulfide	HAsO <sub>4</sub> <sup>2-</sup>	As rate	HCT	Sulfide	HAsO <sub>4</sub> <sup>2-</sup> / H <sub>2</sub> AsO <sub>4</sub> <sup>-</sup>	As/S	Aqua Regia	Sulfide	HAsO <sub>4</sub> <sup>2-</sup> / H <sub>2</sub> AsO <sub>4</sub> <sup>-</sup>	As/S	Aqua Regia
B	Lithophile	Unknown	H <sub>3</sub> BO <sub>3</sub>	B Rate	HCT	Unknown	H <sub>3</sub> BO <sub>3</sub>	B Rate	HCT	Unknown	H <sub>3</sub> BO <sub>3</sub>	B Rate	HCT
Ba	Lithophile	Biotite	Ba <sup>2+</sup>	Ba/K Ratio	Aqua Regia	Biotite	Ba <sup>2+</sup>	Ba/K Ratio	Aqua Regia	Biotite	Ba <sup>2+</sup>	Ba/K Ratio	Aqua Regia
Be	Lithophile	Biotite	Be <sup>2+</sup>	Be rate	HCT	Biotite	Be <sup>2+</sup>	Be/K Ratio	Aqua Regia	Unknown	Be <sup>2+</sup>	Be/K Ratio	Aqua Regia
Cd	Chalcophile	Sulfide	Cd <sup>2+</sup>	Cd/Zn Rate, Condition 2	HCT	Sulfide	Cd <sup>2+</sup>	Cd/Zn Rate, Condition 2	HCT	Pyrrhotite	Cd <sup>2+</sup>	Cd/S	Aqua Regia
Co	Siderophile	Olivine	Co <sup>2+</sup>	Co/Ni Rate, Condition 2	HCT	Olivine	Co <sup>2+</sup>	Co/Ni Rate, Condition 2	HCT	Pyrrhotite	Co <sup>2+</sup>	Co/S	Aqua Regia
Cr	Lithophile	Unknown	CrOH <sup>2+</sup>	Cr Rate	HCT	Unknown	CrOH <sup>2+</sup>	Cr Rate	HCT	Unknown	CrOH <sup>2+</sup>	Cr Rate	HCT
Cu	Chalcophile	Chalcopyrite	Cu <sup>2+</sup>	Cu/S	Aqua Regia	Chalcopyrite	Cu <sup>2+</sup>	Cu/S	Aqua Regia	Pyrrhotite	Cu <sup>2+</sup>	Cu/S	Aqua Regia
F	Lithophile	Apatite	F <sup>-</sup>	F rate	HCT	Apatite	F <sup>-</sup>	F rate	HCT	Apatite	F <sup>-</sup>	F rate	HCT
Fe	Siderophile	Sulfides, silicates	Fe <sup>3+</sup>	Fe/S (pyrrhotite) + Fe/Mg (olivine)	Microprobe	Sulfides, silicates	Fe <sup>3+</sup>	Fe/S (pyrrhotite) + Fe/Mg (olivine)	Microprobe	Sulfides	Fe <sup>3+</sup>	Fe/SO <sub>4</sub> Rate	HCT
Mn	Siderophile	Sulfide	Mn <sup>2+</sup>	Mn/SO <sub>4</sub> Rate, Condition 2	HCT	Sulfide	Mn <sup>2+</sup>	Mn/SO <sub>4</sub> Rate, Condition 2	HCT	Pyrrhotite	Mn <sup>2+</sup>	Mn Rate	HCT
Ni	Siderophile	Sulfides, olivine	Ni <sup>2+</sup>	Ni/S (Cat 4) + Ni/Mg (olivine)	Aqua Regia Microprobe	Sulfides, olivine	Ni <sup>2+</sup>	Ni/S (Cat 4 or ore) + Ni/Mg (olivine)	Aqua Regia Microprobe	Pyrrhotite	Ni <sup>2+</sup>	Ni/S	Aqua Regia
Pb	Chalcophile	Sulfide	Pb <sup>2+</sup>	Pb rate	HCT	Sulfide	Pb <sup>2+</sup>	Pb/S	Aqua Regia	Pyrrhotite	Pb <sup>2+</sup>	Pb/S	Aqua Regia
Sb	Chalcophile	Sulfide	Oxyanion	Sb rate	Reactor	Sulfide	Oxyanion	Sb/S	Aqua Regia	Pyrrhotite	Oxyanion	Sb/S	Aqua Regia
Se	Chalcophile	Chalcopyrite	SeO <sub>4</sub> <sup>2-</sup>	Se/SO <sub>4</sub> Rate, Condition 2	HCT	Chalcopyrite	SeO <sub>4</sub> <sup>2-</sup>	Se/SO <sub>4</sub> Rate, Condition 2	HCT	Pyrrhotite	SeO <sub>4</sub> <sup>2-</sup>	Se/SO <sub>4</sub> Rate, Condition 2	HCT
Tl	Chalcophile	Unknown	Tl <sup>+</sup>	Tl Rate	HCT	Unknown	Tl <sup>+</sup>	Tl Rate	HCT	Pyrrhotite	Tl <sup>+</sup>	Tl Rate	HCT
V	Lithophile	Biotite	VO <sub>2</sub> (OH) <sup>2-</sup>	V rate	HCT	Biotite	VO <sub>2</sub> (OH) <sup>2-</sup>	V/K	Aqua Regia	Biotite	VO <sub>2</sub> <sup>+</sup>	V/K	Aqua Regia
Zn	Chalcophile	Olivine	Zn <sup>2+</sup>	Zn/Mg	Aqua Regia	Pyrrhotite, olivine	Zn <sup>2+</sup>	Zn/Ni Rate, Condition 2	Aqua Regia	Pyrrhotite	Zn <sup>2+</sup>	Zn/S	Aqua Regia

**Notes**

- "Rate" indicates a release rate developed from humidity cells for primary ions or non-correlated metals, or a ratio of release rates used to estimate metal release from other release rates (ex. Cd/Zn Rate for Category 1). For Sb only the smaller MDNR-style reactors were used to estimate a release rate for Category 1 waste rock.
- Metal ratios with a data source of "Aqua Regia" or "Microprobe" indicate a solids ratio that is used to estimate metal release from the primary ion release rates)
- "Condition 2" refers to a time period in the humidity cells with relatively stable sulfate release, leachate pH below about 7 and nickel release unstable and typically increasing (i.e., neutral conditions, see Large Table 1)
- Acidic release rates will be determined as described in Section 8.1. For humidity cell release rates or release ratios not linked to SO<sub>4</sub>, acidic release rates will be determined based on Condition 3 for the Duluth Complex Category 2/3/4 and Ore.
- For nickel, S ratio from Duluth Complex Category 4 and ore aqua regia data represents the effect of all sulfide minerals combined. See example calculation in Section 8.1.2.3.

**Large Table 3      Stockpile Rock from Block Model Compared to Waste Characterization Tests**

Category	Unit	Block Model Proposed Total Waste Rock					Waste Characterization Tests Drill Cores Within Preliminary Pit Shell				
		Tons*	% of Rock	Minimum %S	Average %S	Maximum %S	Samples	% of Samples	Minimum %S	Average %S	Maximum %S
Category 1	1	1,153,645	0.37%	0.06	0.1	0.12	10	11.24%	0.02	0.07	0.09
Category 1	2 <sup>+</sup>	110,439,546	35.84%	0.01	0.07	0.12	15	16.85%	0.02	0.06	0.12
Category 1	3 <sup>+</sup>						8	8.99%	0.02	0.04	0.06
Category 1	4 <sup>+</sup>	46,077,080	14.95%	0.01	0.06	0.12	5	5.62%	0.03	0.05	0.08
Category 1	5 <sup>+</sup>						2	2.25%	0.02	0.04	0.06
Category 1	6	38,800,965	12.59%	0.01	0.05	0.12	2	2.25%	0.04	0.05	0.05
Category 1	7	20,223,481	6.56%	0.02	0.06	0.12					
Total Category 1		216,694,717	70.33%		0.06		42	47.19%		0.05	
Category 2/3	1	9,355,612	3.04%	0.13	0.32	0.6	13	14.61%	0.16	0.31	0.55
Category 2/3	2 <sup>+</sup>	44,659,052	14.49%	0.13	0.19	0.6	3	3.37%	0.15	0.17	0.18
Category 2/3	3 <sup>+</sup>						5	5.62%	0.14	0.30	0.59
Category 2/3	4 <sup>+</sup>	23,807,049	7.73%	0.13	0.2	0.6	2	2.25%	0.21	0.36	0.51
Category 2/3	5 <sup>+</sup>						2	2.25%	0.23	0.28	0.32
Category 2/3	6	2,558,344	0.83%	0.13	0.17	0.51	1	1.12%	0.18	0.18	0.18
Category 2/3	7	2,402,286	0.78%	0.13	0.17	0.46					
Total Category 2/3		82,782,343	26.87%		0.21		26	29.21%		0.05	
Category 4	1	1,111,358	0.36%	0.61	0.85	2.31	15	16.85%	0.68	1.50	4.46
Category 4	3 <sup>+</sup>	1,872,851	0.61%	0.61	0.99	3.04					
Category 4	4 <sup>+</sup>	94,604	0.03%	0.62	0.81	1.14	2	2.25%	0.77	1.07	1.37
Category 4	5 <sup>+</sup>										
Category 4	6	4	≈0.00%	0.65	0.65	0.65					
Category 4	VF	5,557,813	1.80%	0.34	2.43	4.94	4	4.49%	2.00	3.82	5.68
Total Category 4		8,636,630	2.80%		1.90		21	23.60%		1.90	
Total All Categories		308,113,690			0.15		89				

Notes

\* Total of rock to stockpiles and East Pit

\* Units 2 and 3 are combined and Units 4 and 5 are combined in the Block Model

**Large Table 4 Summary of NorthMet Project Humidity Cells (Tailings)**

<i>Tailings Portion</i>	<i>Tailings Source</i>	<i>Size (Mesh)</i>	<i>HCT ID</i>	<i>Sulfur (%)</i>	<i>Total Duration (weeks)</i>
Fine	Parcel 1-2	< #200	T10	0.09	413
Fine	Parcel 3	< #200	T13	0.14	413
Fine	Pilot Plant 2	< #200	T55	0.09	276
Fine	Pilot Plant 3	< #200	T59	0.08	288
Fine	SCAV	< #200	T63	0.11	216
Fine	SCAV	< #200	T67	0.14	216
Fine	SCAV	< #200	T71	0.13	216
Coarse	Parcel 1-2	#200 - #100	T9	0.1	413
Coarse	Parcel 3	#200 - #100	T12	0.14	413
Coarse	Pilot Plant 2	#200 - #100	T54	0.06	288
Coarse	Pilot Plant 3	#200 - #100	T58	0.08	288
Coarse	SCAV	#200 - #100	T62	0.09	216
Coarse	SCAV	#200 - #100	T66	0.14	216
Coarse	SCAV	#200 - #100	T70	0.1	216
Coarse	Parcel 1-2	> #100	T8	0.11	413
Coarse	Parcel 3	> #100	T11	0.11	413
Coarse	Pilot Plant 2	> #100	T53	0.08	288
Coarse	Pilot Plant 3	> #100	T57	0.1	288
Coarse	SCAV	> #100	T61	0.1	216
Coarse	SCAV	> #100	T65	0.11	216
Coarse	SCAV	> #100	T69	0.1	216
LTVSMC	2E North Embankment	Whole LTVSMC	T73	0.03	181
LTVSMC	1E/2E Separator	Whole LTVSMC	T75	0.04	181
LTVSMC	1E South Beach	Whole LTVSMC	T76	0.01	181
LTVSMC	2W North Embankment	Whole LTVSMC	T77	0.06	181

Notes

- Time periods as of January 17, 2014.
- All Flotation Tailings samples included the use of CuSO<sub>4</sub> in the pilot plant processing
- All humidity cells referenced here were conducted according to ASTM methods
- Material retained on mesh #100 (previously referred to as “coarse”) and material passing mesh #100 but retained on mesh #200 (previously referred to as “mid”) are collectively considered as coarse material (retained on mesh #200) according to the modeling methodology described in Section 5.1.3.1

**Large Table 5 Proposed Approach for Deriving Release Rates (Tailings)**

Constituent	Goldschmidt Classification	Flotation Tailings (Coarse and Fine)				LTVSMC Tailings (Whole)			
		Mineral Sources	Ion	Method	Source	Mineral Sources	Ion	Method	Source
<b>Primary Ions</b>									
SO <sub>4</sub>	Chalcophile	Chalcopyrite > pyrrhotite	SO <sub>4</sub> <sup>2-</sup>	SO <sub>4</sub> Rate	Tailings HCT	Pyrite	SO <sub>4</sub> <sup>2-</sup>	SO <sub>4</sub> Rate	Tailings HCT
Alkalinity	Atmophile	Calcite, dolomite	CO <sub>3</sub> <sup>2-</sup>	CaCO <sub>3</sub> control at atmospheric PCO <sub>2</sub>	Solubility Model	Carbonate Minerals	CO <sub>3</sub> <sup>2-</sup>	CaCO <sub>3</sub> control at atmospheric PCO <sub>2</sub>	Solubility Model
Ca	Lithophile	Anorthite, calcite	Ca <sup>2+</sup>	Ca/Na Rate	Tailings HCT	Carbonate Minerals	Ca <sup>2+</sup>	Concentration capped	Observed Seepage
Cl	Nonmetallic	Unknown	Cl <sup>-</sup>	No release	None	Unknown	Cl <sup>-</sup>	Concentration capped	Observed Seepage
Mg	Lithophile	Olivine	Mg <sup>2+</sup>	Mg/SO <sub>4</sub> Rate	Tailings HCT	Carbonate Minerals	Mg <sup>2+</sup>	Mg/Ca Ratio	Observed Seepage
Na	Lithophile	Albite	Na <sup>+</sup>	Na/SO <sub>4</sub> Rate	Tailings HCT	Albite	Na <sup>+</sup>	Concentration capped	Observed Seepage
K	Lithophile	Biotite	K <sup>+</sup>	K/SO <sub>4</sub> Rate	Tailings HCT	Mica	K <sup>+</sup>	Concentration capped	Observed Seepage
<b>Secondary Ions</b>									
Ag	Chalcophile	Sulfide	Ag <sup>+</sup>	Ag/S	Aqua Regia	Pyrite	Ag <sup>+</sup>	Ag/S	Aqua Regia
Al	Lithophile	Anorthite, albite	Al <sup>3+</sup>	Al/Ca (anorthite) + Al/Na (albite)	Mineral formulae	Feldspar	Al <sup>3+</sup>	Concentration capped	Observed Seepage
As	Chalcophile	Sulfide	HAsO <sub>4</sub> <sup>2-</sup> /H <sub>2</sub> AsO <sub>4</sub> <sup>-</sup>	As/S	Aqua Regia	Pyrite	HAsO <sub>4</sub> <sup>2-</sup> /H <sub>2</sub> AsO <sub>4</sub> <sup>-</sup>	As/S	Aqua Regia
B	Lithophile	Unknown	H <sub>3</sub> BO <sub>3</sub>	Solubility control	Defined concentration cap	Unknown	H <sub>3</sub> BO <sub>3</sub>	Concentration capped	Observed Seepage
Ba	Lithophile	Biotite	Ba <sup>2+</sup>	Ba/K Ratio	Aqua Regia	Mica	Ba <sup>2+</sup>	BaSO <sub>4</sub> control	Solubility Model
Be	Lithophile	Biotite	Be <sup>2+</sup>	Be/K Ratio	Aqua Regia	Mica	Be <sup>2+</sup>	Concentration capped	Observed Seepage
Cd	Chalcophile	Sulfide	Cd <sup>2+</sup>	Cd/Zn Rate, Condition 2	Cat 2/3 Waste Rock HCT	Pyrite	Cd <sup>2+</sup>	Cd/S	Aqua Regia
Co	Siderophile	Olivine	Co <sup>2+</sup>	Co/Ni Rate, Condition 2	Cat 2/3 Waste Rock HCT	Pyrite	Co <sup>2+</sup>	Co/S	Aqua Regia
Cr	Lithophile	Unknown	CrOH <sup>2+</sup>	Solubility control	Defined concentration cap	Unknown	CrOH <sup>2+</sup>	Concentration capped	Observed Seepage
Cu	Chalcophile	Chalcopyrite	Cu <sup>2+</sup>	Cu/S	Aqua Regia	Chalcopyrite	Cu <sup>2+</sup>	Cu/S	Aqua Regia
F	Lithophile	Apatite	F <sup>-</sup>	CaF <sub>2</sub> control	Solubility Model	Apatite	F <sup>-</sup>	CaF <sub>2</sub> control	Solubility Model
Fe	Siderophile	Sulfides, silicates	Fe <sup>3+</sup>	Fe/S (pyrrhotite) + Fe/Mg (olivine)	Microprobe	Pyrite, carbonates	Fe <sup>3+</sup>	Fe/S (pyrite)	Microprobe
Mn	Siderophile	Sulfide	Mn <sup>2+</sup>	Mn/Ni Rate	Tailings HCT	Pyrite	Mn <sup>2+</sup>	Concentration capped	Observed Seepage
Ni	Siderophile	Sulfides / olivine	Ni <sup>2+</sup>	Ni/S (pyrrhotite)	Microprobe	Pyrite	Ni <sup>2+</sup>	Ni/S	Aqua Regia
Pb	Chalcophile	Sulfide	Pb <sup>2+</sup>	Pb/S	Aqua Regia	Pyrite	Pb <sup>2+</sup>	Pb/S	Aqua Regia
Sb	Chalcophile	Sulfide	Oxyanion	Sb/S	Aqua Regia	Pyrite	Oxyanion	Sb/S	Aqua Regia
Se	Chalcophile	Chalcopyrite	SeO <sub>4</sub> <sup>2-</sup>	Se/SO <sub>4</sub> Rate	Tailings HCT	Pyrite	SeO <sub>4</sub> <sup>2-</sup>	Se/SO <sub>4</sub> Rate	Tailings HCT
Tl	Chalcophile	Unknown	Tl <sup>+</sup>	Tl/S	Aqua Regia	Pyrite	Tl <sup>+</sup>	Tl/S	Aqua Regia
V	Lithophile	Biotite	VO <sub>2</sub> (OH) <sup>2-</sup>	V/K	Aqua Regia	Mica	VO <sub>2</sub> <sup>+</sup>	Concentration capped	Observed Seepage
Zn	Chalcophile	Olivine	Zn <sup>2+</sup>	Zn/Ni Rate, Condition 2	Cat 2/3 Waste Rock HCT	Pyrite	Zn <sup>2+</sup>	Zn/SO <sub>4</sub> Rate	Tailings HCT

**Notes**

- "Rate" indicates a release rate developed from humidity cells for primary ions or a ratio of release rates used to estimate metal release from other release rates (ex. Mn/Ni Rate for NorthMet tailings)
- Metal ratios with a data source of "Aqua Regia" or "Microprobe" indicate a solids ratio that is used to estimate metal release from the primary ion release rates
- "Condition 2" refers to a time period in the waste rock humidity cells with relatively stable sulfate release, leachate pH below about 7 and nickel release unstable and typically increasing (i.e., neutral conditions)
- "Solubility model", "defined concentration cap" and "observed seepage" indicate constituents that are assumed to be at the referenced concentration caps (modeled or inferred from site or analog data) at all times (i.e., no release rate is defined)

**Large Table 6 Distribution Parameters for Category 1 Waste Rock Release**

**Distribution from Regression Analysis of Humidity Cell Data**

Constituent	Method	Source	Units	Distribution	Mean/Mode	St. Dev.	Minimum	Maximum
SO <sub>4</sub>	Rate Regression	HCT (1+2)	mg SO <sub>4</sub> /kg/week/%S	Normal	13.92	0.581	--	--

**Distribution Fit to Humidity Cell Data**

Constituent	Method	Source	Units	Distribution	Mean/Mode	St. Dev.	Minimum	Maximum
Ag	Rate	HCT (1+2)*	mg Ag/kg/week	Lognormal	6.46E-06	2.11E-02	--	--
Alkalinity	Rate	HCT (1+2)	mg Alk/kg/week	Beta	4.92E+00	2.21E+00	2.63E+00	1.15E+01
As	Rate	HCT (1+2)*	mg As/kg/week	Lognormal	1.85E-04	1.84E-04	--	--
B	Rate	HCT (1+2)*	mg B/kg/week	Lognormal	4.33E-03	1.27E-02	--	--
Be	Rate	HCT (1+2)*	mg Be/kg/week	Lognormal	6.37E-06	4.61E-05	--	--
Ca	Rate	HCT (1+2)	mg Ca/kg/week	Beta	1.15E+00	3.48E-01	5.78E-01	2.34E+00
Cd	Zn rate ratio	HCT (2)	mg Cd / mg Zn	Beta	2.03E-02	5.10E-03	1.44E-02	4.44E-02
Cl	First flush	HCT (all)	mg Cl / kg rock	Beta	9.78E+00	1.17E+01	1.38E+00	7.30E+01
Co	Ni rate ratio	HCT (2)	mg Co / mg Ni	Beta	1.55E-01	5.11E-02	7.28E-02	3.11E-01
Cr	Rate	HCT (1+2)*	mg Cr/kg/week	Lognormal	5.90E-05	2.80E-05	--	--
F	Rate	HCT (1+2)	mg F/kg/week	Beta	2.33E-02	1.08E-03	1.99E-02	2.52E-02
K	Rate	HCT (1+2)	mg K/kg/week	Beta	2.14E-01	9.17E-02	1.02E-01	4.98E-01
Mg	Rate	HCT (1+2)	mg Mg/kg/week	Beta	3.14E-01	2.04E-01	1.31E-01	1.10E+00
Mn	SO <sub>4</sub> rate ratio	HCT (2)	mg Mn / mg SO <sub>4</sub>	Beta	1.96E-03	9.73E-04	1.15E-03	5.95E-03
Na	Rate	HCT (1+2)	mg Na/kg/week	Beta	4.13E-01	4.02E-01	1.28E-01	2.50E+00
Pb	Rate	HCT (1+2)*	mg Pb/kg/week	Lognormal	6.56E-06	6.44E-06	--	--
Sb	Rate	Reactor*	mg Sb/kg/week	Lognormal	4.36E-04	4.81E-04	--	--
Se	SO <sub>4</sub> rate ratio	HCT (2)*	mg Se / mg SO <sub>4</sub>	Lognormal	1.90E-05	2.32E-04	--	--
Tl	Rate	HCT (1+2)*	mg Tl/kg/week	Lognormal	9.23E-07	1.77E-05	--	--
V	Rate	HCT (1+2)*	mg V/kg/week	Lognormal	1.52E-04	1.68E-04	--	--

**Distribution from Aqua Regia Data**

Constituent	Method	Source	Units	Distribution	Mean/Mode	St. Dev.	Minimum	Maximum
Ba	K ratio	Aqua Regia	mg Ba / mg K	Normal	2.90E-02	1.98E-04	--	--
Cu	S ratio	Aqua Regia	mg Cu / mg S	Normal	5.87E-01	2.51E-02	--	--
Zn	Mg ratio	Aqua Regia	mg Zn / mg Mg	Normal	1.81E-03	1.35E-05	--	--

**Distribution from Other Data**

Constituent	Method	Source	Units	Distribution	Mean/Mode	St. Dev.	Minimum	Maximum
Al	Ca ratio	Anorthite Formula	mg Al / mg Ca	Constant	1.35E+00	--	--	--
	Na ratio	Albite Formula	mg Al / mg Na	Constant	1.17E+00	--	--	--
Fe	S ratio	Pyrrhotite microprobe	mg Fe / mg S	Beta	1.62E+00	8.72E-02	1.49E+00	1.92E+00
	Mg ratio	Olivine microprobe	mg Fe / mg Mg	Beta	1.87E+00	6.75E-01	1.19E+00	4.51E+00
Ni	S ratio	Cat 4 Aqua Regia	mg Ni / mg S	Normal	3.06E-02	1.86E-03	--	--
	Mg ratio	Olivine microprobe	mg Ni / mg Mg	Beta	4.59E-03	1.95E-03	1.10E-04	7.43E-03

**Notes**

- Humidity cell data used through February 2011 unless noted otherwise.
- HCT (1+2) indicates average rates from humidity cells over Condition 1 and Condition 2, as defined in Large Table 1.
- HCT (2) indicates average rates from humidity cells over Condition 2, as defined in Large Table 1.
- \* indicates average rates from humidity cells over conditions noted with refined modeling of non-detects (see Section 8.1.2.1). Data used through December 2013.
- For Sb only the smaller MDNR-style reactors were used to estimate a release rate, including refined modeling of non-detects. Data used through February 2007.
- Except for SO<sub>4</sub>, all distributions from humidity cell data represent the full range of the observed values, with no weighting. Distributions are shown in Large Figures 1-4.
- Distributions from aqua regia data represent the uncertainty in the average ratios, weighted by geologic unit.
- Distributions from microprobe data represent the full range of the observed ratios for each mineral, with no weighting. Distributions are shown in Large Figures 21-22.
- For nickel, S ratio from Duluth Complex Category 4 aqua regia data represents the effect of all sulfide minerals combined. See example calculation in Section 8.1.2.3.
- For chloride, release is a one-time event per unit rock mass, developed from all Project humidity cells. See Section 8.4.4.

**Large Table 7 Distribution Parameters for Category 2/3 Waste Rock Release**

**Distribution from Regression Analysis of Humidity Cell Data**

Constituent	Method	Source	Units	Distribution	Mean/Mode	St. Dev.	Minimum	Maximum
SO <sub>4</sub>	Rate Regression	HCT (1+2)	mg SO <sub>4</sub> /kg/week/%S	Normal	13.92	0.581	--	--

**Distribution Fit to Humidity Cell Data**

Constituent	Method	Source	Units	Distribution	Mean/Mode	St. Dev.	Minimum	Maximum
Alkalinity	Nonacidic rate	HCT (1+2)	mg Alk/kg/week	Beta	4.50E+00	2.59E+00	1.45E+00	1.10E+01
	Acidic rate	None	mg Alk/kg/week	Constant	0	--	--	--
B	Nonacidic rate	HCT (1+2)*	mg B/kg/week	Lognormal	5.84E-03	1.10E-03	--	--
	Acidic rate	HCT (3)	mg B/kg/week	Triangular	4.58E-04	--	4.58E-04	1.61E-02
Ca	SO <sub>4</sub> rate ratio	HCT (1+2)	mg Ca / mg SO <sub>4</sub>	Beta	6.81E-01	4.29E-01	2.61E-01	2.59E+00
Cd	Zn rate ratio	HCT (2)	mg Cd / mg Zn	Beta	1.65E-02	1.20E-02	1.01E-03	5.84E-02
Cl	First flush	HCT (all)	mg Cl / kg rock	Beta	9.78E+00	1.17E+01	1.38E+00	7.30E+01
Co	Ni rate ratio	HCT (2)	mg Co / mg Ni	Beta	8.29E-02	3.91E-02	2.24E-02	2.06E-01
Cr	Nonacidic rate	HCT (1+2)*	mg Cr/kg/week	Lognormal	5.49E-05	2.19E-05	--	--
	Acidic rate	HCT (3)	mg Cr/kg/week	Triangular	9.17E-05	--	9.17E-05	1.06E-04
F	Nonacidic rate	HCT (1+2)	mg F/kg/week	Beta	2.36E-02	1.45E-03	2.04E-02	2.74E-02
	Acidic rate	HCT (3)	mg F/kg/week	Triangular	2.29E-02	--	2.27E-03	2.29E-02
K	SO <sub>4</sub> rate ratio	HCT (1+2)	mg K / mg SO <sub>4</sub>	Beta	1.29E-01	8.62E-02	5.39E-02	4.00E-01
Mg	SO <sub>4</sub> rate ratio	HCT (1+2)	mg Mg / mg SO <sub>4</sub>	Beta	1.39E-01	1.06E-01	3.37E-02	4.96E-01
Mn	SO <sub>4</sub> rate ratio	HCT (2)	mg Mn / mg SO <sub>4</sub>	Beta	2.81E-03	2.56E-03	4.36E-04	1.10E-02
Na	SO <sub>4</sub> rate ratio	HCT (1+2)	mg Na / mg SO <sub>4</sub>	Beta	1.33E-01	9.29E-02	3.54E-02	4.51E-01
Se	SO <sub>4</sub> rate ratio	HCT (2)	mg Se / mg SO <sub>4</sub>	Beta	3.54E-05	1.67E-05	1.30E-05	9.16E-05
Ti	Nonacidic rate	HCT (1+2)*	mg Ti/kg/week	Lognormal	2.73E-06	8.15E-06	--	--
	Acidic rate	HCT (3)	mg Ti/kg/week	Triangular	9.17E-06	--	9.17E-06	2.29E-05
Zn	Ni rate ratio	HCT (2)	mg Zn / mg Ni	Beta	3.35E-01	3.71E-01	3.31E-02	1.60E+00

**Distribution from Aqua Regia Data**

Constituent	Method	Source	Units	Distribution	Mean/Mode	St. Dev.	Minimum	Maximum
Ag	S ratio	Aqua Regia	mg Ag / mg S	Normal	1.32E-04	4.54E-06	--	--
As	S ratio	Aqua Regia	mg As / mg S	Normal	1.67E-03	1.28E-04	--	--
Ba	K ratio	Aqua Regia	mg Ba / mg K	Normal	2.93E-02	5.69E-04	--	--
Be	K ratio	Aqua Regia	mg Be / mg K	Normal	1.87E-04	3.77E-06	--	--
Cu	S ratio	Aqua Regia	mg Cu / mg S	Normal	3.59E-01	8.84E-03	--	--
Pb	S ratio	Aqua Regia	mg Pb / mg S	Normal	1.24E-03	5.95E-05	--	--
Sb	S ratio	Aqua Regia	mg Sb / mg S	Normal	6.53E-04	2.81E-05	--	--
V	K ratio	Aqua Regia	mg V / mg K	Normal	2.32E-02	7.29E-04	--	--

**Distribution from Other Data**

Constituent	Method	Source	Units	Distribution	Mean/Mode	St. Dev.	Minimum	Maximum
Al	Ca ratio	Anorthite Formula	mg Al / mg Ca	Constant	1.35E+00	--	--	--
	Na ratio	Albite Formula	mg Al / mg Na	Constant	1.17E+00	--	--	--
Fe	S ratio	Pyrrhotite microprobe	mg Fe / mg S	Beta	1.62E+00	8.72E-02	1.49E+00	1.92E+00
	Mg ratio	Olivine microprobe	mg Fe / mg Mg	Beta	1.87E+00	6.75E-01	1.19E+00	4.51E+00
Ni	S ratio	Cat 4 Aqua Regia	mg Ni / mg S	Normal	3.06E-02	1.86E-03	--	--
	Mg ratio	Olivine microprobe	mg Ni / mg Mg	Beta	4.59E-03	1.95E-03	1.10E-04	7.43E-03

**Notes**

- Humidity cell data used through February 2011 unless noted otherwise.
- HCT (1+2) indicates average rates from humidity cells over Condition 1 and Condition 2, as defined in Large Table 1.
- HCT (2) indicates average rates from humidity cells over Condition 2, as defined in Large Table 1.
- HCT (3) indicates average rates from humidity cells over Condition 3, as defined in Large Table 1.
- \* indicates average rates from humidity cells over conditions noted with refined modeling of non-detects (see Section 8.1.2.1). Data used through December 2013.
- Except for SO<sub>4</sub>, all distributions from humidity cell data represent the full range of the observed values, with no weighting. Distributions are shown in Large Figures 5-8.
- Acidic release rate for SO<sub>4</sub> to be determined from nonacidic rate times an acidic increase factor, as discussed in Section 8.2.5.
- Distributions from aqua regia data represent the uncertainty in the average ratios, weighted by geologic unit.
- Distributions from microprobe data represent the full range of the observed ratios for each mineral, with no weighting. Distributions are shown in Large Figures 21-22.
- For nickel, S ratio from Duluth Complex Category 4 aqua regia data represents the effect of all sulfide minerals combined. See example calculation in Section 8.1.2.3.
- For chloride, release is a one-time event per unit rock mass, developed from all Project humidity cells. See Section 8.4.4.



**Large Table 8 Distribution Parameters for Duluth Complex Category 4 Waste Rock Release**

**Distribution Fit to Humidity Cell Data**

<i>Constituent</i>	<i>Method</i>	<i>Source</i>	<i>Units</i>	<i>Distribution</i>	<i>Mean/Mode</i>	<i>St. Dev.</i>	<i>Minimum</i>	<i>Maximum</i>
Alkalinity	Nonacidic rate	HCT (1+2)	mg Alk/kg/week	Beta	4.43E+00	2.60E+00	1.47E+00	1.10E+01
	Acidic rate	None	mg Alk/kg/week	Constant	0	--	--	--
B	Nonacidic rate	HCT (1+2)*	mg B/kg/week	Lognormal	9.99E-03	6.37E-03	--	--
	Acidic rate	HCT (3)	mg B/kg/week	Beta	2.52E-03	2.49E-03	5.06E-04	1.00E-02
Ca	SO <sub>4</sub> rate ratio	HCT (1+2)	mg Ca / mg SO <sub>4</sub>	Beta	3.56E-01	1.26E-01	1.80E-01	7.91E-01
Cd	Zn rate ratio	HCT (2)	mg Cd / mg Zn	Beta	9.16E-03	5.39E-03	2.70E-03	3.15E-02
Cl	First flush	HCT (all)	mg Cl / kg rock	Beta	9.78E+00	1.17E+01	1.38E+00	7.30E+01
Co	Ni rate ratio	HCT (2)	mg Co / mg Ni	Beta	1.56E-01	7.51E-02	7.79E-02	4.64E-01
Cr	Nonacidic rate	HCT (1+2)*	mg Cr/kg/week	Lognormal	4.34E-05	7.03E-05	--	--
	Acidic rate	HCT (3)	mg Cr/kg/week	Beta	1.07E-04	1.20E-05	9.34E-05	1.47E-04
F	Nonacidic rate	HCT (1+2)	mg F/kg/week	Beta	4.68E-02	4.78E-02	2.16E-02	3.37E-01
	Acidic rate	HCT (3)	mg F/kg/week	Beta	2.57E-02	4.30E-03	2.25E-02	4.19E-02
K	SO <sub>4</sub> rate ratio	HCT (1+2)	mg K / mg SO <sub>4</sub>	Beta	1.00E-01	5.61E-02	2.61E-04	2.45E-01
Mg	SO <sub>4</sub> rate ratio	HCT (1+2)	mg Mg / mg SO <sub>4</sub>	Beta	6.61E-02	4.17E-02	2.92E-02	2.00E-01
Mn	SO <sub>4</sub> rate ratio	HCT (2)	mg Mn / mg SO <sub>4</sub>	Beta	2.94E-03	2.15E-03	5.94E-04	9.00E-03
Na	SO <sub>4</sub> rate ratio	HCT (1+2)	mg Na / mg SO <sub>4</sub>	Beta	1.06E-01	1.02E-01	1.43E-02	4.51E-01
Se	SO <sub>4</sub> rate ratio	HCT (2)	mg Se / mg SO <sub>4</sub>	Beta	1.87E-05	9.12E-06	9.15E-06	4.91E-05
SO <sub>4</sub>	Nonacidic rate	HCT (1+2)	mg SO <sub>4</sub> /kg/week	Beta	1.27E+01	8.37E+00	3.74E+00	5.50E+01
Ti	Nonacidic rate	HCT (1+2)*	mg Ti/kg/week	Lognormal	7.36E-06	6.40E-06	--	--
	Acidic rate	HCT (3)	mg Ti/kg/week	Beta	1.54E-05	7.94E-06	9.73E-06	4.26E-05
Zn	Ni rate ratio	HCT (2)	mg Zn / mg Ni	Beta	4.42E-01	6.79E-01	3.47E-02	3.50E+00

**Distribution from Aqua Regia Data**

<i>Constituent</i>	<i>Method</i>	<i>Source</i>	<i>Units</i>	<i>Distribution</i>	<i>Mean/Mode</i>	<i>St. Dev.</i>	<i>Minimum</i>	<i>Maximum</i>
Ag	S ratio	Aqua Regia	mg Ag / mg S	Normal	3.30E-05	3.21E-06	--	--
As	S ratio	Aqua Regia	mg As / mg S	Normal	1.40E-03	1.13E-04	--	--
Ba	K ratio	Aqua Regia	mg Ba / mg K	Normal	2.46E-02	1.17E-03	--	--
Be	K ratio	Aqua Regia	mg Be / mg K	Normal	3.30E-04	3.04E-05	--	--
Cu	S ratio	Aqua Regia	mg Cu / mg S	Normal	6.81E-02	4.76E-03	--	--
Pb	S ratio	Aqua Regia	mg Pb / mg S	Normal	3.97E-04	4.33E-05	--	--
Sb	S ratio	Aqua Regia	mg Sb / mg S	Normal	1.30E-04	9.01E-06	--	--
V	K ratio	Aqua Regia	mg V / mg K	Normal	4.33E-02	3.24E-03	--	--

**Distribution from Other Data**

<i>Constituent</i>	<i>Method</i>	<i>Source</i>	<i>Units</i>	<i>Distribution</i>	<i>Mean/Mode</i>	<i>St. Dev.</i>	<i>Minimum</i>	<i>Maximum</i>
Al	Ca ratio	Anorthite Formula	mg Al / mg Ca	Beta	1.35E+00	--	--	--
	Na ratio	Albite Formula	mg Al / mg Na	Beta	1.17E+00	--	--	--
Fe	S ratio	Pyrrhotite microprobe	mg Fe / mg S	Beta	1.62E+00	8.72E-02	1.49E+00	1.92E+00
	Mg ratio	Olivine microprobe	mg Fe / mg Mg	Beta	1.87E+00	6.75E-01	1.19E+00	4.51E+00
Ni	S ratio	Cat 4 Aqua Regia	mg Ni / mg S	Normal	3.06E-02	1.86E-03	--	--
	Mg ratio	Olivine microprobe	mg Ni / mg Mg	Beta	4.59E-03	1.95E-03	1.10E-04	7.43E-03

**Notes**

- Humidity cell data used through February 2011 unless noted otherwise.
- HCT (1+2) indicates average rates from humidity cells over Condition 1 and Condition 2, as defined in Large Table 1.
- HCT (2) indicates average rates from humidity cells over Condition 2, as defined in Large Table 1.
- HCT (3) indicates average rates from humidity cells over Condition 3, as defined in Large Table 1.
- \* indicates average rates from humidity cells over conditions noted with refined modeling of non-detects (see Section 8.1.2.1). Data used through December 2013.
- All distributions from humidity cell data represent the full range of the observed values, with no weighting. Distributions are shown in Large Figures 9-12.
- Acidic release rate for SO<sub>4</sub> to be determined from nonacidic rate times an acidic increase factor, as discussed in Section 8.2.5.
- Distributions from aqua regia data represent the uncertainty in the average ratios, weighted by geologic unit.
- Distributions from microprobe data represent the full range of the observed ratios for each mineral, with no weighting. Distributions are shown in Large Figures 21-22.
- For nickel, S ratio from Duluth Complex Category 4 aqua regia data represents the effect of all sulfide minerals combined. See example calculation in Section 8.1.2.3.
- For chloride, release is a one-time event per unit rock mass, developed from all Project humidity cells. See Section 8.4.4.

**Large Table 9 Distribution Parameters for Ore Release**

**Distribution from Regression Analysis of Humidity Cell Data**

Constituent	Method	Source	Units	Distribution	Mean/Mode	St. Dev.	Minimum	Maximum
SO <sub>4</sub>	Rate Regression	HCT (1+2)	mg SO <sub>4</sub> /kg/week/%S	Normal	13.92	0.581	--	--

**Distribution Fit to Humidity Cell Data**

Constituent	Method	Source	Units	Distribution	Mean/Mode	St. Dev.	Minimum	Maximum
Alkalinity	Nonacidic rate	HCT (1+2)	mg Alk/kg/week	Triangular	1.52E+00	--	1.37E+00	1.52E+00
	Acidic rate	None	mg Alk/kg/week	Constant	0	--	--	--
B	Nonacidic rate	HCT (1+2)	mg B/kg/week	Triangular	5.85E-03	--	5.09E-03	1.49E-02
Ca	SO <sub>4</sub> rate ratio	HCT (1+2)	mg Ca / mg SO <sub>4</sub>	Triangular	2.16E-01	--	2.16E-01	2.18E-01
Cd	Zn rate ratio	HCT (2)	mg Cd / mg Zn	Triangular	5.76E-03	--	5.76E-03	6.72E-03
Cl	First flush	HCT (all)	mg Cl / kg rock	Beta	9.78E+00	1.17E+01	1.38E+00	7.30E+01
Co	Ni rate ratio	HCT (2)	mg Co / mg Ni	Triangular	4.86E-02	--	4.86E-02	6.08E-02
Cr	Nonacidic rate	HCT (1+2)	mg Cr/kg/week	Triangular	1.10E-04	--	1.10E-04	1.18E-04
F	Nonacidic rate	HCT (1+2)	mg F/kg/week	Triangular	2.39E-02	--	2.39E-02	2.96E-02
K	SO <sub>4</sub> rate ratio	HCT (1+2)	mg K / mg SO <sub>4</sub>	Triangular	3.97E-02	--	3.22E-02	4.16E-02
Mg	SO <sub>4</sub> rate ratio	HCT (1+2)	mg Mg / mg SO <sub>4</sub>	Triangular	7.29E-02	--	7.29E-02	8.22E-02
Mn	SO <sub>4</sub> rate ratio	HCT (2)	mg Mn / mg SO <sub>4</sub>	Triangular	5.89E-03	--	5.45E-03	6.27E-03
Na	SO <sub>4</sub> rate ratio	HCT (1+2)	mg Na / mg SO <sub>4</sub>	Triangular	1.21E-02	--	1.21E-02	2.96E-01
Se	SO <sub>4</sub> rate ratio	HCT (2)	mg Se / mg SO <sub>4</sub>	Triangular	4.01E-05	--	4.01E-05	4.42E-05
Tl	Nonacidic rate	HCT (1+2)	mg Tl/kg/week	Triangular	2.22E-05	--	1.74E-05	2.22E-05
Zn	Ni rate ratio	HCT (2)	mg Zn / mg Ni	Triangular	2.28E-02	--	2.26E-02	3.00E-02

**Distribution from Aqua Regia Data**

Constituent	Method	Source	Units	Distribution	Mean/Mode	St. Dev.	Minimum	Maximum
Ag	S ratio	Aqua Regia	mg Ag / mg S	Normal	1.87E-04	2.80E-06	--	--
As	S ratio	Aqua Regia	mg As / mg S	Normal	9.20E-04	3.48E-05	--	--
Ba	K ratio	Aqua Regia	mg Ba / mg K	Normal	2.77E-02	1.06E-04	--	--
Be	K ratio	Aqua Regia	mg Be / mg K	Normal	1.22E-04	1.97E-06	--	--
Cu	S ratio	Aqua Regia	mg Cu / mg S	Normal	5.04E-01	5.62E-03	--	--
Pb	S ratio	Aqua Regia	mg Pb / mg S	Normal	1.05E-03	4.85E-05	--	--
Sb	S ratio	Aqua Regia	mg Sb / mg S	Normal	3.38E-04	1.17E-05	--	--
V	K ratio	Aqua Regia	mg V / mg K	Normal	2.19E-02	3.36E-04	--	--

**Distribution from Other Data**

Constituent	Method	Source	Units	Distribution	Mean/Mode	St. Dev.	Minimum	Maximum
Al	Ca ratio	Anorthite Formula	mg Al / mg Ca	Constant	1.35E+00	--	--	--
	Na ratio	Albite Formula	mg Al / mg Na	Constant	1.17E+00	--	--	--
Fe	S ratio	Pyrrhotite microprobe	mg Fe / mg S	Beta	1.62E+00	8.72E-02	1.49E+00	1.92E+00
	Mg ratio	Olivine microprobe	mg Fe / mg Mg	Beta	1.87E+00	6.75E-01	1.19E+00	4.51E+00
Ni	S ratio	Ore Aqua Regia	mg Ni / mg S	Normal	1.53E-01	3.26E-03	--	--
	Mg ratio	Olivine microprobe	mg Ni / mg Mg	Beta	4.59E-03	1.95E-03	1.10E-04	7.43E-03

**Notes**

- Humidity cell data used through February 2011 unless noted otherwise.
- HCT (1+2) indicates average rates from humidity cells over Condition 1 and Condition 2, as defined in Large Table 1.
- HCT (2) indicates average rates from humidity cells over Condition 2, as defined in Large Table 1.
- Except for SO<sub>4</sub>, all distributions from humidity cell data represent the full range of the observed values in the humidity cells, with no weighting. Distributions are shown in Large Figures 13-16. Distributions from humidity cells shown here are only used for the blended OSP; Category 2/3 humidity cells (see Large Table 8) are used to capture the full range of variability in the ore wall rock. Distributions are shown in Large Figures 13-16.
- Acidic release rate for SO<sub>4</sub> to be determined from nonacidic rate times an acidic increase factor, as discussed in Section 8.2.5.
- Distributions from aqua regia data represent the uncertainty in the average ratios, weighted by geologic unit.
- Distributions from microprobe data represent the full range of the observed ratios for each mineral, with no weighting. Distributions are shown in Large Figures 21-22.
- For nickel, S ratio from ore aqua regia data represents the effect of all sulfide minerals combined. See example calculation in Section 8.1.2.3.
- For B, Cr, F, and Tl no increase in release rates due to acidic conditions is indicated by laboratory data.
- For chloride, release is a one-time event per unit rock mass, developed from all Project humidity cells. See Section 8.4.4.

**Large Table 10 Distribution Parameters for Virginia Formation Category 4 Waste Rock Release**

**Distribution Fit to Humidity Cell Data**

<i>Constituent</i>	<i>Method</i>	<i>Source</i>	<i>Units</i>	<i>Distribution</i>	<i>Mean/Mode</i>	<i>St. Dev.</i>	<i>Minimum</i>	<i>Maximum</i>
Alkalinity	Acidic rate	None	mg Alk/kg/week	Constant	0	--	--	--
B	Acidic rate	HCT (3)	mg B/kg/week	Triangular	6.70E-03	--	6.70E-03	1.70E-02
Ca	SO <sub>4</sub> rate ratio	HCT (3)	mg Ca / mg SO <sub>4</sub>	Triangular	2.32E-02	--	2.32E-02	2.50E-01
Cl	First flush	HCT (all)	mg Cl / kg rock	Beta	9.78E+00	1.17E+01	1.38E+00	7.30E+01
Cr	Acidic rate	HCT (3)	mg Cr/kg/week	Triangular	1.11E-04	--	9.14E-05	1.28E-04
F	Acidic rate	HCT (3)	mg F/kg/week	Triangular	2.50E-02	--	2.50E-02	4.98E-02
Fe	SO <sub>4</sub> rate ratio	HCT (3)	mg Fe / mg SO <sub>4</sub>	Triangular	5.80E-02	--	3.98E-02	3.16E-01
K	SO <sub>4</sub> rate ratio	HCT (3)	mg K / mg SO <sub>4</sub>	Triangular	8.03E-03	--	8.03E-03	1.79E-02
Mg	SO <sub>4</sub> rate ratio	HCT (3)	mg Mg / mg SO <sub>4</sub>	Triangular	5.32E-02	--	2.93E-02	7.83E-02
Mn	Acidic rate	HCT (3)	mg Mn/kg/week	Triangular	7.11E-02	--	3.49E-02	1.56E-01
Na	SO <sub>4</sub> rate ratio	HCT (3)	mg Na / mg SO <sub>4</sub>	Triangular	5.64E-03	--	5.64E-03	1.79E-02
Se	SO <sub>4</sub> rate ratio	HCT (3)	mg Se / mg SO <sub>4</sub>	Triangular	8.52E-06	--	4.86E-06	9.20E-06
SO <sub>4</sub>	Acidic rate	HCT (3)	mg SO <sub>4</sub> /kg/week	Triangular	5.76E+01	--	4.44E+01	5.76E+01
Tl	Acidic rate	HCT (3)	mg Tl/kg/week	Triangular	1.11E-05	--	9.92E-06	1.21E-05

**Distribution from Aqua Regia Data**

<i>Constituent</i>	<i>Method</i>	<i>Source</i>	<i>Units</i>	<i>Distribution</i>	<i>Mean/Mode</i>	<i>St. Dev.</i>	<i>Minimum</i>	<i>Maximum</i>
Ag	S ratio	Aqua Regia	mg Ag / mg S	Normal	3.42E-05	2.23E-06	--	--
As	S ratio	Aqua Regia	mg As / mg S	Normal	2.87E-03	1.28E-04	--	--
Ba	K ratio	Aqua Regia	mg Ba / mg K	Normal	1.51E-02	5.79E-04	--	--
Be	S ratio	Aqua Regia	mg Be / mg S	Normal	1.02E-04	1.02E-05	--	--
Cd	S ratio	Aqua Regia	mg Cd / mg S	Normal	1.88E-04	5.11E-05	--	--
Co	S ratio	Aqua Regia	mg Co / mg S	Normal	4.26E-03	6.15E-04	--	--
Cu	S ratio	Aqua Regia	mg Cu / mg S	Normal	2.51E-02	2.59E-03	--	--
Ni	S ratio	Aqua Regia	mg Ni / mg S	Normal	1.76E-02	1.39E-03	--	--
Pb	S ratio	Aqua Regia	mg Pb / mg S	Normal	9.23E-04	3.07E-04	--	--
Sb	S ratio	Aqua Regia	mg Sb / mg S	Normal	2.70E-04	2.28E-05	--	--
V	K ratio	Aqua Regia	mg V / mg K	Normal	2.18E-02	1.07E-03	--	--
Zn	S ratio	Aqua Regia	mg Zn / mg S	Normal	3.03E-02	2.88E-03	--	--

**Distribution from Other Data**

<i>Constituent</i>	<i>Method</i>	<i>Source</i>	<i>Units</i>	<i>Distribution</i>	<i>Mean/Mode</i>	<i>St. Dev.</i>	<i>Minimum</i>	<i>Maximum</i>
Al	Ca ratio	Anorthite Formula	mg Al / mg Ca	Constant	1.35E+00	--	--	--
	Na ratio	Albite Formula	mg Al / mg Na	Constant	1.17E+00	--	--	--

Notes

- Humidity cell data used through February 2011 unless noted otherwise.
- HCT (3) indicates average rates from humidity cells over Condition 3, as defined in Large Table 1.
- All distributions from humidity cell data represent the full range of the observed values, with no weighting. Distributions are shown in Large Figures 17-20.
- Distributions from aqua regia data represent the uncertainty in the average ratios, weighted by geologic unit.
- For chloride, release is a one-time event per unit rock mass, developed from all Project humidity cells. See Section 8.4.4.

**Large Table 11 Proposed Approach for Deriving Concentration Caps**

Constituent	Duluth Complex Category 1		Non-Acidic Duluth Complex Category 2/3, 4 and Ore		Acidic Duluth Complex Category 2/3, 4 and Ore		Virginia Formation Category 4	
	Data Sources	Comments	Data Sources	Comments	Data Sources	Comments	Data Sources	Comments
<b>Primary Ions</b>								
SO <sub>4</sub>	Gypsum solubility		Gypsum solubility		Whistle Mine		Vangorda Mine	
Alkalinity	AMAX Pile pH 7 to 7.5	pH-dependent	AMAX Pile pH 6 to 7.5	pH-dependent	No alkalinity		No alkalinity	
Ca	Gypsum solubility		Gypsum solubility		Whistle Mine		Vangorda Mine	
Cl	None	No cap	None	No cap	None	No cap	None	No cap
Mg	Mg/Ca release ratio		Mg/Ca release ratio		Whistle Mine		Vangorda Mine	
Na	AMAX Pile pH 7 to 7.5	pH-dependent	AMAX Pile pH 6 to 7.5	pH-dependent	Whistle Mine		Vangorda Mine	
K	AMAX Pile pH 7 to 7.5	pH-dependent	AMAX Pile pH 6 to 7.5	pH-dependent	Whistle Mine		Vangorda Mine	
<b>Secondary Ions</b>								
Ag	Dunka Seep		Dunka Seep		Whistle Mine		Vangorda Mine	
Al	Gibbsite solubility	pH-dependent	Gibbsite solubility	pH-dependent	Whistle Mine		Whistle Mine	Higher than Vangorda Mine
As	Whistle Mine		Whistle Mine		Whistle Mine		Vangorda Mine	
B	Whistle Mine		Whistle Mine		Whistle Mine		Vangorda Mine	
Ba	Barite solubility		Barite solubility		Barite solubility		Vangorda Mine	
Be	Dunka Seep		Dunka Seep		Whistle Mine		Vangorda Mine	
Cd	Cd/Zn release ratio	Limited by Cd/Zn ratio	Cd/Zn release ratio	Limited by Cd/Zn ratio	Whistle Mine		Whistle Mine	Vangorda Cd mineralized
Co	AMAX Pile pH 7 to 7.5	pH-dependent	AMAX Pile pH 6 to 7.5	pH-dependent	Whistle Mine	Comparable to AMAX	Vangorda Mine	
Cr	Whistle Mine		Whistle Mine		Whistle Mine		Vangorda Mine	
Cu	AMAX Pile pH 7 to 7.5	pH-dependent	AMAX Pile pH 6 to 7.5	pH-dependent	AMAX Pile pH 3 to 4	Higher than Whistle Mine	Vangorda Mine	
F	Fluorite solubility		Fluorite solubility		Fluorite solubility		Fluorite solubility	
Fe	AMAX Pile pH 7 to 7.5	pH-dependent	AMAX Pile pH 6 to 7.5	pH-dependent	Whistle Mine		Vangorda Mine	
Mn	AMAX Pile pH 7 to 7.5	pH-dependent	AMAX Pile pH 6 to 7.5	pH-dependent	Whistle Mine	Comparable to AMAX	Vangorda Mine	
Ni	AMAX Pile pH 7 to 7.5	pH-dependent	AMAX Pile pH 6 to 7.5	pH-dependent	Whistle Mine	Comparable to AMAX	Vangorda Mine	
Pb	Whistle Mine		Whistle Mine		Whistle Mine		Whistle Mine	Vangorda Pb mineralized
Sb	NorthMet Lab Data		NorthMet Lab Data		Whistle Mine		Vangorda Mine	
Se	Se/SO <sub>4</sub> release ratio	Limited by Se/SO <sub>4</sub> ratio	Se/SO <sub>4</sub> release ratio	Limited by Se/SO <sub>4</sub> ratio	Whistle Mine		Vangorda Mine	
Tl	Dunka Seep		Dunka Seep		Vangorda Mine	No data for Whistle or AMAX	Vangorda Mine	
V	Whistle Mine		Whistle Mine		Whistle Mine		Vangorda Mine	
Zn	AMAX Pile pH 7 to 7.5	pH-dependent	AMAX Pile pH 6 to 7.5	pH-dependent	Whistle Mine	Comparable to AMAX	Whistle Mine	Vangorda Zn mineralized

**Notes**

- AMAX indicates the concentrations observed from the MDNR AMAX test piles at the referenced pH values.
- Whistle Mine indicates the concentrations observed from the Whistle Mine in Ontario, Canada for acidic & nonacidic waters as presented in Attachment A.
- Vangorda Mine indicates the concentrations observed from the Anvil Range Mine Complex in Yukon, Canada for acidic waters as presented in Attachment A.
- Dunka Seep indicates the highest observed concentration or detection limit from the available Dunka Mine data (a single sampling event in May 2006 at Seep X) multiplied by a factor of 10.
- NorthMet Lab Data indicates a range between the highest observed concentration in the NorthMet tailings humidity cells and an estimated field-scale value developed by MDNR.

**Large Table 12 Distribution Parameters for Category 1 Waste Rock Concentration Caps**

**Cap Value From Various Data Sources**

Constituent	Method	Source	Units	Distribution	Mean/Mode	Std. Deviation	Min.	Max.
Ag	Limit	Dunka Seep	mg/L	Constant	2.00E-04	--	--	--
As	Limit	Whistle Mine	mg/L	Constant	1.00E-01	--	--	--
B	Limit	Whistle Mine	mg/L	Constant	1.00E-01	--	--	--
Be	Limit	Dunka Seep	mg/L	Constant	4.00E-04	--	--	--
Cr	Limit	Whistle Mine	mg/L	Constant	1.00E-02	--	--	--
Pb	Limit	Whistle Mine	mg/L	Constant	1.00E-01	--	--	--
Sb	Limit	NorthMet Lab Data	mg/L	Uniform	--	--	8.30E-03	1.00E-01
Tl	Limit	Dunka Seep	mg/L	Constant	2.00E-04	--	--	--
V	Limit	Whistle Mine	mg/L	Constant	1.00E-02	--	--	--

**pH-based Range from AMAX Data**

(95th percentile values, all units mg/L)

pH	Alkalinity	Co	Cu	Fe	K	Mn	Na	Ni	Zn
8.1	5.00E+01	3.00E-02	3.00E-02	2.00E-02	4.00E+01	1.40E-01	2.40E+02	3.60E-01	2.00E-02
8.0	4.50E+01	1.00E-02	2.00E-02	2.00E-02	4.30E+01	1.40E-01	1.15E+02	2.00E-01	5.20E-02
7.9	4.00E+01	7.58E-02	5.73E-02	3.80E-02	4.80E+01	2.88E-01	3.90E+02	5.26E-01	8.88E-02
7.8	4.20E+01	6.00E-02	1.31E-01	5.50E-02	3.95E+01	2.05E-01	3.70E+02	3.75E-01	6.50E-02
7.7	4.50E+01	4.36E-02	1.23E-01	6.35E-02	4.37E+01	3.19E-01	4.68E+02	4.85E-01	1.15E-01
7.6	5.07E+01	4.00E-02	1.54E-01	7.75E-02	4.72E+01	2.10E-01	3.10E+02	4.55E-01	1.19E-01
7.5	4.82E+01	5.00E-02	1.00E-01	4.00E-02	4.60E+01	2.27E-01	2.18E+02	9.05E-01	9.64E-02
7.4	4.92E+01	7.00E-02	9.68E-02	4.20E-02	4.28E+01	1.72E-01	2.19E+02	1.28E+00	7.00E-02
7.3	3.59E+01	9.30E-02	2.00E-01	5.00E-02	5.04E+01	2.00E-01	2.31E+02	1.62E+00	1.33E-01
7.2	3.55E+01	1.36E-01	1.78E-01	1.01E-01	4.28E+01	1.75E-01	1.73E+02	2.08E+00	1.70E-01
7.1	3.45E+01	2.33E-01	2.85E-01	7.50E-02	4.61E+01	3.86E-01	1.38E+02	4.31E+00	2.93E-01
7.0	2.60E+01	2.80E-01	5.20E-01	4.00E-02	3.99E+01	3.08E-01	1.32E+02	5.91E+00	4.05E-01

**pH-based Range from AMAX Data**

(maximum values, all units mg/L)

pH	Alkalinity	Co	Cu	Fe	K	Mn	Na	Ni	Zn
8.1	7.00E+01	4.00E-02	4.00E-02	6.00E-02	4.60E+01	1.60E-01	3.17E+02	4.60E-01	2.50E-02
8.0	5.50E+01	1.00E-02	2.00E-02	2.00E-02	4.30E+01	1.40E-01	1.15E+02	2.00E-01	5.20E-02
7.9	4.00E+01	9.00E-02	6.00E-02	4.00E-02	4.90E+01	2.90E-01	3.95E+02	5.65E-01	9.00E-02
7.8	5.90E+01	7.00E-02	1.70E-01	6.00E-02	4.00E+01	2.40E-01	3.72E+02	4.20E-01	7.00E-02
7.7	5.10E+01	5.20E-02	1.31E-01	7.00E-02	5.00E+01	3.40E-01	5.55E+02	5.90E-01	1.20E-01
7.6	5.90E+01	6.00E-02	1.90E-01	2.10E-01	5.20E+01	2.30E-01	3.39E+02	1.07E+00	1.34E-01
7.5	5.27E+01	5.00E-02	1.30E-01	7.00E-02	6.00E+01	2.40E-01	3.13E+02	1.70E+00	1.00E-01
7.4	5.40E+01	8.00E-02	1.80E-01	6.00E-02	5.32E+01	1.90E-01	3.22E+02	1.35E+00	1.12E-01
7.3	3.60E+01	1.20E-01	2.60E-01	6.00E-02	5.90E+01	3.00E-01	2.60E+02	2.29E+00	2.30E-01
7.2	4.50E+01	1.50E-01	3.40E-01	7.00E-01	4.43E+01	2.40E-01	2.00E+02	3.42E+00	2.30E-01
7.1	4.10E+01	3.10E-01	7.50E-01	8.00E-02	4.80E+01	9.70E-01	5.91E+02	7.02E+00	3.70E-01
7.0	4.30E+01	6.20E-01	2.30E+00	4.00E-02	4.30E+01	3.80E-01	2.60E+02	1.30E+01	5.50E-01

**Notes**

- All distributions from AMAX data represent a uniform distribution between the 95th percentile and maximum observed value at the referenced pH for AMAX piles with 0.64% S. Data for pH values above 7.5 are used for Flotation Tailings as discussed in Section 10.4 (not for Category 1 waste rock).
- Whistle Mine indicates the concentrations observed from the Whistle Mine in Ontario, Canada for acidic & nonacidic waters as presented in Attachment A.
- Vangorda Mine indicates the concentrations observed from the Anvil Range Mine Complex in Yukon, Canada for acidic waters as presented in Attachment A.
- Dunka Seep indicates the highest observed concentration or detection limit from the available Dunka Mine data (a single sampling event in May 2006 at Seep X) multiplied by a factor of 10.
- NorthMet Lab Data indicates a range between the highest observed concentration in the NorthMet tailings humidity cells and an estimated field-scale value developed by MDNR.
- Concentration caps for all constituents not shown are calculated from the equations shown in Section 8.3.1.

**Large Table 13 Distribution Parameters for Duluth Complex Category 2/3, 4, and Ore Concentration Caps (nonacidic)**

**Cap Value From Various Data Sources**

Constituent	Method	Source	Units	Distribution	Mean/Mode	Std. Deviation	Min.	Max.
Ag	Limit	Dunka Seep	mg/L	Constant	2.00E-04	--	--	--
As	Limit	Whistle Mine	mg/L	Constant	1.00E-01	--	--	--
B	Limit	Whistle Mine	mg/L	Constant	1.00E-01	--	--	--
Be	Limit	Dunka Seep	mg/L	Constant	4.00E-04	--	--	--
Cr	Limit	Whistle Mine	mg/L	Constant	1.00E-02	--	--	--
Pb	Limit	Whistle Mine	mg/L	Constant	1.00E-01	--	--	--
Sb	Limit	NorthMet Lab Data	mg/L	Uniform	--	--	8.30E-03	1.00E-01
Tl	Limit	Dunka Seep	mg/L	Constant	2.00E-04	--	--	--
V	Limit	Whistle Mine	mg/L	Constant	1.00E-02	--	--	--

**pH-based Range from AMAX Data**

(95th percentile values, all units mg/L)

pH	Alkalinity	Co	Cu	Fe	K	Mn	Na	Ni	Zn
7.5	4.79E+01	2.48E-01	1.30E-01	7.45E-02	4.60E+01	1.40E+00	4.68E+02	1.50E+00	1.00E-01
7.4	4.90E+01	2.04E-01	1.47E-01	5.90E-02	4.21E+01	1.49E+00	3.94E+02	1.58E+00	9.73E-02
7.3	3.59E+01	9.30E-02	2.00E-01	5.00E-02	5.04E+01	2.00E-01	2.31E+02	1.62E+00	1.33E-01
7.2	3.53E+01	1.89E-01	2.33E-01	1.68E-01	4.25E+01	1.72E+00	3.47E+02	3.21E+00	1.82E-01
7.1	3.45E+01	2.31E-01	2.84E-01	8.00E-02	4.60E+01	6.46E-01	1.85E+02	4.31E+00	2.91E-01
7.0	2.60E+01	5.08E-01	5.59E-01	5.00E-02	3.96E+01	2.48E+00	2.41E+02	7.40E+00	4.09E-01
6.9	2.80E+01	1.02E+00	3.70E+00	1.78E-01	4.18E+01	1.90E+00	1.82E+02	1.98E+01	7.30E-01
6.8	2.16E+01	1.45E+00	5.02E+00	7.00E-02	5.06E+01	1.13E+00	1.50E+02	2.98E+01	1.24E+00
6.7	2.18E+01	1.24E+00	4.30E+00	1.02E-01	4.80E+01	3.61E+00	1.69E+02	2.06E+01	8.78E-01
6.6	1.44E+01	1.05E+00	5.44E+00	1.26E-01	5.07E+01	2.91E+00	2.05E+02	2.46E+01	8.66E-01
6.5	1.60E+01	1.52E+00	6.50E+00	6.00E-02	4.65E+01	1.39E+00	1.42E+02	3.15E+01	1.26E+00
6.4	1.53E+01	2.10E+00	7.09E+00	1.86E-01	4.88E+01	3.45E+00	1.78E+02	5.08E+01	1.51E+00
6.3	1.17E+01	2.11E+00	8.85E+00	8.40E-02	5.04E+01	3.03E+00	2.38E+02	4.75E+01	1.29E+00
6.2	6.90E+00	2.56E+00	1.02E+01	4.00E-02	5.37E+01	4.01E+00	4.39E+02	7.00E+01	1.87E+00
6.1	9.90E+00	3.13E+00	1.49E+01	5.85E-02	6.15E+01	3.26E+00	1.27E+02	8.35E+01	2.33E+00
6.0	9.40E+00	1.42E+00	8.56E+00	3.00E-02	4.97E+01	3.40E+00	1.64E+02	3.02E+01	1.60E+00

**pH-based Range from AMAX Data**

(maximum values, all units mg/L)

pH	Alkalinity	Co	Cu	Fe	K	Mn	Na	Ni	Zn
7.5	5.27E+01	2.80E-01	1.70E-01	1.50E-01	6.00E+01	1.68E+00	7.00E+02	1.70E+00	1.74E-01
7.4	5.40E+01	2.16E+00	1.80E-01	7.00E-02	5.32E+01	2.40E+00	4.91E+02	2.15E+01	3.96E-01
7.3	3.60E+01	1.20E-01	2.60E-01	6.00E-02	5.90E+01	3.00E-01	2.60E+02	2.29E+00	2.30E-01
7.2	4.50E+01	8.10E-01	3.40E-01	7.00E-01	4.43E+01	2.14E+00	8.62E+02	6.70E+00	2.30E-01
7.1	4.10E+01	3.10E-01	7.50E-01	1.20E-01	4.80E+01	1.64E+00	1.11E+03	7.02E+00	3.70E-01
7.0	4.30E+01	1.24E+00	2.30E+00	6.00E-02	4.30E+01	3.05E+00	2.69E+02	1.30E+01	5.50E-01
6.9	5.03E+01	1.71E+00	6.24E+00	3.00E-01	5.52E+01	2.28E+00	2.13E+02	4.50E+01	1.15E+00
6.8	3.30E+01	2.41E+00	7.25E+00	1.20E-01	5.80E+01	1.74E+00	3.13E+02	4.40E+01	1.65E+00
6.7	3.30E+01	1.41E+00	5.01E+00	1.30E-01	4.84E+01	5.57E+00	3.30E+02	4.10E+01	1.17E+00
6.6	3.90E+01	3.22E+00	1.10E+01	1.02E+00	8.40E+01	3.23E+00	2.40E+02	8.00E+01	2.25E+00
6.5	2.10E+01	1.87E+00	6.95E+00	6.00E-02	5.60E+01	1.89E+00	3.04E+02	4.30E+01	1.53E+00
6.4	2.20E+01	3.24E+00	7.57E+00	3.90E-01	5.10E+01	4.07E+00	2.70E+02	7.95E+01	1.69E+00
6.3	1.36E+01	2.30E+00	1.70E+01	1.00E-01	5.20E+01	3.32E+00	2.49E+02	6.70E+01	1.56E+00
6.2	6.90E+00	3.65E+00	1.20E+01	4.00E-02	5.40E+01	4.10E+00	6.09E+02	9.10E+01	2.01E+00
6.1	9.90E+00	3.34E+00	1.70E+01	6.00E-02	6.35E+01	3.36E+00	1.30E+02	9.10E+01	2.58E+00
6.0	1.11E+01	1.60E+00	1.10E+01	3.00E-02	5.20E+01	3.40E+00	2.01E+02	3.20E+01	1.61E+00

**Notes**

- All distributions from AMAX data represent a uniform distribution between the 95th percentile and maximum observed value at the referenced pH for all AMAX piles (0.64% S to 1.4% S).
- Whistle Mine indicates the concentrations observed from the Whistle Mine in Ontario, Canada for acidic & nonacidic waters as presented in Attachment A.
- Vangorda Mine indicates the concentrations observed from the Anvil Range Mine Complex in Yukon, Canada for acidic waters as presented in Attachment A.
- Dunka Seep indicates the highest observed concentration or detection limit from the available Dunka Mine data (a single sampling event in May 2006 at Seep X) multiplied by a factor of 10.
- NorthMet Lab Data indicates a range between the highest observed concentration in the NorthMet tailings humidity cells and an estimated field-scale value developed by MDNR.
- Concentration caps for all constituents not shown are calculated from the equations shown in Section 8.3.1.

**Large Table 14 Distribution Parameters for Duluth Complex Category 2/3, 4, and Ore Concentration Caps (acidic)**

**Distribution Fit to AMAX, Whistle, and Vangorda Mine Data**

<i>Constituent</i>	<i>Method</i>	<i>Source</i>	<i>Units</i>	<i>Distribution</i>	<i>Mean/Mode</i>	<i>St. Dev.</i>	<i>Minimum</i>	<i>Maximum</i>
Ag	Cap	Whistle Mine	mg/L	Beta	4.20E-02	4.62E-03	3.40E-02	5.00E-02
Al	Cap	Whistle Mine	mg/L	Beta	4.33E+02	2.68E+02	1.13E+02	1.00E+03
As	Cap	Whistle Mine	mg/L	Constant	1.00E-01	--	--	--
B	Cap	Whistle Mine	mg/L	Beta	2.19E-01	9.45E-02	9.23E-02	5.00E-01
Be	Cap	Whistle Mine	mg/L	Beta	1.62E-02	4.31E-03	5.26E-03	2.21E-02
Ca	Cap	Whistle Mine	mg/L	Beta	4.09E+02	4.15E+01	2.62E+02	5.54E+02
Cd	Cap	Whistle Mine	mg/L	Beta	1.47E-01	8.84E-02	5.35E-02	4.51E-01
Co	Cap	Whistle Mine	mg/L	Beta	3.04E+01	1.01E+01	8.68E+00	4.14E+01
Cr	Cap	Whistle Mine	mg/L	Beta	1.60E-02	5.77E-04	1.50E-02	1.70E-02
Cu	Cap	AMAX pH 3-4	mg/L	Beta	1.49E+02	1.30E+01	9.79E+01	1.79E+02
Fe	Cap	Whistle Mine	mg/L	Beta	9.57E+01	5.56E+01	1.61E+00	4.32E+02
K	Cap	Whistle Mine	mg/L	Beta	2.92E+01	9.52E+00	9.39E+00	1.53E+02
Mg	Cap	Whistle Mine	mg/L	Beta	9.92E+02	3.92E+02	4.82E+02	2.11E+03
Mn	Cap	Whistle Mine	mg/L	Beta	5.48E+01	2.32E+01	1.75E+01	1.03E+02
Na	Cap	Whistle Mine	mg/L	Beta	8.75E+01	6.32E+01	2.48E+01	7.17E+02
Ni	Cap	Whistle Mine	mg/L	Beta	6.41E+02	1.90E+02	9.97E+01	8.41E+02
Pb	Cap	Whistle Mine	mg/L	Beta	3.64E-01	1.36E-01	1.28E-01	6.00E-01
Sb	Cap	Whistle Mine	mg/L	Beta	2.00E+00	5.77E-01	1.00E+00	3.00E+00
Se	Cap	Whistle Mine	mg/L	Constant	1.00E-01	--	--	--
SO4	Cap	Whistle Mine	mg/L	Beta	9.52E+03	3.39E+03	3.29E+03	1.81E+04
TI	Cap	Vangorda Mine	mg/L	Beta	4.47E-02	1.22E-01	2.00E-03	2.18E+00
V	Cap	Whistle Mine	mg/L	Beta	5.50E-02	2.89E-03	5.00E-02	6.00E-02
Zn	Cap	Whistle Mine	mg/L	Beta	1.54E+01	1.27E+01	6.34E+00	6.00E+01

Notes

- All distributions from Whistle and Vangorda Mine data represent the full range of the observed values.
- All distributions from AMAX data represent the full range of the highest 5% of observed values in each 0.1 pH increment over the indicated pH range.
- Concentration caps for all constituents not shown are calculated from the equations shown in Section 8.3.1.
- Distributions shown as constant indicate zero detections in the referenced data set, the detection limit is set as the concentration cap.
- Beta distributions are shown in Large Figures 32-36.

**Large Table 15      Distribution Parameters for Virginia Formation Category 4 Waste Rock Concentration Caps**

**Distribution Fit to AMAX, Whistle, and Vangorda Mine Data**

<i>Constituent</i>	<i>Method</i>	<i>Source</i>	<i>Units</i>	<i>Distribution</i>	<i>Mean/Mode</i>	<i>St. Dev.</i>	<i>Minimum</i>	<i>Maximum</i>
Ag	Cap	Vangorda Mine	mg/L	Beta	5.86E-02	7.07E-02	6.24E-03	8.65E-01
Al	Cap	Whistle Mine	mg/L	Beta	4.33E+02	2.68E+02	1.13E+02	1.00E+03
As	Cap	Vangorda Mine	mg/L	Beta	4.21E-01	6.39E-01	1.13E-02	2.50E+00
B	Cap	Vangorda Mine	mg/L	Beta	1.39E+00	9.80E-01	1.30E-02	3.27E+00
Ba	Cap	Vangorda Mine	mg/L	Beta	2.61E-01	3.60E-01	4.96E-03	1.92E+00
Be	Cap	Vangorda Mine	mg/L	Beta	4.59E-02	6.82E-02	5.24E-03	3.20E-01
Ca	Cap	Vangorda Mine	mg/L	Beta	4.09E+02	4.85E+01	3.28E+02	4.98E+02
Cd	Cap	Whistle Mine	mg/L	Beta	1.47E-01	8.84E-02	5.35E-02	4.51E-01
Co	Cap	Vangorda Mine	mg/L	Beta	1.53E+01	6.86E+00	6.98E+00	3.08E+01
Cr	Cap	Vangorda Mine	mg/L	Beta	9.19E-02	1.52E-01	9.60E-03	8.70E-01
Cu	Cap	Vangorda Mine	mg/L	Beta	1.37E-01	1.03E-01	3.06E-02	6.08E-01
Fe	Cap	Vangorda Mine	mg/L	Beta	8.60E+02	1.23E+03	6.00E+00	5.08E+03
K	Cap	Vangorda Mine	mg/L	Beta	1.26E+01	8.42E+00	6.00E-01	3.00E+01
Mg	Cap	Vangorda Mine	mg/L	Beta	2.03E+03	1.48E+03	5.75E+02	6.20E+03
Mn	Cap	Vangorda Mine	mg/L	Beta	1.55E+03	1.13E+03	3.30E+02	4.32E+03
Na	Cap	Vangorda Mine	mg/L	Beta	1.67E+01	1.01E+01	7.39E+00	1.22E+02
Ni	Cap	Vangorda Mine	mg/L	Beta	1.08E+01	5.45E+00	4.17E+00	2.33E+01
Pb	Cap	Whistle Mine	mg/L	Beta	3.64E-01	1.36E-01	1.28E-01	6.00E-01
Sb	Cap	Vangorda Mine	mg/L	Beta	3.25E+00	2.78E+00	1.00E-03	1.60E+01
Se	Cap	Vangorda Mine	mg/L	Beta	4.34E-01	6.24E-01	7.33E-02	3.20E+00
SO4	Cap	Vangorda Mine	mg/L	Beta	2.23E+04	2.21E+04	3.54E+03	1.00E+05
Tl	Cap	Vangorda Mine	mg/L	Beta	4.47E-02	1.22E-01	2.00E-03	2.18E+00
V	Cap	Vangorda Mine	mg/L	Beta	6.00E-02	1.11E-01	3.00E-03	5.15E-01
Zn	Cap	Whistle Mine	mg/L	Beta	1.54E+01	1.27E+01	6.34E+00	6.00E+01

Notes

- All distributions from Whistle and Vangorda Mine data represent the full range of the observed values.
- Concentration caps for all constituents not shown are calculated from the equations shown in Section 8.3.1.
- Beta distributions are shown in Large Figures 37-41.



**Large Table 16 Distribution Parameters for Flotation Fine Tailings Release**

**Distribution Fit to Humidity Cell Data**

Constituent	Method	Source	Units	Distribution	Mean/Mode	St. Dev.	Minimum	Maximum
Ca	SO <sub>4</sub> rate ratio	HCT	mg Ca / mg SO <sub>4</sub>	Beta	1.18E+00	3.03E-01	8.17E-01	3.45E+00
K	SO <sub>4</sub> rate ratio	HCT	mg K / mg SO <sub>4</sub>	Beta	2.63E-01	6.37E-02	1.71E-01	7.51E-01
Mg	SO <sub>4</sub> rate ratio	HCT	mg Mg / mg SO <sub>4</sub>	Beta	2.18E-01	4.69E-02	1.62E-01	7.94E-01
Mn	Ni rate ratio	HCT	mg Mn / mg Ni	Beta	4.68E+00	2.25E+00	2.07E+00	9.31E+00
Na	SO <sub>4</sub> rate ratio	HCT	mg Na / mg SO <sub>4</sub>	Beta	8.20E-02	1.77E-02	6.03E-02	2.64E-01
Se	SO <sub>4</sub> rate ratio	HCT	mg Se / mg SO <sub>4</sub>	Beta	1.79E-05	5.29E-06	1.29E-05	6.09E-05
SO <sub>4</sub>	Rate	HCT*	mg SO <sub>4</sub> /kg/week	Beta	1.88E+01	2.87E+00	2.66E+00	2.32E+01

**Distribution Fit to Aqua Regia Data**

Constituent	Method	Source	Units	Distribution	Mean/Mode	St. Dev.	Minimum	Maximum
Ag	S ratio	Aqua Regia	mg Ag / mg S	Beta	1.54E-04	1.49E-05	1.35E-04	2.54E-04
As	S ratio	Aqua Regia	mg As / mg S	Beta	1.96E-03	2.53E-04	1.67E-03	4.89E-03
Ba	K ratio	Aqua Regia	mg Ba / mg K	Beta	2.66E-02	1.27E-03	1.83E-02	3.06E-02
Be	K ratio	Aqua Regia	mg Be / mg K	Beta	1.03E-04	1.51E-05	8.13E-05	2.32E-04
Cu	S ratio	Aqua Regia	mg Cu / mg S	Beta	9.30E-02	1.46E-02	5.29E-02	1.46E-01
Pb	S ratio	Aqua Regia	mg Pb / mg S	Beta	2.67E-03	6.16E-04	1.93E-03	9.32E-03
Sb	S ratio	Aqua Regia	mg Sb / mg S	Beta	1.08E-04	3.50E-05	6.67E-05	1.99E-04
Tl	S ratio	Aqua Regia	mg Tl / mg S	Beta	7.15E-05	7.35E-06	5.97E-05	1.41E-04
V	K ratio	Aqua Regia	mg V / mg K	Beta	2.53E-02	2.61E-03	7.01E-03	3.17E-02

**Distribution Fit to Waste Rock Humidity Cell Data**

Constituent	Method	Source	Units	Distribution	Mean/Mode	St. Dev.	Minimum	Maximum
Cd	Zn rate ratio	2/3 HCT (2)	mg Cd / mg Zn	Beta	1.65E-02	1.20E-02	1.01E-03	5.84E-02
Co	Ni rate ratio	2/3 HCT (2)	mg Co / mg Ni	Beta	8.29E-02	3.91E-02	2.24E-02	2.06E-01
Zn	Ni rate ratio	2/3 HCT (2)	mg Zn / mg Ni	Beta	3.35E-01	3.71E-01	3.31E-02	1.60E+00

**Distribution Fit to Microprobe Data or Mineral Formula**

Constituent	Method	Source	Units	Distribution	Mean/Mode	St. Dev.	Minimum	Maximum
Al	Ca ratio	Anorthite Formula	mg Al / mg Ca	Constant	1.35E+00	--	--	--
	Na ratio	Albite Formula	mg Al / mg Na	Constant	1.17E+00	--	--	--
Fe	S ratio	Pyrrhotite microprobe	mg Fe / mg S	Beta	1.62E+00	8.72E-02	1.49E+00	1.92E+00
	Mg ratio	Olivine microprobe	mg Fe / mg Mg	Beta	1.87E+00	6.75E-01	1.19E+00	4.51E+00
Ni	S ratio	Pyrrhotite microprobe	mg Ni / mg S	Beta	5.63E-03	6.65E-03	5.65E-04	4.00E-02

**Distribution From Defined Concentration Cap**

Constituent	Method	Source	Units	Distribution	Mean/Mode	St. Dev.	Minimum	Maximum
Cl	No release	N/A	mg/L	Constant	0	--	--	--
B	Cap	Whistle Mine	mg/L	Constant	1.00E-01	--	--	--
Cr	Cap	Whistle Mine	mg/L	Constant	1.00E-02	--	--	--

**Notes**

- HCT indicates average rates from tailings humidity cells over the entire testing period. Data used through April 2011.
- For sulfate, the release rate is the estimated release rate at the initial sulfur content for each humidity cell.
- Aqua Regia indicates ratios from whole tailings testing.
- Cat 2/3 HCT (2) indicates average rates from Category 2/3 humidity cells over Condition 2, as defined in Large Table 1.
- All distributions from humidity cell data and aqua regia data represent the full range of the observed values, with no weighting. Distributions are shown in Large Figure 42 to Large Figure 45.
- Distributions from microprobe data represent the full range of the observed ratios for each mineral, with no weighting. Distributions are shown in Large Figure 21 and Large Figure 22.
- Constituents not shown above are modeled according to the mineral solubility methods described in Section 10.1.1.

**Large Table 17 Distribution Parameters for Flotation Coarse Tailings Release**

**Distribution Fit to Humidity Cell Data**

<i>Constituent</i>	<i>Method</i>	<i>Source</i>	<i>Units</i>	<i>Distribution</i>	<i>Mean/Mode</i>	<i>St. Dev.</i>	<i>Minimum</i>	<i>Maximum</i>
Ca	SO <sub>4</sub> rate ratio	HCT	mg Ca / mg SO <sub>4</sub>	Beta	9.58E-01	3.34E-01	3.00E-01	1.60E+00
K	SO <sub>4</sub> rate ratio	HCT	mg K / mg SO <sub>4</sub>	Beta	2.60E-01	8.16E-02	0.00E+00	4.91E-01
Mg	SO <sub>4</sub> rate ratio	HCT	mg Mg / mg SO <sub>4</sub>	Beta	1.82E-01	3.32E-02	9.68E-02	5.46E-01
Mn	Ni rate ratio	HCT	mg Mn / mg Ni	Beta	3.37E+00	1.32E+00	1.80E+00	1.00E+01
Na	SO <sub>4</sub> rate ratio	HCT	mg Na / mg SO <sub>4</sub>	Beta	6.86E-02	2.40E-02	3.58E-02	2.57E-01
Se	SO <sub>4</sub> rate ratio	HCT	mg Se / mg SO <sub>4</sub>	Beta	1.75E-05	3.51E-06	0.00E+00	2.41E-05
SO <sub>4</sub>	Rate	HCT	mg SO <sub>4</sub> /kg/week	Beta	1.19E+01	2.55E+00	4.37E+00	2.13E+01

**Distribution Fit to Aqua Regia Data**

<i>Constituent</i>	<i>Method</i>	<i>Source</i>	<i>Units</i>	<i>Distribution</i>	<i>Mean/Mode</i>	<i>St. Dev.</i>	<i>Minimum</i>	<i>Maximum</i>
Ag	S ratio	Aqua Regia	mg Ag / mg S	Beta	2.05E-04	3.41E-05	1.42E-04	5.45E-04
As	S ratio	Aqua Regia	mg As / mg S	Beta	1.82E-03	3.31E-04	9.17E-04	5.09E-03
Ba	K ratio	Aqua Regia	mg Ba / mg K	Beta	2.74E-02	1.81E-03	2.01E-02	4.02E-02
Be	K ratio	Aqua Regia	mg Be / mg K	Beta	9.77E-05	9.41E-06	5.71E-05	1.53E-04
Cu	S ratio	Aqua Regia	mg Cu / mg S	Beta	2.11E-01	5.25E-02	2.95E-03	7.00E-01
Pb	S ratio	Aqua Regia	mg Pb / mg S	Beta	2.88E-03	7.68E-04	1.18E-03	1.08E-02
Sb	S ratio	Aqua Regia	mg Sb / mg S	Beta	1.10E-04	3.06E-05	5.45E-05	2.50E-04
Tl	S ratio	Aqua Regia	mg Tl / mg S	Beta	9.44E-05	1.27E-05	6.67E-05	1.86E-04
V	K ratio	Aqua Regia	mg V / mg K	Beta	1.81E-02	2.66E-03	1.81E-03	3.00E-02

**Distribution Fit to Waste Rock Humidity Cell Data**

<i>Constituent</i>	<i>Method</i>	<i>Source</i>	<i>Units</i>	<i>Distribution</i>	<i>Mean/Mode</i>	<i>St. Dev.</i>	<i>Minimum</i>	<i>Maximum</i>
Cd	Zn rate ratio	2/3 HCT (2)	mg Cd / mg Zn	Beta	1.65E-02	1.20E-02	1.01E-03	5.84E-02
Co	Ni rate ratio	2/3 HCT (2)	mg Co / mg Ni	Beta	8.29E-02	3.91E-02	2.24E-02	2.06E-01
Zn	Ni rate ratio	2/3 HCT (2)	mg Zn / mg Ni	Beta	3.35E-01	3.71E-01	3.31E-02	1.60E+00

**Distribution Fit to Microprobe Data or Mineral Formula**

<i>Constituent</i>	<i>Method</i>	<i>Source</i>	<i>Units</i>	<i>Distribution</i>	<i>Mean/Mode</i>	<i>St. Dev.</i>	<i>Minimum</i>	<i>Maximum</i>
Al	Ca ratio	Anorthite Formula	mg Al / mg Ca	Constant	1.35E+00	--	--	--
	Na ratio	Albite Formula	mg Al / mg Na	Constant	1.17E+00	--	--	--
Fe	S ratio	Pyrrhotite microprobe	mg Fe / mg S	Beta	1.62E+00	8.72E-02	1.49E+00	1.92E+00
	Mg ratio	Olivine microprobe	mg Fe / mg Mg	Beta	1.87E+00	6.75E-01	1.19E+00	4.51E+00
Ni	S ratio	Pyrrhotite microprobe	mg Ni / mg S	Beta	5.63E-03	6.65E-03	5.65E-04	4.00E-02

**Distribution From Defined Concentration Cap**

<i>Constituent</i>	<i>Method</i>	<i>Source</i>	<i>Units</i>	<i>Distribution</i>	<i>Mean/Mode</i>	<i>St. Dev.</i>	<i>Minimum</i>	<i>Maximum</i>
Cl	No release	N/A	mg/L	Constant	0	--	--	--
B	Cap	Whistle Mine	mg/L	Constant	1.00E-01	--	--	--
Cr	Cap	Whistle Mine	mg/L	Constant	1.00E-02	--	--	--

**Notes**

- HCT indicates average rates from tailings humidity cells over the entire testing period. Data used through April 2011.
- For sulfate, the release rate is the estimated release rate at the initial sulfur content for each humidity cell.
- Aqua Regia indicates ratios from whole tailings testing.
- Cat 2/3 HCT (2) indicates average rates from Category 2/3 humidity cells over Condition 2, as defined in Large Table 1.
- All distributions from humidity cell data and aqua regia data represent the full range of the observed values, with no weighting. Distributions are shown in Large Figure 46 to Large Figure 49.
- Distributions from microprobe data represent the full range of the observed ratios for each mineral, with no weighting. Distributions are shown in Large Figure 21 and Large Figure 22.
- Constituents not shown above are modeled according to the mineral solubility methods described in Section 10.1.1.

**Large Table 18 Distribution Parameters for LTVSMC Tailings Release**

**Distribution Fit to Humidity Cell Data**

<i>Constituent</i>	<i>Method</i>	<i>Source</i>	<i>Units</i>	<i>Distribution</i>	<i>Mean/Mode</i>	<i>St. Dev.</i>	<i>Minimum</i>	<i>Maximum</i>
Se	SO <sub>4</sub> rate ratio	HCT	mg Se / mg SO <sub>4</sub>	Beta	7.22E-05	4.63E-05	3.04E-05	3.04E-04
SO <sub>4</sub>	Rate	HCT	mg SO <sub>4</sub> /kg/week	Beta	1.87E+00	5.02E-01	8.13E-01	2.54E+00
Zn	SO <sub>4</sub> rate ratio	HCT	mg Zn / mg SO <sub>4</sub>	Beta	5.32E-05	9.20E-06	4.28E-05	8.33E-05

**Distribution Fit to Aqua Regia Data**

<i>Constituent</i>	<i>Method</i>	<i>Source</i>	<i>Units</i>	<i>Distribution</i>	<i>Mean/Mode</i>	<i>St. Dev.</i>	<i>Minimum</i>	<i>Maximum</i>
Ag	S ratio	Aqua Regia	mg Ag / mg S	Beta	1.85E-04	1.51E-04	3.47E-05	1.99E-03
As	S ratio	Aqua Regia	mg As / mg S	Beta	1.11E-01	5.43E-02	2.85E-02	8.75E-01
Cd	S ratio	Aqua Regia	mg Cd / mg S	Beta	7.69E-05	6.83E-05	8.21E-06	4.62E-03
Co	S ratio	Aqua Regia	mg Co / mg S	Beta	4.10E-02	3.17E-02	9.94E-03	3.75E-01
Cu	S ratio	Aqua Regia	mg Cu / mg S	Beta	4.26E-02	3.66E-02	7.95E-03	7.00E-01
Ni	S ratio	Aqua Regia	mg Ni / mg S	Beta	1.71E-02	1.10E-02	3.46E-03	1.92E-01
Pb	S ratio	Aqua Regia	mg Pb / mg S	Beta	6.66E-03	3.95E-03	1.12E-03	4.17E-02
Sb	S ratio	Aqua Regia	mg Sb / mg S	Beta	3.44E-04	2.34E-04	8.93E-05	2.92E-03
Tl	S ratio	Aqua Regia	mg Tl / mg S	Beta	9.04E-05	7.48E-05	1.95E-05	8.33E-04

**Distribution Fit to Microprobe Data**

<i>Constituent</i>	<i>Method</i>	<i>Source</i>	<i>Units</i>	<i>Distribution</i>	<i>Mean/Mode</i>	<i>St. Dev.</i>	<i>Minimum</i>	<i>Maximum</i>
Fe	S ratio	Pyrite microprobe	mg Fe / mg S	Beta	8.85E-01	1.36E-02	8.50E-01	9.06E-01

**Distribution Fit to Observed Seepage Data**

<i>Constituent</i>	<i>Method</i>	<i>Source</i>	<i>Units</i>	<i>Distribution</i>	<i>Mean/Mode</i>	<i>St. Dev.</i>	<i>Minimum</i>	<i>Maximum</i>
Al	Cap	Well Data	mg/L	Uniform	--	--	5.00E-03	2.50E-02
B	Cap	Well Data	mg/L	Beta	3.39E-01	1.03E-01	2.50E-02	5.65E-01
Be	Cap	Well Data	mg/L	Uniform	--	--	1.00E-04	2.50E-04
Ca	Cap	Well Data	mg/L	Beta	7.86E+01	3.79E+01	1.39E+01	1.77E+02
Cl	Cap	Well Data	mg/L	Beta	2.04E+01	7.74E+00	9.25E-01	2.97E+01
Cr	Cap	Well Data	mg/L	Beta	3.65E-03	4.90E-03	4.46E-04	2.81E-02
K	Cap	Well Data	mg/L	Beta	5.58E+00	3.87E+00	1.54E+00	2.02E+01
Mg	Ca ratio	Well Data	mg Mg / mg Ca	Beta	1.07E+00	4.57E-01	5.80E-01	2.10E+00
Mn	Cap	Well Data	mg/L	Beta	9.34E-01	9.92E-01	4.46E-02	6.54E+00
Na	Cap	Well Data	mg/L	Beta	6.01E+01	2.15E+01	4.18E+01	1.51E+02
V	Cap	Well Data	mg/L	Uniform	--	--	5.00E-04	1.00E-03

**Notes**

- HCT indicates average rates from tailings humidity cells over the entire testing period. Data used through April 2011.
- Aqua Regia indicates ratios from whole tailings testing.
- Cat 2/3 HCT (2) indicates average rates from Category 2/3 humidity cells over Condition 2, as defined in Large Table 1.
- All distributions from humidity cell data, aqua regia and microprobe data represent the full range of the observed values, with no weighting. Distributions are shown in Large Figure 50 to Large Figure 52.
- All distributions from well data represent the full range of observed values for wells GW-001, GW-006, GW-007, GW-008, and GW-012. Distributions are shown in Large Figure 53 to Large Figure 55.
- Constituents not shown above are modeled according to the mineral solubility methods described in Section 10.1.2.

**Large Table 19 Distribution Parameters for LTVSMC Tailings Disturbed Flushing Load**

**Distribution Fit to Leach Extraction Test Data**

<i>Constituent</i>	<i>Method</i>	<i>Source</i>	<i>Units</i>	<i>Distribution</i>	<i>Mean/Mode</i>	<i>St. Dev.</i>	<i>Minimum</i>	<i>Maximum</i>
Ag	Load	Leach tests	mg/kg tailings	Beta	2.09E-05	4.85E-06	1.16E-05	3.73E-05
Al	Load	Leach tests	mg/kg tailings	Beta	2.16E-03	1.25E-03	1.26E-04	7.43E-03
Alkalinity	Load	Leach tests	mg/kg tailings	Beta	9.88E+01	2.62E+01	0.00E+00	1.27E+02
As	Load	Leach tests	mg/kg tailings	Beta	2.10E-03	2.96E-03	1.56E-04	2.15E-02
B	Load	Leach tests	mg/kg tailings	Beta	5.51E-02	1.98E-02	3.04E-02	1.90E-01
Ba	Load	Leach tests	mg/kg tailings	Beta	1.86E-03	2.96E-03	5.00E-05	2.00E-02
Be	Load	Leach tests	mg/kg tailings	Beta	7.50E-05	1.44E-05	5.00E-05	1.00E-04
Ca	Load	Leach tests	mg/kg tailings	Beta	1.79E+01	6.21E+00	9.30E+00	4.21E+01
Cd	Load	Leach tests	mg/kg tailings	Beta	1.50E-05	2.89E-06	1.00E-05	2.00E-05
Co	Load	Leach tests	mg/kg tailings	Beta	1.38E-04	1.00E-04	3.95E-05	4.97E-04
Cr	Load	Leach tests	mg/kg tailings	Beta	6.08E-04	6.87E-04	6.56E-05	4.00E-03
Cu	Load	Leach tests	mg/kg tailings	Beta	1.77E-03	1.13E-03	6.61E-04	8.00E-03
F	Load	Leach tests	mg/kg tailings	Beta	2.52E-01	2.08E-01	5.40E-02	1.53E+00
Fe	Load	Leach tests	mg/kg tailings	Beta	1.66E-02	1.20E-02	2.12E-03	4.88E-02
K	Load	Leach tests	mg/kg tailings	Beta	2.02E+00	2.20E+00	4.17E-01	1.00E+01
Mg	Load	Leach tests	mg/kg tailings	Beta	1.64E+01	8.20E+00	1.56E+00	6.28E+01
Mn	Load	Leach tests	mg/kg tailings	Beta	2.43E-02	3.33E-02	4.72E-04	2.51E-01
Na	Load	Leach tests	mg/kg tailings	Beta	3.67E+00	6.70E+00	2.33E-01	4.03E+01
Ni	Load	Leach tests	mg/kg tailings	Beta	5.98E-04	3.61E-04	1.91E-04	1.70E-03
Pb	Load	Leach tests	mg/kg tailings	Beta	3.75E-05	2.82E-05	1.67E-05	2.00E-04
Sb	Load	Leach tests	mg/kg tailings	Beta	7.50E-05	5.52E-05	3.33E-05	3.19E-04
Se	Load	Leach tests	mg/kg tailings	Beta	6.61E-04	6.73E-04	9.70E-05	4.93E-03
SO <sub>4</sub>	Load	Leach tests	mg/kg tailings	Beta	2.14E+01	3.09E+01	1.27E+00	1.92E+02
Tl	Load	Leach tests	mg/kg tailings	Beta	7.50E-06	1.44E-06	5.00E-06	1.00E-05
V	Load	Leach tests	mg/kg tailings	Beta	8.01E-05	1.51E-05	3.74E-05	1.02E-04
Zn	Load	Leach tests	mg/kg tailings	Beta	1.08E-03	8.49E-04	4.00E-04	4.00E-03

Notes

- All distributions from leach extraction testing represent the full range of observed data.
- Distributions for constituents with no detections range from LOD/2 to LOD with a uniform distribution.
- Distributions are shown in Large Figure 56 to Large Figure 60.

## Large Figures

Large Figure 1

Distributions from Humidity Cells for Category 1 Waste Rock (a)

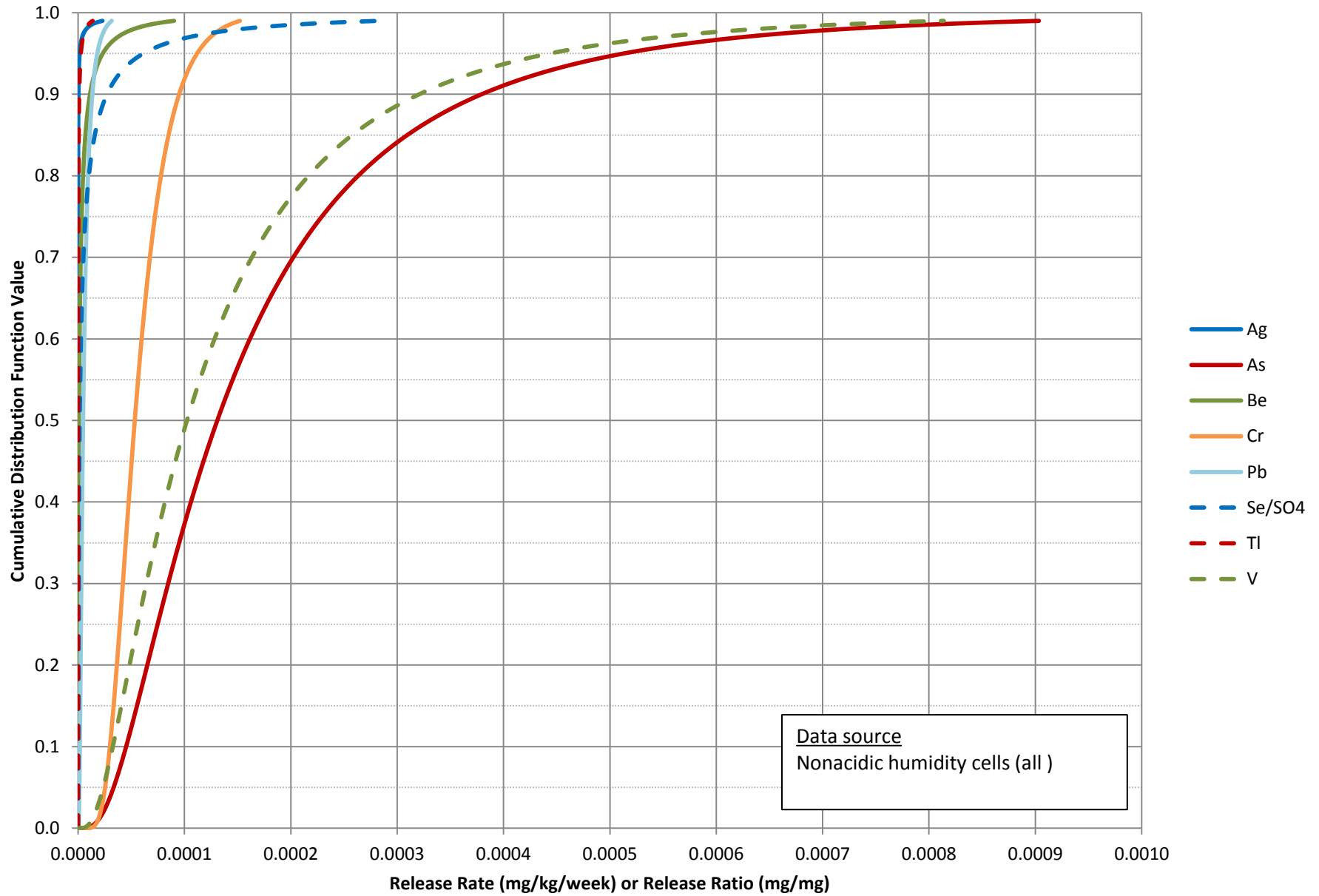

Large Figure 2

Distributions from Humidity Cells for Category 1 Waste Rock (b)

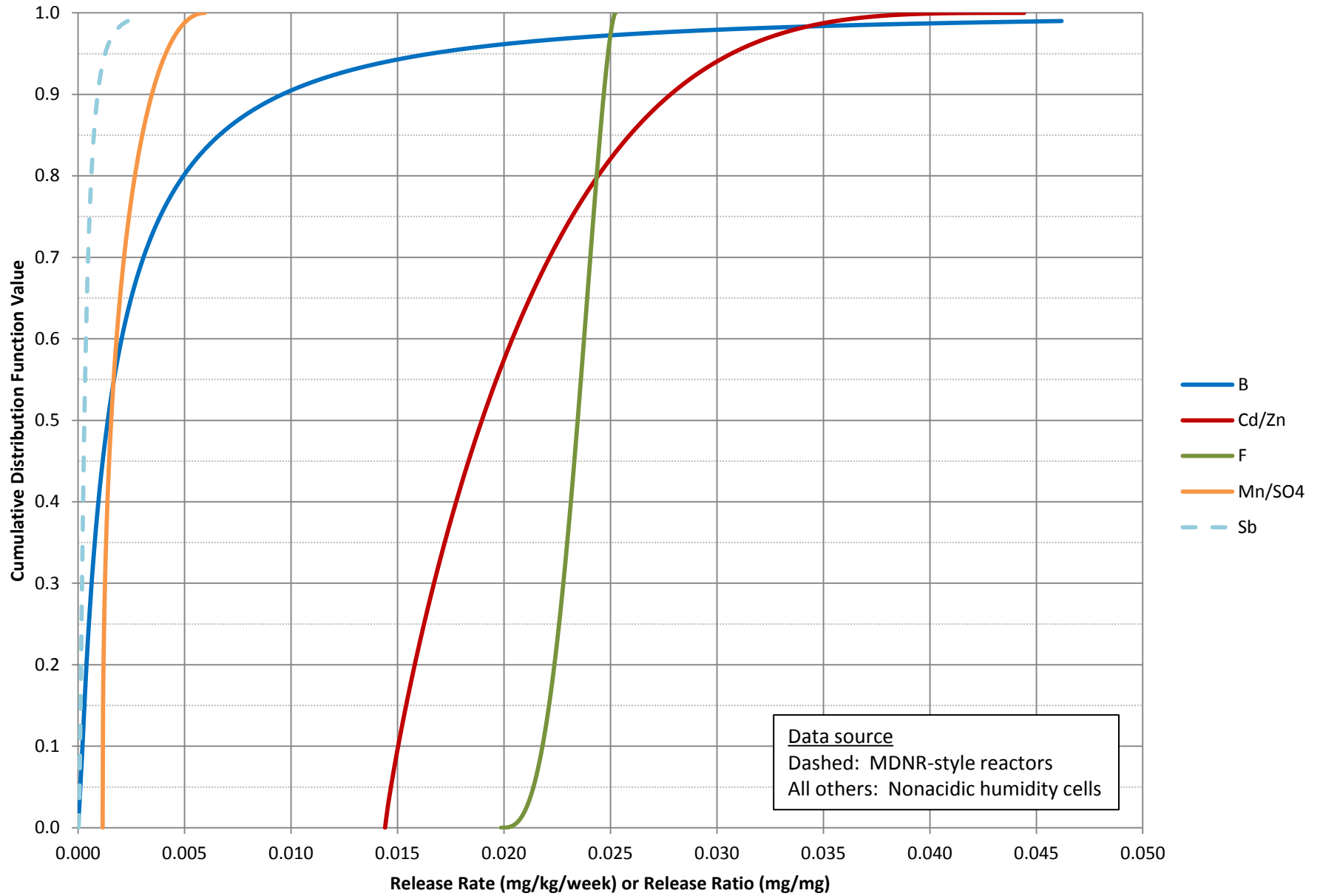

Large Figure 3

Distributions from Humidity Cells for Category 1 Waste Rock (c)

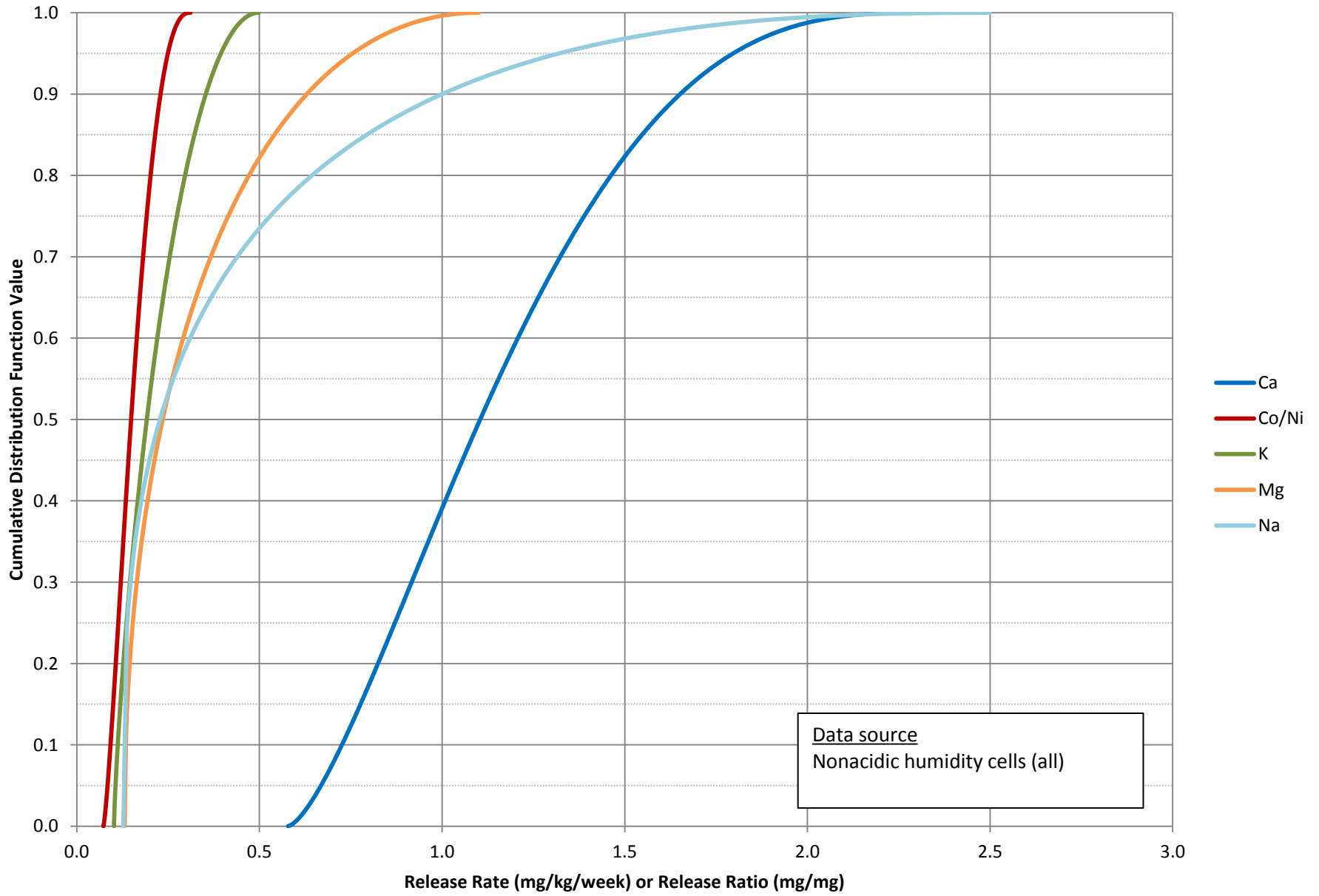



Large Figure 4

Distributions from Humidity Cells for Category 1 Waste Rock (d)

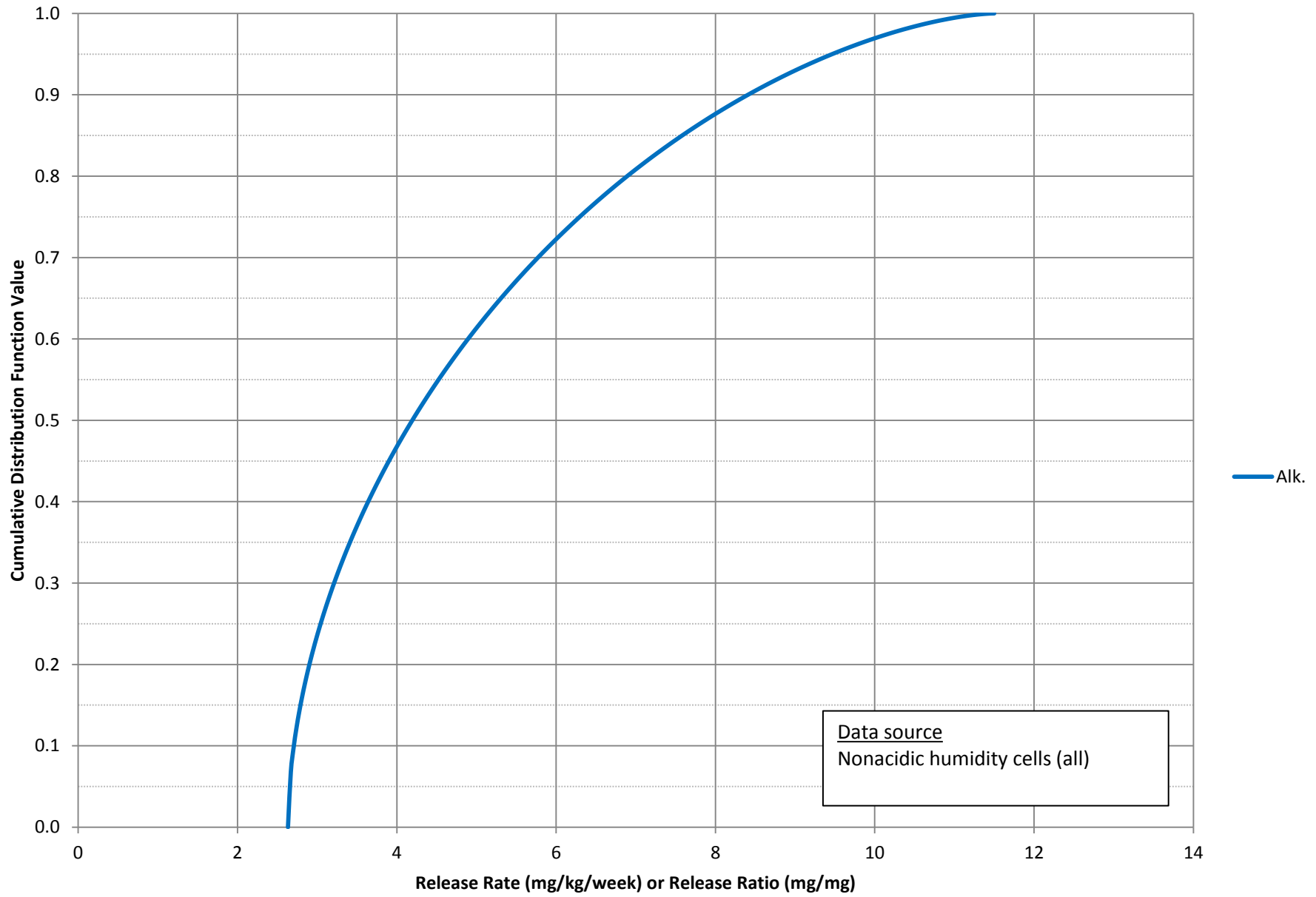

Large Figure 5

Distributions from Humidity Cells for Category 2/3 Waste Rock and Ore Wall Rock (a)

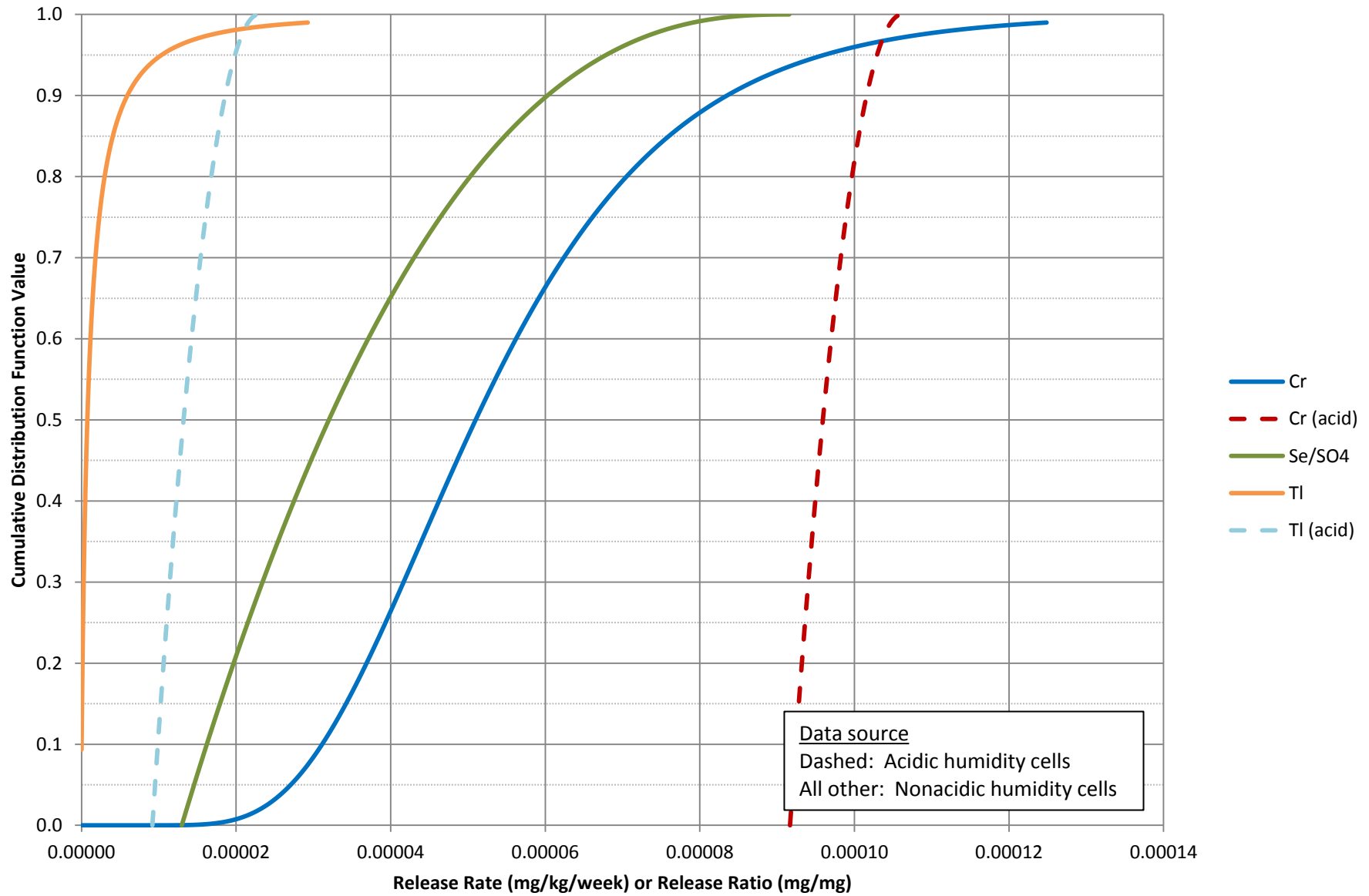

Large Figure 6

Distributions from Humidity Cells for Category 2/3 Waste Rock and Ore Wall Rock (b)

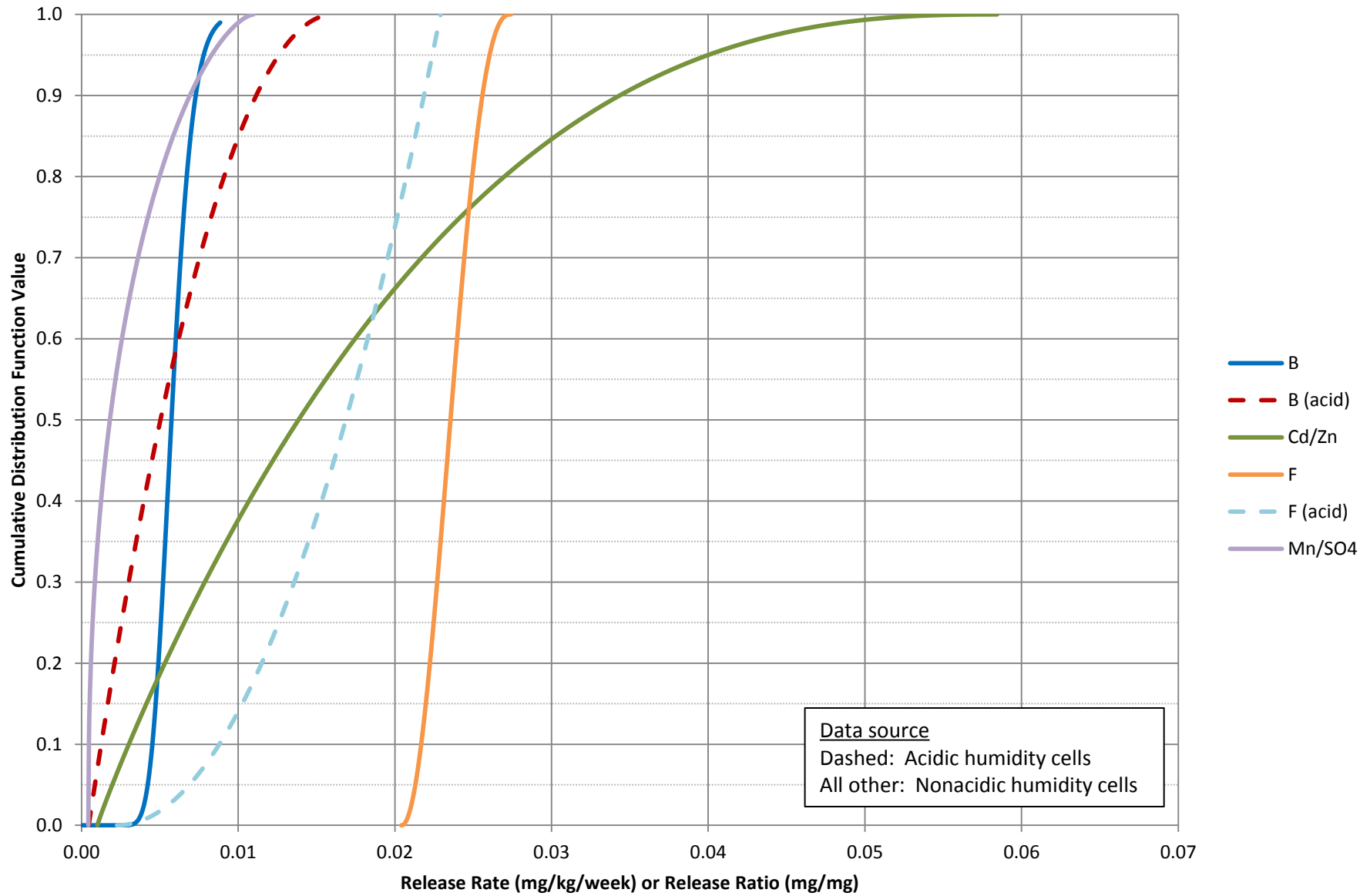

Large Figure 7

Distributions from Humidity Cells for Category 2/3 Waste Rock and Ore Wall Rock (c)

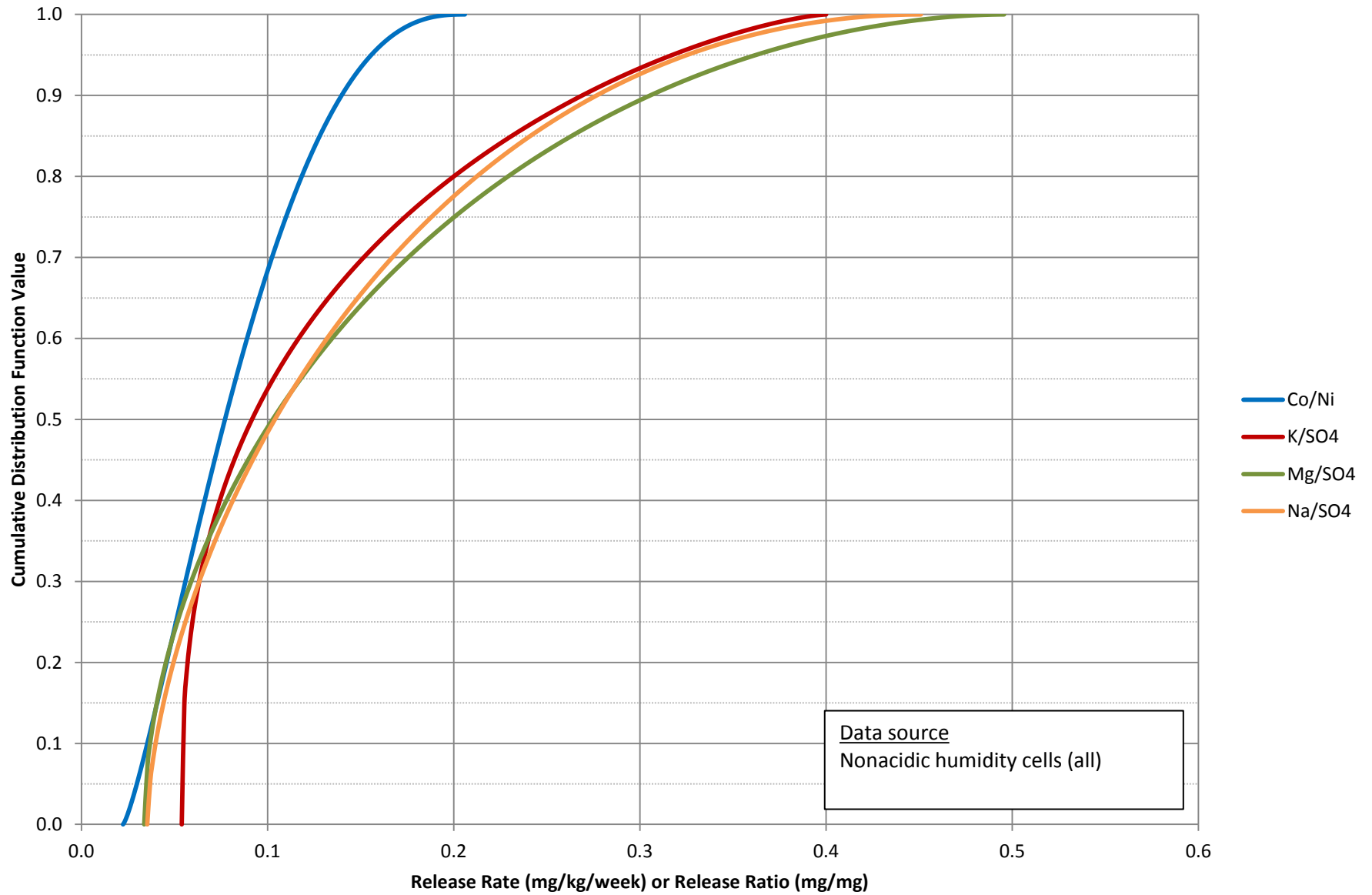

Large Figure 8

Distributions from Humidity Cells for Category 2/3 Waste Rock and Ore Wall Rock (d)

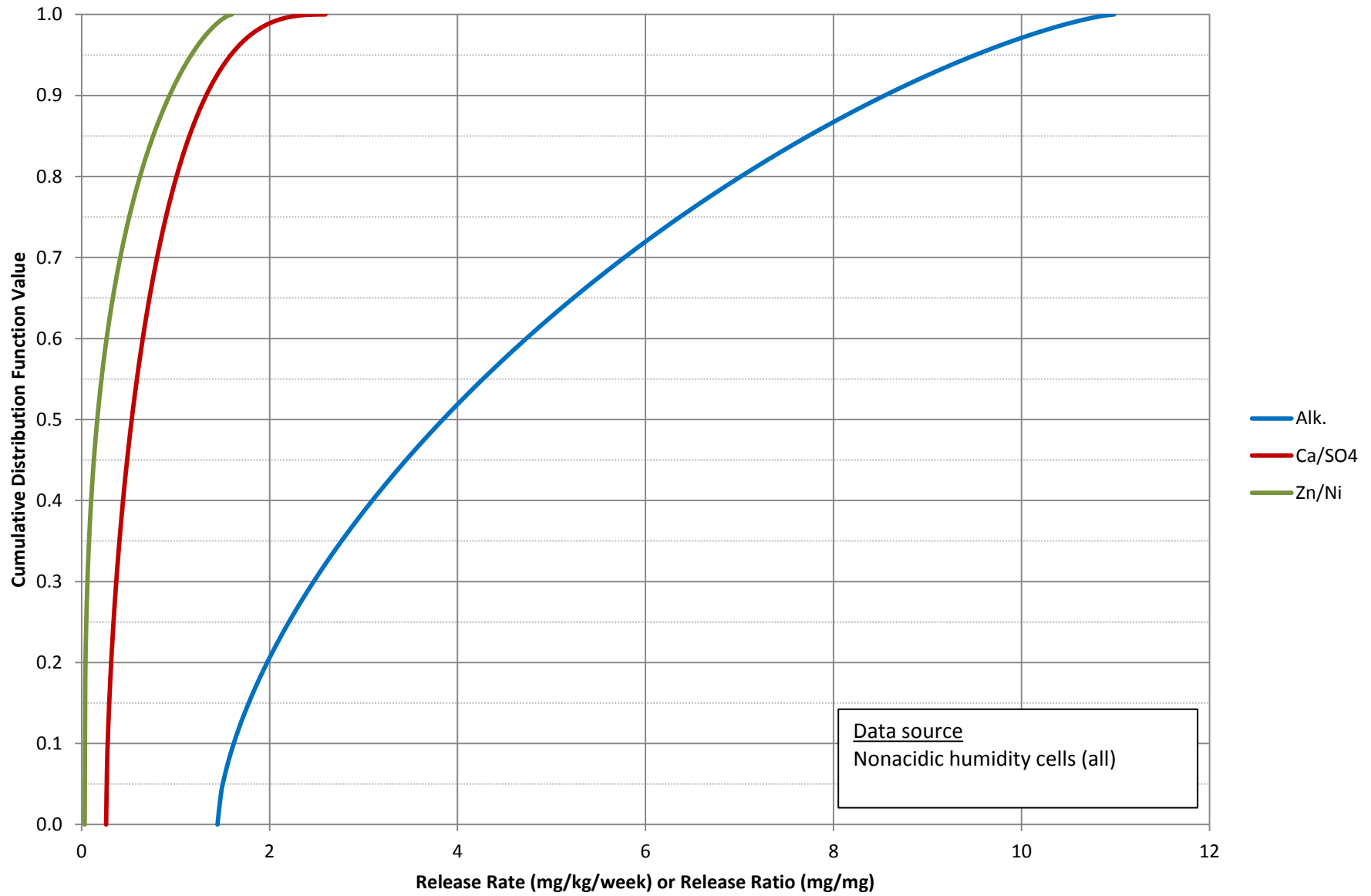

Large Figure 9

Distributions from Humidity Cells for Duluth Complex Category 4  
Waste Rock (a)

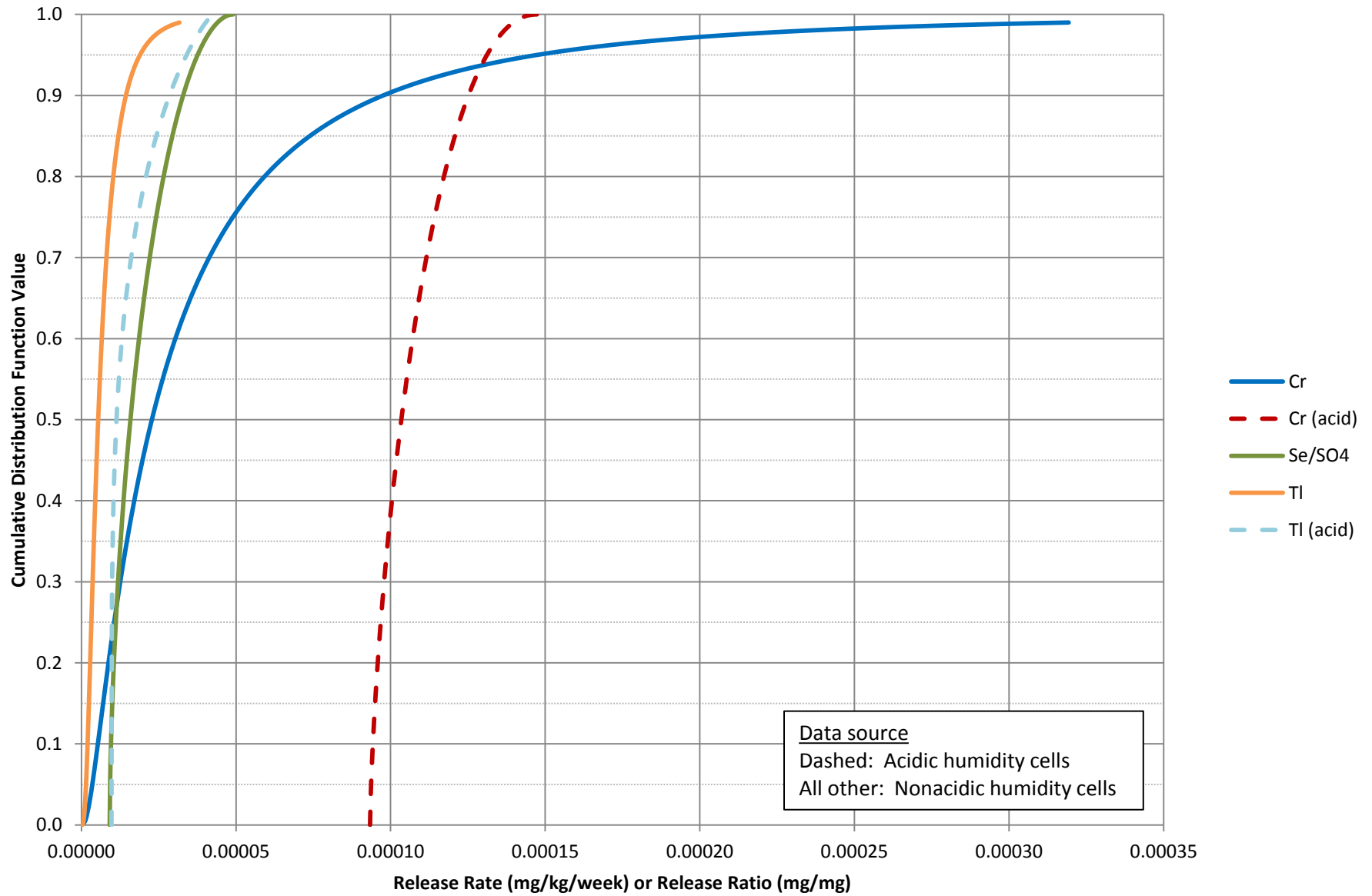

Large Figure 10

Distributions from Humidity Cells for Duluth Complex Category 4  
Waste Rock (b)

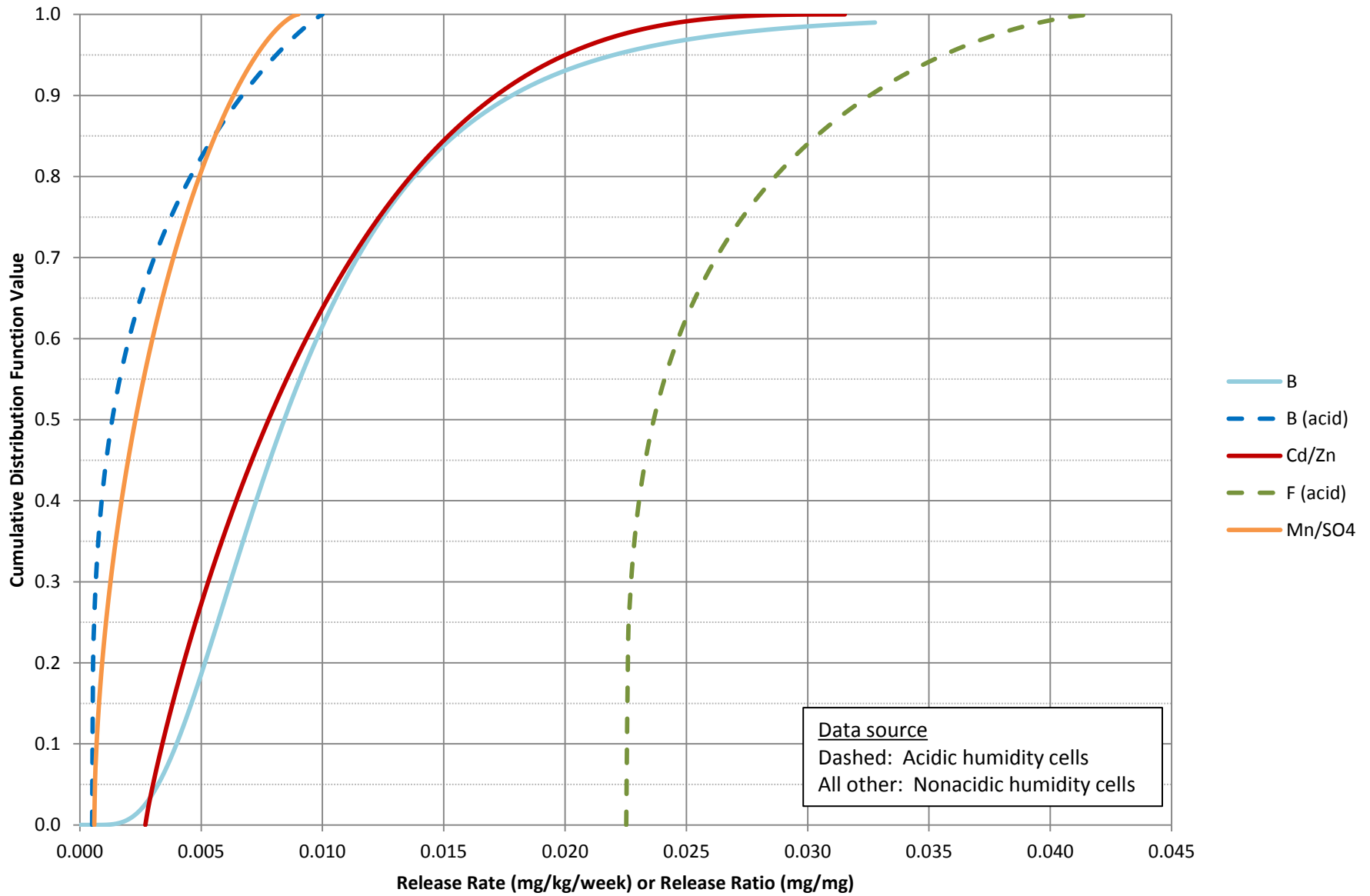

Large Figure 11

Distributions from Humidity Cells for Duluth Complex Category 4  
Waste Rock (c)

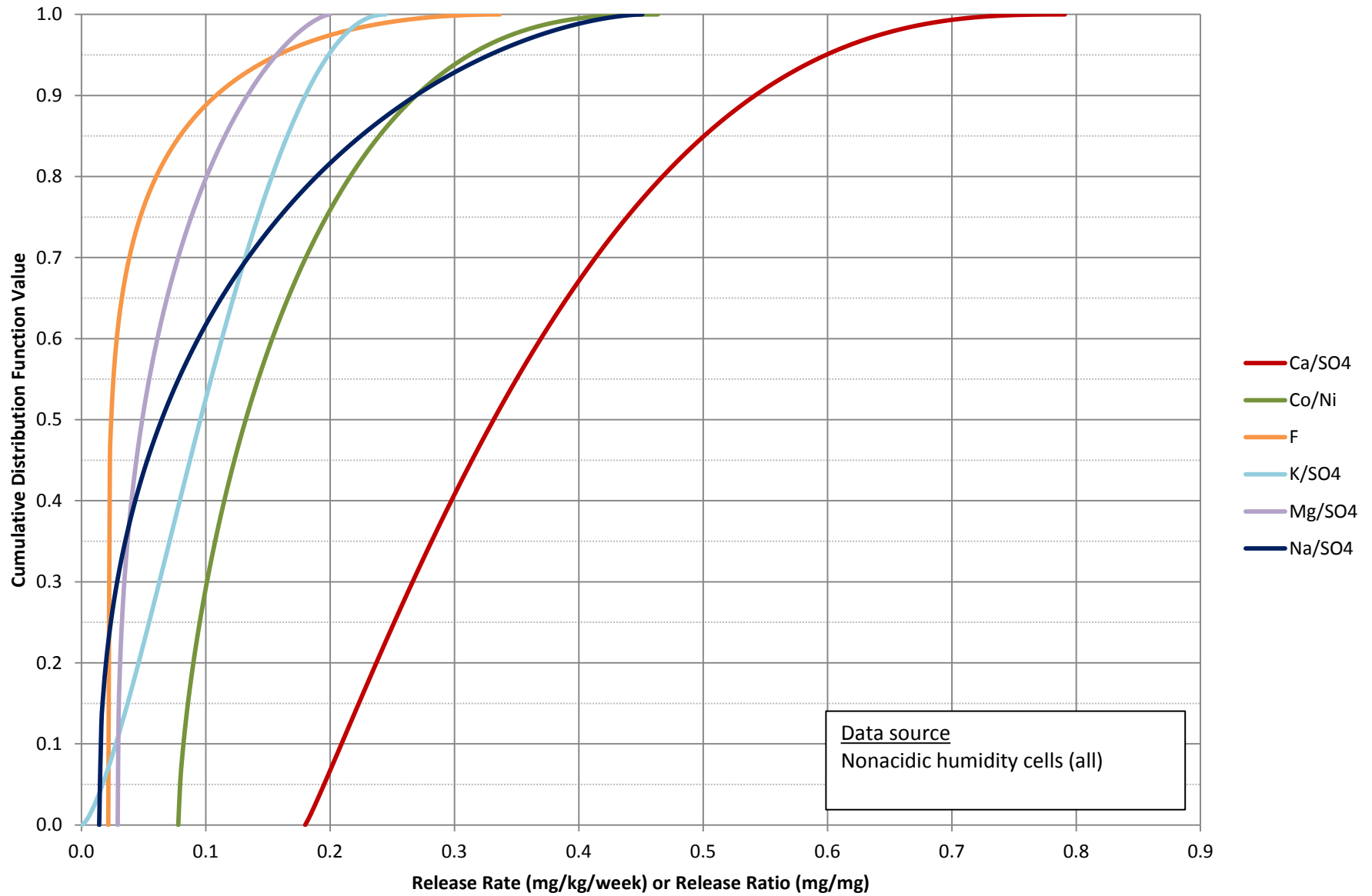



Large Figure 12

Distributions from Humidity Cells for Duluth Complex Category 4  
Waste Rock (d)

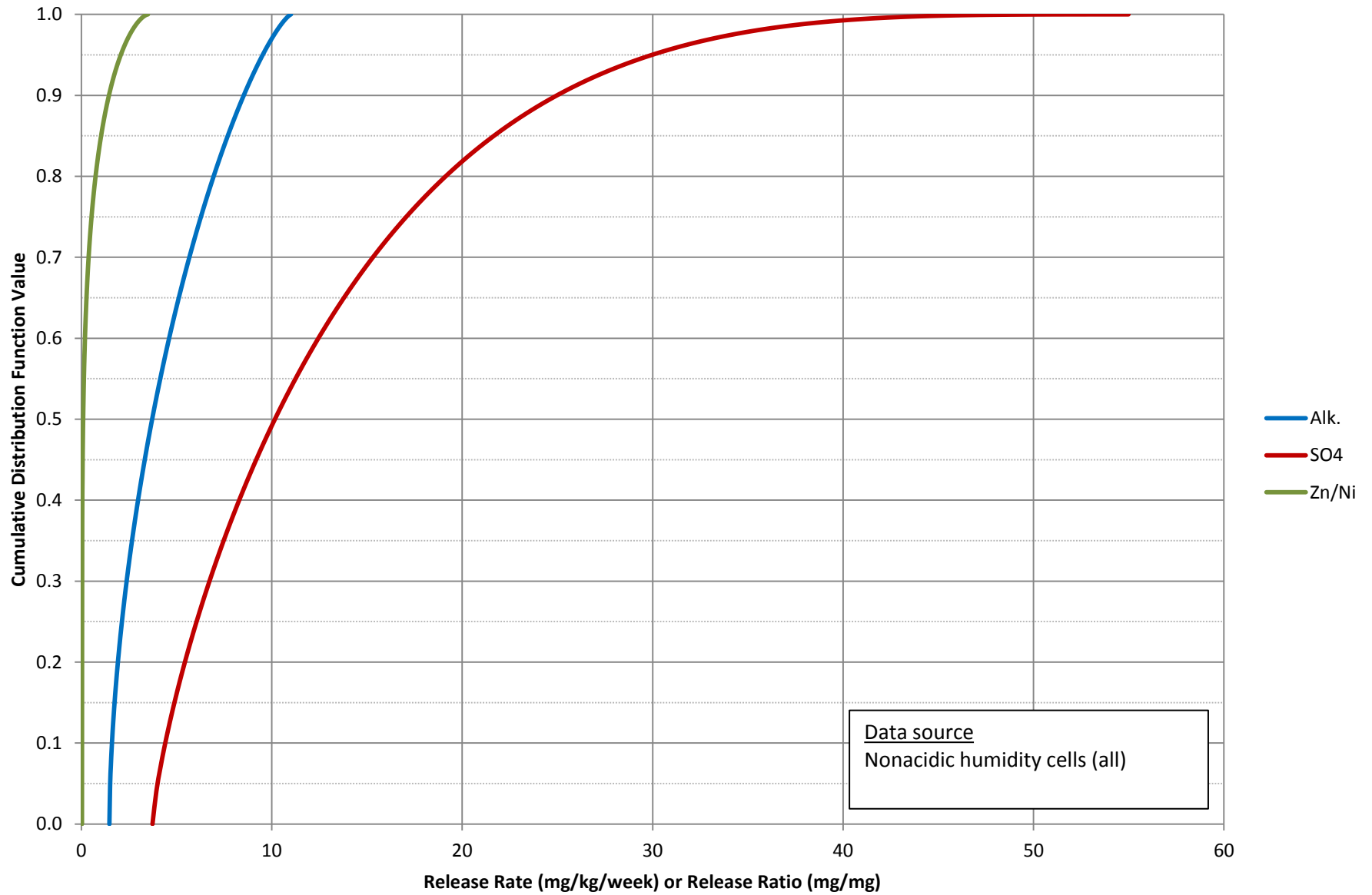

Large Figure 13

Distributions from Humidity Cells for Ore in Surge Pile (a)

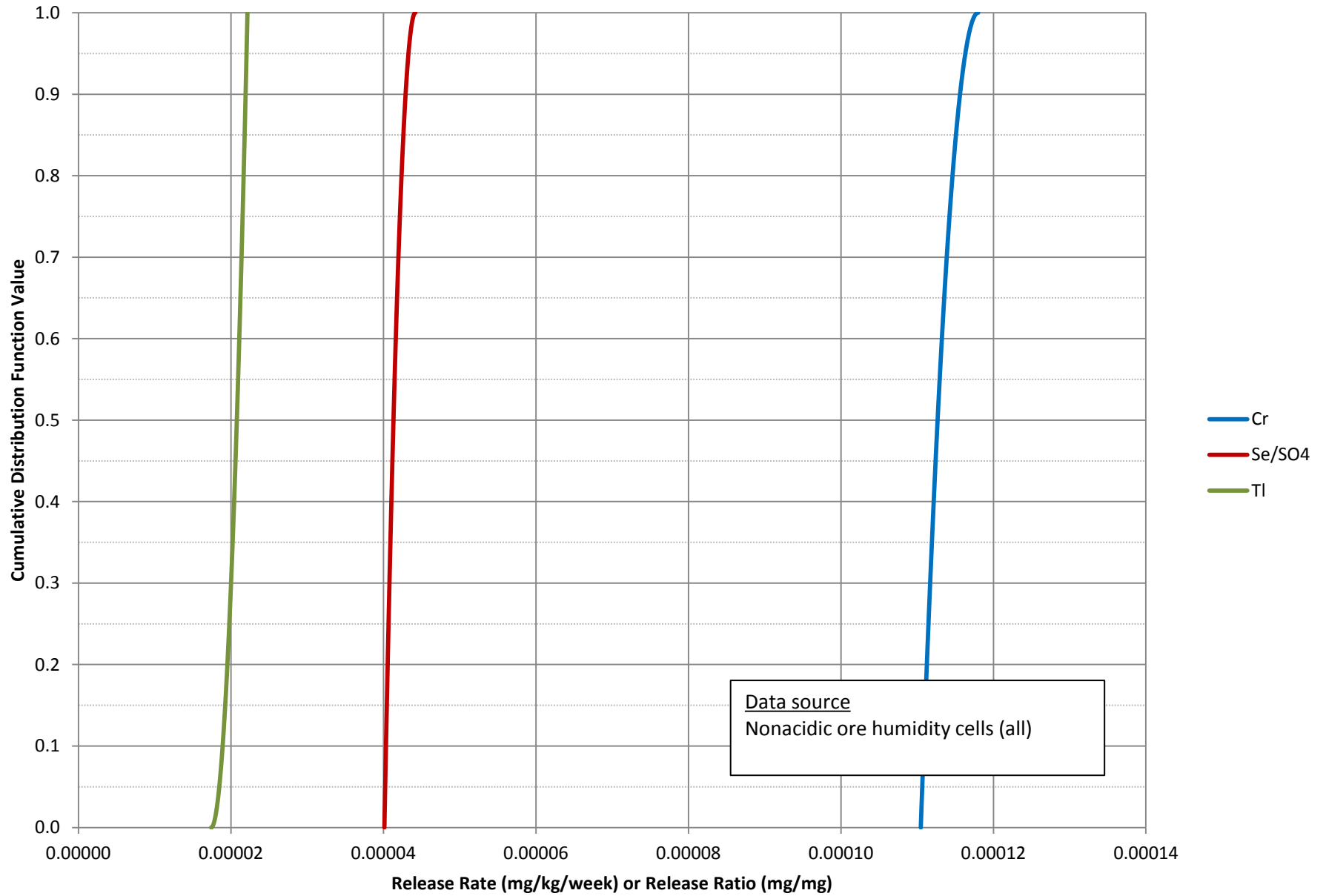

Large Figure 14

Distributions from Humidity Cells for Ore in Surge Pile (b)

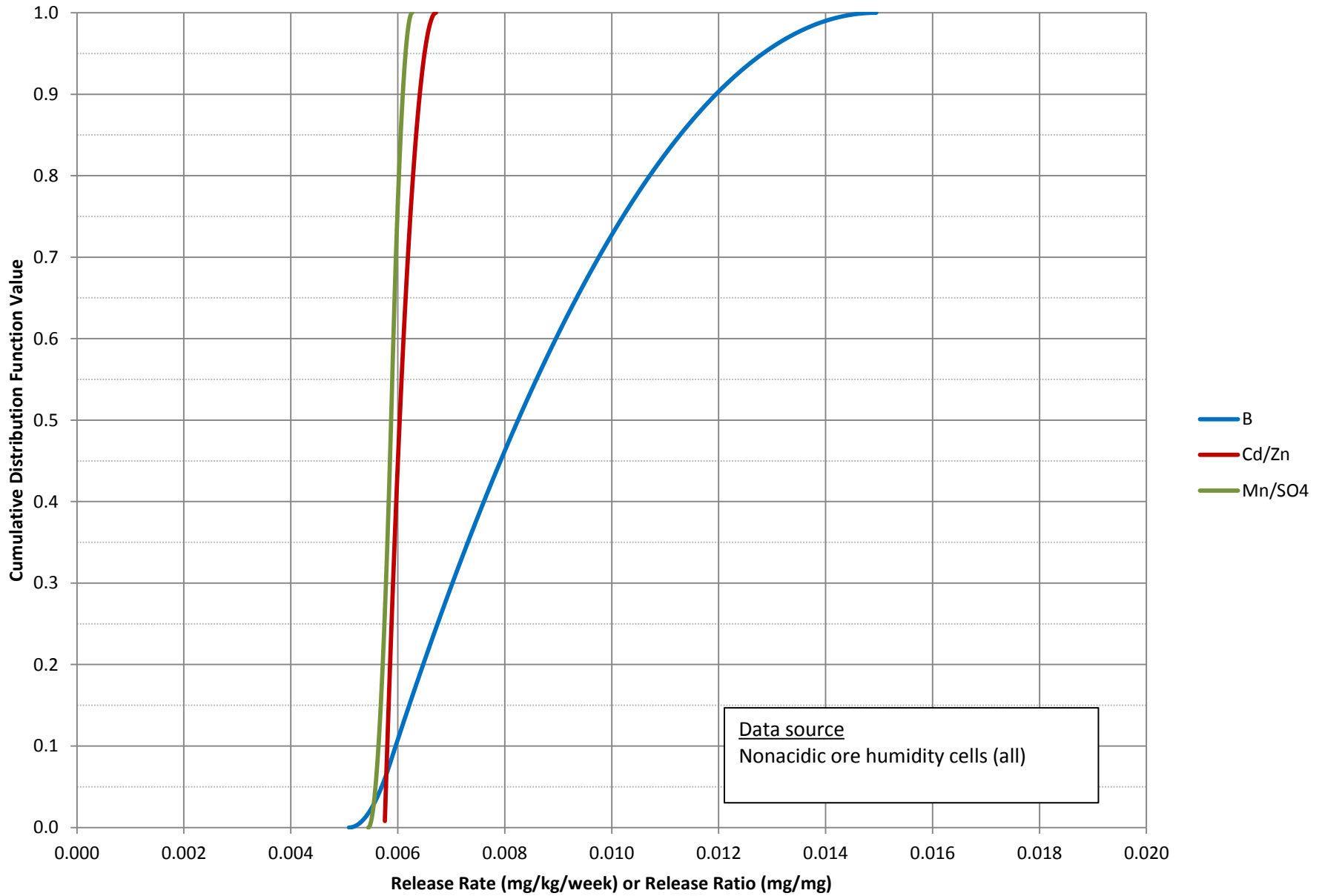

Large Figure 15

Distributions from Humidity Cells for Ore in Surge Pile (c)

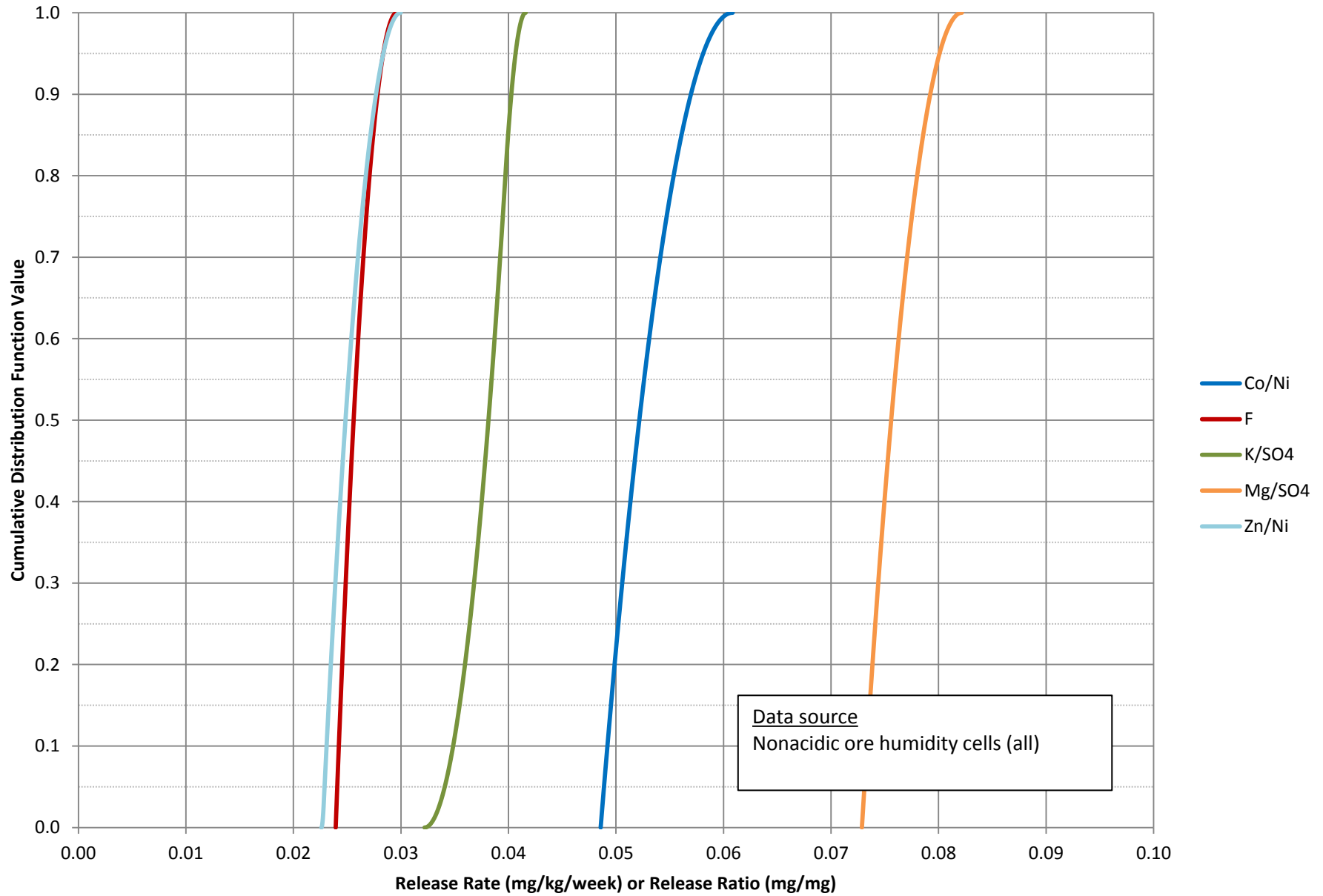

Large Figure 16

Distributions from Humidity Cells for Ore in Surge Pile (d)

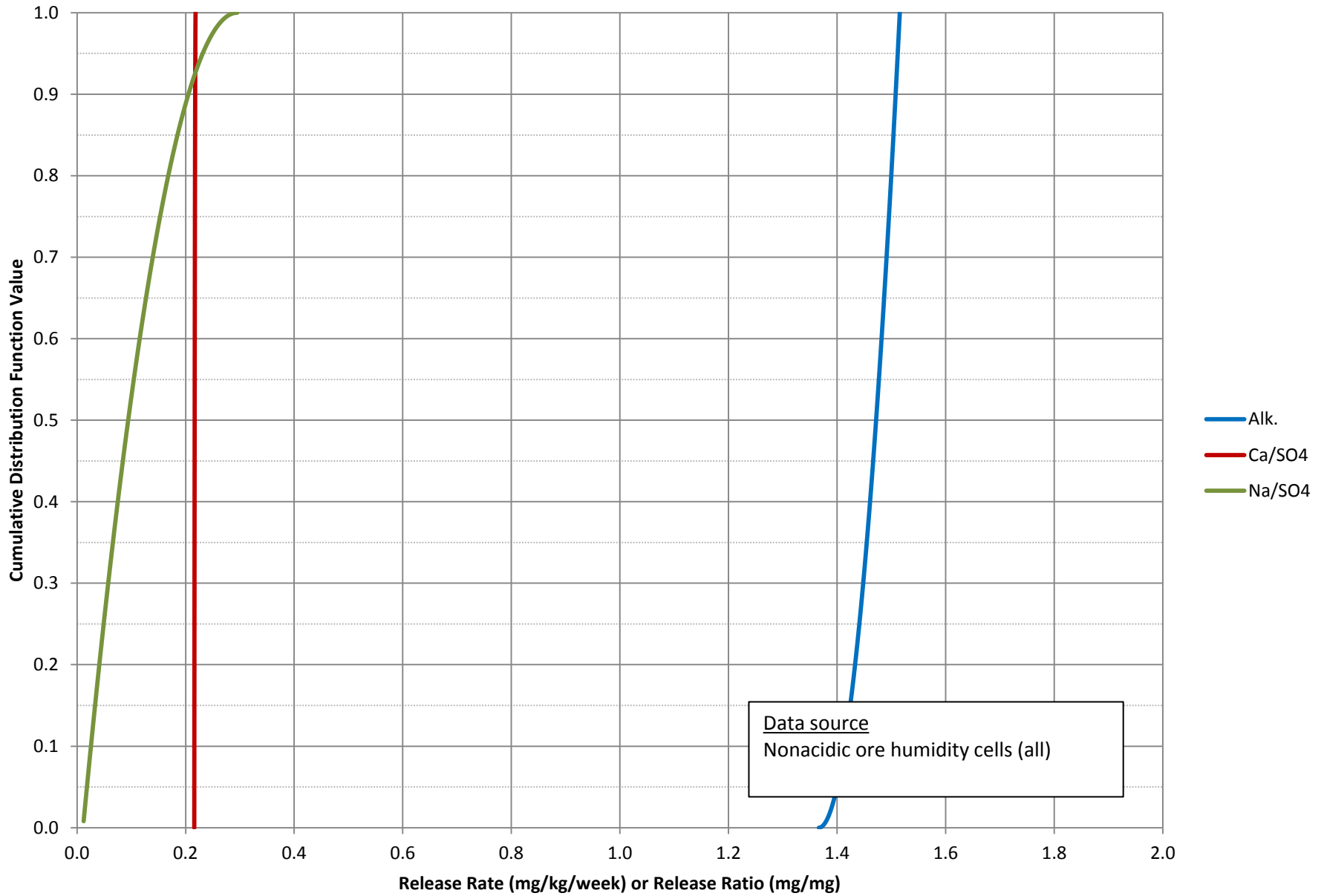

Large Figure 17

Distributions from Humidity Cells for Virginia Formation Category 4  
Waste Rock (a)

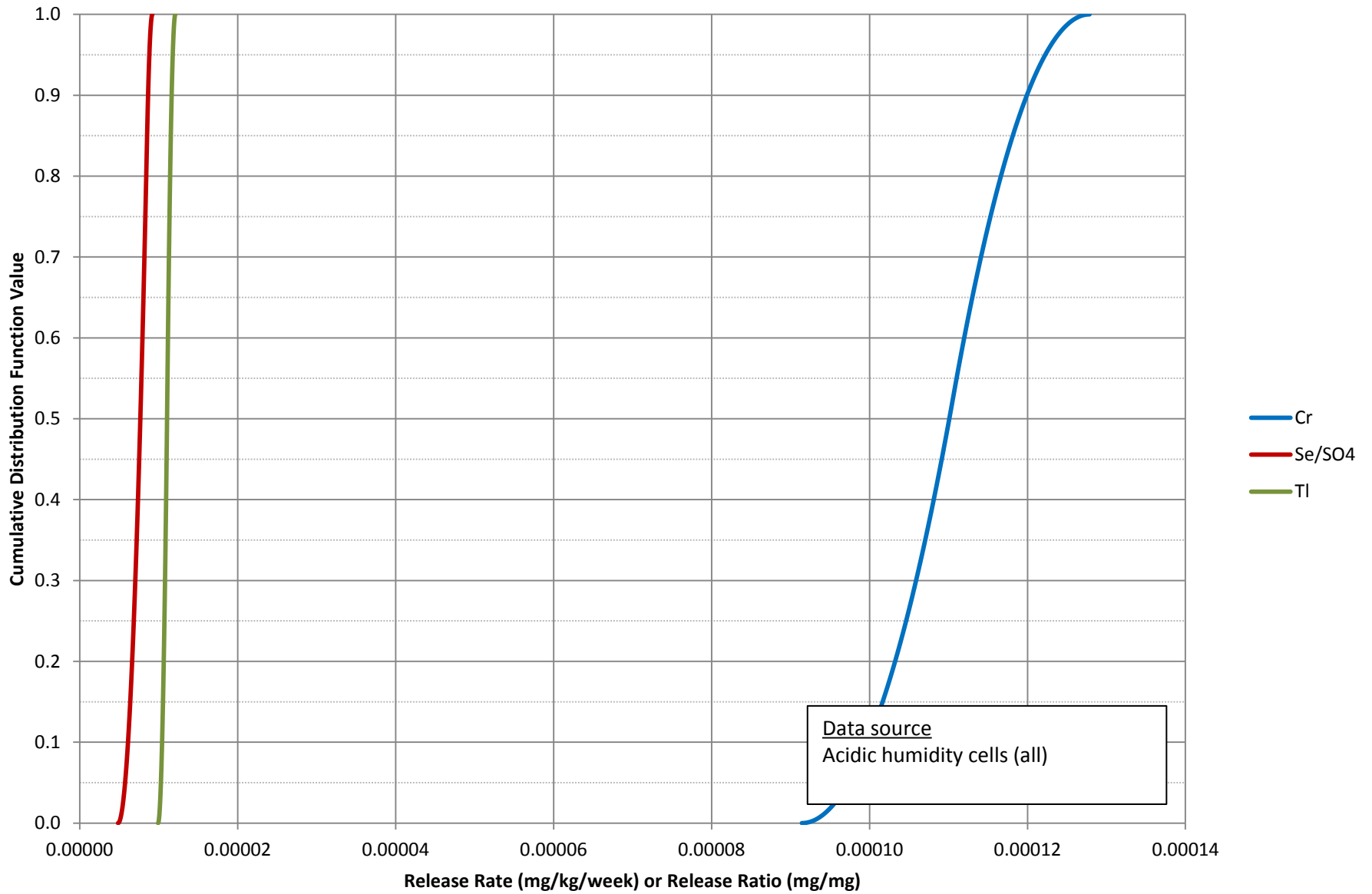

Large Figure 18

Distributions from Humidity Cells for Virginia Formation Category 4  
Waste Rock (b)

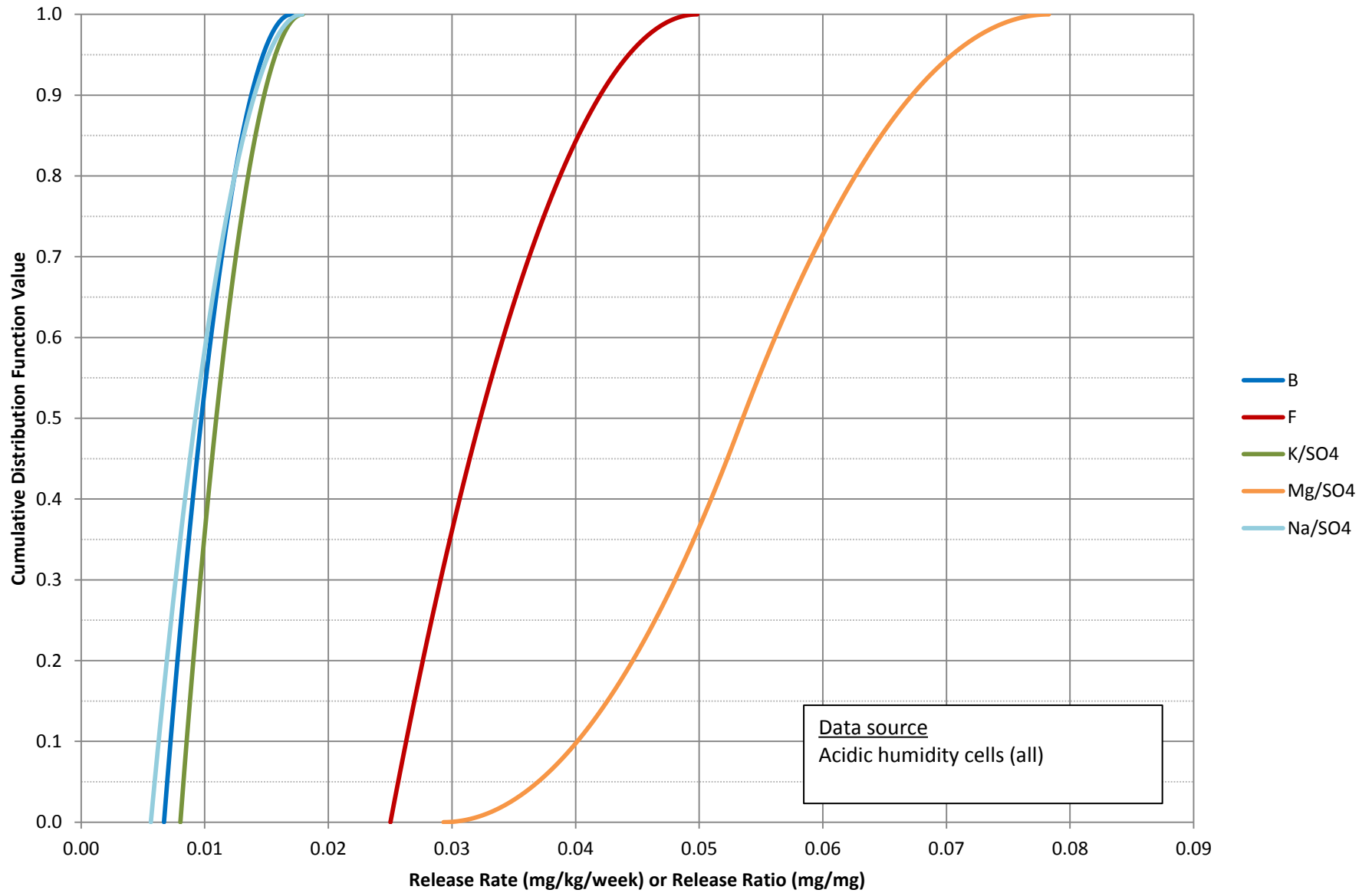

Large Figure 19

Distributions from Humidity Cells for Virginia Formation Category 4  
Waste Rock (c)

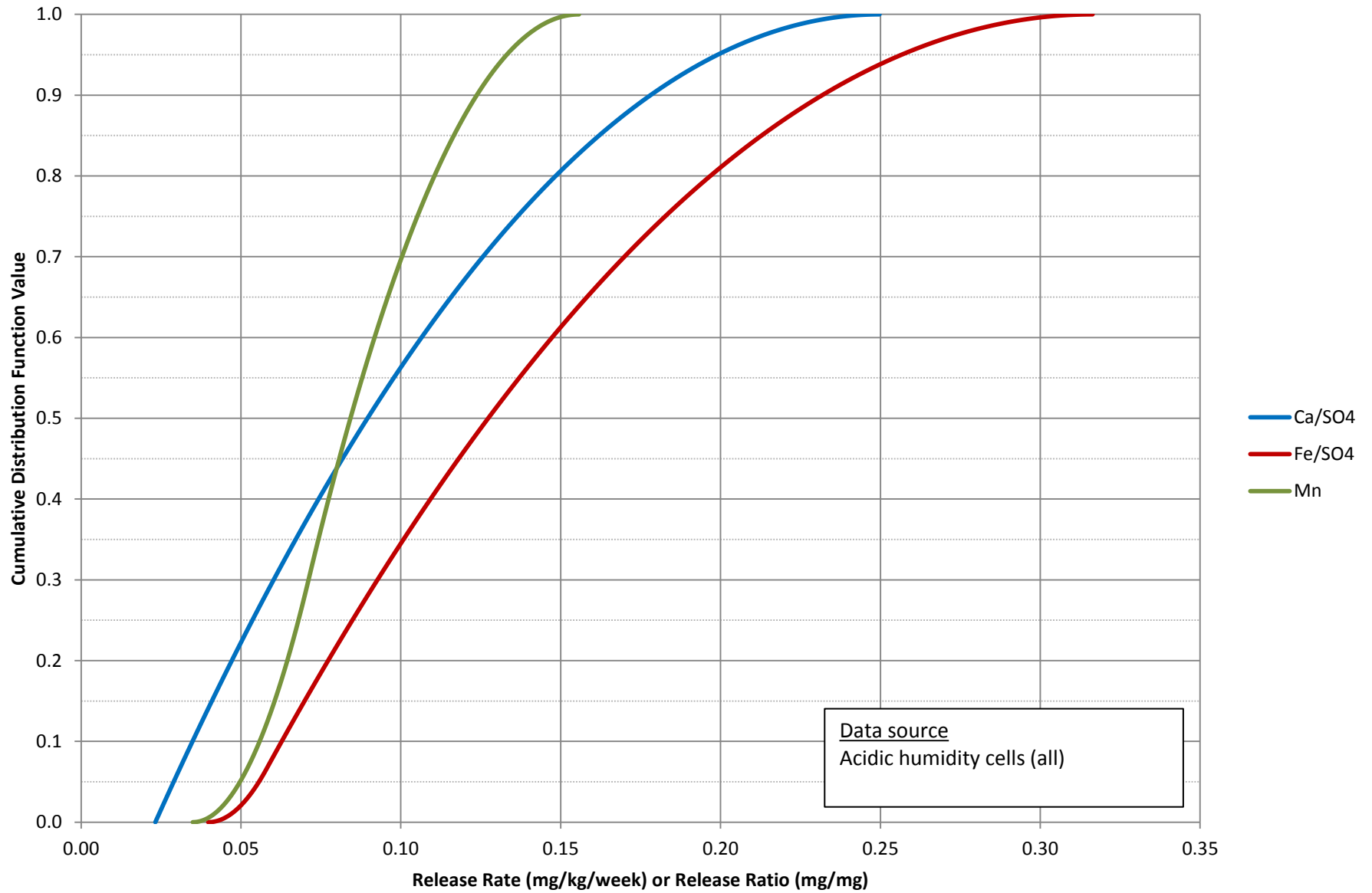



Large Figure 20

Distributions from Humidity Cells for Virginia Formation Category 4  
Waste Rock (d)

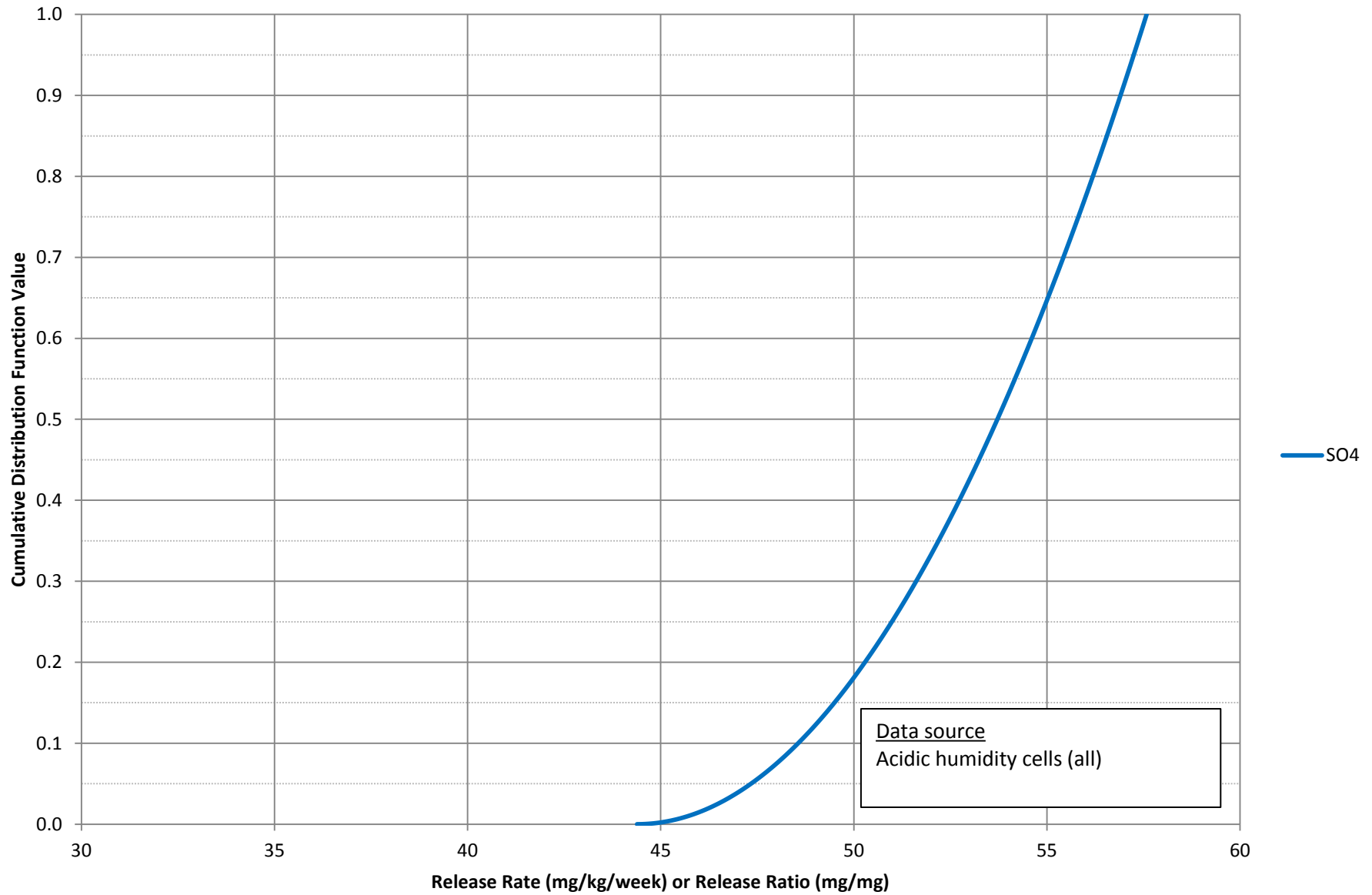

Large Figure 21

Distributions from Microprobe Data for Nickel

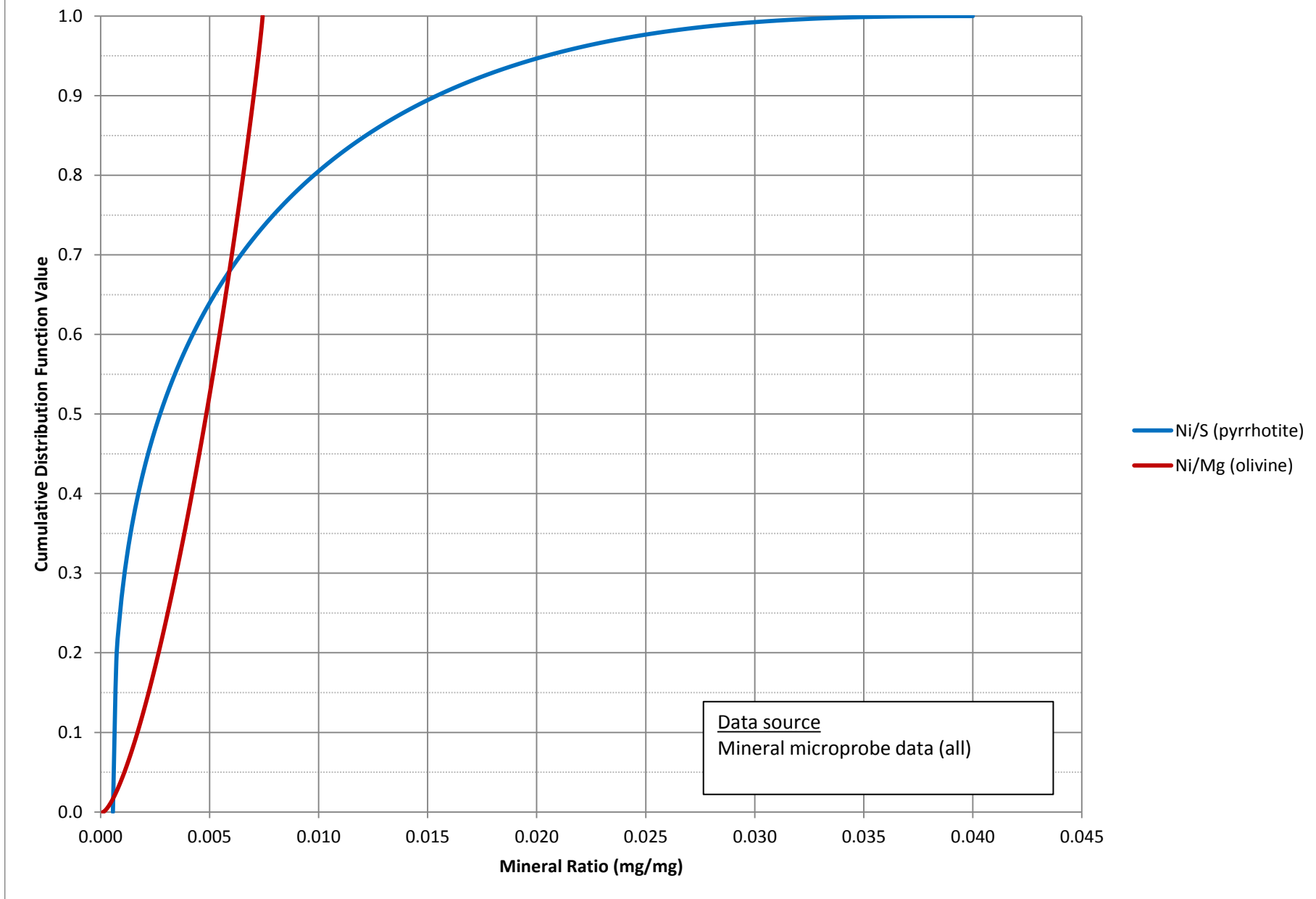

Large Figure 22

Distributions from Microprobe Data for Iron

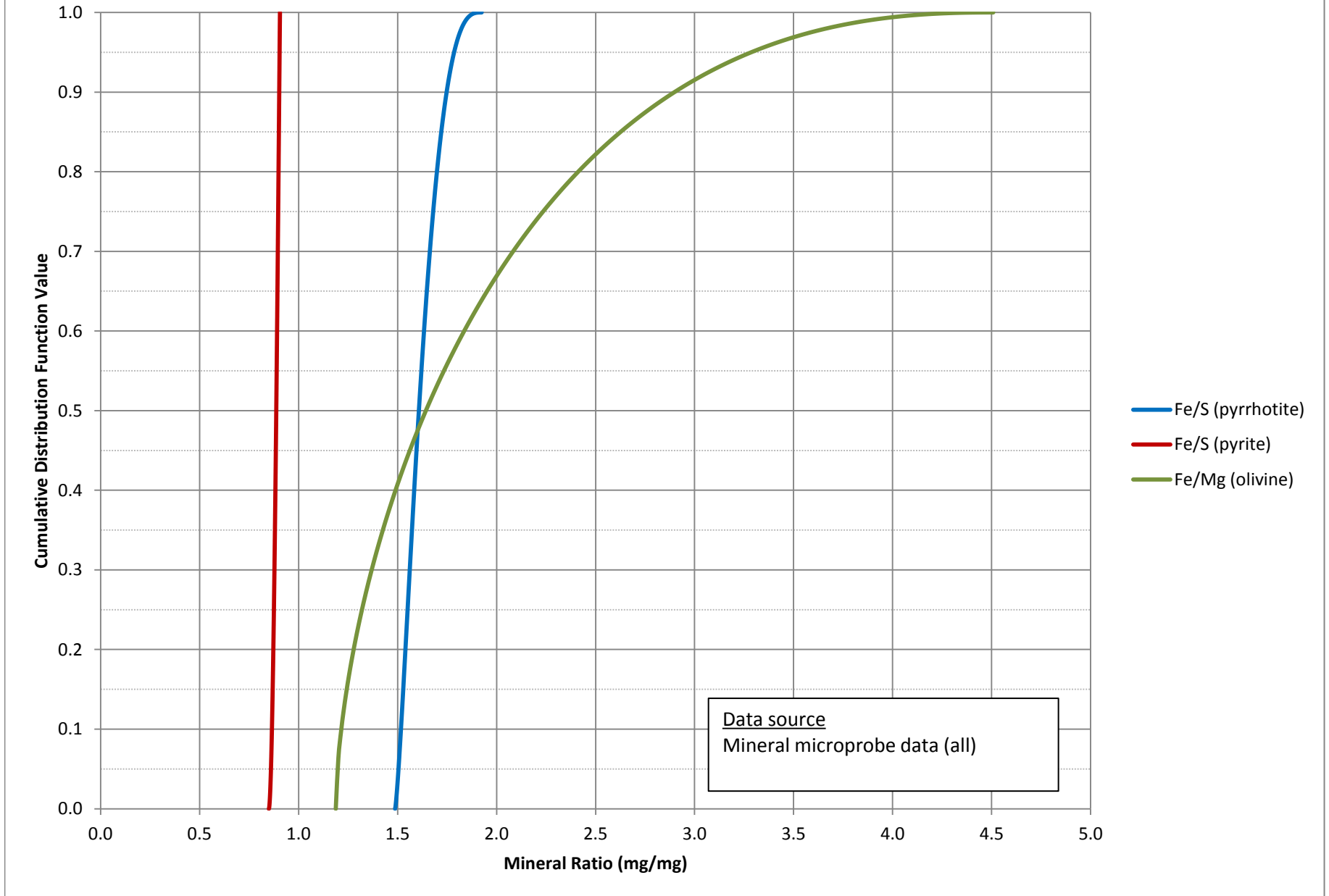

**Large Figure 23: Category 1 Concentration Cap Function (Co)**

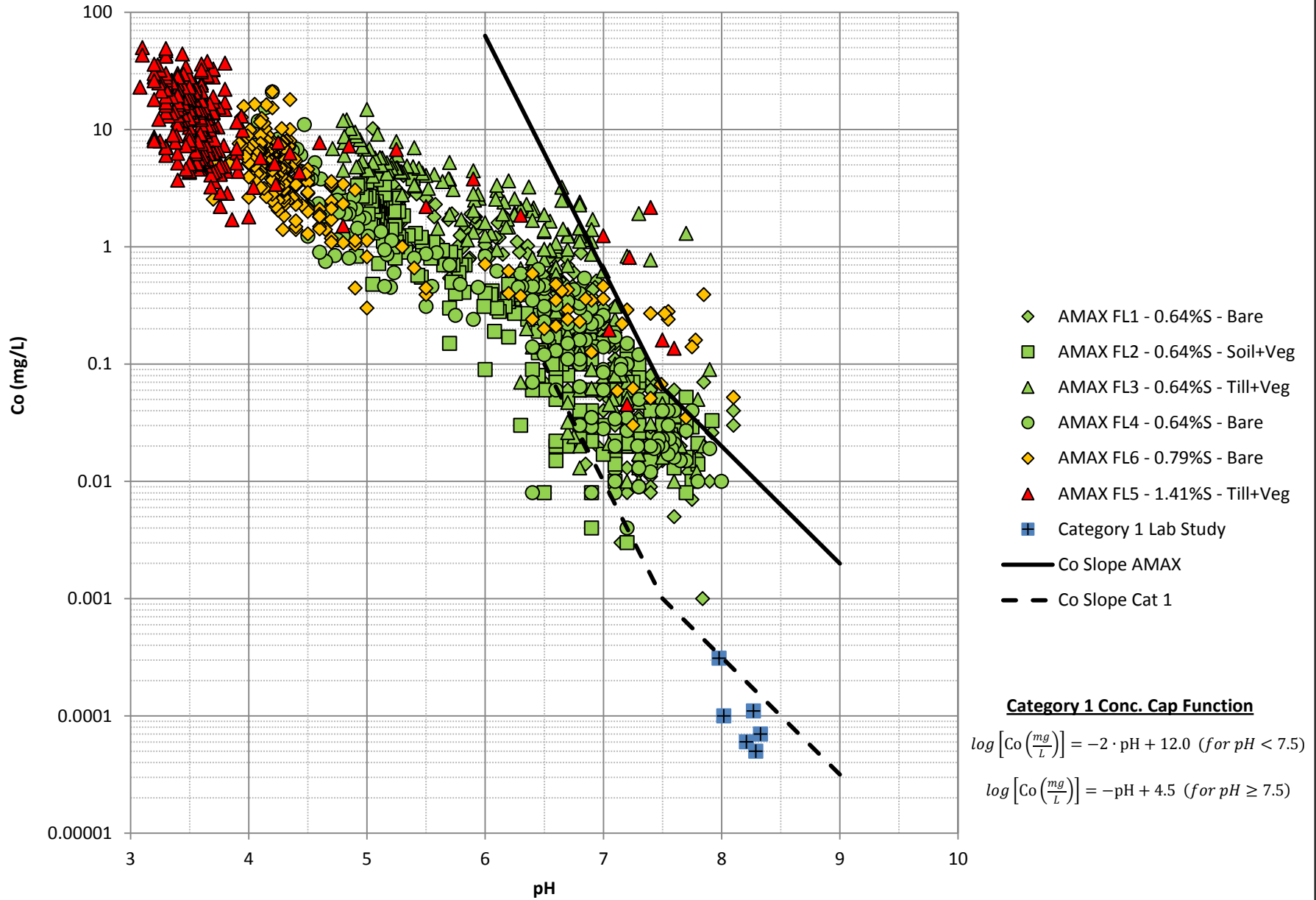

Large Figure 24: Category 1 Concentration Cap Function (Cu)

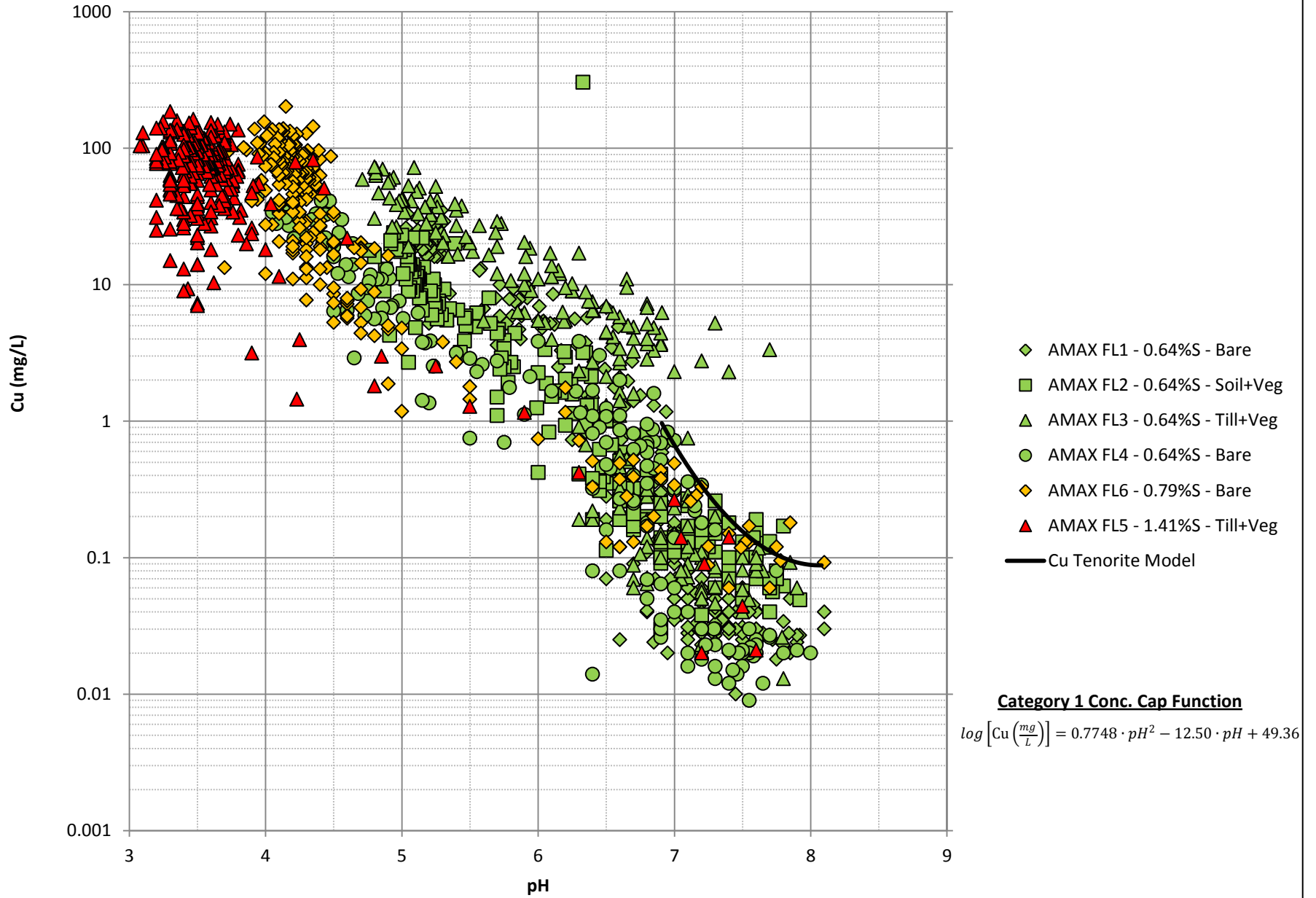

Large Figure 25: Category 1 Concentration Cap Function (Mn)

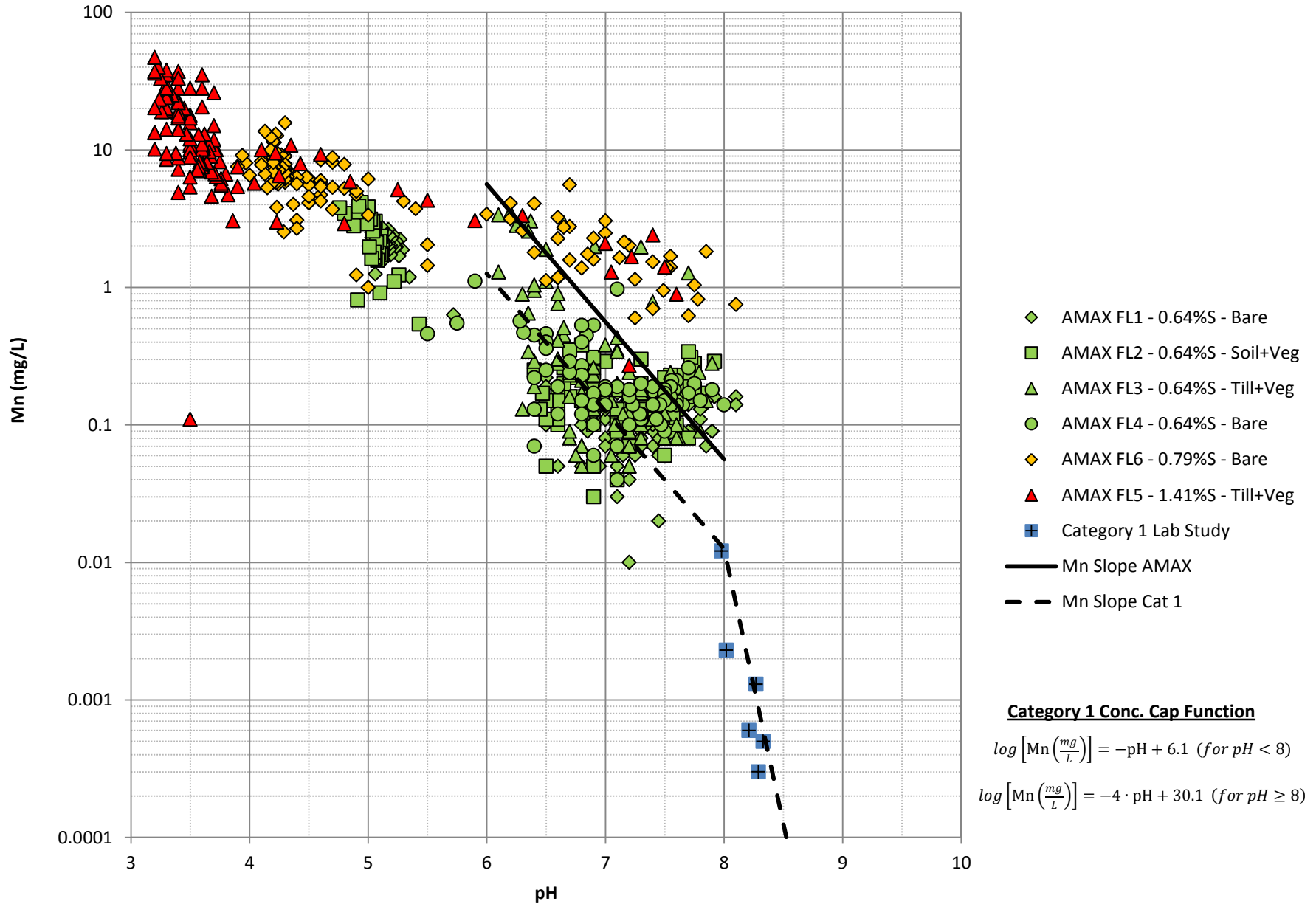

Large Figure 26: Category 1 Concentration Cap Function (Ni)

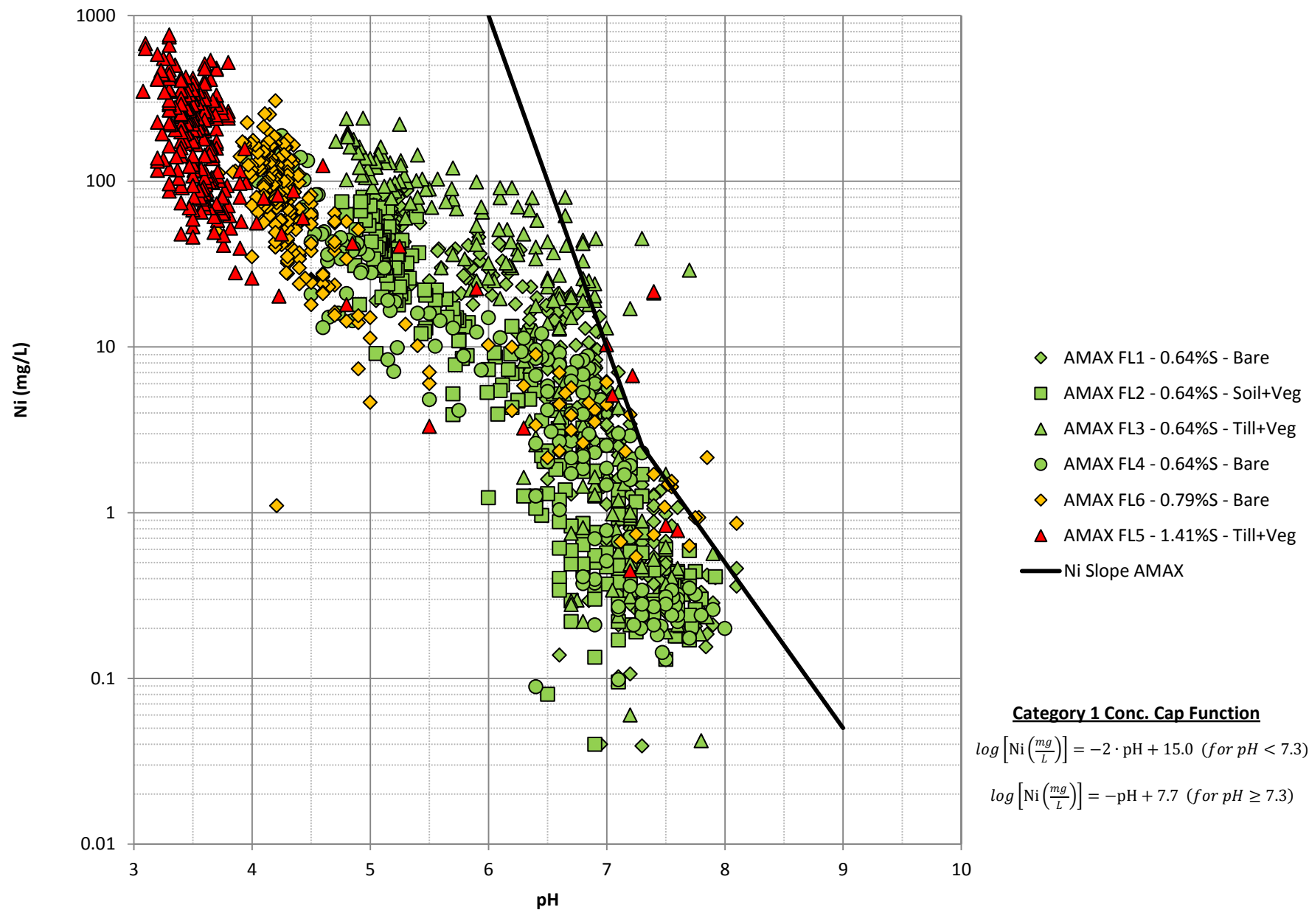

Large Figure 27: Category 1 Concentration Cap Function (Zn)

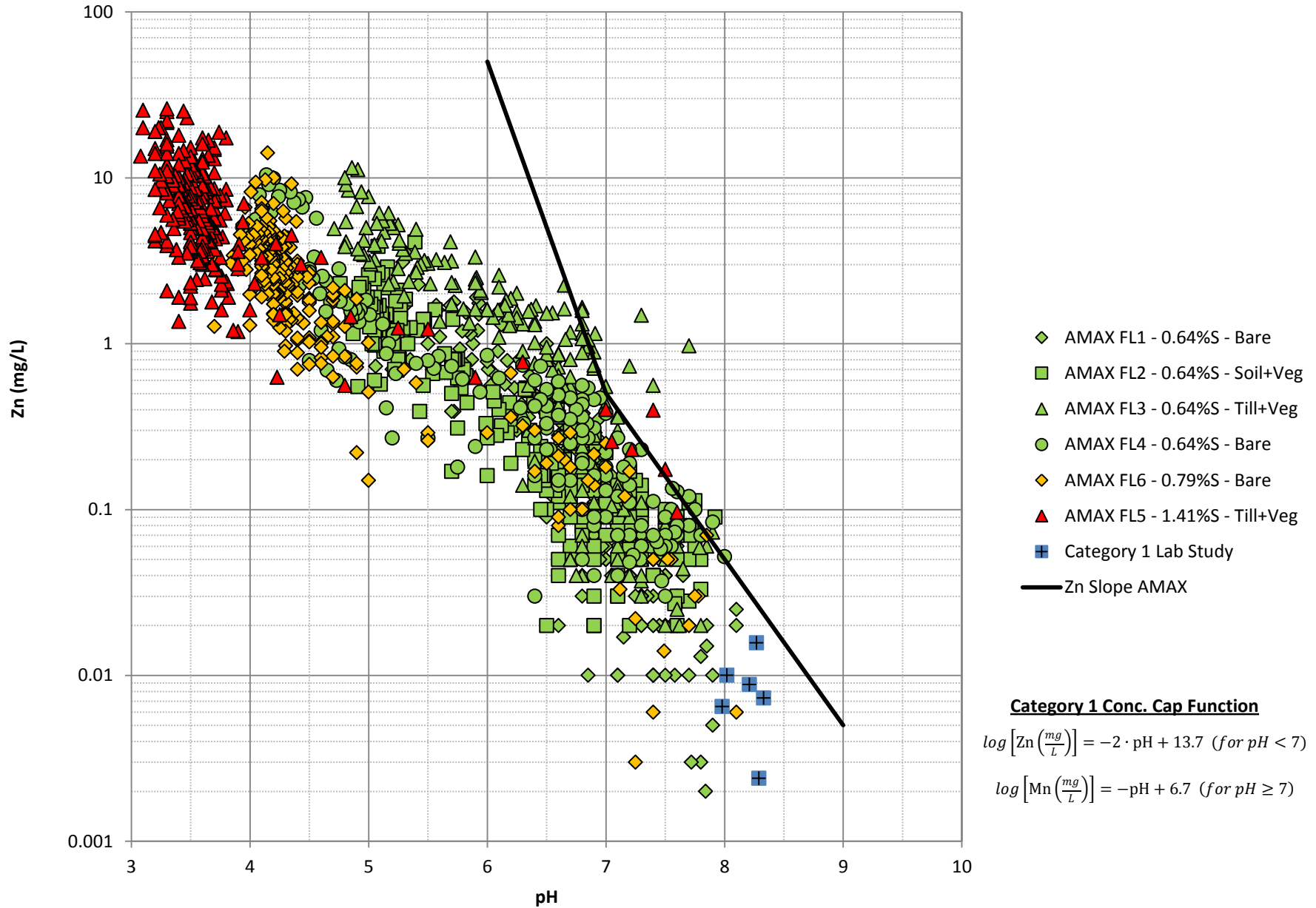



Large Figure 28

Distributions for Duluth Complex Category 2/3, 4 and Ore Concentration Caps (nonacidic) (a)

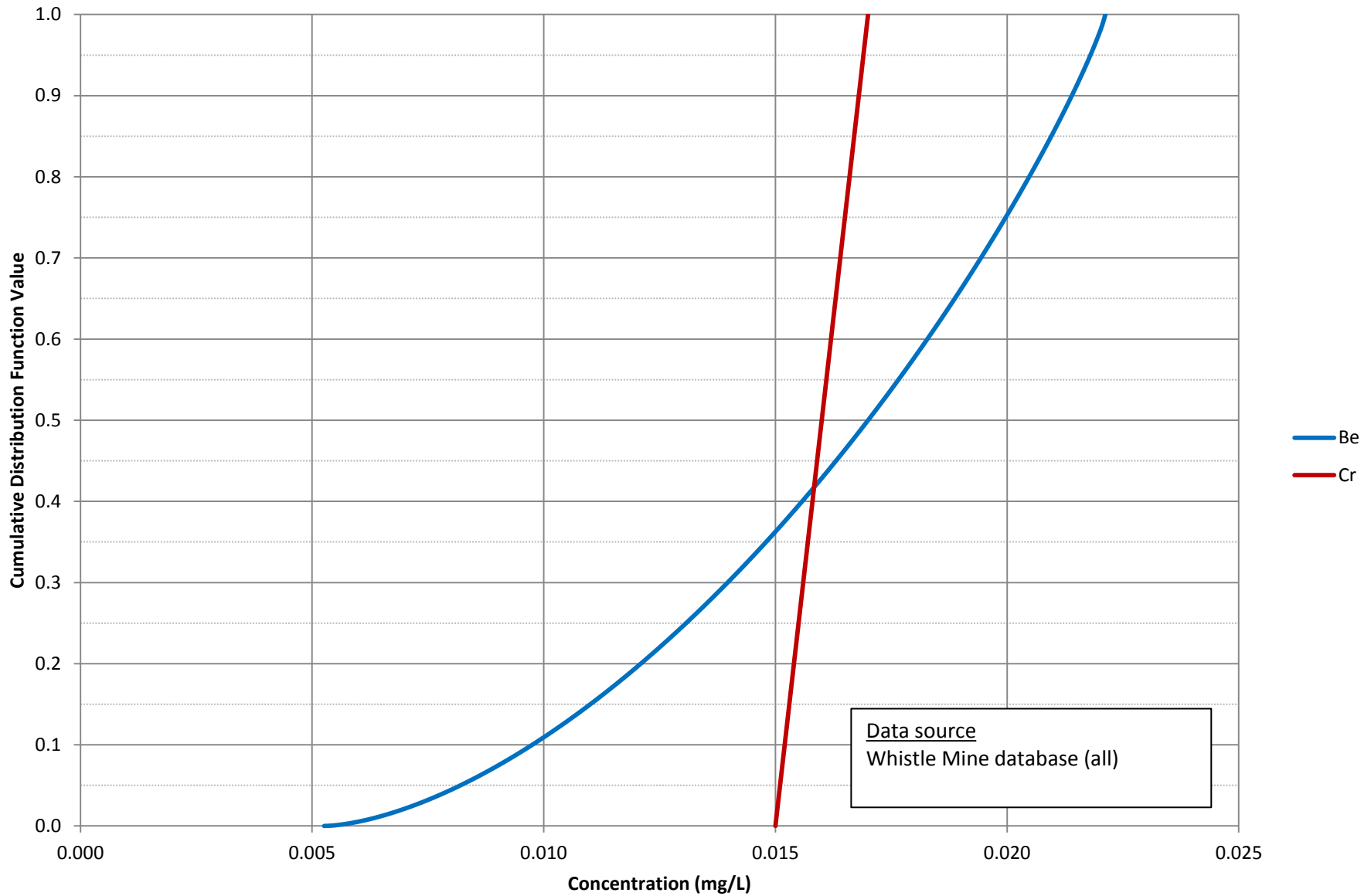

Large Figure 29

Distributions for Duluth Complex Category 2/3, 4 and Ore Concentration Caps (nonacidic) (b)

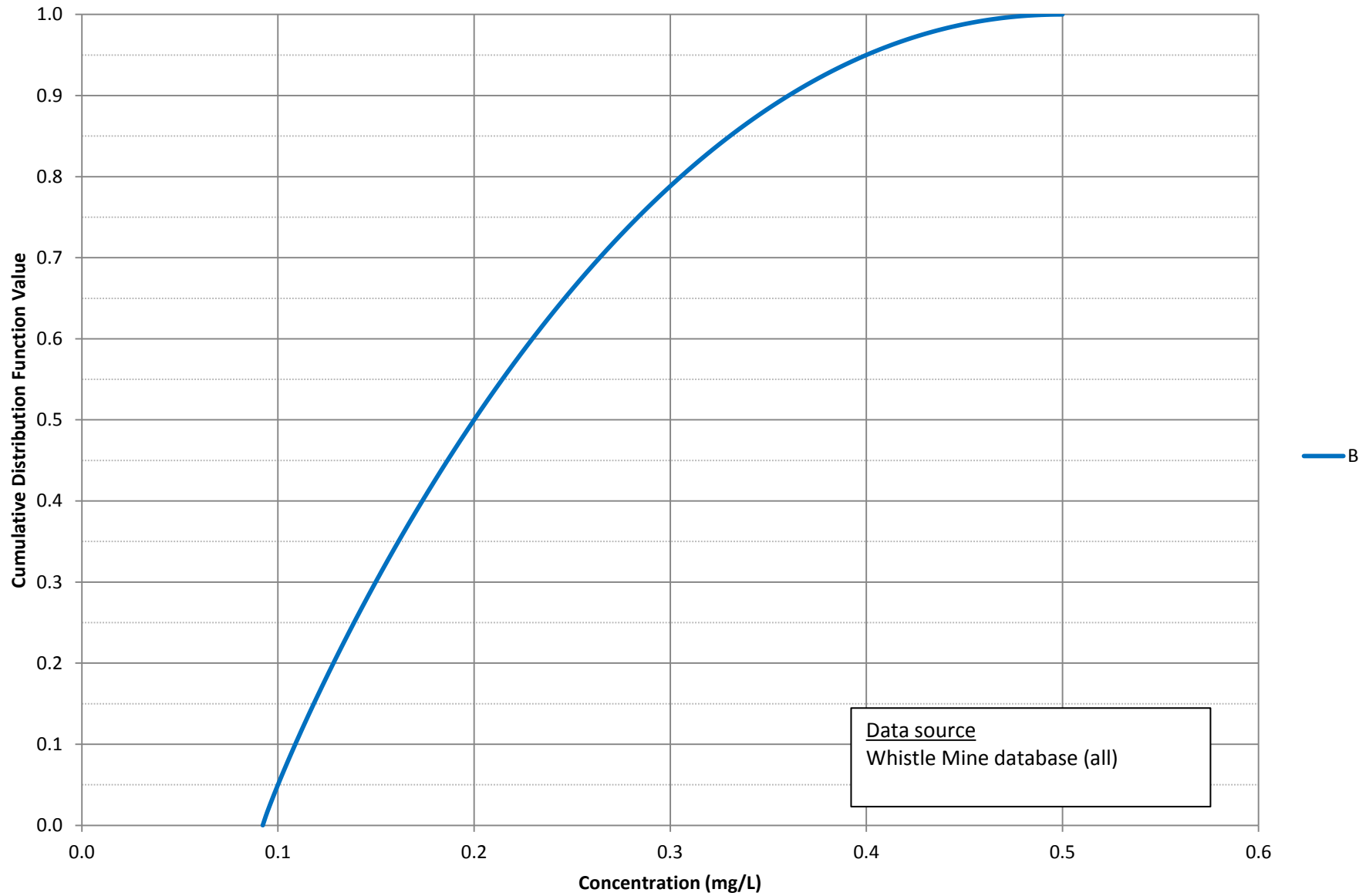

Large Figure 30

Distributions for Duluth Complex Category 2/3, 4 and Ore Concentration Caps (nonacidic) (c)

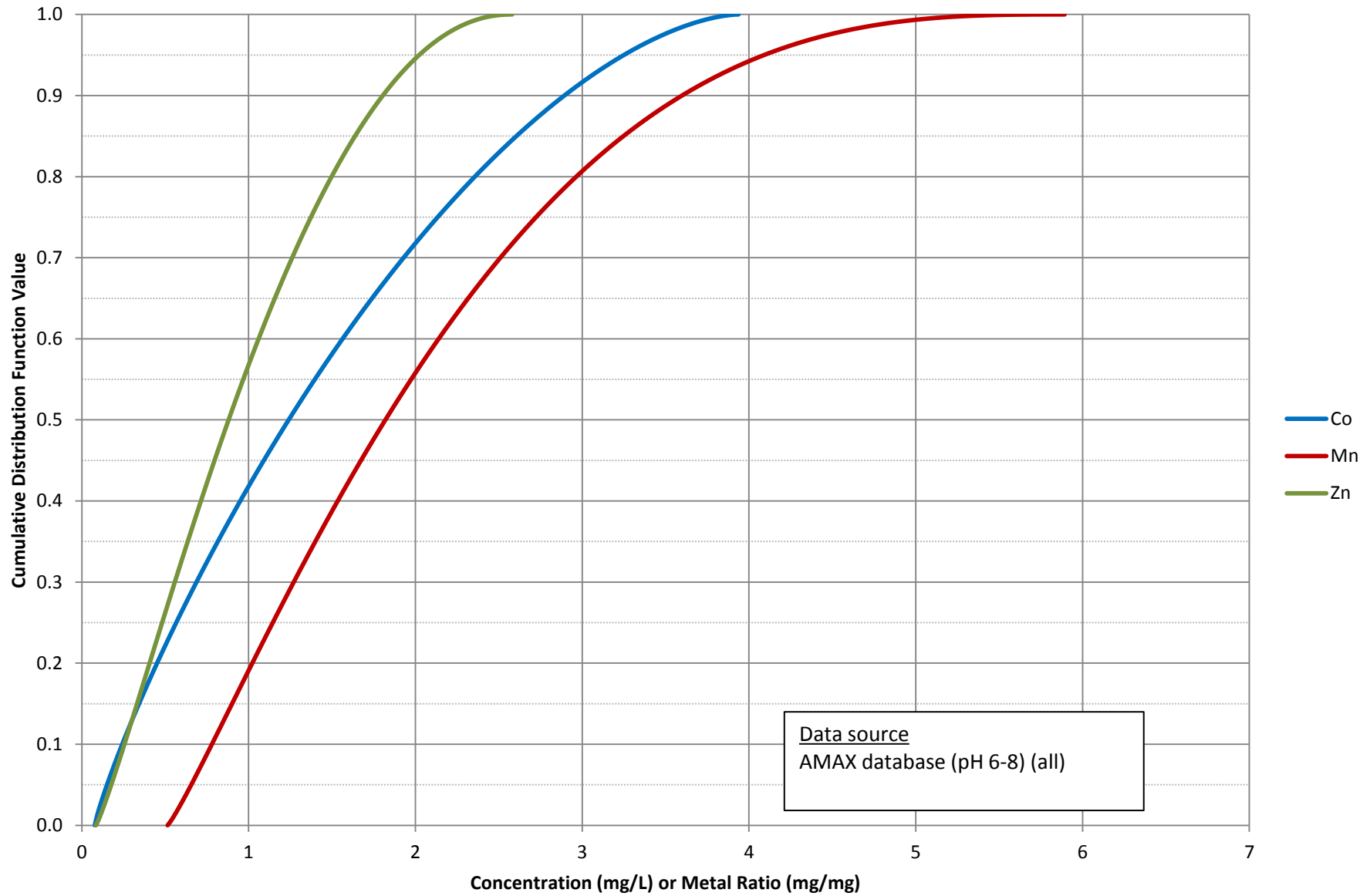

Large Figure 31

Distributions for Duluth Complex Category 2/3, 4 and Ore Concentration Caps (nonacidic) (d)

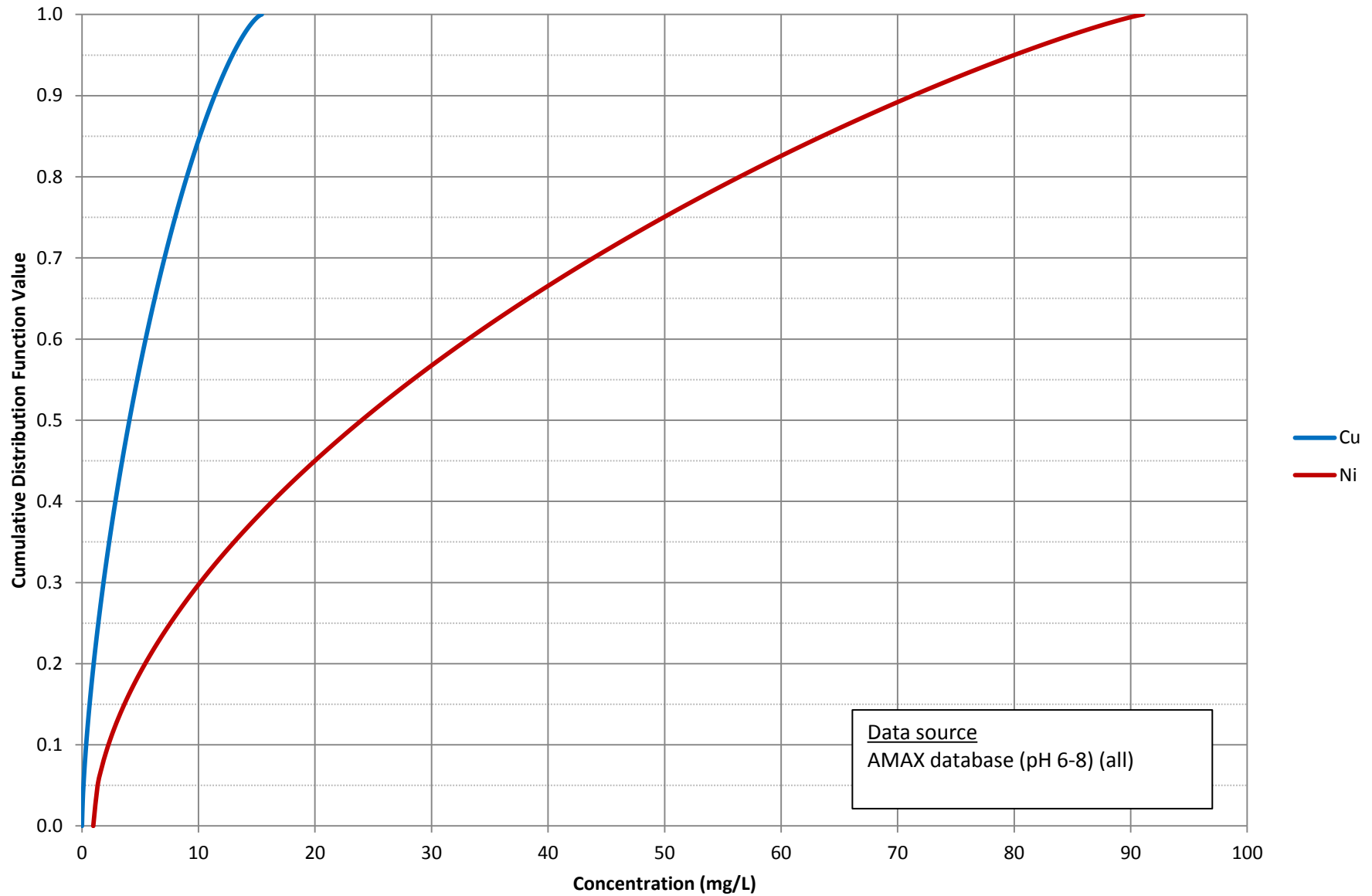

Large Figure 32

Distributions for Duluth Complex Category 2/3, 4 and Ore Concentration Caps (acidic) (a)

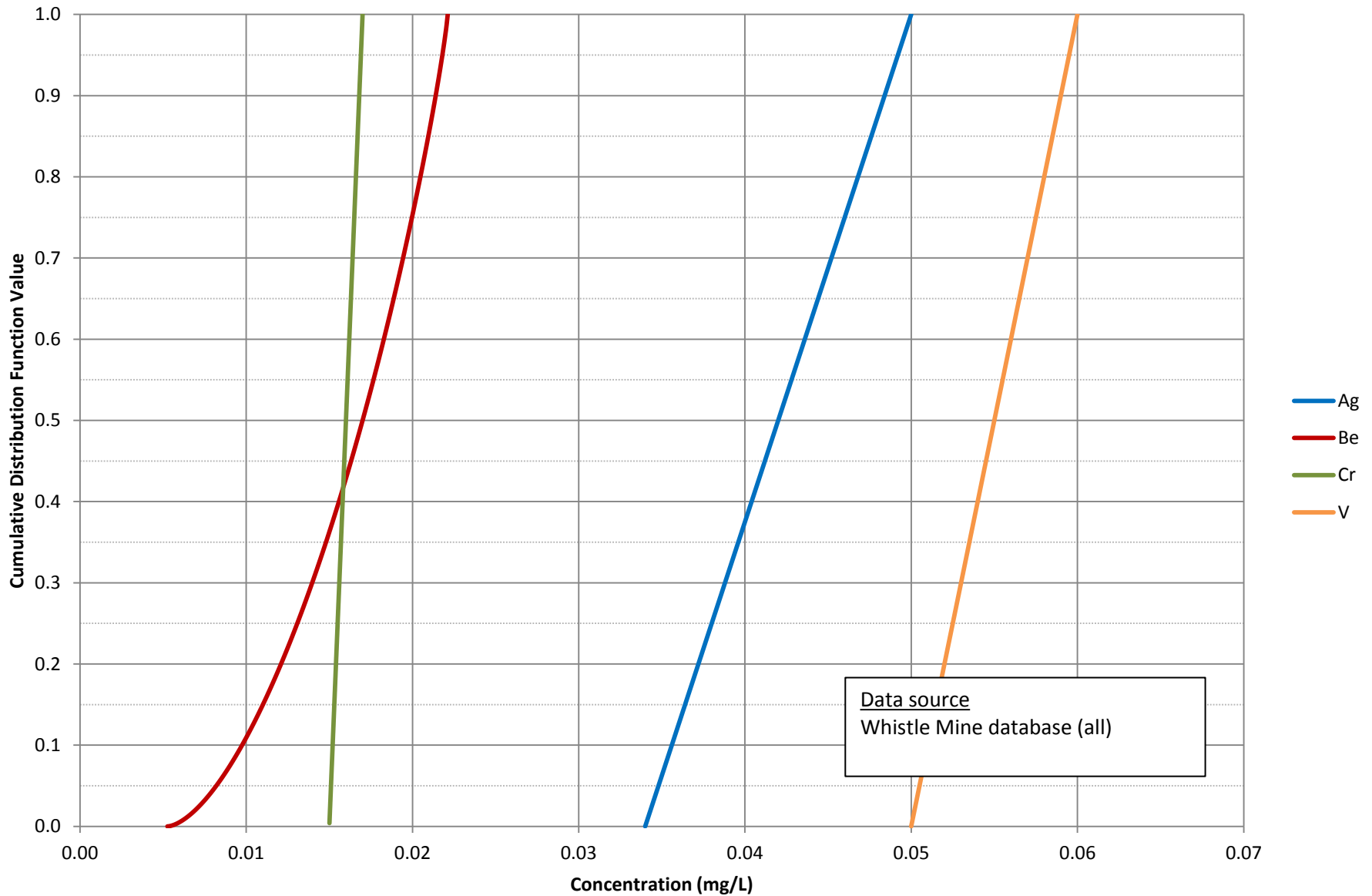

Large Figure 33

Distributions for Duluth Complex Category 2/3, 4 and Ore Concentration Caps (acidic) (b)

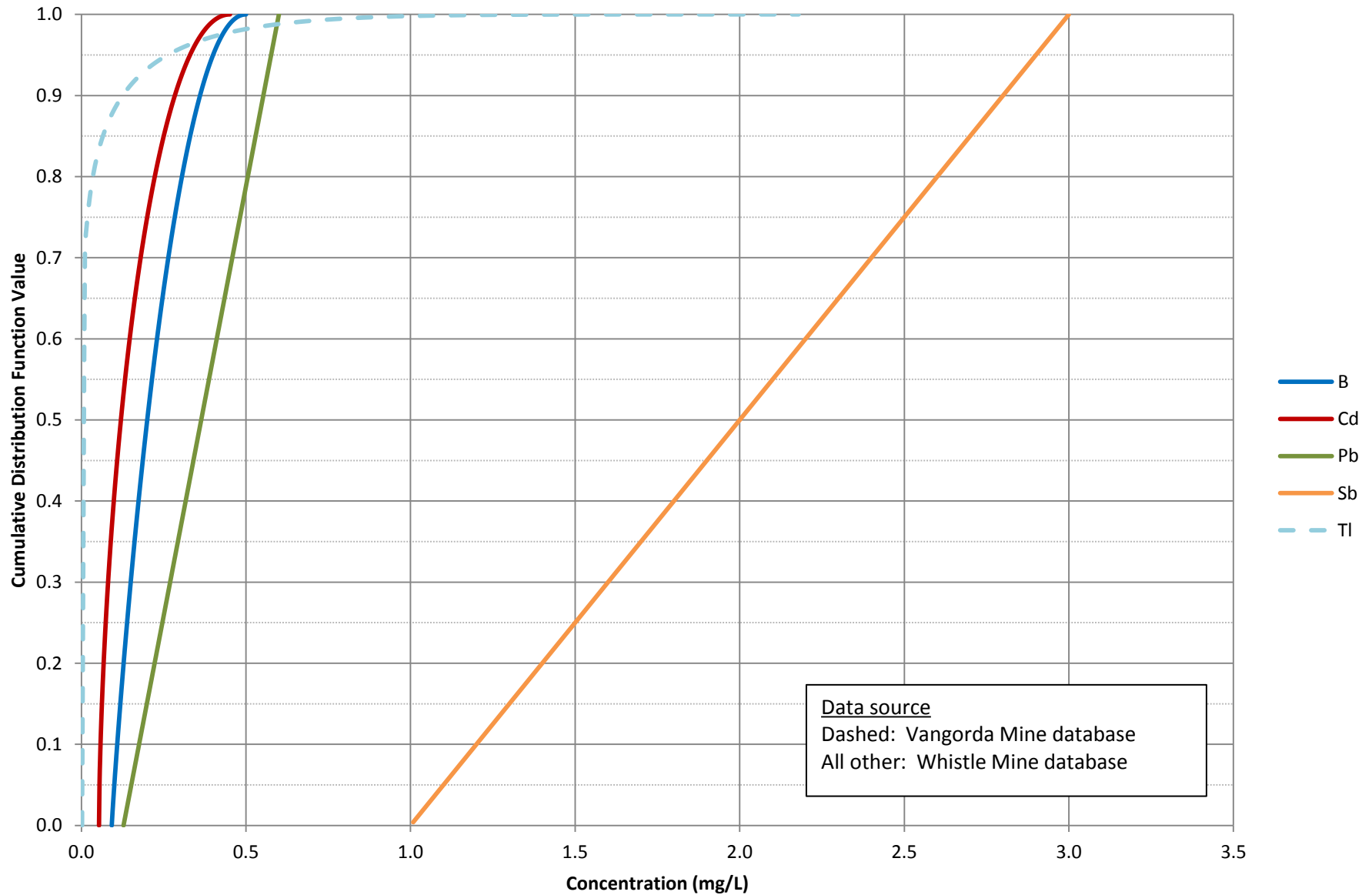

Large Figure 34

Distributions for Duluth Complex Category 2/3, 4 and Ore Concentration Caps (acidic) (c)

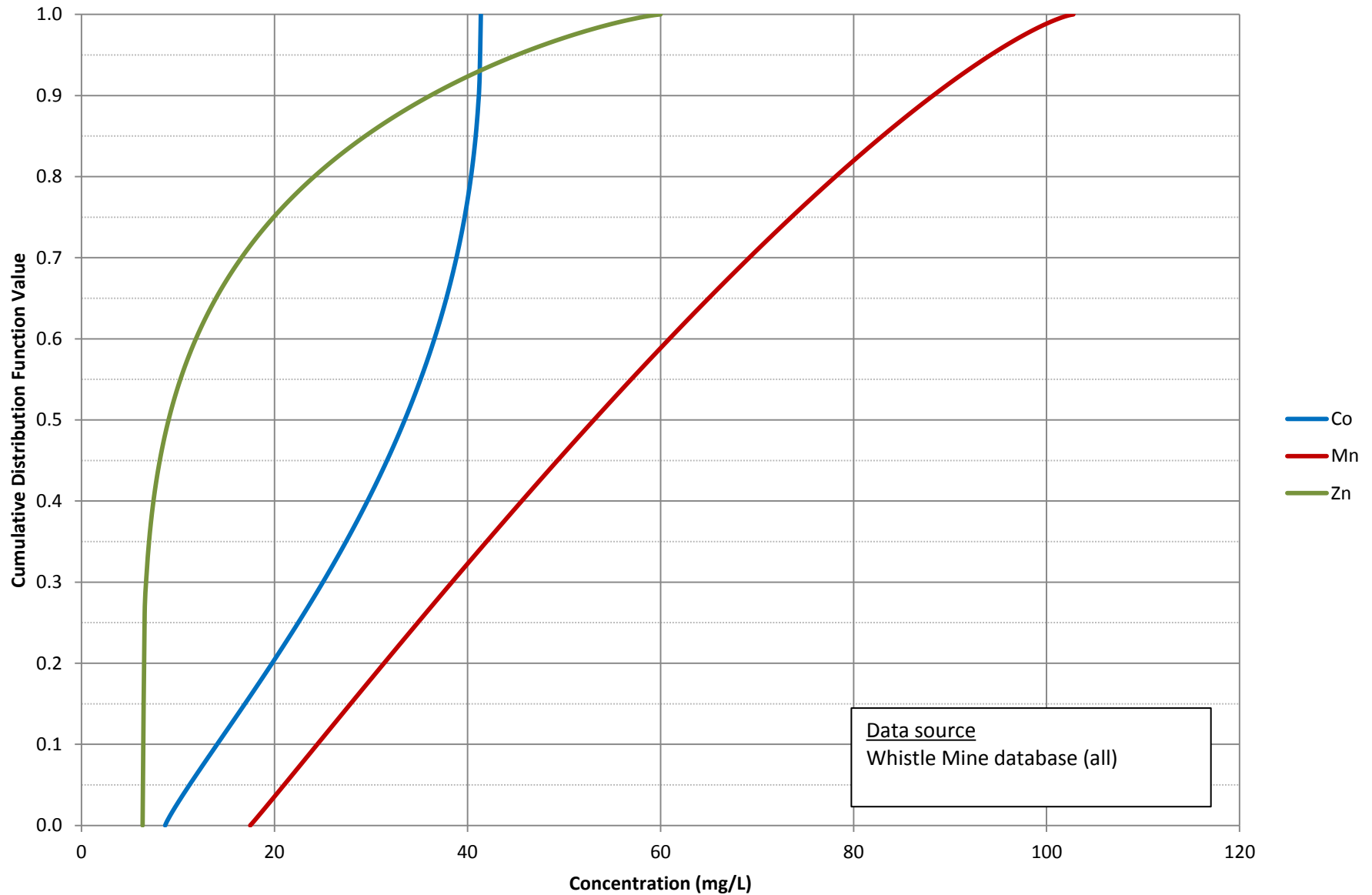

Large Figure 35

Distributions for Duluth Complex Category 2/3, 4 and Ore Concentration Caps (acidic) (d)

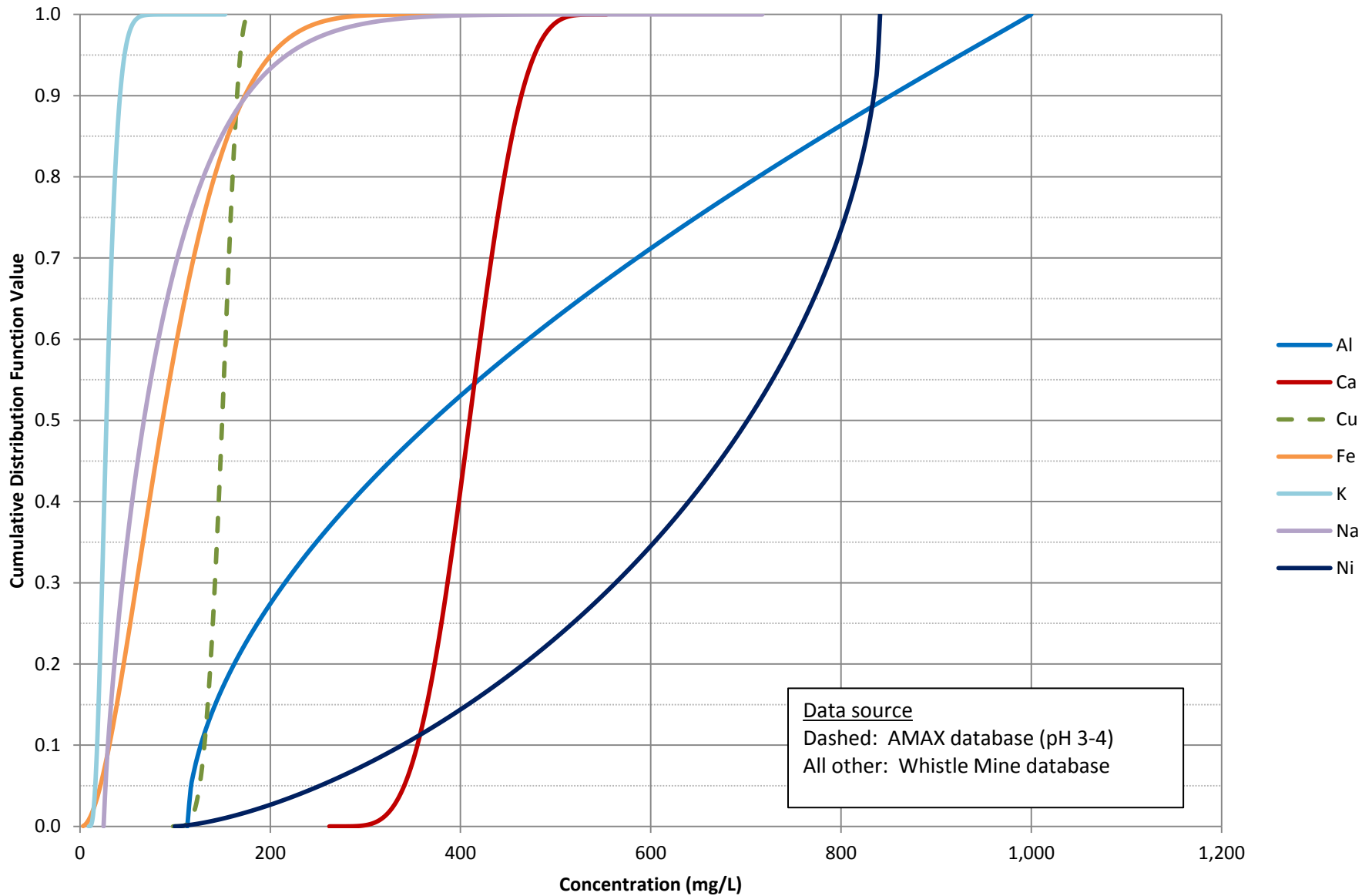



Large Figure 36

Distributions for Duluth Complex Category 2/3, 4 and Ore Concentration Caps (acidic) (e)

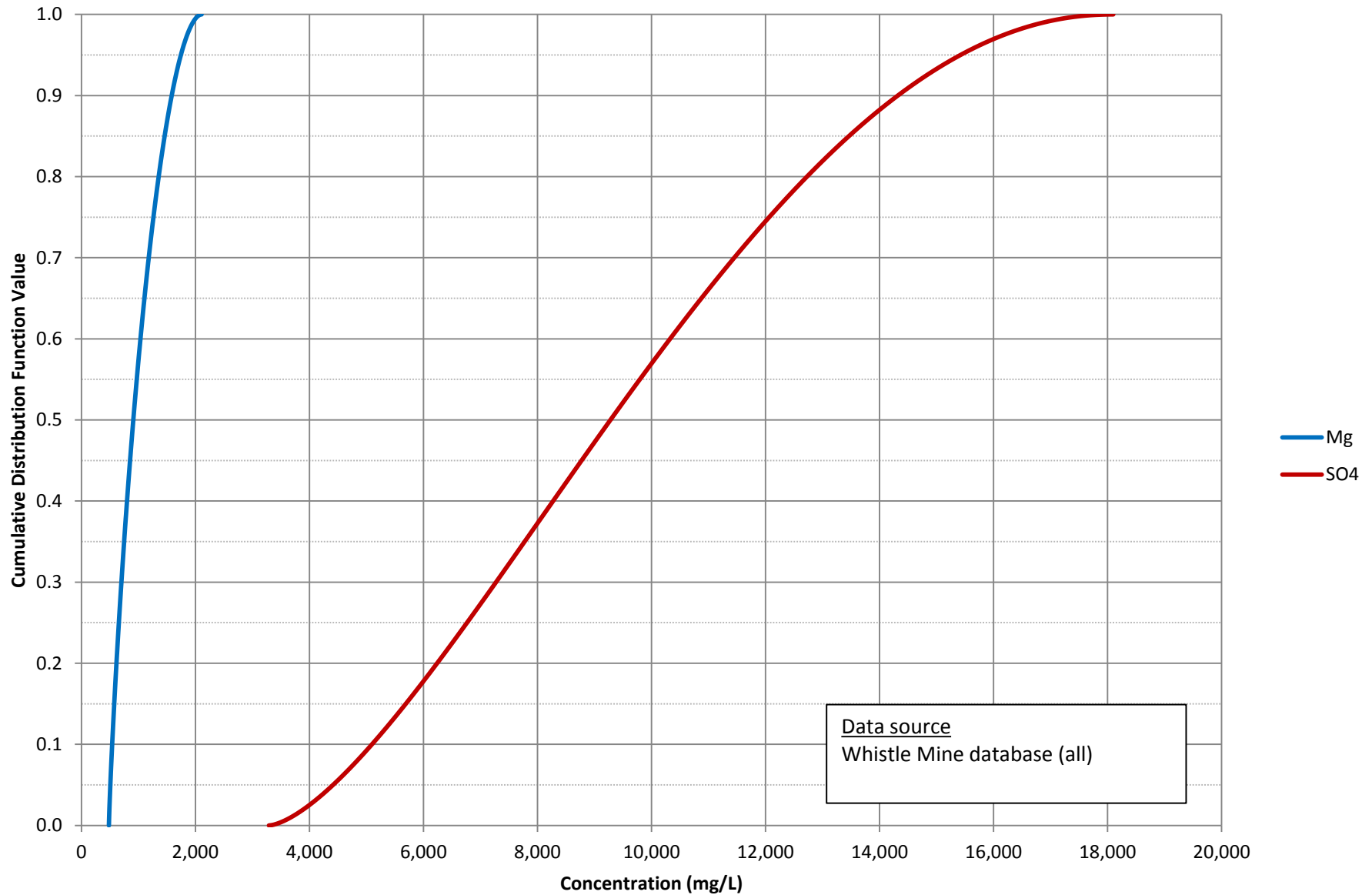

Large Figure 37

Distributions for Virginia Formation Category 4 Concentration Caps  
(a)

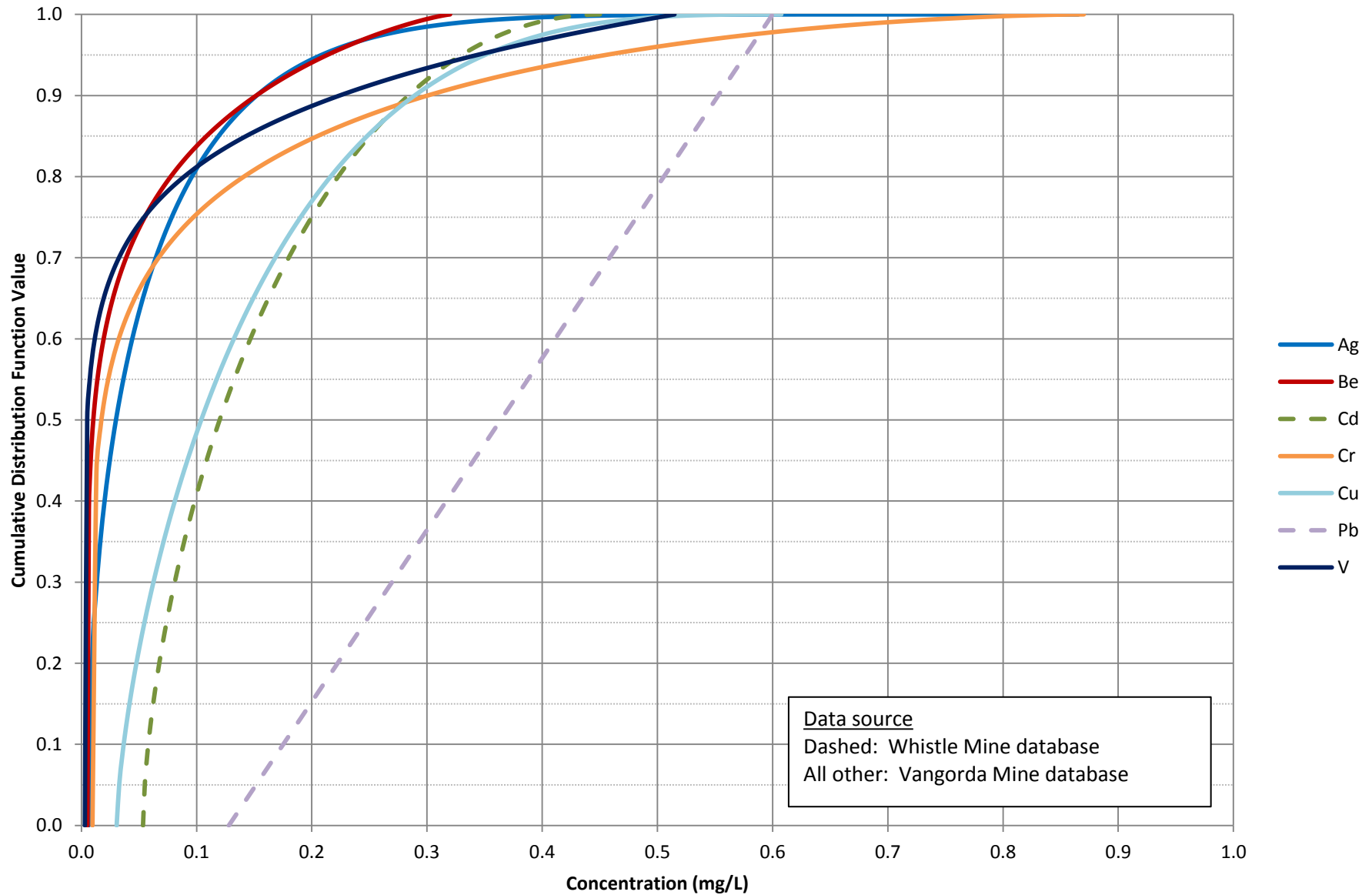

Large Figure 38

Distributions for Virginia Formation Category 4 Concentration Caps  
(b)

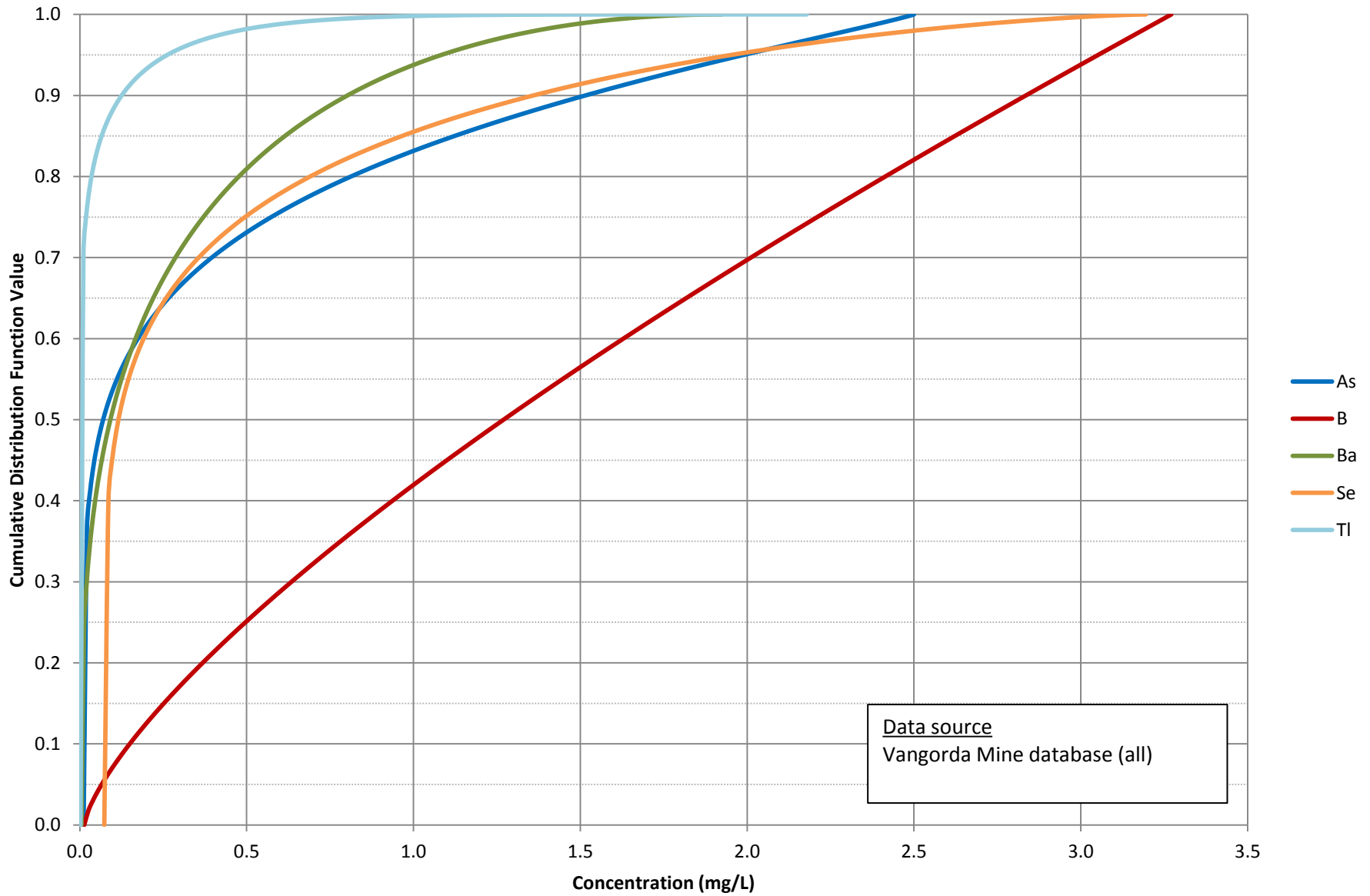

Data source  
Vangorda Mine database (all)

Large Figure 39

Distributions for Virginia Formation Category 4 Concentration Caps  
(c)

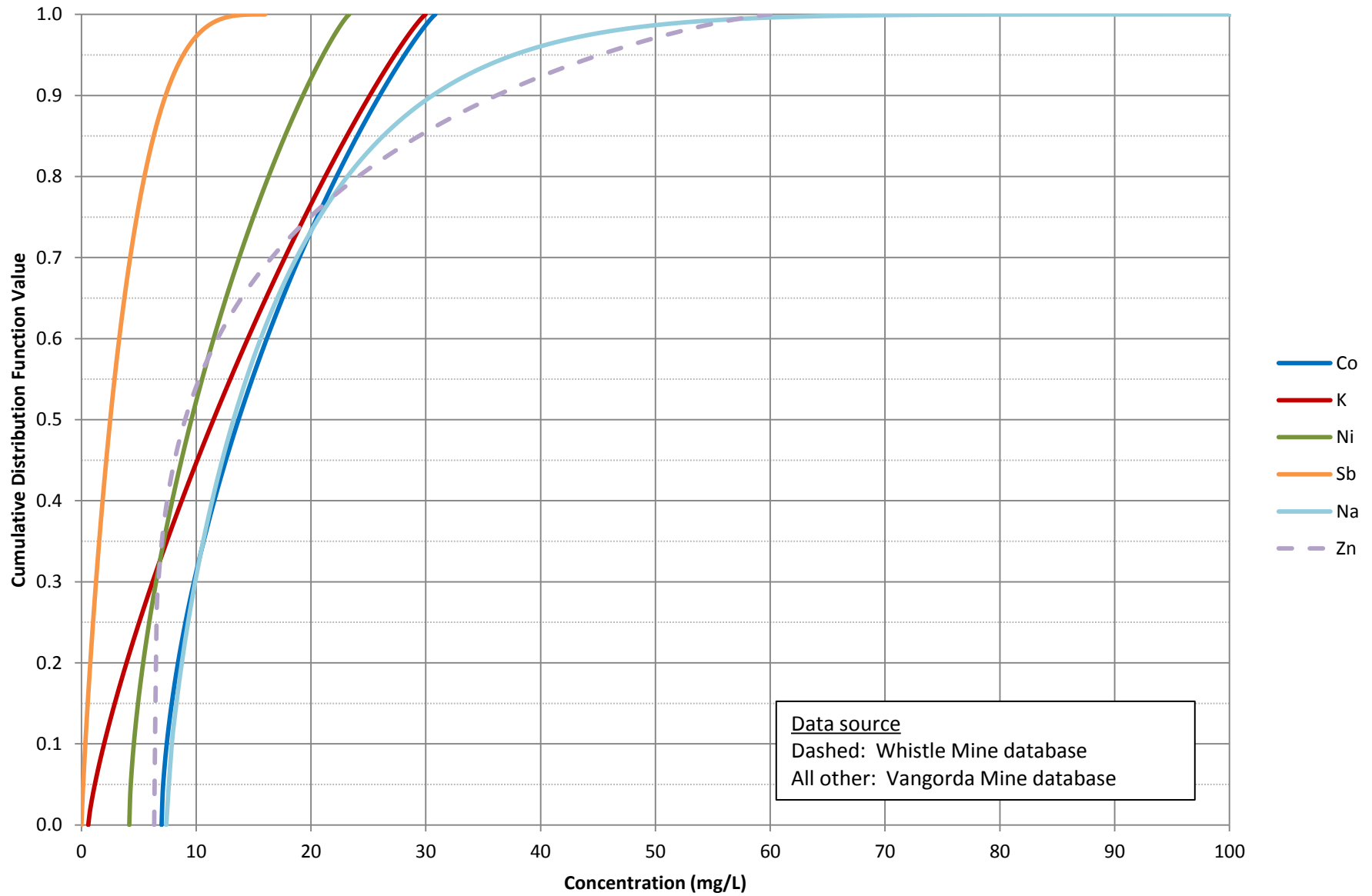

Large Figure 40

Distributions for Virginia Formation Category 4 Concentration Caps  
(d)

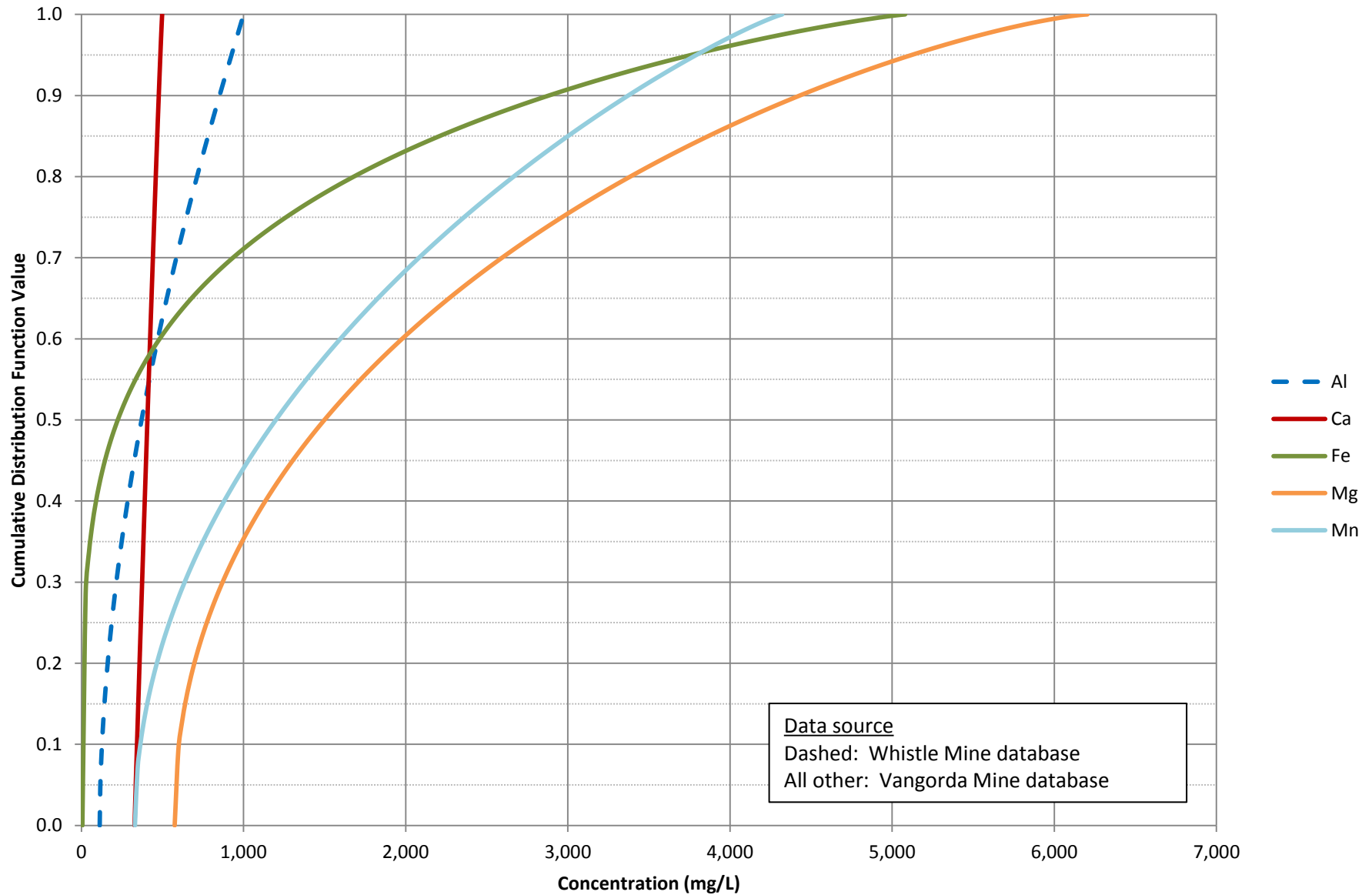

Large Figure 41

Distributions for Virginia Formation Category 4 Concentration Caps  
(e)

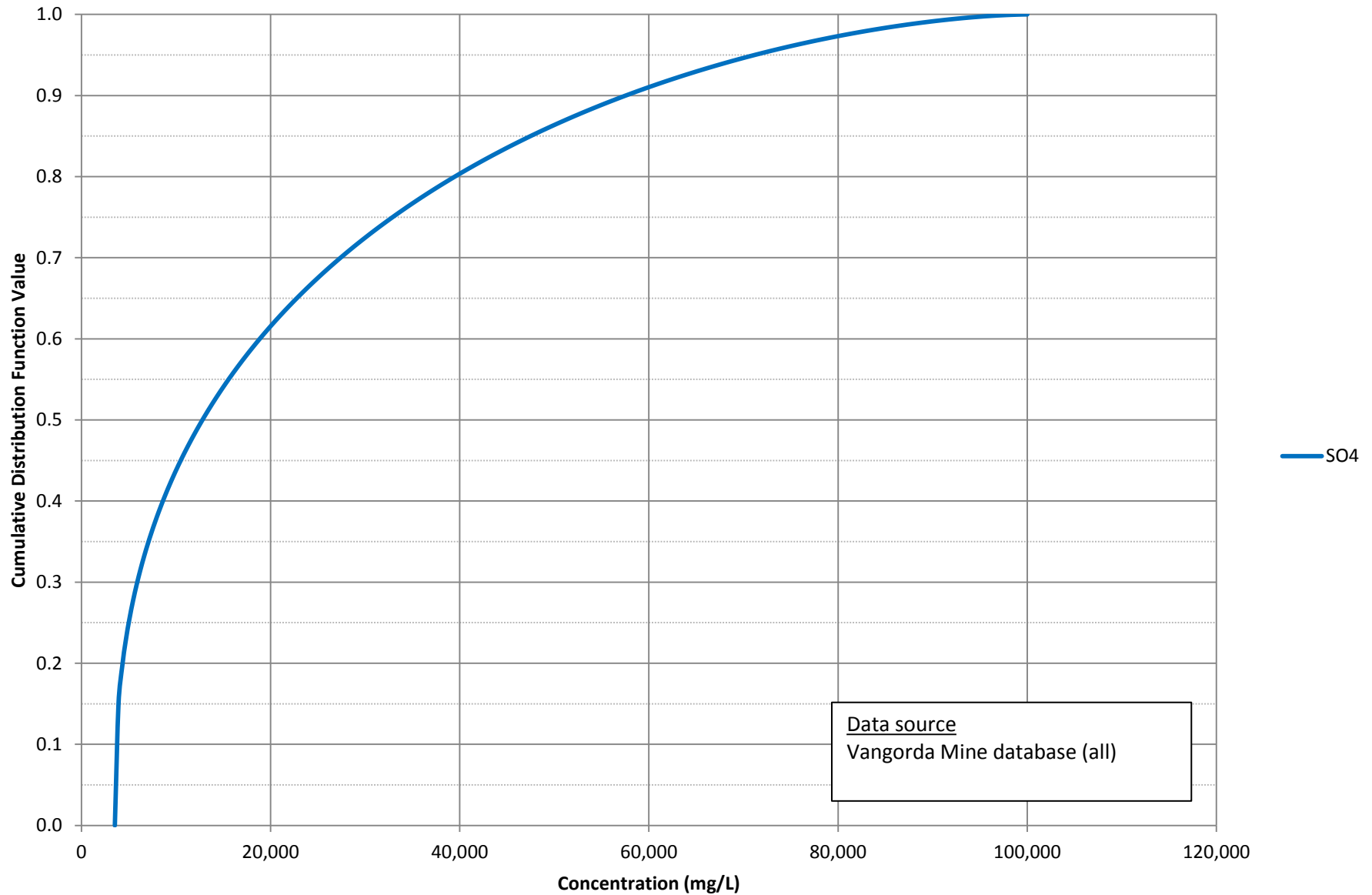

Large Figure 42

Distributions for Flotation Fine Tailings Release (a)

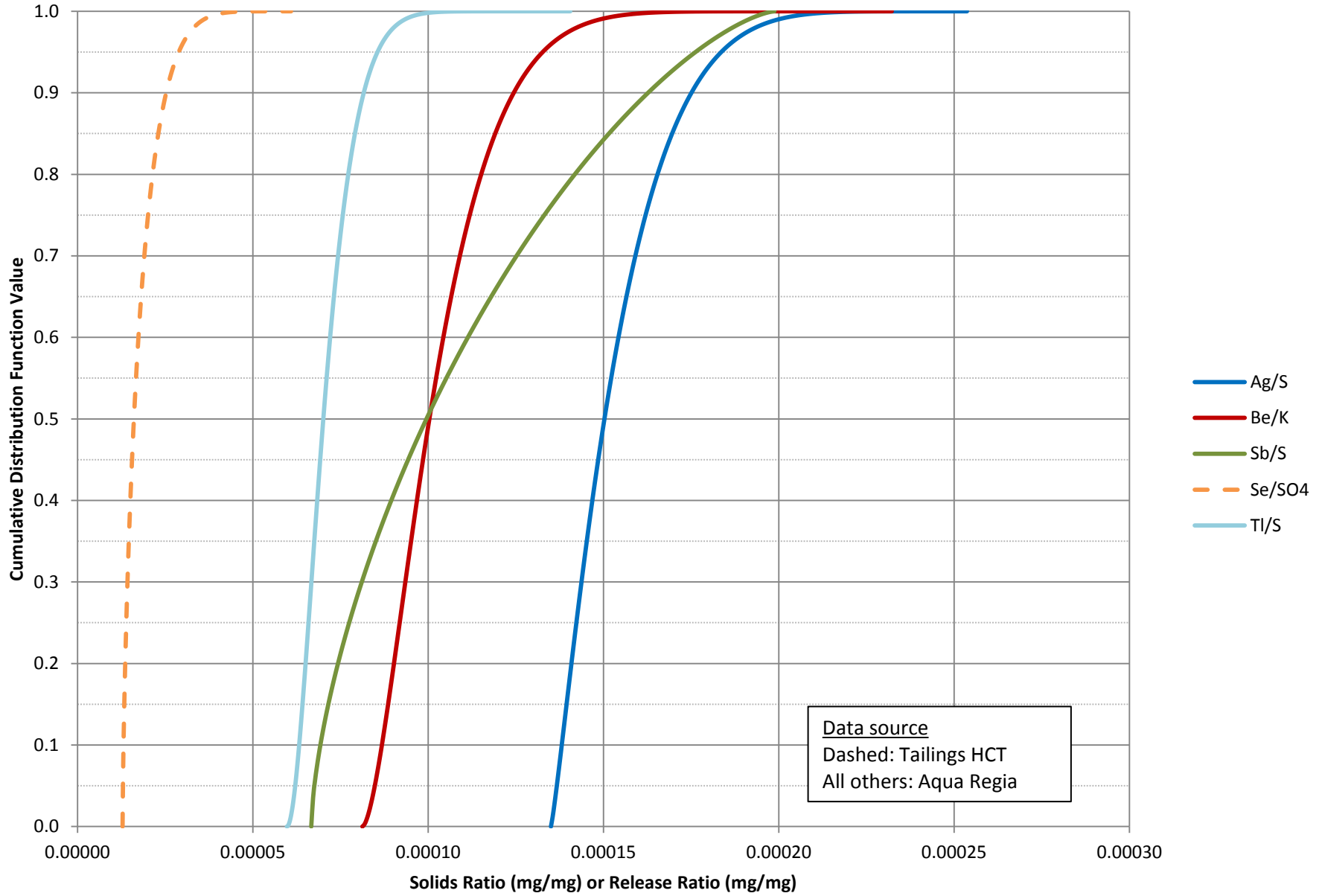

Large Figure 43

Distributions for Flotation Fine Tailings Release (b)

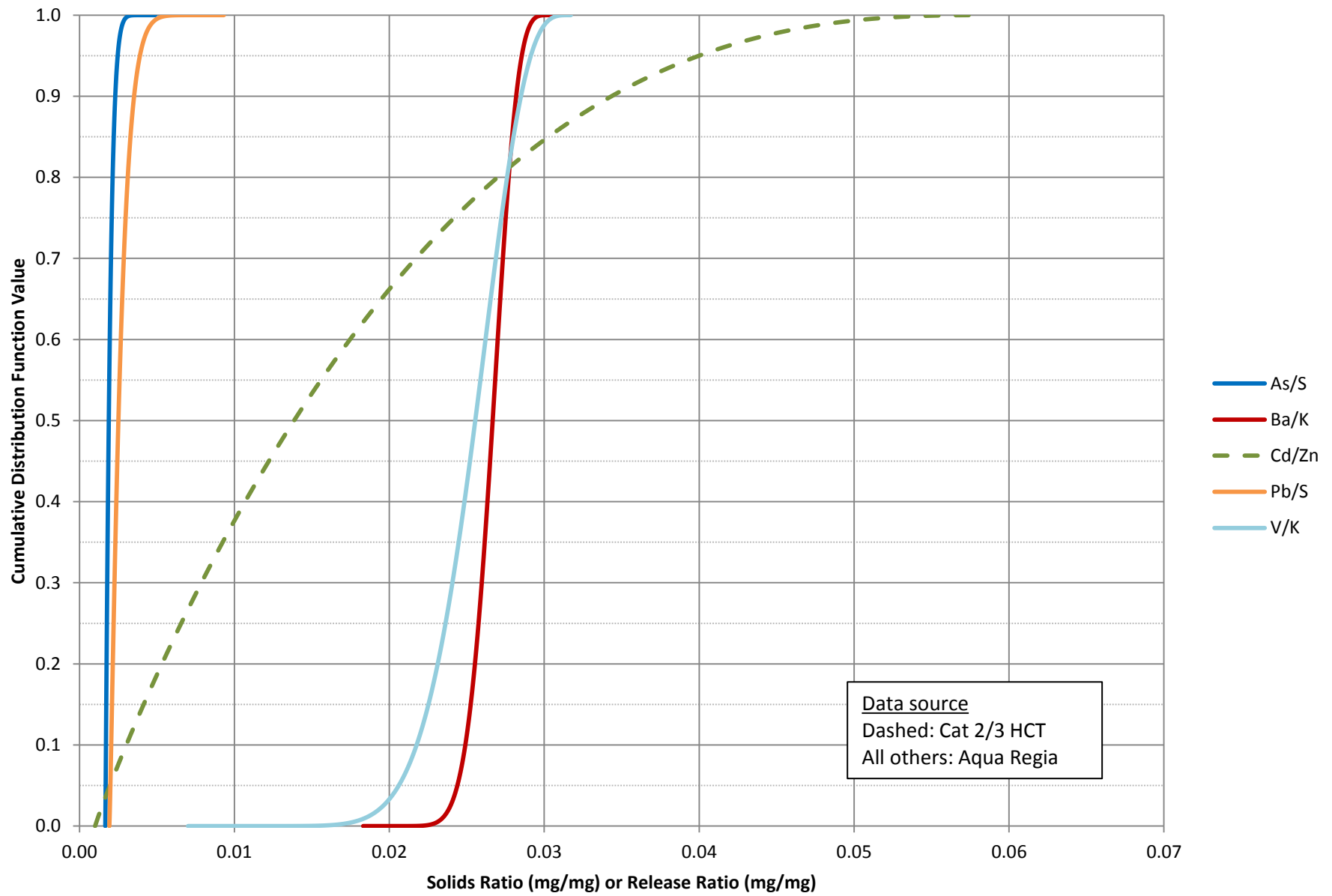



Large Figure 44

Distributions for Flotation Fine Tailings Release (c)

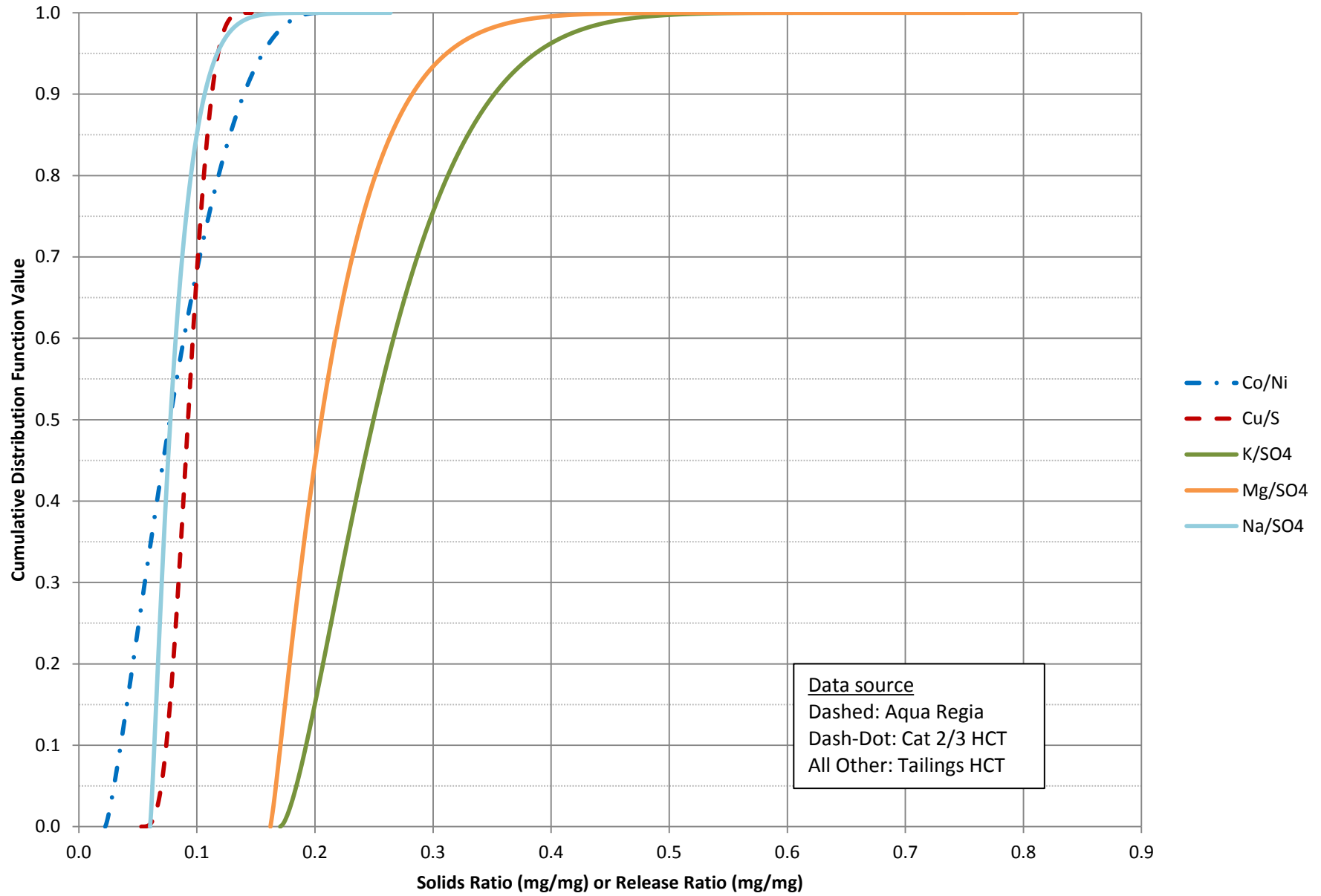

Large Figure 45

Distributions for Flotation Fine Tailings Release (d)

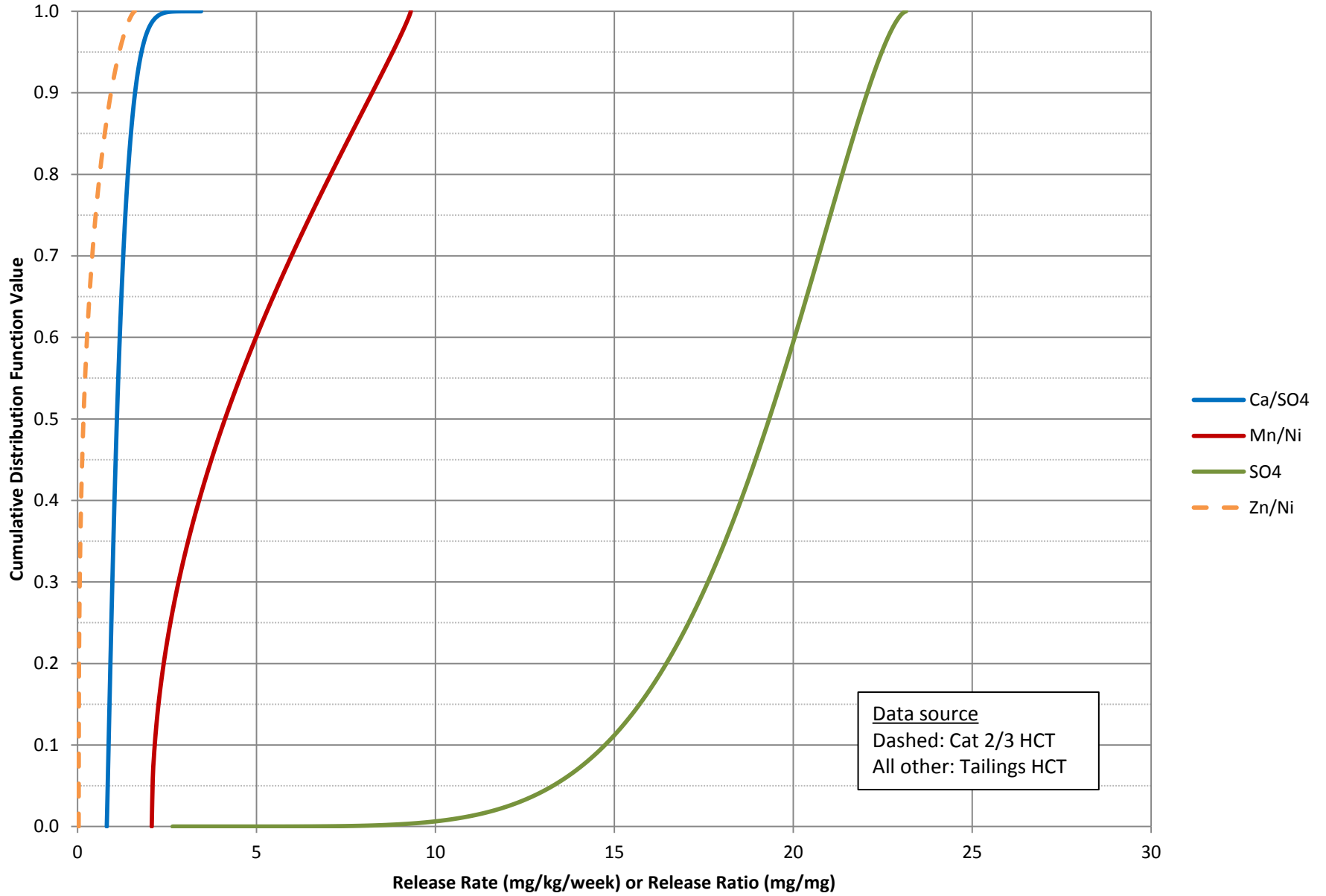

Large Figure 46

Distributions for Flotation Coarse Tailings Release (a)

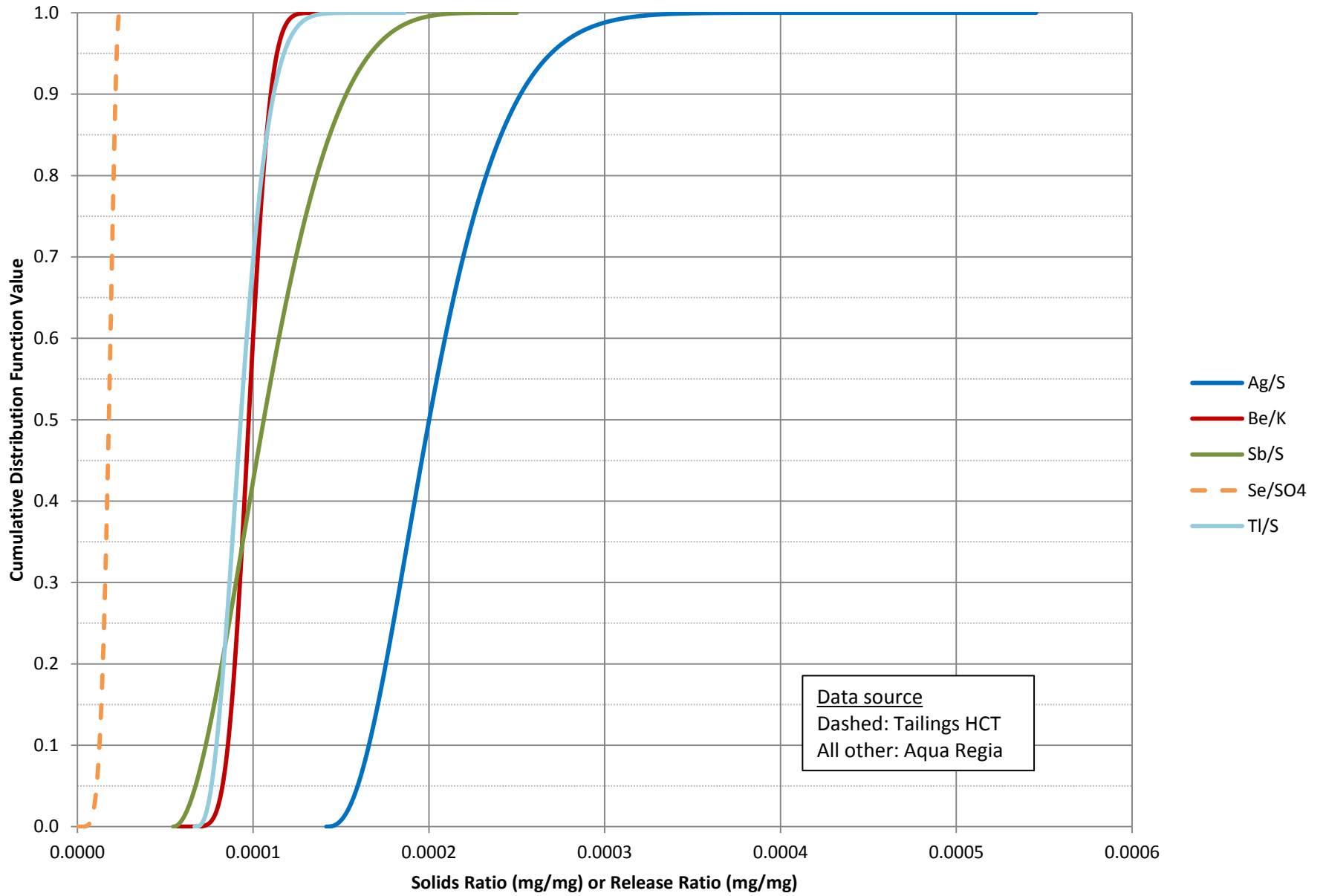

Large Figure 47

Distributions for Flotation Coarse Tailings Release (b)

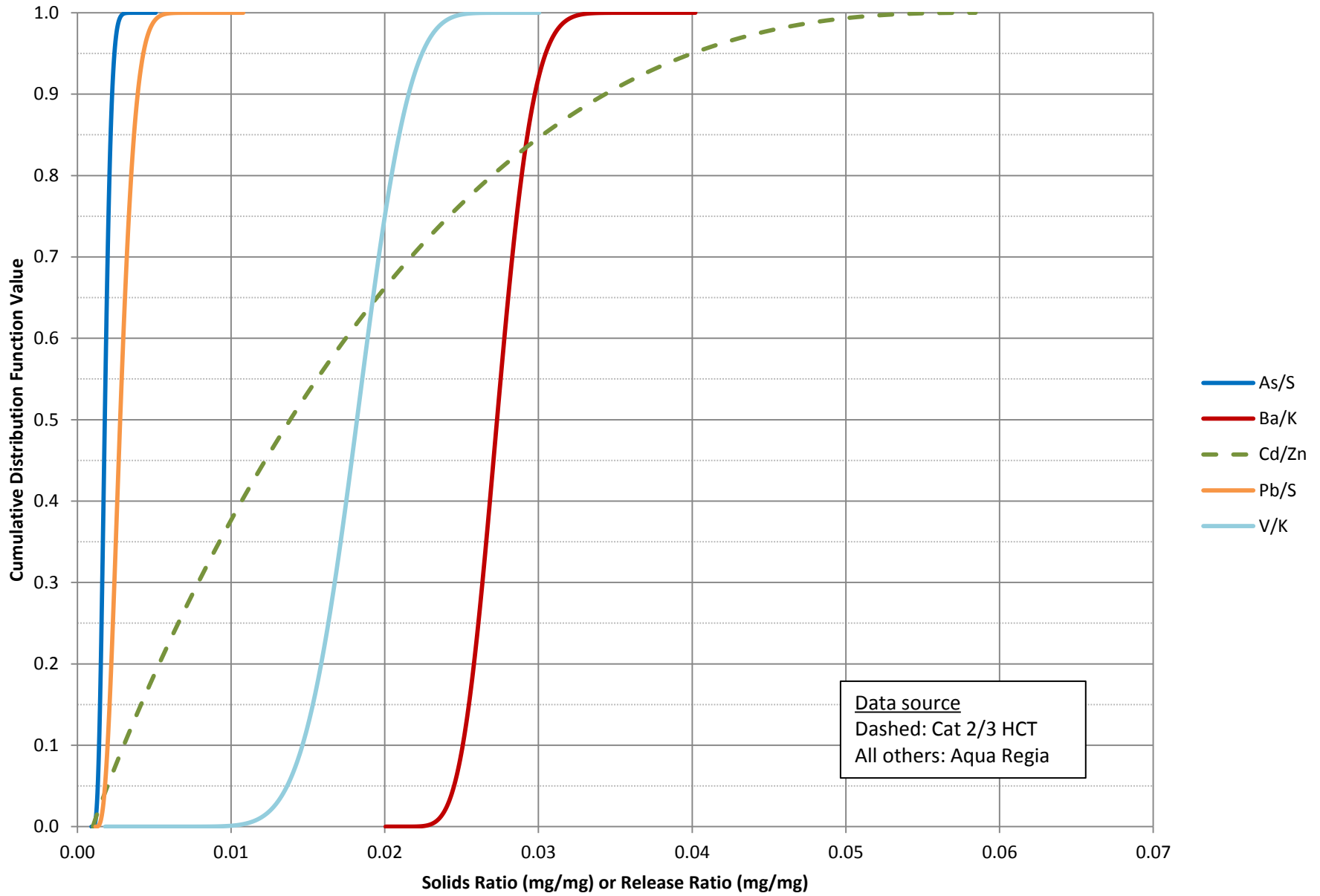

Large Figure 48

Distributions for Flotation Coarse Tailings Release (c)

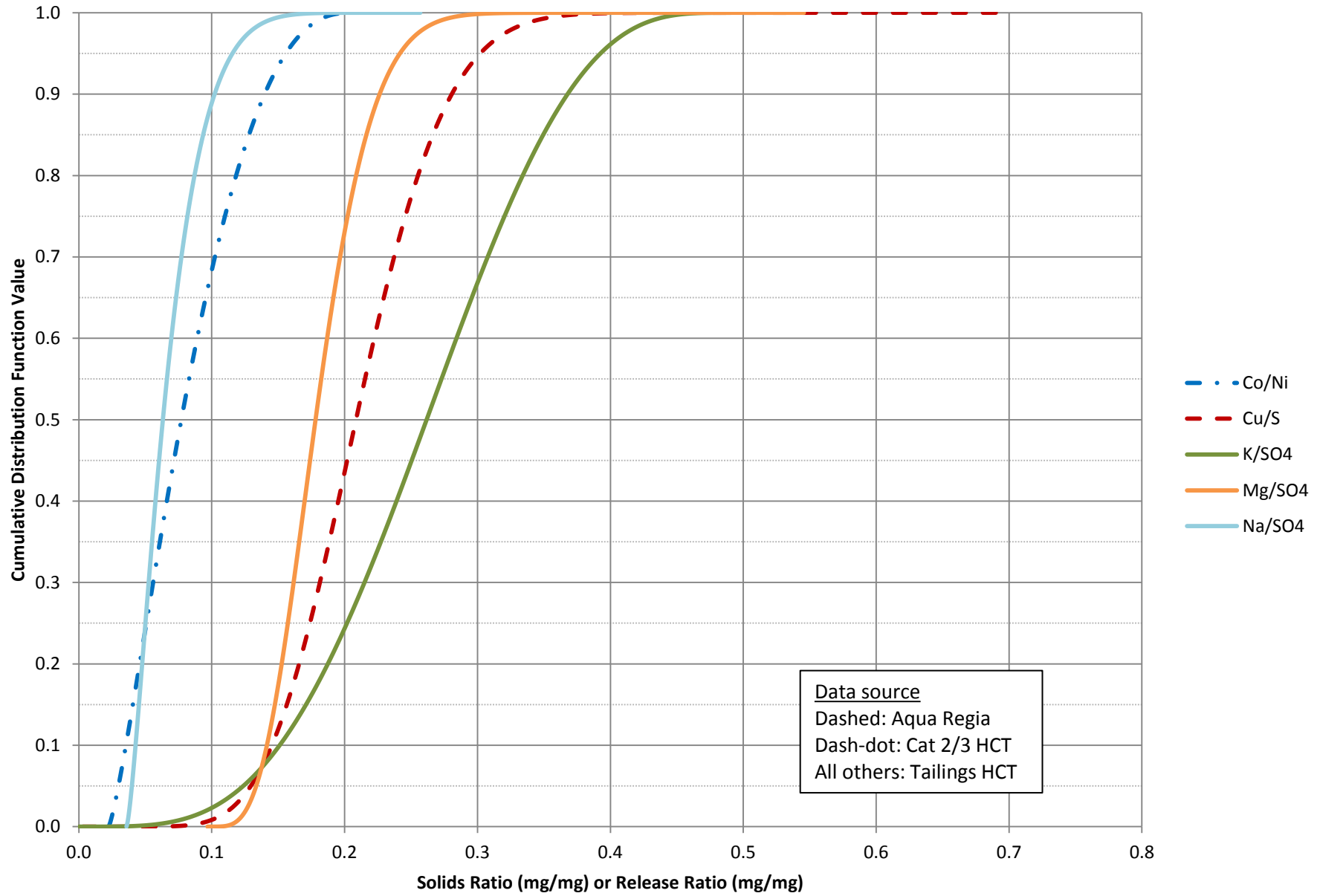

Large Figure 49

Distributions for Flotation Coarse Tailings Release (d)

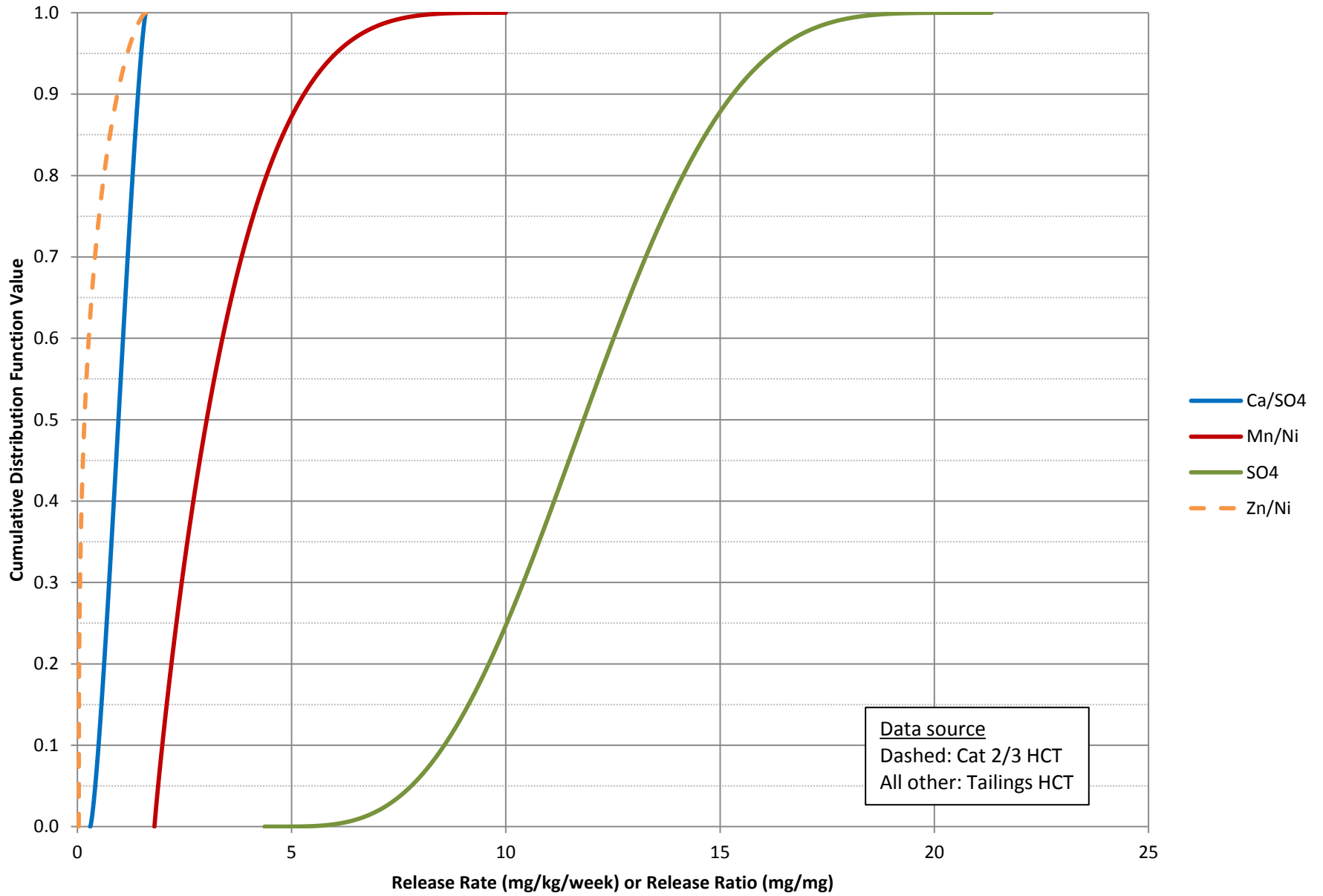

# Large Figure 50

# Distributions for LTVSMC Tailings Release (a)

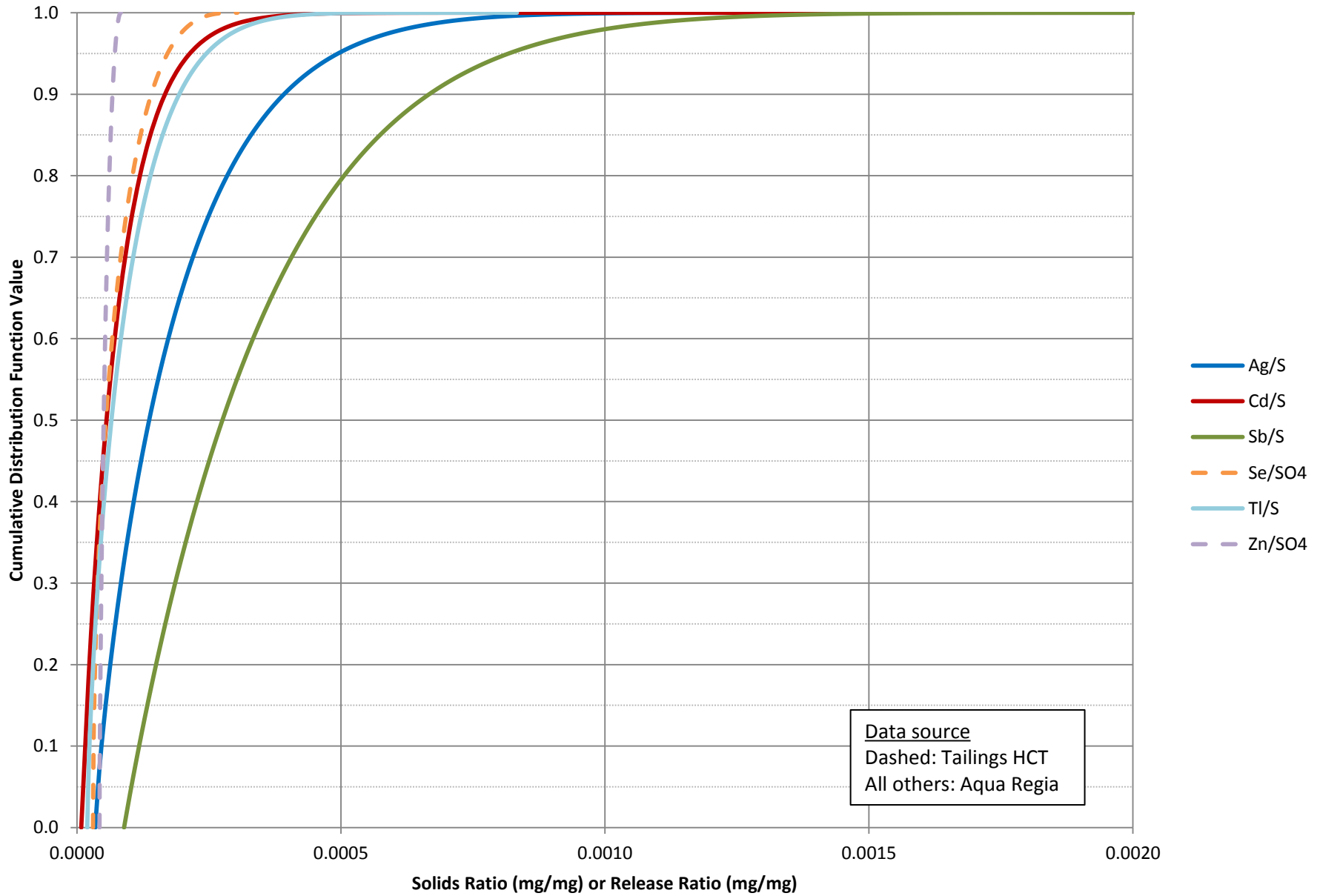

Large Figure 51

Distributions for LTVSMC Tailings Release (b)

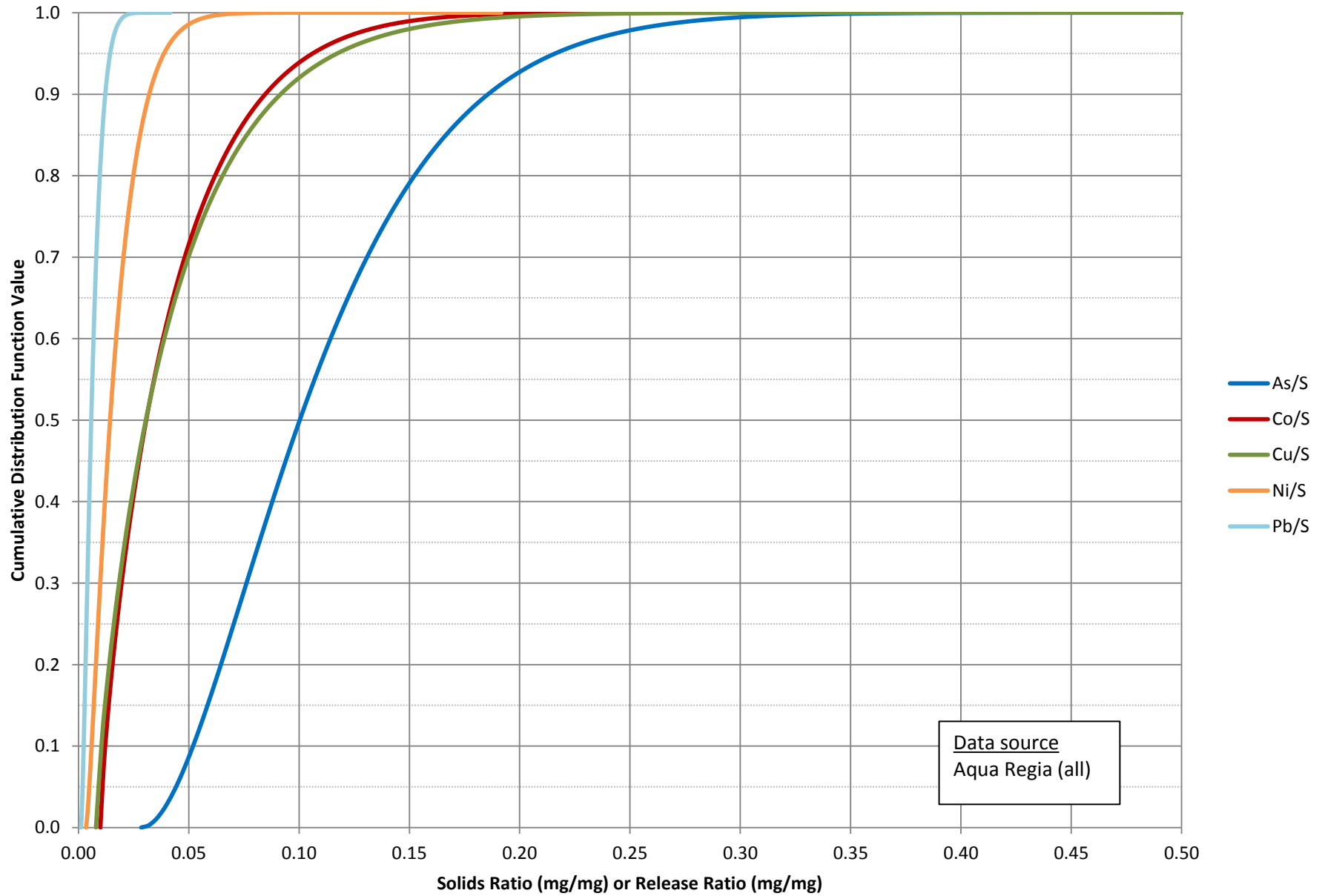



Large Figure 52

Distributions for LTVSMC Tailings Release (c)

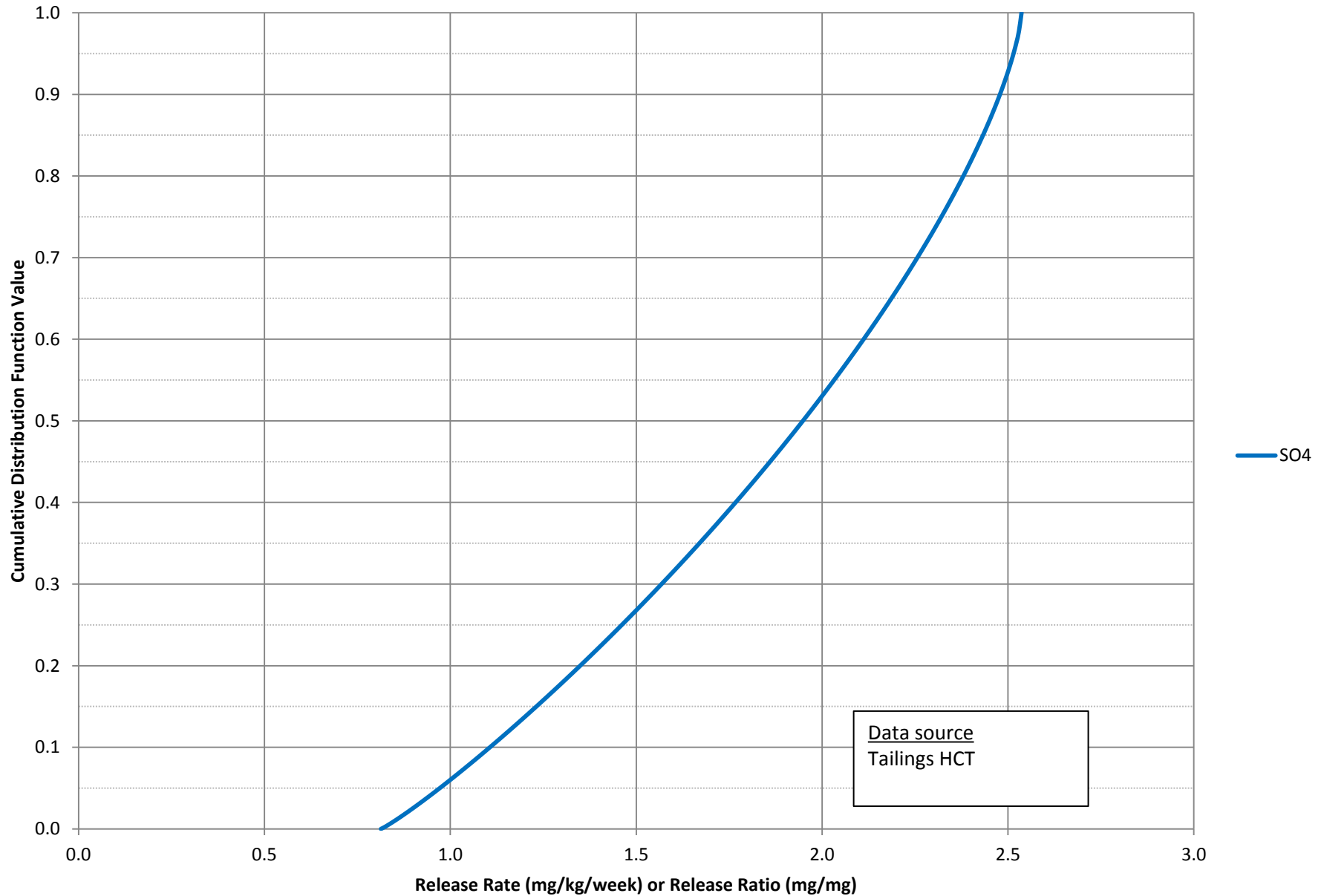

Large Figure 53

Distributions for LTVSMC Tailings Concentration-Controlled Release  
(a)

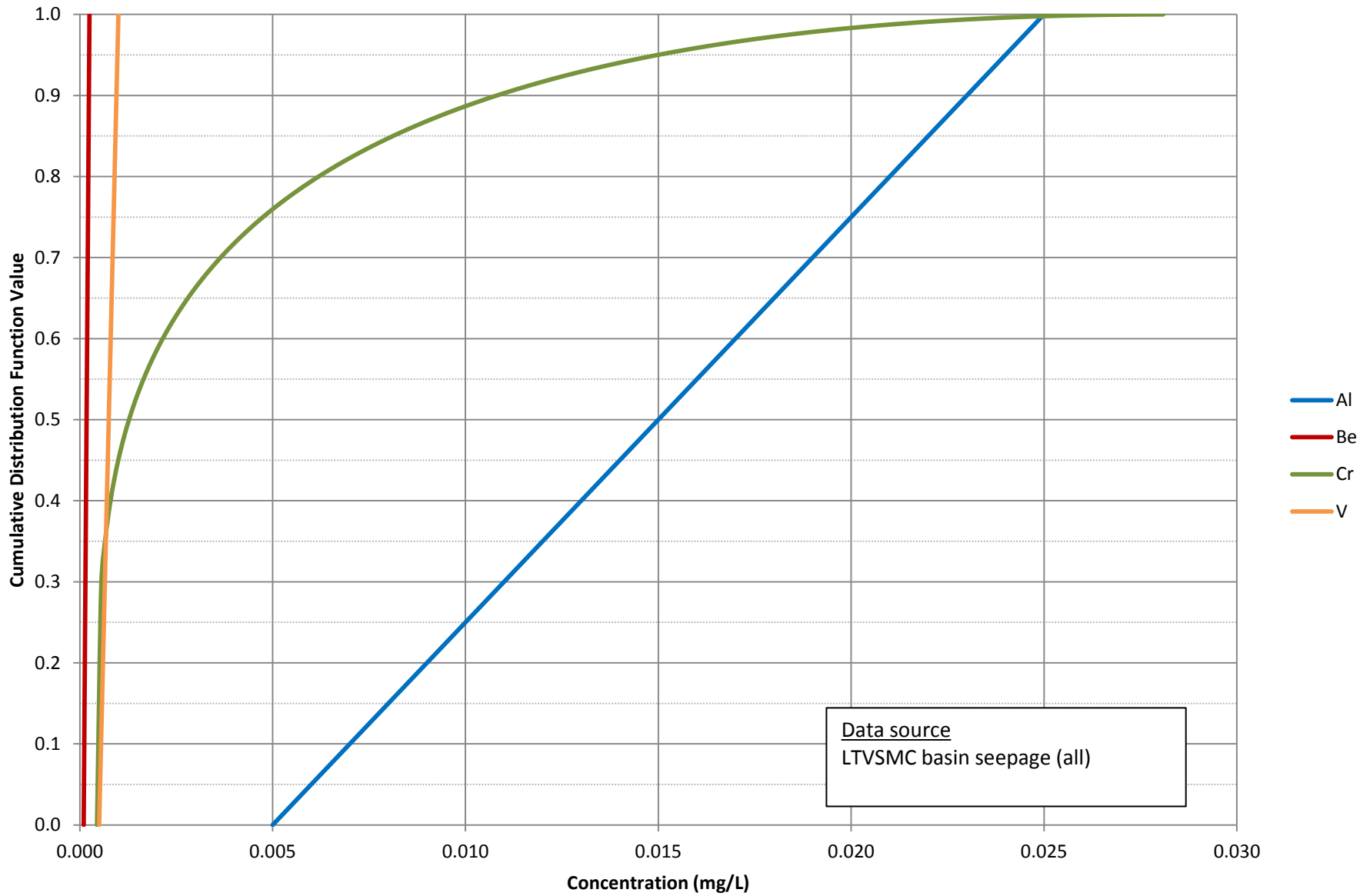

Large Figure 54

Distributions for LTVSMC Tailings Concentration-Controlled Release  
(b)

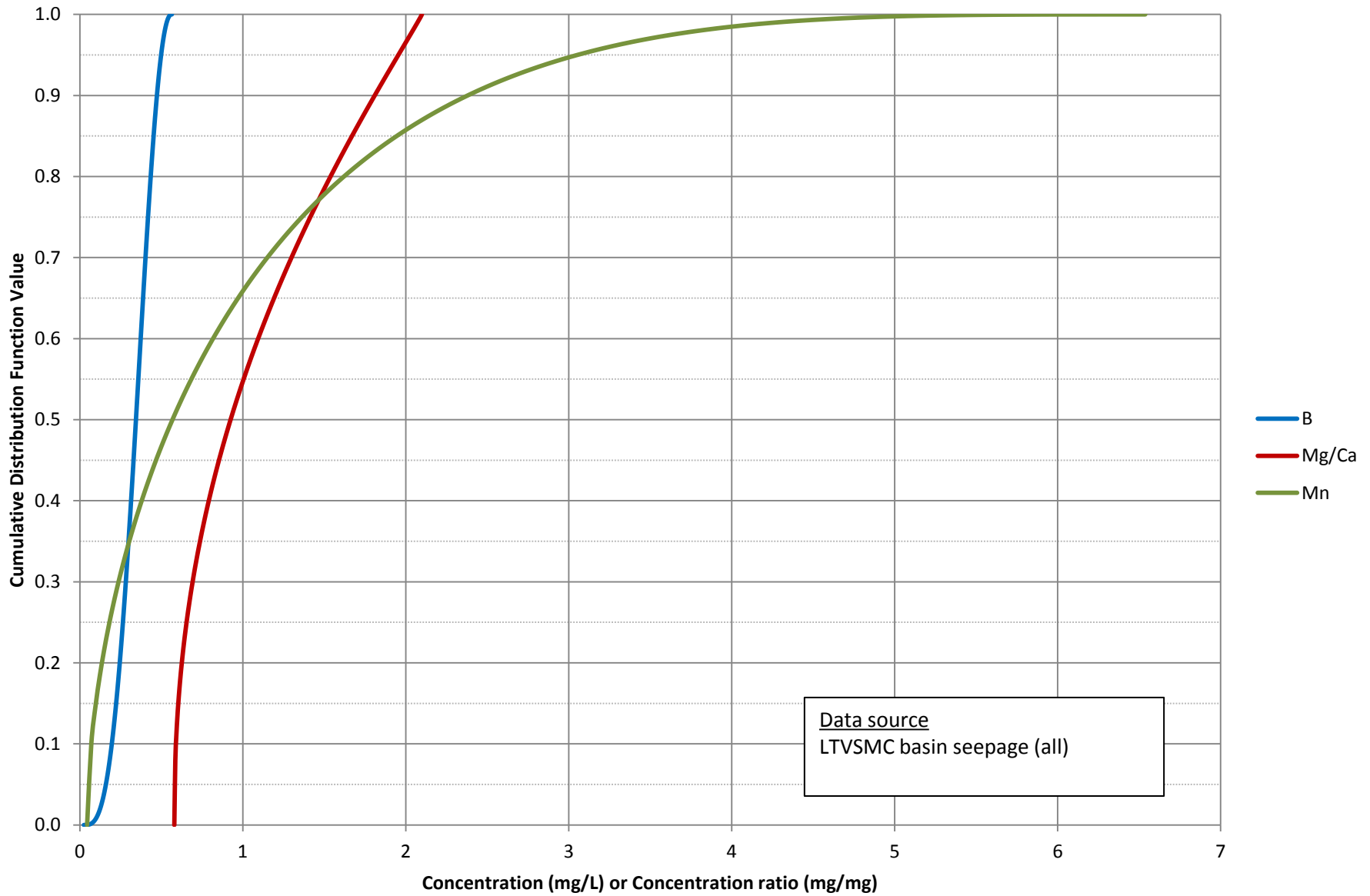

Large Figure 55

Distributions for LTVSMC Tailings Concentration-Controlled Release  
(c)

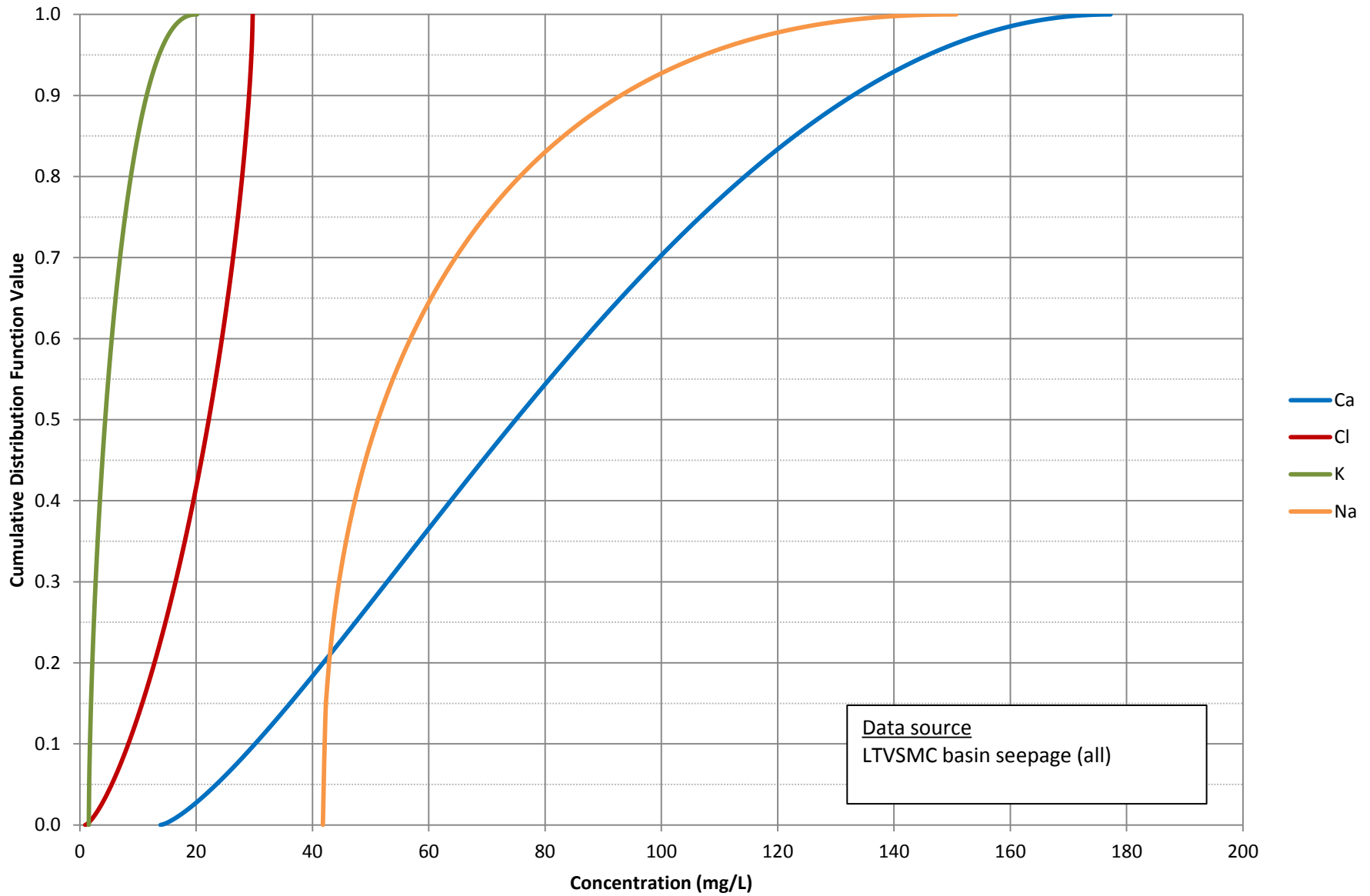

Large Figure 56

Distributions for LTVSMC Disturbed Flushing Load (a)

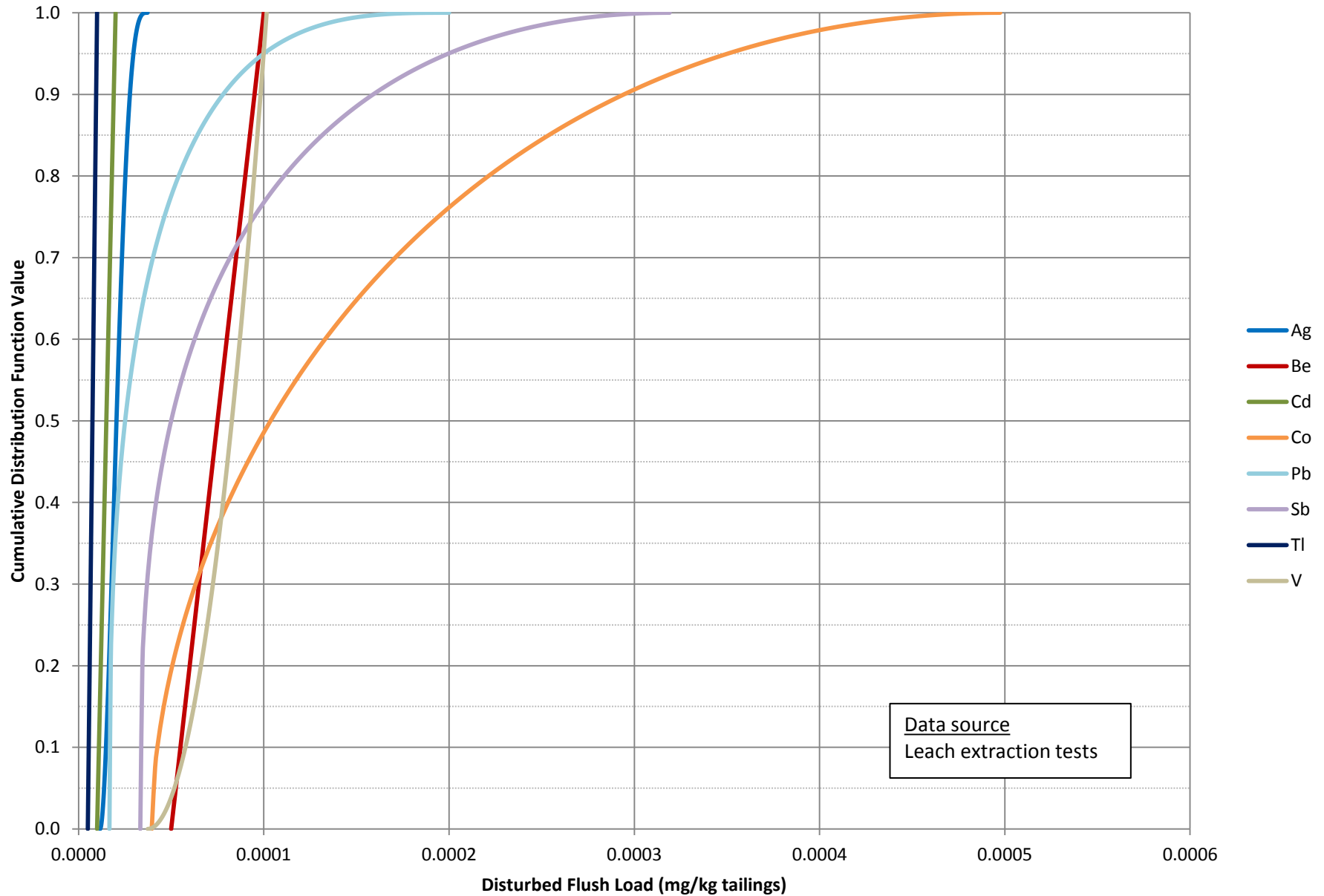

Large Figure 57

Distributions for LTVSMC Disturbed Flushing Load (b)

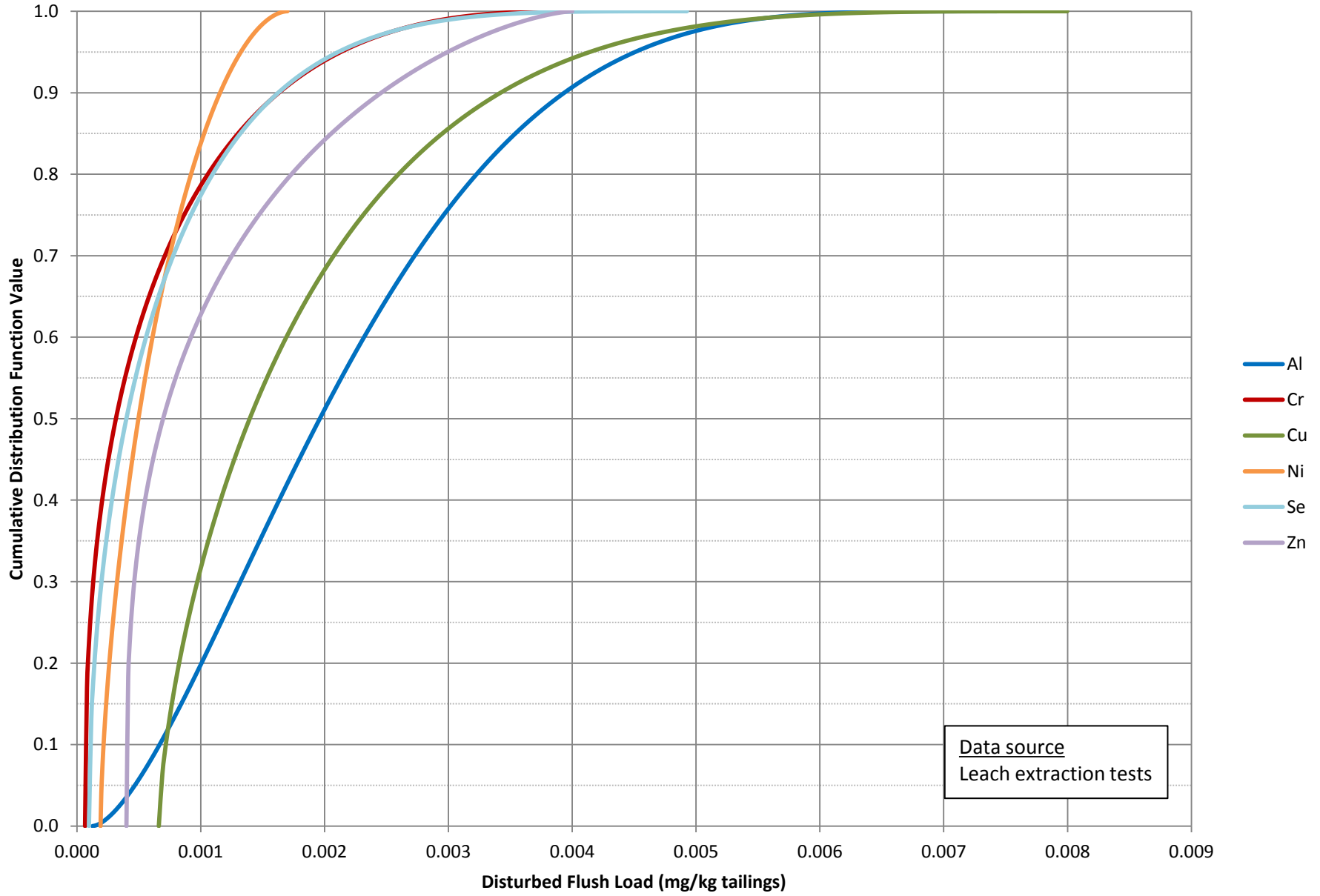

Data source  
Leach extraction tests

Large Figure 58

Distributions for LTVSMC Disturbed Flushing Load (c)

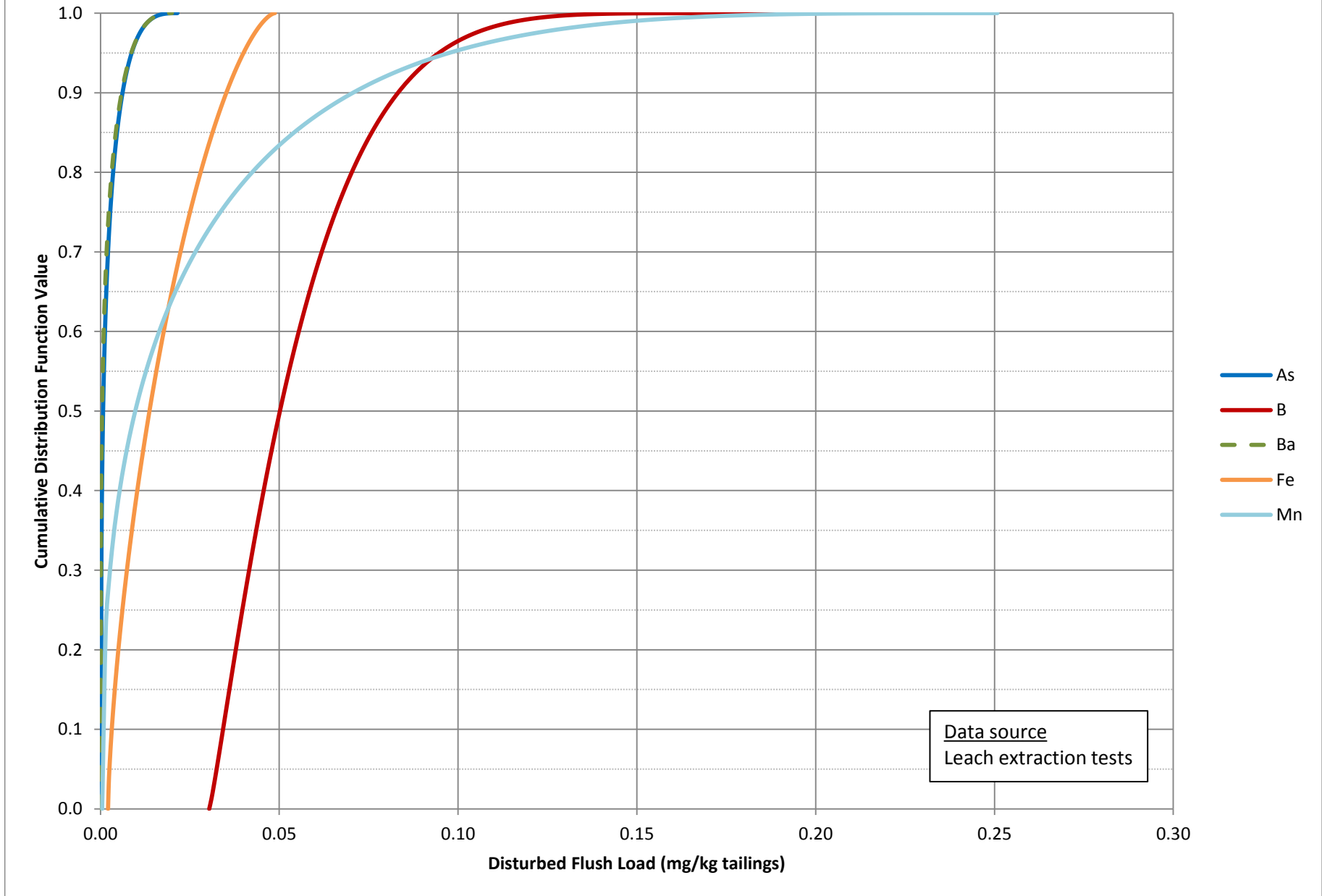

Large Figure 59

Distributions for LTVSMC Disturbed Flushing Load (d)

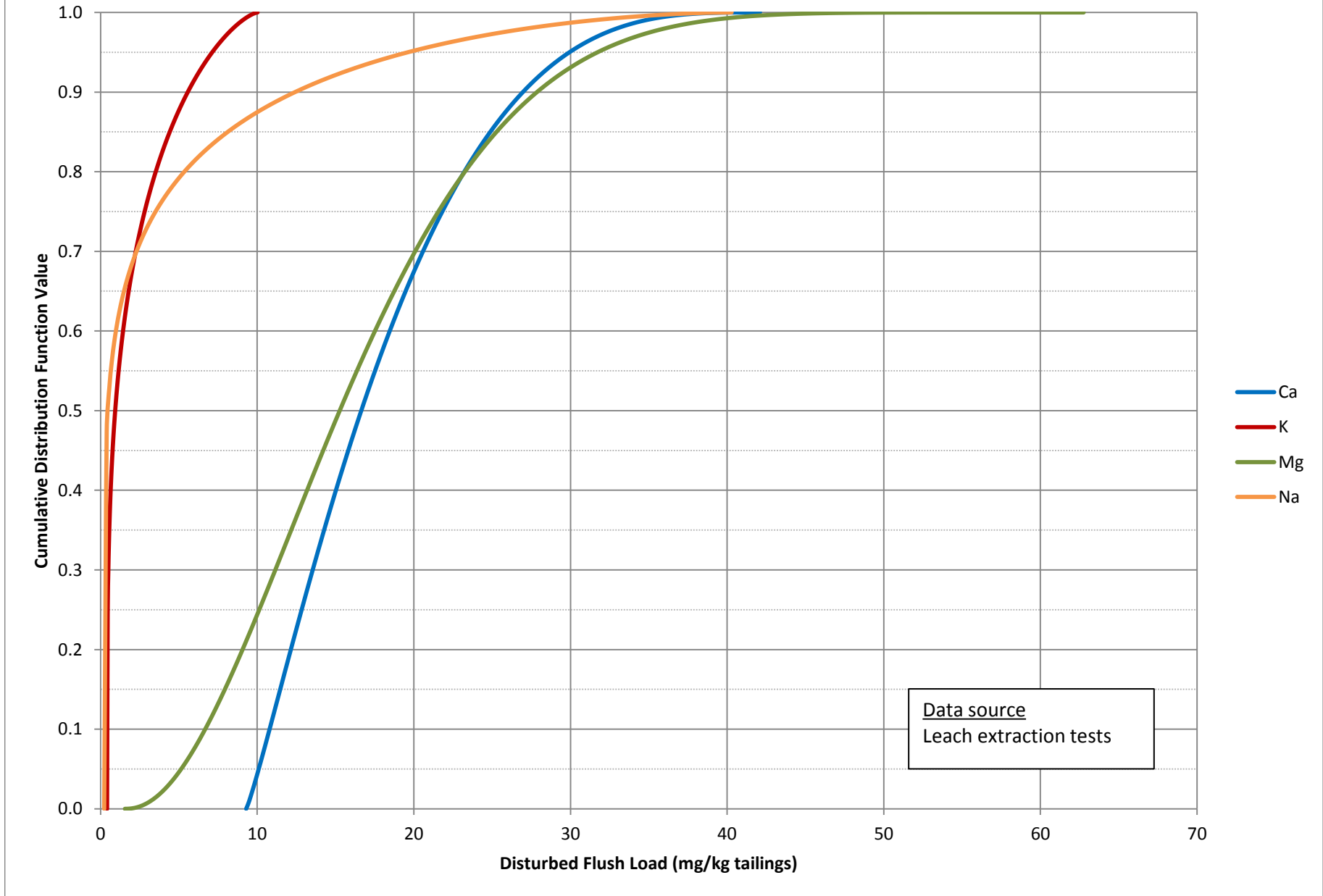



Large Figure 60

Distributions for LTVSMC Disturbed Flushing Load (e)

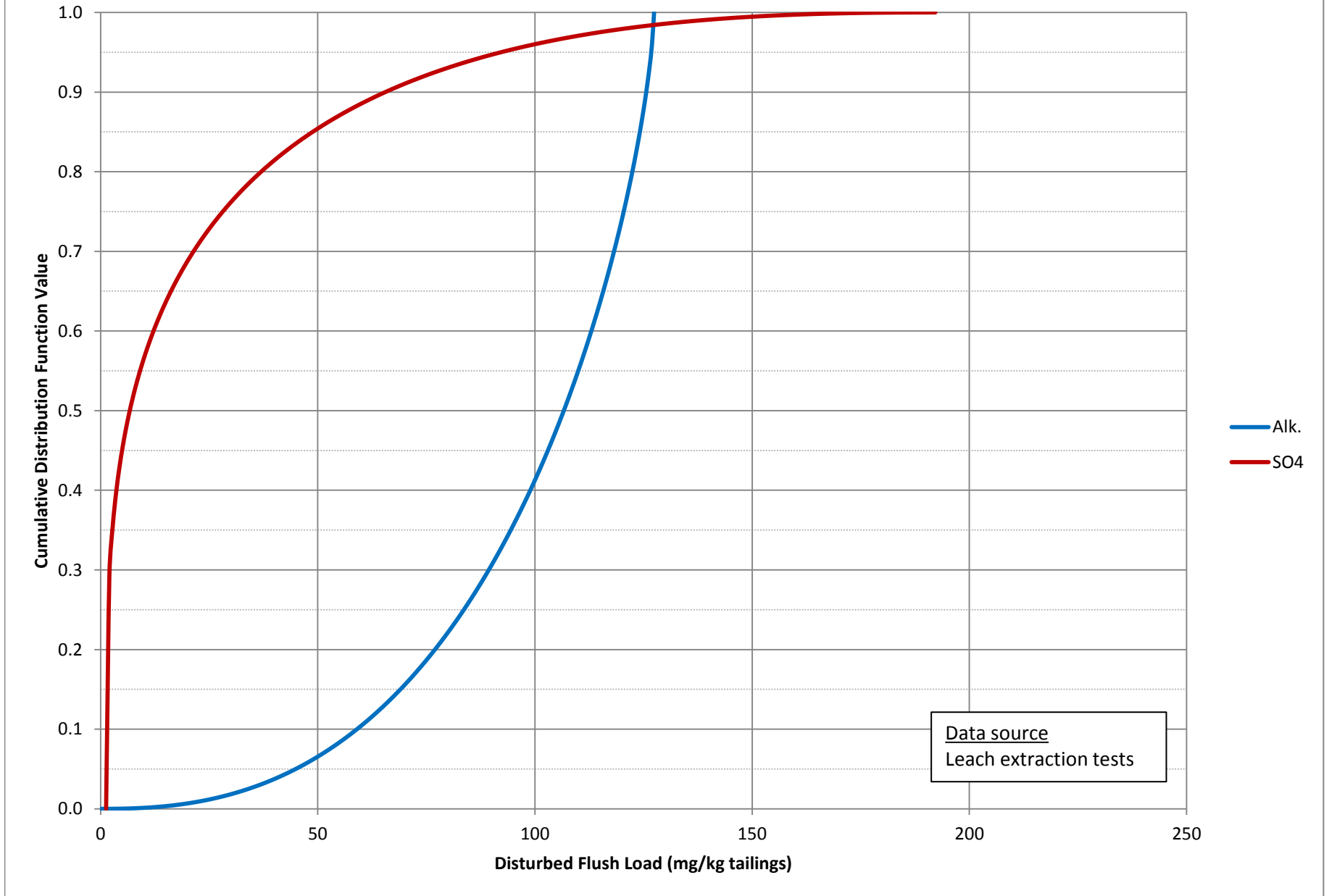

## Attachments

**Attachment A**

**Water Quality Modeling for Waste Rock and Pit Walls**

## Memo

---

<b>To:</b>	Jim Scott, PolyMet Peter Hinck, Barr	<b>Date:</b>	March 15, 2011
<b>cc:</b>		<b>From:</b>	Stephen Day
<b>Subject:</b>	Water Quality Modeling for Waste Rock and Pit Walls NorthMet Project – DRAFT 4	<b>Project #:</b>	1UP005.001

---

### 1 Background

Water quality modeling for waste rock involves consideration of the coupled processes of contaminant release by weathering of minerals and dissolution of the resulting weathering products by contact waters. The finite solubility of secondary minerals typically limits their dissolution so that leaching rates are lower than release rates on average.

The underlying input for these calculations has been rates indicated by humidity cells scaled to reflect site conditions. To this point, it has been assumed that rates of leaching indicated by humidity cells are largely free of solubility limitations due to the high liquid-to-solid ratios used in laboratory kinetic tests in order to obtain sufficient leachate for analysis. Data obtained from the experiments performed for the NorthMet Project demonstrate this is not the case. For example, nickel leaching can increase by orders of magnitude even as the oxidation and weathering of the sources of nickel decrease. Previous modeling did not fully separate contaminant release from solid phases<sup>1</sup> from solubility effects for the rates used in inputs to water quality calculations.

At meetings with MDNR representatives in St. Paul, MN on January 12<sup>th</sup> and 13<sup>th</sup>, 2011, SRK presented an approach to allow the processes of release and leaching to be clearly modeled separately. This memorandum provides details of the proposed approach.

### 2 Calculation of Solid Phase Release Rates

#### 2.1 Conceptualization

Potential contaminants are released from their primary mineralogical hosts by weathering or dissolution processes. For example:

- Metals contained in sulfide minerals are released by oxidation to form metal sulfates and hydroxides.
- Metals contained in silicate minerals are released by carbonic acid weathering to form metal silicates and hydroxides.
- Metals contained in silicates can also be released when they are dissolved by sulfuric acid produced by sulfide oxidation.

---

<sup>1</sup> In this document, “Release Rates” refers to the conversion of potential contaminants in primary solid phases into solid secondary weathering products which are then available for leaching. “Leaching Rates” refers to the transfer of potential contaminants from the secondary weathering products to the aqueous phase.

In each of the above examples, major mineral components are released along with the trace levels of potential contaminants. In the case of pyrrhotite (iron sulfide), iron and sulfur are released along with elements such as cobalt and nickel. It is reasonable to assume that the iron, cobalt and nickel will be released from the mineral in proportion to the metal to sulfur ratios in pyrrhotite. Since sulfate is readily soluble, pyrrhotite oxidation can be quantified by measuring sulfate release ( $R_S$ ); however, the metals may form less soluble oxides and hydroxides particularly under non-acidic conditions. The rate of release of metals ( $R_M$ ) to secondary minerals in response to oxidation is therefore more appropriately represented by:

$$R_M = R_S \cdot \frac{[M]_{\text{solid}}}{[S]_{\text{solid}}}$$

where  $[M]_{\text{solid}}$  and  $[S]_{\text{solid}}$  are the metal and sulfur concentration in the solid pyrrhotite, respectively. Similarly, dissolution of olivine can be expected to release magnesium, silica and trace elements. Magnesium is expected to be readily soluble but trace elements may form less soluble secondary minerals. Release of metals from olivine can therefore be represented by:

$$R_{\text{metal}} = R_{\text{Mg}} \cdot \frac{[M]_{\text{solid}}}{[\text{Mg}]_{\text{solid}}}$$

To implement these concepts for modeling, the following components are needed:

- Determination of major mineral hosts for potential contaminants;
- Within mineral hosts, identification of readily soluble ions that allow oxidation and weathering processes to be quantified; and
- Quantification of solid ratios.

Each aspect is described in the following sections.

## 2.2 Mineral Hosts for Potential Contaminants

Mineral hosts for potential contaminants were evaluated using five sources:

- The “Goldschmidt Classification” of elements broadly groups elements into lithophile (elements with a strong affinity for oxygen and therefore associated with oxides and silicates in the earth’s crust), siderophile (elements with affinity for metallic iron), chalcophile (elements with low affinity for oxygen and tending to bond with sulfur to form sulfides) and atmophile (elements found mainly as gases).
- Literature on mineral partition coefficients ( $K_d$ ) (EarthRef.org 2009<sup>2</sup>).
- Evaluation of relationships between elements determined by near whole rock analysis. The analysis used was ICP data following aqua regia digestion. Element relationships are provided in Attachment 1.
- Evaluation of mineral microprobe analysis of individual mineral grains. This was used principally for understanding the distribution of nickel in pyrrhotite. These data were provided previously by SRK (2007).
- Evaluation of release rate correlations for humidity cell leachates. Explanation of the use of humidity cell data is provided in Section 2.5 below. Specific relationships used to understand release of cadmium, cobalt and manganese are shown in Figure 1.

Results of the various assessments are shown as the mineral sources in Table 1.

<sup>2</sup> EarthRef.org. 2009. Geochemical Earth Reference Model. <http://earthref.org/GERM/>.

The dominant mineral hosts are the major sulfide minerals (pyrrhotite and chalcopyrite) for the chalcophile and siderophile elements, olivine for the siderophile elements, and biotite for some lithophile elements. The latter was a result of the finding that concentrations of barium, beryllium and vanadium were correlated with potassium concentrations.

No mineral hosts were specifically identified for boron, chromium, molybdenum and thallium. Chromium is likely hosted by oxides such as magnetite with low solubility. Molybdenum and thallium are probably associated with sulfides.

While plagioclase is a major rock component which is important in buffering acidity, it does not appear to be an important source of trace elements.

**Table 1: Proposed Approach to Derivation of Inputs to Release Rates. Refer to Sections 2.3 to 2.6 for explanation of methods and sources.**

	Goldschmidt Classification	Duluth Complex Category 1				Duluth Complex Category 2/3 and 4				Virginia Formation Category 4			
		Mineral Sources	Ion	Method	Source	Mineral Sources	Ion	Method	Source	Mineral Sources	Ion	Method	Source
SO <sub>4</sub>	Chalcophile	Chalcopyrite > pyrrhotite	SO <sub>4</sub> <sup>2-</sup>	SO <sub>4</sub> Rate	HCT	Pyrrhotite > chalcopyrite > pentlandite	SO <sub>4</sub> <sup>2-</sup>	SO <sub>4</sub> Rate	HCT	Pyrrhotite	SO <sub>4</sub> <sup>2-</sup>	SO <sub>4</sub> Rate	HCT
Alkalinity	Atmophile	Calcite, dolomite	CO <sub>3</sub> <sup>2-</sup>	Alkalinity Rate	HCT	Calcite, dolomite	CO <sub>3</sub> <sup>2-</sup>	Alkalinity Rate	HCT	-	-	-	-
Ca	Lithophile	Anorthite, calcite	Ca <sup>2+</sup>	Ca Rate	HCT	Anorthite, calcite	Ca <sup>2+</sup>	Ca/SO <sub>4</sub> Rate, Condition 2	HCT	Anorthite	Ca <sup>2+</sup>	Ca/SO <sub>4</sub> Rate, Condition 3	HCT
Mg	Lithophile	Olivine	Mg <sup>2+</sup>	Mg Rate	HCT	Olivine	Mg <sup>2+</sup>	Mg/SO <sub>4</sub> Rate, Condition 2	HCT	Mg silicates	Mg <sup>2+</sup>	Mg/SO <sub>4</sub> Rate, Condition 3	HCT
Na	Lithophile	Albite	Na <sup>+</sup>	Na Rate	HCT	Albite	Na <sup>+</sup>	Na/SO <sub>4</sub> Rate, Condition 2	HCT	Albite	Na <sup>+</sup>	Na/SO <sub>4</sub> Rate, Condition 3	HCT
K	Lithophile	Biotite	K <sup>+</sup>	K Rate	HCT	Biotite	K <sup>+</sup>	K/SO <sub>4</sub> Rate, Condition 2	HCT	Biotite	K <sup>+</sup>	K/SO <sub>4</sub> Rate, Condition 3	HCT
Ag	Chalcophile	Sulfide	Ag <sup>+</sup>	Ag/S	Aqua Regia	Sulfide	Ag <sup>+</sup>	Ag/S	Aqua Regia	Sulfide	Ag <sup>+</sup>	Ag/S	Aqua Regia
Al	Lithophile	Anorthite, albite	Al <sup>3+</sup>	Al/Ca (anorthite) + Al/Na (albite)	Mineral forumulae	Anorthite, albite	Al <sup>3+</sup>	Al/Ca (anorthite) + Al/Na (albite)	Mineral forumulae	Anorthite, albite	Al <sup>3+</sup>	Al/Ca (anorthite) + Al/Na (albite)	Mineral forumulae
As	Chalcophile	Sulfide	HAsO <sub>4</sub> <sup>2-</sup>	As/S	Aqua Regia	Sulfide	HAsO <sub>4</sub> <sup>2-</sup> / H <sub>2</sub> AsO <sub>4</sub> <sup>-</sup>	As/S	Aqua Regia	Sulfide	HAsO <sub>4</sub> <sup>2-</sup> / H <sub>2</sub> AsO <sub>4</sub> <sup>-</sup>	As/S	Aqua Regia
B	Lithophile	Unknown	H <sub>3</sub> BO <sub>3</sub>	B Rate	HCT	Unknown	H <sub>3</sub> BO <sub>3</sub>	B Rate	HCT	Unknown	H <sub>3</sub> BO <sub>3</sub>	B Rate	HCT
Ba	Lithophile	Biotite	Ba <sup>2+</sup>	Ba/K Ratio	Aqua Regia	Biotite	Ba <sup>2+</sup>	Ba/K Ratio	Aqua Regia	Biotite	Ba <sup>2+</sup>	Ba/K	Aqua Regia
Be	Lithophile	Biotite	Be <sup>2+</sup>	Be/K Ratio	Aqua Regia	Biotite	Be <sup>2+</sup>	Be/K Ratio	Aqua Regia	Unknown	Be <sup>2+</sup>	Be/S	Aqua Regia
Cd	Chalcophile	Sulfide	Cd <sup>2+</sup>	Cd/Zn Rate, Condition 2	HCT	Sulfide	Cd <sup>2+</sup>	Cd/Zn Rate, Condition 2	HCT	Pyrrhotite	Cd <sup>2+</sup>	Cd/S	Aqua Regia
Co	Siderophile	Olivine	Co <sup>2+</sup>	Co/Ni Rate, Condition 2	HCT	Olivine	Co <sup>2+</sup>	Co/Ni Rate, Condition 2	HCT	Pyrrhotite	Co <sup>2+</sup>	Co/S	Aqua Regia
Cr	Lithophile	Unknown	CrOH <sup>2+</sup>	Cr Rate	HCT	Unknown	CrOH <sup>2+</sup>	Cr Rate	HCT	Unknown	CrOH <sup>2+</sup>	Cr Rate	HCT
Cu	Chalcophile	Chalcopyrite	Cu <sup>2+</sup>	Cu/S	Aqua Regia	Chalcopyrite	Cu <sup>2+</sup>	Cu/S	Aqua Regia	Pyrrhotite	Cu <sup>2+</sup>	Cu/S	Aqua Regia
F	Lithophile	Apatite	F <sup>-</sup>	F rate	HCT	Apatite	F <sup>-</sup>	F rate	HCT	Apatite	F <sup>-</sup>	F Rate	HCT
Fe	Siderophile	Sulfides, silicates	Fe <sup>3+</sup>	Fe/S (pyrrhotite) + Fe/Mg (olivine)	Microprobe	Sulfides, Silicates	Fe <sup>3+</sup>	Fe/S (pyrrhotite) + Fe/Mg (olivine)	Microprobe	Sulfides	Fe <sup>3+</sup>	Fe/SO <sub>4</sub> Rate	HCT
Hg	Chalcophile	Sulfide	Hg <sup>2+</sup>	Hg/S	Aqua Regia	Sulfide	Hg <sup>2+</sup>	Hg/S	Aqua Regia	Pyrrhotite	Hg <sup>2+</sup>	Hg Rate	HCT
Mn	Siderophile	Sulfide	Mn <sup>2+</sup>	Mn/SO <sub>4</sub> Rate, Condition 2	HCT	Sulfide	Mn <sup>2+</sup>	Mn/SO <sub>4</sub> Rate, Condition 2	HCT	Pyrrhotite	Mn <sup>2+</sup>	Mn Rate	HCT
Mo	Siderophile	Molybdenite	MoO <sub>4</sub> <sup>2-</sup>	Mo/S	Aqua Regia	Molybdenite	MoO <sub>4</sub> <sup>2-</sup>	Mo/S	Aqua Regia	Pyrrhotite	H <sub>2</sub> MoO <sub>4</sub>	Mo/S	Aqua Regia
Ni	Siderophile	Pyrrhotite (assume more reactive than chalcopyrite) / olivine	Ni <sup>2+</sup>	Ni/S (pyrrhotite) + Ni/Mg (olivine)	Microprobe	Pyrrhotite (assume more reactive than chalcopyrite) / olivine	Ni <sup>2+</sup>	Ni/S (pyrrhotite)	Microprobe	Pyrrhotite	Ni <sup>2+</sup>	Ni/S	Aqua Regia
Pb	Chalcophile	Sulfide	Pb <sup>2+</sup>	Pb/S	Aqua Regia	Sulfide	Pb <sup>2+</sup>	Pb/S	Aqua Regia	Pyrrhotite	Pb <sup>2+</sup>	Pb/S	Aqua Regia
Sb	Chalcophile	Sulfide	Oxyanion	Sb/S	Aqua Regia	Sulfide	Oxyanion	Sb/S	Aqua Regia	Pyrrhotite	Oxyanion	Sb/S	Aqua Regia
Se	Chalcophile	Chalcopyrite	SeO <sub>4</sub> <sup>2-</sup>	Se/S	Aqua Regia	Chalcopyrite	SeO <sub>4</sub> <sup>2-</sup>	Se/S	Aqua Regia	Pyrrhotite	H <sub>2</sub> SeO <sub>3</sub>	Se/S	Aqua Regia
Tl	Chalcophile	Unknown	Tl <sup>+</sup>	Tl Rate	HCT	Unknown	Tl <sup>+</sup>	Tl Rate	HCT	Pyrrhotite	Tl <sup>+</sup>	Tl Rate	HCT
V	Lithophile	Biotite	VO <sub>2</sub> (OH) <sup>2-</sup>	V/K	Aqua Regia	Biotite	VO <sub>2</sub> (OH) <sup>2-</sup>	V/K	Aqua Regia	Biotite	VO <sub>2</sub> <sup>+</sup>	V/K	Aqua Regia
Zn	Chalcophile	Olivine	Zn <sup>2+</sup>	Zn/Mg	Aqua Regia	Pyrrhotite, olivine	Zn <sup>2+</sup>	Zn/Ni Rate, Condition 2	HCT	Pyrrhotite	Zn <sup>2+</sup>	Zn/S	Aqua Regia

Source: G:\PolyMet Mining\1UP005.01\_Northmet\_project\_2004\Water\_Quality\_Predictions\Waste\_Rock\2010-12\_Scale-Up\_Factor\_Discussion\Modelling\_Approach\ModellingApproachByParameter\_1UP005001\_SJD\_REV00.xlsx

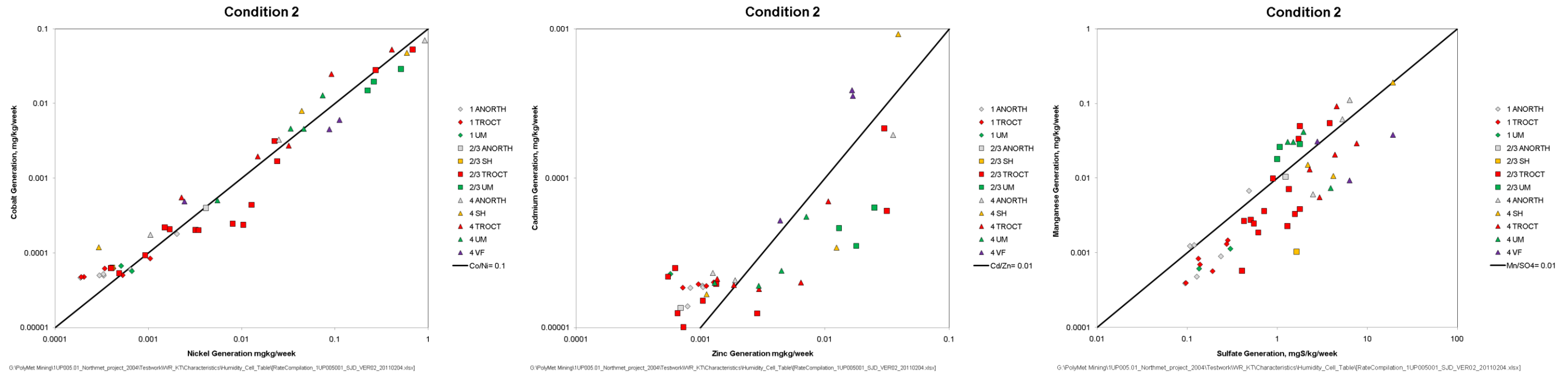

Figure 1. Specific Relationships from Humidity Cells Used to Understand Mineral Hosts. Refer to Section 2.5 for explanation of leachate condition used to generate plots.



### 2.3 Identification of Soluble Ion for Ratios

Based on the above mineralogical conclusions, sulfate, magnesium and potassium were identified as primary ions that are readily soluble components of major mineral hosts that will be released as weathering products.

A few other strong secondary relationships were identified based on correlations between release rates in humidity cells, as shown in Figure 1. Cadmium and zinc release are correlated indicating a Cd/Zn ratio of about 0.001 (mg/mg). Likewise cobalt and nickel release are also strongly correlated showing Co/Ni of about 0.1 (mg/mg). Cadmium is therefore predicted from zinc release and the observed ratio, cobalt is predicted from nickel release and the observed ratio. Manganese and sulfate release are correlated with a Mn/SO<sub>4</sub> ratio of about 0.01 (mg/mg), and manganese is predicted from sulfate release and the observed ratio (not the solid Mn/S ratio).

### 2.4 Quantification of Solid Ratios for Calculation of Release Rates

Table 1 shows the approach proposed to obtain solids ratios for each parameter in each category.

For Category 1, the low sulfide content indicates that acid generation from sulfide oxidation may be subordinate to general silicate weathering as a source of metals contained in both silicates and sulfides. Weathering of silicates is therefore considered separately for Category 1.

Primary release rates for Category 1 are based on sulfate, magnesium and potassium as indicated by humidity cell results. For most elements, metal to sulfur, metal to magnesium, and metal to potassium ratios indicated by aqua regia digestion of rock samples will be used to predict metal release based on the primary release rates. Nickel and iron release will be calculated from metal to sulfur and metal to magnesium ratios indicated by microprobe data for pyrrhotite and olivine. This is preferred over bulk solids analysis because it provides direct measurements of the minerals and the data are already available. A similar approach will be used for aluminum, based on the mineral formulae for anorthite and albite rather than microprobe data. For boron, chromium and thallium, direct rates for humidity cells will be used due to the lack of correlation with any of the known major mineral hosts.

For Category 2/3 and 4 Duluth Complex rocks, by definition, acid generation from sulfide oxidation is the major process driving these rock types to become acidic at some point. As a result, dissolution of silicates is linked to acid generation. As shown in Table 1, magnesium and potassium release rates are correlated with sulfate release and therefore would be calculated from sulfate. Other solids ratios are based on the same mineralogical assumptions as Category 1. For zinc, a strong correlation with nickel leaching is apparent in acidic humidity cells, and zinc release would be based on the zinc to nickel ratio.

For Virginia Formation Category 4, solids ratios would largely be based on the strong relationships between sulfur content and metal content. The solids ratios are not necessarily same as for Duluth Complex Category 4 due to the fundamental difference in rock type and mineralogy.

### 2.5 Release Rates

Humidity cell data have been completely re-interpreted to obtain data for this assessment. Trends for each humidity cell were examined to understand oxidation rates under changing weathering conditions. Five different leachate conditions were recognized and used to calculate rates:

- Condition 0: Brief (a few weeks) initial flushing of weathering products accumulated in storage. No rates were calculated for this period because a time period cannot be assigned to reflect core and sample storage prior to testing.
- Condition 1: Sulfate release relatively stable and leachate pH above about 7.
- Condition 2: Sulfate release relatively stable, leachate pH below about 7, nickel release unstable and typically increasing.
- Condition 3: Sulfate release increasing and variable, leachate pH decreasing further.
- Condition 4: Sulfate release decreasing following a peak usually under acidic conditions.

An example of a test showing all five conditions is shown in Figure 2. Condition 1 begins after week 0 as the initial flushing effect was relatively minor. During Condition 1, leachate pH decreased. Condition 2 begins at week 39 roughly marking when pH dropped below a level which allowed nickel release to be increasing. The beginning of Condition 3 started when sulfate release increased rapidly (along with pH decrease) reaching a peak. Condition 4 is defined as starting when peak sulfate release was reached.

Charts showing assignment of conditions to all tests are provided in Attachment 2. Table 2 summarizes identified conditions.

As shown in Figure 2, Condition 2 is considered to be sufficiently acidic to allow elements such as cadmium, cobalt, manganese and zinc to be released without significant attenuation as secondary minerals. Experiments by both MDNR and PolyMet show that release of these elements from kinetic tests accelerate as pH decreases below 7.

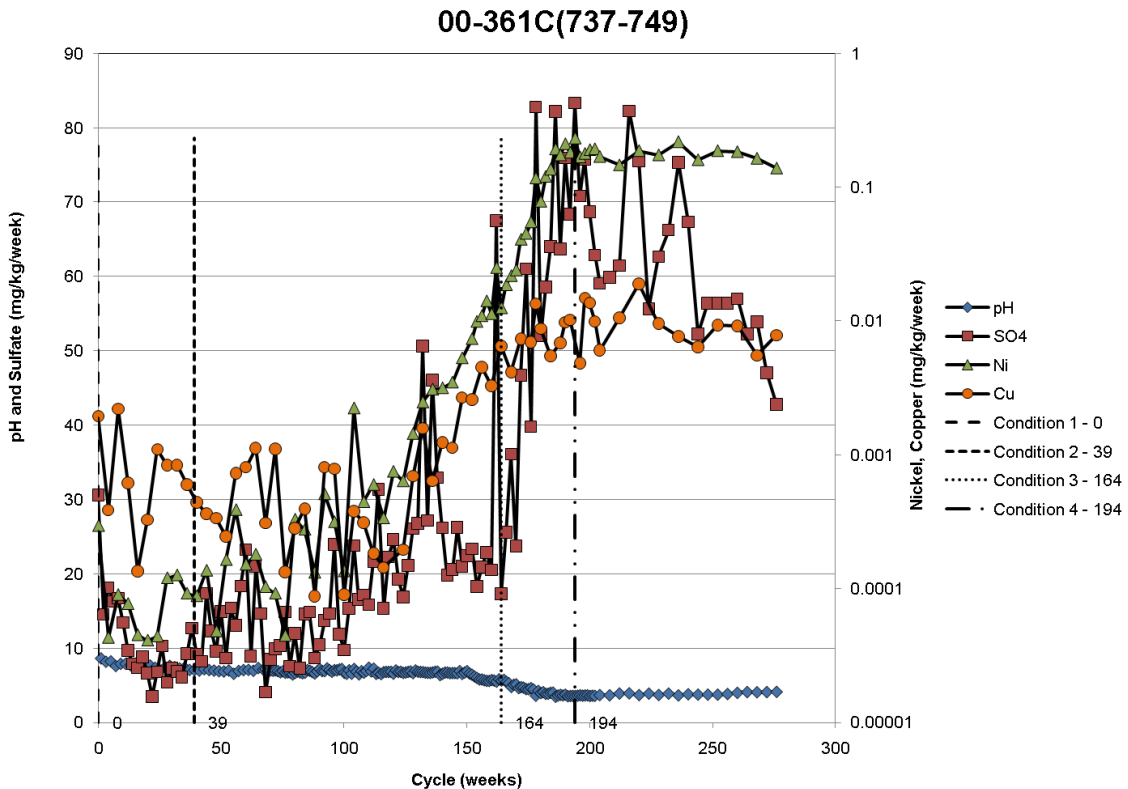

G:\PolyMet Mining\1UP005\_01\_Northmet\_project\_2004\Testwork\WWR\_KTR\Results\Charts\Trend\_Analysis\{RWR\_Trend\_Analysis\_1UP005001\_SJD\_20110201\_VER00.xlsx}

**Figure 2. Example of Leachate Conditions for a Humidity Cell**

**Table 2. Summary of Conditions Applied to NorthMet Project Humidity Cells**

Rock Type	Waste Category	Sample ID	S	Condition 1 Start	Condition 2 Start	Condition 3 Start	Condition 4 Start	Total Duration
			%	week	week	week	week	week
Anorthositic	1	99-320C(830-850)	0.09	4	179	-	-	284
Anorthositic	1	00-361C(345-350)	0.05	6	184	-	-	284
Anorthositic	1	00-366C(185-205)	0.02	0	-	-	-	198
Anorthositic	1	00-366C(230-240)	0.02	4	60	-	-	198
Anorthositic	1	99-320C(165-175)	0.03	0	72	-	-	198
Anorthositic	1	00-334C(30-50)	0.02	4	-	-	-	284
Anorthositic	1	00-368C(125-145)	0.04	0	80	-	-	284
Anorthositic	1	00-368C(20-40)	0.04	0	80	-	-	198
Troctolitic	1	00-340C(595-615)	0.04	0	-	-	-	198
Troctolitic	1	00-334C(580-600)	0.06	1	179	-	-	284
Troctolitic	1	00-334C(640-660)	0.07	12	224	-	-	284
Troctolitic	1	00-347C(795-815)	0.07	0	103	-	-	198
Troctolitic	1	99-318C(250-270)	0.04	0	72	-	-	198
Troctolitic	1	00-373C(95-115)	0.04	0	-	-	-	198
Troctolitic	1	00-373C(75-95)	0.06	0	-	-	-	198
Troctolitic	1	00-357C(110-130)	0.08	10	-	-	-	198
Troctolitic	1	99-320C(315-330)	0.07	4	-	-	-	284
Troctolitic	1	00-366C(35-55)	0.02	0	-	-	-	198
Troctolitic	1	00-334C(110-130)	0.04	0	-	-	-	198
Troctolitic	1	00-347C(155-175)	0.06	0	72	-	-	198
Troctolitic	1	00-347C(280-300)	0.06	16	65	-	-	198
Troctolitic	1	00-367C(50-65)	0.03	0	-	-	-	198
Troctolitic	1	00-367C(260-280)	0.04	0	-	-	-	198
Troctolitic	1	00-367C(290-310)	0.04	0	-	-	-	284
Troctolitic	1	00-370C(20-30)	0.08	10	-	-	-	198
Troctolitic	1	26064(44-54)	0.02	0	-	-	-	284
Troctolitic	1	26064(264+146269+156)	0.06	4	-	-	-	284
Troctolitic	1	26056(110-125)	0.04	0	-	-	-	198
Troctolitic	1	26029(815-825)	0.02	0	-	-	-	194
Troctolitic	1	26056(135-153)	0.05	0	-	-	-	278
Troctolitic	1	00-326C(250-265)	0.08	4	-	-	-	186
Ultramafic	1	00-357C(335-340)	0.08	12	187	-	-	198
Ultramafic	1	00-368C(460-465)	0.06	0	-	-	-	198
Ultramafic	1	26055(940-945)	0.06	16	-	-	-	198
Ultramafic	1	26098+00-337C	0.1	0	-	-	-	198
Ultramafic	1	00-361C(240-245)	0.06	14	184	-	-	284
Ultramafic	1	26039(310-315)	0.06	8	-	-	-	186
Ultramafic	1	00-326C(225-235)	0.12	8	-	-	-	273
Anorthositic	2/3	00-361C(310-320)	0.18	0	111	-	-	284
Anorthositic	2/3	99-320C(400-405)	0.18	14	-	-	-	273
Sedimentary Hornfels	2/3	26030(1047-1052)	0.24	53	-	-	-	284
Sedimentary Hornfels	2/3	26061(1218-1233)	0.44	4	-	-	-	284
Sedimentary Hornfels	2/3	00-340C(990-995)	0.55	0	189	-	-	284
Troctolitic	2/3	00-350C(580-600)	0.19	0	196	-	-	284
Troctolitic	2/3	00-327C(225-245)	0.44	0	182	-	-	198
Troctolitic	2/3	00-369C(335-345)	0.18	4	181	-	-	284
Troctolitic	2/3	00-326C(60-70)	0.14	0	75	-	-	284
Troctolitic	2/3	00-369C(305-325)	0.25	4	187	-	-	198
Troctolitic	2/3	00-369C(20-30)	0.21	0	187	-	-	284
Troctolitic	2/3	00-367C(170-175)	0.51	0	172	-	-	284
Troctolitic	2/3	00-340C(380-390)	0.15	4	-	-	-	198
Troctolitic	2/3	26049+26030	0.59	4	-	-	-	198
Troctolitic	2/3	26056(302-312)	0.23	12	212	-	-	284
Troctolitic	2/3	26142(360+345-365+350)	0.18	0	168	-	-	284
Troctolitic	2/3	99-318C(325-330)	0.17	0	180	-	-	273
Troctolitic	2/3	26056(282-292)	0.32	2	178	-	-	186
Troctolitic	2/3	00-340C(910-925)	0.36	0	72	110	180	273
Troctolitic	2/3	00-331C(190-210)	0.42	0	48	201	-	273
Troctolitic	2/3	00-367C(495-500)	0.28	8	114	-	-	273
Ultramafic	2/3	00-326C(680-685)	0.30	0	69	-	-	198
Ultramafic	2/3	00-357C(535-540)	0.2	0	78	-	-	284
Ultramafic	2/3	00-344C(630-635)	0.34	0	51	160	-	186
Ultramafic	2/3	00-326C(495-505)	0.16	0	-	-	-	186
Anorthositic	4	00-343C(240-250)	0.68	0	161	-	-	198
Anorthositic	4	26027(616-626)	1.83	4	18	24	-	284
Anorthositic	4	00-331C(255-260)	0.86	0	19	162	184	273
Sedimentary Hornfels	4	00-340C(965-974.5)	1.74	0	25	34	80	198
Sedimentary Hornfels	4	26043+26027	2.47	0	9	26	48	284
Sedimentary Hornfels	4	26062+26026	4.46	0	3	3	-	284
Sedimentary Hornfels	4	26058(704-715)	1.46	8	41	-	-	273
Troctolitic	4	00-371C(435-440)	0.88	0	51	90	196	284
Troctolitic	4	00-340C(765-780)	1.68	0	61	82	-	284
Troctolitic	4	00-367C(395-400)	0.77	0	82	-	-	198
Troctolitic	4	00-340C(725-745)	0.91	6	118	-	-	198
Troctolitic	4	00-367C(400-405)	1.37	4	39	78	-	198
Ultramafic	4	99-318C(725-735)	0.72	0	96	-	-	198
Ultramafic	4	99-317C(460-470)	1.24	0	39	-	-	198
Ultramafic	4	00-344C(515-520)	1.2	4	47	152	-	198
Ultramafic	4	00-330C(275-280)	0.75	0	164	-	-	186
Virginia	4	00-361C(737-749)	2	0	39	164	194	284
Virginia	4	00-364C(210-229)	3.79	0	0	5	-	198
Virginia	4	00-337C(510-520)	5.68	0	0	5	-	198
Ore Composite	4	P10	0.86	4	88	-	-	268
Ore Composite	4	P20	0.9	6	88	-	-	268
Ore Composite	4	P30	0.86	6	88	-	-	268

Source: G:\PolyMet Mining\1UP005.01\_Northmet\_project\_2004\Water\_Quality\_Predictions\Waste\_Rock\2011-02\_Collected\_Inputs\_for\_Modeling\HCT\_Data\Rates\_1UP005001\_SJD\_VER00\_20110301.xlsx

Notes: “-” condition not observed.

## 2.6 Incorporation of Acidification Effects into Release

Acidification effects for Cat 2/3 and 4 will be incorporated using the previous approach to estimate acceleration of oxidation and acid release rates. These effects are mainly quantified through reference to the MDNR’s long term testwork and include:

- Time to acceleration of sulfide oxidation (time from start of test to start of Condition 3).
- Ratio of peak of sulfide oxidation rate to pre-peak oxidation rates (Condition 4 to Condition 2 ratio).
- Decay curve for sulfide oxidation rates post-peak (decrease after start of Condition 4).

Data from NorthMet Project humidity cells are beginning to provide information on the increase in oxidation rates as pH decreases though the increases are less than the ten times factors observed in DNR tests (Figure 3). DNR tests used to characterize these features are shown in Table 3.

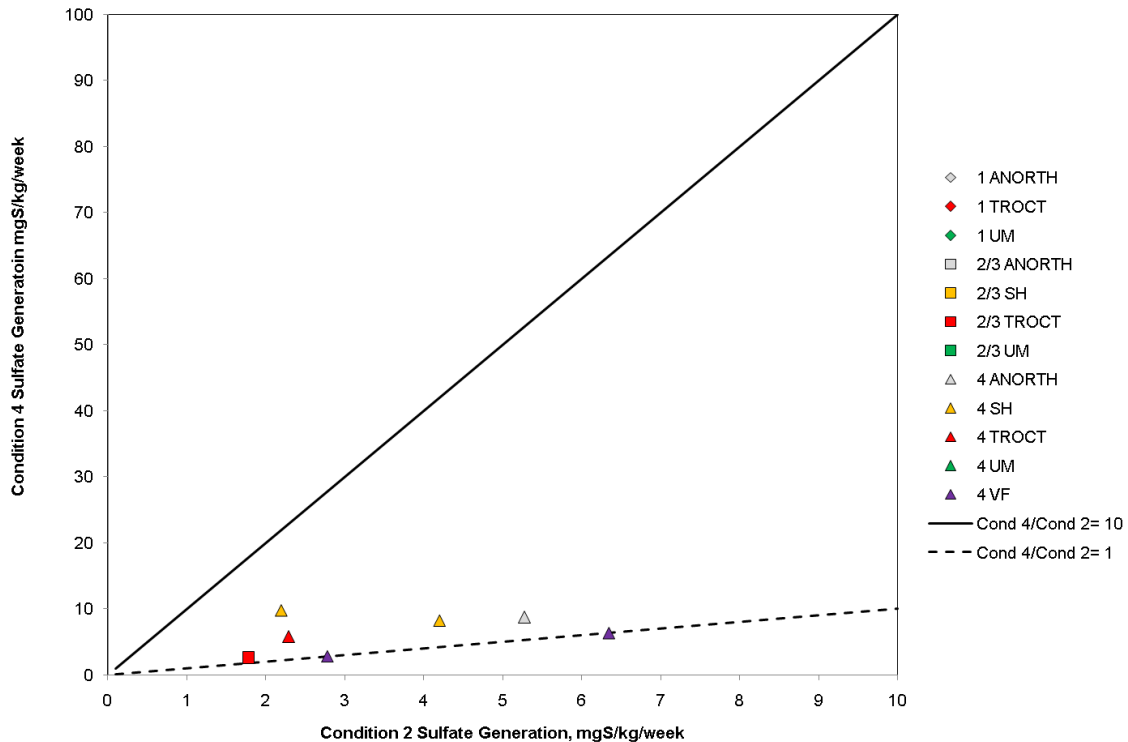

G:\PolyMet Mining\1UP005.01\_Northmet\_project\_2004\Testwork\WR\_KT\Characteristics\Humidity\_Cell\_Table\RateCompilation\_1UP005001\_SJD\_VER02\_20110204.xlsx

**Figure 3. Comparison of Condition 2 and Condition 4 Rates for NorthMet Project Humidity Cells**

**Table 3: MDNR’s Long Term Testwork Used to Characterize Delay to Onset, Peak Oxidation Rates and Decay Curves**

Dunka Blast Hole Sample Reactor	S	NorthMet Waste Rock Category	Time to Acceleration and Peak to Pre-Peak	Decay Curve
	%			
7	0.41	2/3	X	X
9	0.51	2/3	X	X
10	0.51	2/3	X	
12	0.54	2/3	X	
11	0.54	2/3	X	
14	0.57	2/3	X	
13	0.57	2/3	X	
15	0.58	2/3	X	X
16	0.58	2/3	X	
39	0.67	4	X	
17	0.71	4	X	X
35	1.12	4	X	
29	1.16	4	X	X
37	1.40	4	X	
33	1.44	4	X	X
19	1.63	4	X	X
31	1.64	4	X	

Source: \\Van-svr0.van.na.srk.ad\ge\_projects\PolyMet Mining\1UP005.01\_Northmet\_project\_2004\Background\_Docs\MDNR\_Testwork\F.Dunka\_Blast\_Hole\_Small\_Reactors\Data\_analysis\[Decay\_Curves\_1UP005001\_ver02\_SJD.xlsx]  
 \\Van-svr0.van.na.srk.ad\ge\_projects\PolyMet Mining\1UP005.01\_Northmet\_project\_2004\Background\_Docs\MDNR\_Testwork\F.Dunka\_Blast\_Hole\_Small\_Reactors\Data\_analysis\[SO4\_Acceleration\_Factors\_1UP005001\_VER02.xls]

Since the majority of release rates are linked explicitly to sulfate release which tracks release from source minerals, other rates will also change by the same factors. For parameters not linked to sulfate, actual measured rates from humidity cells (defined using observed Condition 2 and Condition 3) will be used.

### 3 Quantification of Leaching

#### 3.1 Conceptualization

As indicated above, release refers to the transfer of potential contaminants from primary solid phase to weathering products. Leaching refers to the transfer to the aqueous phase and leaching from the facility. Leaching is modeled by consideration of the solubility of the weathering products.

For the expected well-oxygenated conditions in the waste rock piles and pit walls, the dominant control on leaching is expected to be pH with oxidation-reduction potential being a lesser or negligible effect. An additional consideration is the kinetics of leaching which may result in concentrations below the theoretical or maximum solubility of a weathering product.

#### 3.2 Data Sources

##### 3.2.1 Background

Due to the limitation of thermodynamic models for the majority of trace contaminants, and limited understanding of the kinetics of leaching, the previous approach has been to use analog data to provide solubility limits. The only true analog data available for the site is the AMAX stockpiles;

however, concerns have been raised about the suitability of these due to their relatively small size (potentially lower concentrations than full scale), high commodity element content (higher concentrations than waste rock particularly for Category 1) and lack of data on the full suite of elements needed for water quality modeling.

To evaluate these concerns, the following specific searches were completed:

- Means to simulate Category 1 type material.
- Examples of comparisons of small tests with full scale piles.
- Relevant geological analogs particularly for acid rock drainage.

### 3.2.2 Category 1 Solubility Controls

A previous search for drainage chemistry from Category 1 type waste materials was not fruitful. One site (Lac des Iles Mine, Ontario, Canada) was identified as having similar waste rock; however, the operator does not monitor drainage chemistry. The recommended approach is in general to use the results of the SMWMP experiment reported separately (SRK 2011<sup>3</sup>). Some elements were not constrained by the experiment and would be constrained from mineral solubility indicated by thermodynamic modeling:

- Sulfate – Calculated from  $SO_4$  (mg/L) =  $1294.(Mg+0.5.Na+0.5K)/Ca + 1760$ . The ion ratio is expressed as moles and is obtained from the release rates indicated by Condition 2 of humidity cells. This equation indicates gypsum solubility of 1760 mg/L if Mg, Na and K are not present. Median solubility is 2700 mg/L.
- Calcium – Calculated from sulfate (mg/L), sodium (mmol/L) and potassium (mmol/L) concentrations using the above equation:  $Ca$  (mmol/L) =  $1294(Mg+0.5Na+0.5K)/(SO_4-1760)$
- Barium – based on barite solubility as a sulfate ( $\log_{10}Ba = -0.32.\log_{10}SO_4-0.87$ ).
- Copper – tenorite solubility as a function of pH (0.04 to 0.07 mg/L between pH 8 and 7.5).
- Fluoride – based on fluorite solubility as a function of Ca ( $\log_{10}F = -0.298.\log_{10}Ca-0.817$ ).
- Molybdenum – 1.1 mg/L based on powellite solubility at typical calcium concentrations.
- Selenium – Calculated from  $Se$  (mg/L) =  $6.35 \times 10^{-6}.SO_4 + 0.0020$ .

### 3.2.3 Comparisons of Acidic Drainage Solubility Controls

Opportunities to compare tests performed at different scales were sought to evaluate the suitability of the AMAX stockpiles as analogs for full scale waste rock stockpiles. SRK has access to three datasets that include a full range of comparisons between laboratory tests, different fields scale tests and full scale. Two of the datasets are from coal mines with no ARD and therefore considered to have limited value to the NorthMet Project. The comparisons showed that small scale (eg <1 tonne) field tests show the same chemistry as full scale facilities.

To support drainage chemistry prediction for another project (see Day and Rees 2006<sup>4</sup>), SRK compiled data for porphyry open pit mines in Western Canada. These sites are not analogs for copper-nickel mining in the Duluth Complex but there are some examples of comparisons of smaller scale tests with full scale monitoring. The dataset consists of seven sites:

- Three are older sites with acid rock drainage and data are for monitoring of waste rock stockpiles.
- Two are older sites without ARD again with monitoring of waste rock stockpiles.

<sup>3</sup> SRK Consulting. 2011. Results of an experiment to evaluate solubility limits for Category 1 waste rock, NorthMet Project. Draft Memorandum, SRK Project 1UP005.001. February 16, 2011.

<sup>4</sup> Day, S. and Rees, B. 2006. Geochemical Controls on Waste-Rock Dump Seepage Chemistry at Several Porphyry Mines in The Canadian Cordilleran. Paper was presented at the 2006, 7th ICARD, March 26-30, 2006, St Louis MO. Published by ASMR, 3134 Montavesta Road, Lexington, KY 40502.

- Two sites are more recently developed. One of these has a long term column test which has generated ARD. No comparable full scale data are available because the mine has been designed to mitigate ARD potential. One site has numerous small-scale field pads. Some of these have generated ARD.

Data are provided as charts in Attachment 3.

The dataset indicates that for the gross parameters indicating acid generation and buffering reactions, sulfate concentrations were with the same order-of-magnitude for each scale though slightly higher at full scale, and iron and aluminum concentrations were similar at all scales. Trace element concentrations were variable and are probably affected by site mineralogy. Copper concentrations in the column leachate were very similar to those at full scale for two sites where copper is the main commodity. Leach pad copper concentrations were over an order of magnitude lower than these concentrations though copper concentrations are low at this site. Nickel data were limited but the column and leach pads both yielded higher concentrations than seen in ARD for one mine. Zinc concentrations in leach pads and columns were comparable to the full scale mines but likely reflect the variable occurrence of zinc sulfide in porphyry copper deposits.

In general, the comparison shows that concentration differences were not reflective of scale and water-to-rock differences. For example, the range of sulfate concentrations in ARD would be expected to span several orders of magnitude if test size were a major control on ARD potential. This does not appear to be the case.

The finding indicates that AMAX test stockpile drainage chemistry provides a reasonable indication of drainage chemistry because scale effects appear to be relatively minor.

A limitation of the AMAX test stockpile data is that the dataset likely includes low concentrations which do not reflect solubility constraints but are a result of dilution of drainage waters by snowmelt and rainstorm events. Higher concentrations in the dataset are more likely to reflect solubility constraints based on the above comparisons.

### 3.2.4 Relevant Geological Analogs

#### *Duluth Complex Waste Rock (Category 2, 3 and 4)*

SRK has sought drainage chemistry data for waste rock produced by mining in similar geological settings (layered mafic intrusions) with particular emphasis on locating chemistry data for trace elements not determined in the drainage from the AMAX test stockpiles.

Information in the literature was very limited, and contact with mining companies was unsuccessful. A 5 million tonne waste rock stockpile at the Whistle Mine in the Sudbury Basin in Ontario, Canada was studied under the MEND program (Vos et al. 1997<sup>5</sup>). Waste rock at the site is norite which is similar in composition to gabbro. The main rock type in the Duluth Complex is troctolite which is a type of gabbro containing less pyroxene than gabbro. Construction of the waste rock stockpile started in 1988. All waste rock was backfilled to the open pit between July 2000 and December 2001<sup>6</sup>.

Sampling of the stock pile indicated average sulfur concentrations of about 2% though the pile also contains rock that is semi-massive sulfide. Drainage chemistry monitoring in 1995 and 1996

<sup>5</sup> Vos, K.J., Pettit, C., Martin, J., Knapp, R.A. and Jansons, K.J. Whistle Mine Waste Rock Study. MEND Report 1.41.1. October, 1997.

<sup>6</sup> Ayres, B., Lanteigne, L., and O'Kane, M., 2005. Design and construction of the backfilled pit cover system at Whistle Mine, Canada: a case study. Securing the Future 2005, International Conference on Mining and the Environment, Skelleftea, Sweden, June 27-July 1, 2005.

included sampling of seeps and groundwater in close proximity to the pile. As a result, concentrations are not expected to have a strong effect from diluting events such as snowmelt and rainstorms. Water quality is expected to come close to source water concentrations. The data are provided in Attachment 4.

Table 4 summarizes data for acidic ( $\text{pH} < 4.5$ ) waters. For trace elements, detection limits were higher than available currently and variable through the study. The summary provided in Table 4 is based on only reported values above the lowest detection limit. The distributions do not include the higher detection limits, hence the number of values available is not the same for each parameter.

For comparison, Table 4 also includes the deterministic values in RS42 to represent solubility at pH 3.5. The Whistle Mine 95th percentile values and the RS42 values were within the same order of magnitude for most parameters. Exceptions are aluminum, copper, barium, beryllium, cadmium, chromium, lead, antimony and selenium. The elevated aluminum concentrations may reflect the abundance of anorthite in norite compared to gabbro. Copper concentrations were greater in the AMAX stockpiles drainage compared to the Whistle Mine waste rock.

For some of the remaining elements, the variable detection limits may partly be a factor leading to elevated but poorly quantified values. For chromium, detections were not normal and most values were below 0.01 mg/L. For lead, concentrations if detected tended to be near the detection limit in use at the time and concentrations were typically below 0.5 mg/L. The maximum lead value in the dataset was 11 mg/L which was more than an order of magnitude higher than the next nearest value of 0.6 mg/L. Antimony concentrations were always near the detection limit which was commonly 1 mg/L. The apparent concentrations in the 2 to 3 mg/L range appear to be a function of uncertainty near the detection limits. Selenium was never detected and the lowest detection limit was 0.1 mg/L.



**Table 4: Summary of Acidic (pH<4.5) Seepage and Groundwater Data for Whistle Mine Waste Rock Stockpile (Vos et al. 1997).**

Parameter	Units	DL	n	P5	Median	P95	RS42 (Table 7-2) Deterministic Values	
							AMAX Pile	Other
pH	mg/L	-	30	3.8	4.2	4.5	-	
Eh	mg/L	-	30	87	260	400	-	
Conductivity	mg/L	-	28	4200	8700	11000	-	
SO <sub>4</sub>	mg/L	-	29	4300	9200	18000	9600	
Ag	mg/L	0.005	4	0.036	0.05	0.05	-	
Al	mg/L	0.5	22	120	370	930	83	
As	mg/L	0.1	9	<0.1	<0.1	<0.1		0.71
B	mg/L	0.01	12	0.1	0.2	0.4		0.76
Ba	mg/L	0.005	9	0.0091	0.015	0.019		0.19
Be	mg/L	0.005	22	<0.005	<0.005	0.02		0.0023
Cd	mg/L	0.01	12	0.055	0.12	0.33		0.015
Co	mg/L	0.01	29	11	33	42	44	
Cr	mg/L	0.01	9	<0.01	<0.01	0.015		0.0015
Cu	mg/L	0.01	25	1.2	11	28	200	
Fe	mg/L	0.1	29	3.3	130	250	240	
Mn	mg/L	0.01	29	22	55	93	47	
Ni	mg/L	0.05	29	250	680	820	760	
Pb	mg/L	0.05	3	0.15	0.36	0.58		0.053
Sb	mg/L	0.1	9	1.4	2	3		0.00001
Se	mg/L	0.1	1	-	<0.1	-		0.0029
V	mg/L	0.005	3	0.051	0.055	0.06	-	
Zn	mg/L	0.01	28	6.3	9	43	26	

Source: \\Van-svr0.van.na.srk.ad\ge\_projects\PolyMet Mining\1UP005.01\_Northmet\_project\_2004\Water\_Quality\_Predictions\Waste\_Rock\2011-01\_Waste\_Rock\_Analogs\Analog\_Sites\Whistle\_Mine\Whistle\_Mine\_1UP005001\_SJD\_VER00.xlsx]

### Virginia Formation

Leaching of the Virginia Formation waste rock and pit walls is expected to occur differently from Duluth Complex waste rock due to the different waste rock matrix and higher sulfur content. Since the protolith for this rock type is a black shale, waste rock analogs for this types of rock were sought. Direct analogs (i.e. slates containing pyrrhotite but not other types of mineralization) were not identified in the public record.

SRK has access to drainage chemistry data for three sediment hosted lead-zinc deposits. The Anvil Range Mine Complex (Vangorda Mine) is under public management to address acid rock drainage and therefore drainage chemistry data are available in the public record<sup>7</sup>. Table 5 summarizes distribution statistics for ARD from the waste rock stockpile which is collected from drains under the stockpile. Like Whistle Mine, these waters are expected to be dominated by contact waters rather than dilute surface waters.

Data are provided for monitoring location V32 in Attachment 5. Other monitoring locations are not acidic. Due to the presence of lead and zinc mineralization in the waste rock, zinc, lead and cadmium

<sup>7</sup> Gartner Lee Limited, 2007. Anvil Range Mine Complex 2006 Annual Environmental Report Water Licence QZ03-059. Prepared for Deloitte & Touche Inc. February 2007.

concentrations are very high and considered non-representative for the Virginia Formation. For these parameters, it is proposed to use data from the AMAX stockpiles.

**Table 5. Summary of Acidic Seepage Data for Vangorda Waste Rock Stockpile**

Parameter	Unit	n	P5	P50	P95
pH	-	33	2.8	3.7	5.4
SO <sub>4</sub>	mg/L	34	3600	13000	71000
Ag	mg/L	19	0.0064	0.03	0.21
Al	mg/L	31	1.8	7.9	420
As	mg/L	24	0.011	0.069	2
Ba	mg/L	30	0.005	0.092	1.1
B	mg/L	12	0.066	1.3	3.1
Be	mg/L	28	0.0052	0.011	0.24
Cd	mg/L	31	0.92	4.8	17
Co	mg/L	31	7.1	14	28
Cr	mg/L	13	0.0096	0.017	0.84
Cu	mg/L	30	0.033	0.1	0.35
Fe	mg/L	31	6	220	3800
Mn	mg/L	29	340	1200	3800
Ni	mg/L	31	4.3	9.6	21
Pb	mg/L	29	0.3	1.5	11
Sb	mg/L	25	0.001	2.5	8.9
Se	mg/L	14	0.073	0.12	2
Tl	mg/L	9	0.0079	0.012	0.018
V	mg/L	11	0.003	0.005	0.34
Zn	mg/L	31	840	3000	11000

Source: G:\PolyMet Mining\IUP005.01\_Northmet\_project\_2004\Water\_Quality\_Predictions\Waste\_Rock\2011-01\_Waste\_Rock\_Analogs\Analog\_Sites\Vangorda\Copy of Vangorda\_DumpDrainChemistry\_dbm\_rev00.xlsx

### 3.3 Summary of Solubility Constraints

Table 6 summarizes the proposed approach to define solubility constraints for each parameter based on the above discussion.

Category 1 values are based mainly on the SMWMP results referenced in Section 3.2.2 with the exception of elements which were not constrained by the procedure. Most of these non-constrained elements would be constrained by concentrations indicated by thermodynamic modeling. Sulfate would be calculated based on the solubility of gypsum varying as a function of ion ratios. Nickel would be constrained using the AMAX pile data for basic pH conditions indicated by the SMWMP results.

For non-acidic drainage from Category 2/3 waste rock, sulfate concentrations would be calculated based on the solubility of gypsum. Where data were available, metal concentrations would be constrained using AMAX pile data. For parameters not determined for the AMAX pile drainages, SMWMP data would be used if the experiment did not show concentrations varying as a function of sulfur content of the sample (Pb, Sb, Tl, V). Whistle Mine acidic concentrations would be used if the SMWMP data showed that sulfur concentrations are expected to be an important control.

For acidic drainage from Duluth Complex Category 2/3 waste rock and Category 4 mine walls, the main sources of constraints are the AMAX piles and Whistle Mine.

For Virginia Formation Category 4 waste rock and mine walls, the Vangorda Mine provides the constraints with the exception of Cd, Pb and Zn which would be assigned the values used for the Whistle Mine.

In terms of using solubility for the probabilistic analysis, the following approach is proposed for development of distributions:

- When using SMWMP data, distributions would be developed based on the concentrations indicated by the last leach cycle of the test data.
- When using Whistle Mine and Vangorda Mine data, the entire dataset in the indicated pH range will be used in each case based on the assumption that water chemistry reflects mainly contact conditions rather than dilution.
- When using AMAX stockpile data, the data would be assigned to 0.1 pH bins in the pH range. In each bin, concentrations at the 95<sup>th</sup> percentile and above would be extracted from the dataset, combined and used to determine overall concentration distribution. This approach removes waters from the dataset that may be dilute, respects the likely correlation of solubility constraints with pH and considers the uncertainty in pH range.

**Table 6. Summary of Solubility Constraint Approach for Each Parameter**

	Category 1		Non Acidic Duluth Category 2/3		Acidic Duluth Category 2/3/4		Virginia Formation (Cat 4)	
	Source	Comment	Source	Comment	Source	Comment	Source	Comment
SO <sub>4</sub>	Gypsum solubility		Gypsum solubility		Whistle Mine		Vangorda Mine	
Alkalinity	SMWMP		SMWMP		No alkalinity		No alkalinity	
Ca	Gypsum solubility		Gypsum solubility	See text	Whistle Mine		Vangorda Mine	
Mg	From Mg/Ca in SMWMP Leachate		From Mg/Ca SMWMP Leachate		Whistle Mine		Vangorda Mine	
Na	SMWMP		SMWMP		Whistle Mine		Vangorda Mine	
K	SMWMP		SMWMP		Whistle Mine		Vangorda Mine	
Ag	SMWMP		SMWMP	No S correlation	Whistle Mine		Vangorda Mine	
Al	SMWMP		SMWMP		Whistle Mine		Whistle Mine	
As	SMWMP		Whistle Mine		Whistle Mine		Vangorda Mine	
B	Whistle Mine		Whistle Mine		Whistle Mine		Vangorda Mine	
Ba	Barite solubility		Barite solubility		Barite solubility		Vangorda Mine	
Be	SMWMP		Whistle Mine		Whistle Mine		Vangorda Mine	
Cd	SMWMP		Cd/Zn ratio		Whistle Mine		Whistle Mine	No Cd, Pb, and Zn mineralization
Co	SMWMP		AMAX Pile pH 6 to 8		Whistle Mine	Comparable to AMAX	Vangorda Mine	
Cr	SMWMP		Whistle Mine		Whistle Mine		Vangorda Mine	
Cu	Model tenorite at pH 7.5 to 8		AMAX Pile pH 6 to 8		AMAX Pile pH 3 to 4	Higher than Whistle Mine	Vangorda Mine	
F	Fluorite solubility		Fluorite solubility		Fluorite solubility		Fluorite solubility	
Fe	SMWMP		SMWMP		Whistle Mine		Vangorda Mine	
Hg	Rock sorption data		Rock sorption data		Rock sorption data		Rock sorption data	
Mn	SMWMP		AMAX Pile pH 6 to 8		Whistle Mine	Comparable to AMAX	Vangorda Mine	
Mo	Model powellite		Model powellite		Model powellite		Vangorda Mine	
Ni	AMAX Pile pH 7 to 8		AMAX Pile pH 6 to 8		Whistle Mine	Comparable to AMAX	Vangorda Mine	
Pb	SMWMP		SMWMP	No S correlation	Whistle Mine		Whistle Mine	No Cd, Pb, and Zn mineralization
Sb	SMWMP		SMWMP	No S correlation	Whistle Mine		Vangorda Mine	
Se	Sequestered by gypsum		Sequestered by gypsum		Whistle Mine		Vangorda Mine	
Tl	SMWMP		SMWMP	No S correlation	Vangorda Mine	No data for Whistle Mine or AMAX piles	Vangorda Mine	
V	SMWMP		SMWMP	No S correlation	Whistle Mine		Vangorda Mine	
Zn	SMWMP		AMAX Pile pH 6 to 8		Whistle Mine	Comparable to AMAX	Whistle Mine	No Cd, Pb, and Zn mineralization

G:\PolyMet Mining\1UP005.01\_Northmet\_project\_2004\Water\_Quality\_Predictions\Waste\_Rock\2010-12\_Scale-Up\_Factor\_Discussion\Modelling\_Approach\{ModelApproachByParameter\_1UP005001\_SJD\_REV00.xlsx  
 ]

## 4 Conclusions

The proposed method for calculating source water quality is based on the separation of contaminant release and leaching processes.

Release rates would be estimated from the parameters indicating weathering of source minerals which are mainly predicted to be sulfides, olivine and bioite, and the contaminant content of the minerals as evaluated using rock analyses and data obtained under acidic conditions from humidity cells.

Leaching processes depend on the solubility of secondary minerals most of which are not pure forms. As a result, leaching would be characterized using the SMWMP experiment designed to understand contaminant solubility, and analog data. The latter include the AMAX stockpiles, data from the Whistle Mine, near Sudbury, Ontario and Vangorda Mine, near Faro, Yukon Territory. For some contaminants, leaching would be evaluated using thermodynamic calculations.

Uncertainty in the calculations would be based on the distributions shown by the individual datasets.

**Attachments**

**Attachment 1**  
**Relationships Between Total Sulfur and Other**  
**Elements Determined by Aqua Regia**

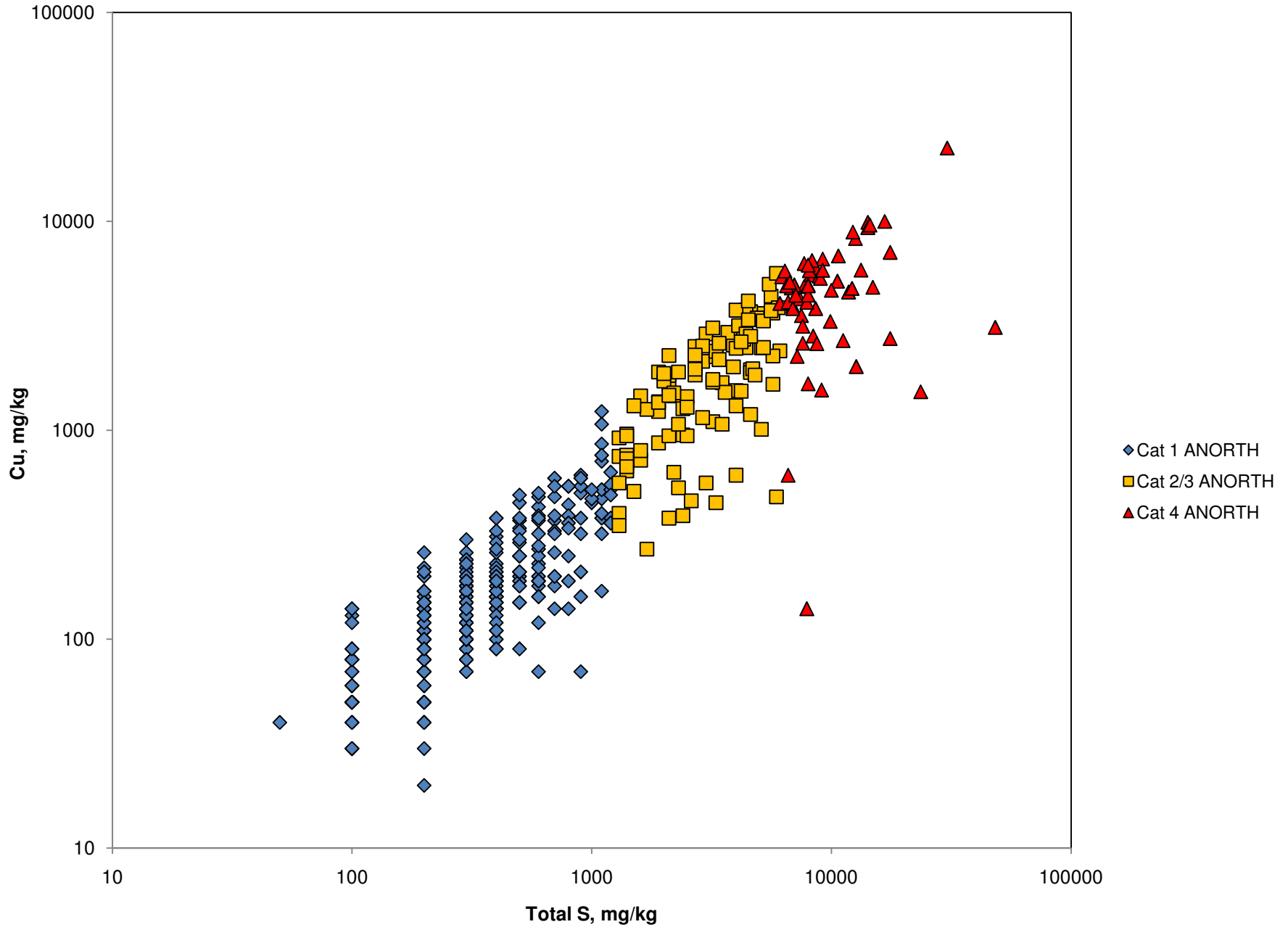

\\Van-svr0.van.na.srk.ad\ge\_projects\PolyMet Mining\1UP005.01\_Northmet\_project\_2004\Water\_Quality\_Predictions\Waste\_Rock\2011-02\_Collected\_Inputs\_for\_Modeling\Ratios\_In\_Solids\{ARMetalRatios\_1UP005001\_SJD\_VER00.xls}



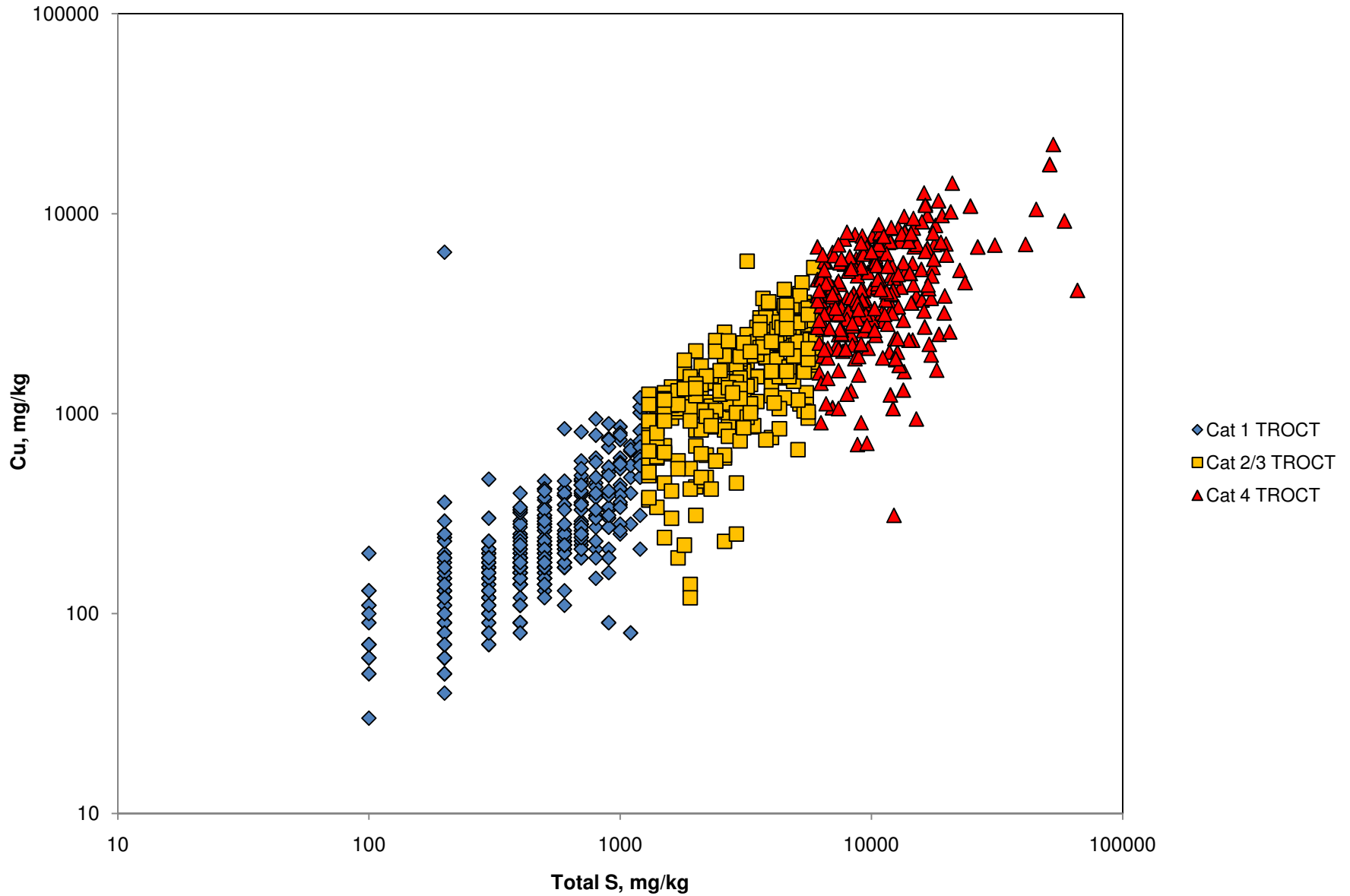

\\Wan-svr0.van.na.srk.ad\ge\_projects\PolyMet Mining\1UP005.01\_Northmet\_project\_2004\Water\_Quality\_Predictions\Waste\_Rock\2011-02\_Collected\_Inputs\_for\_Modeling\Ratios\_In\_Solids[ARMetalRatios\_1UP005001\_SJD\_VER00.xls]

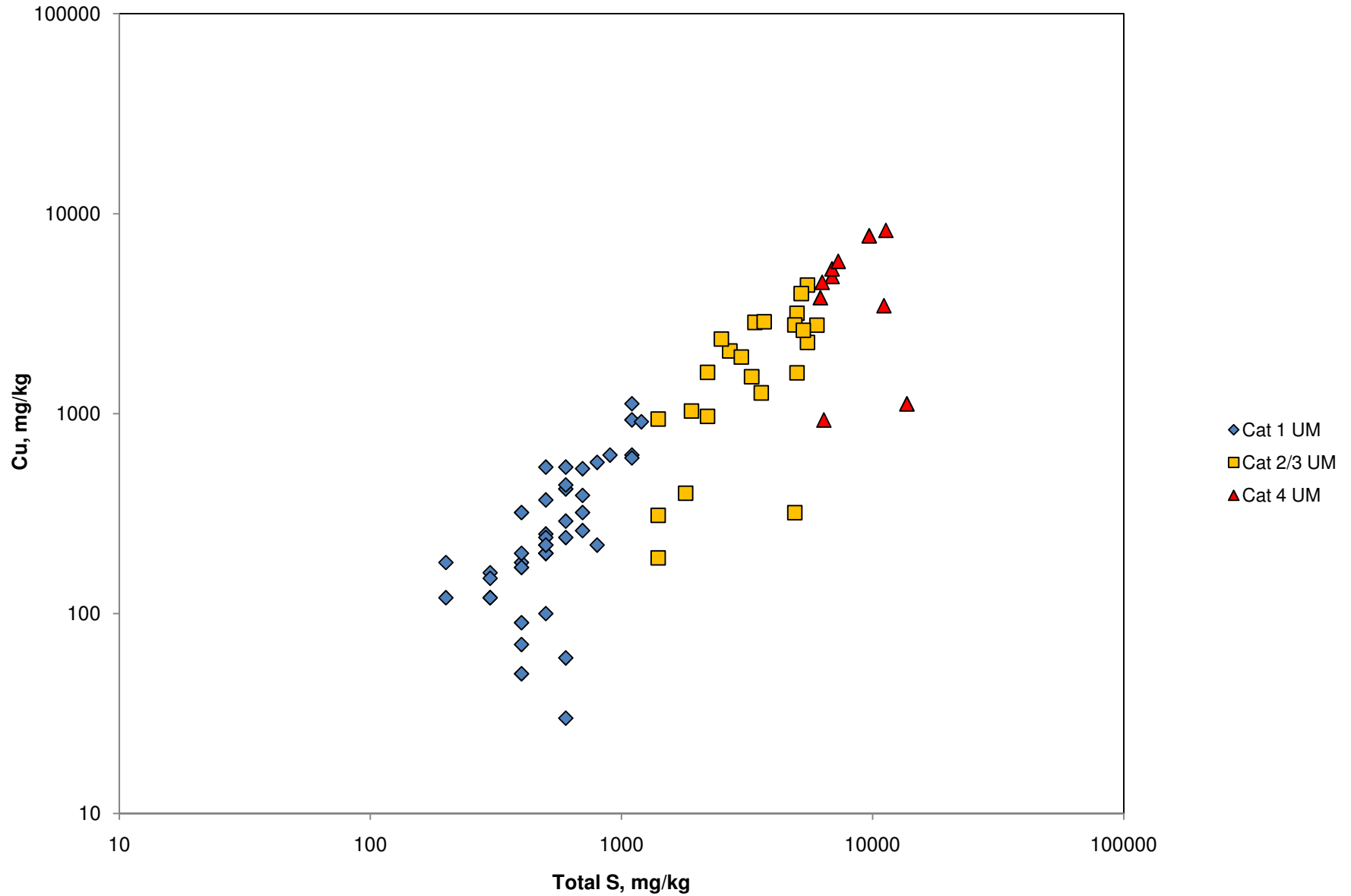

\\Van-svr0.van.na.srk.ad\ge\_projects\PolyMet Mining\1UP005.01\_Northmet\_project\_2004\Water\_Quality\_Predictions\Waste\_Rock\2011-02\_Collected\_Inputs\_for\_Modeling\Ratios\_In\_Solids[ARMetalRatios\_1UP005001\_SJD\_VER00.xls]

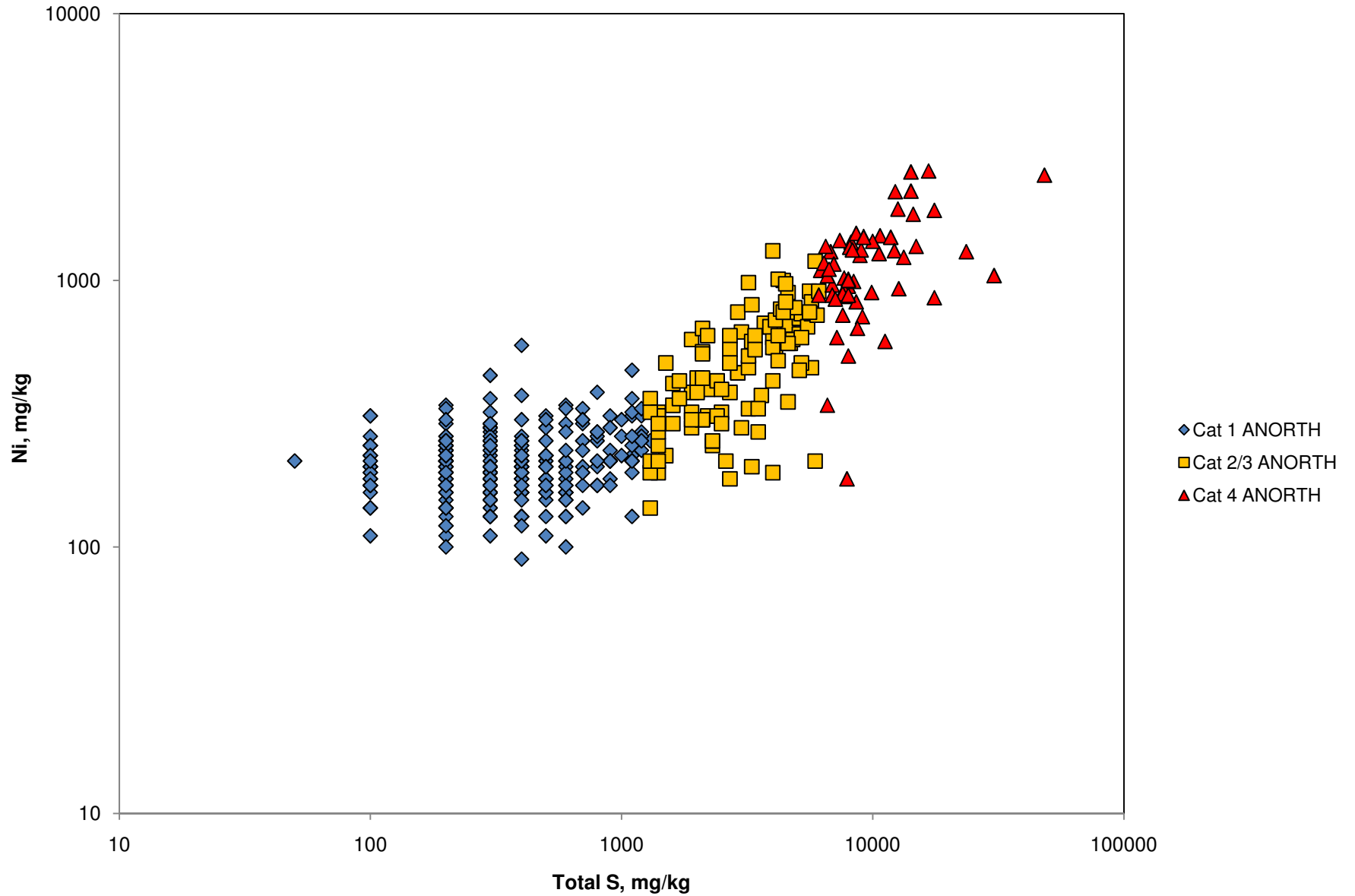

\\Van-svr0.van.na.srk.ad\ge\_projects\PolyMet Mining\1UP005.01\_Northmet\_project\_2004\Water\_Quality\_Predictions\Waste\_Rock\2011-02\_Collected\_Inputs\_for\_Modeling\Ratios\_In\_Solids[ARMetalRatios\_1UP005001\_SJD\_VER00.xls]

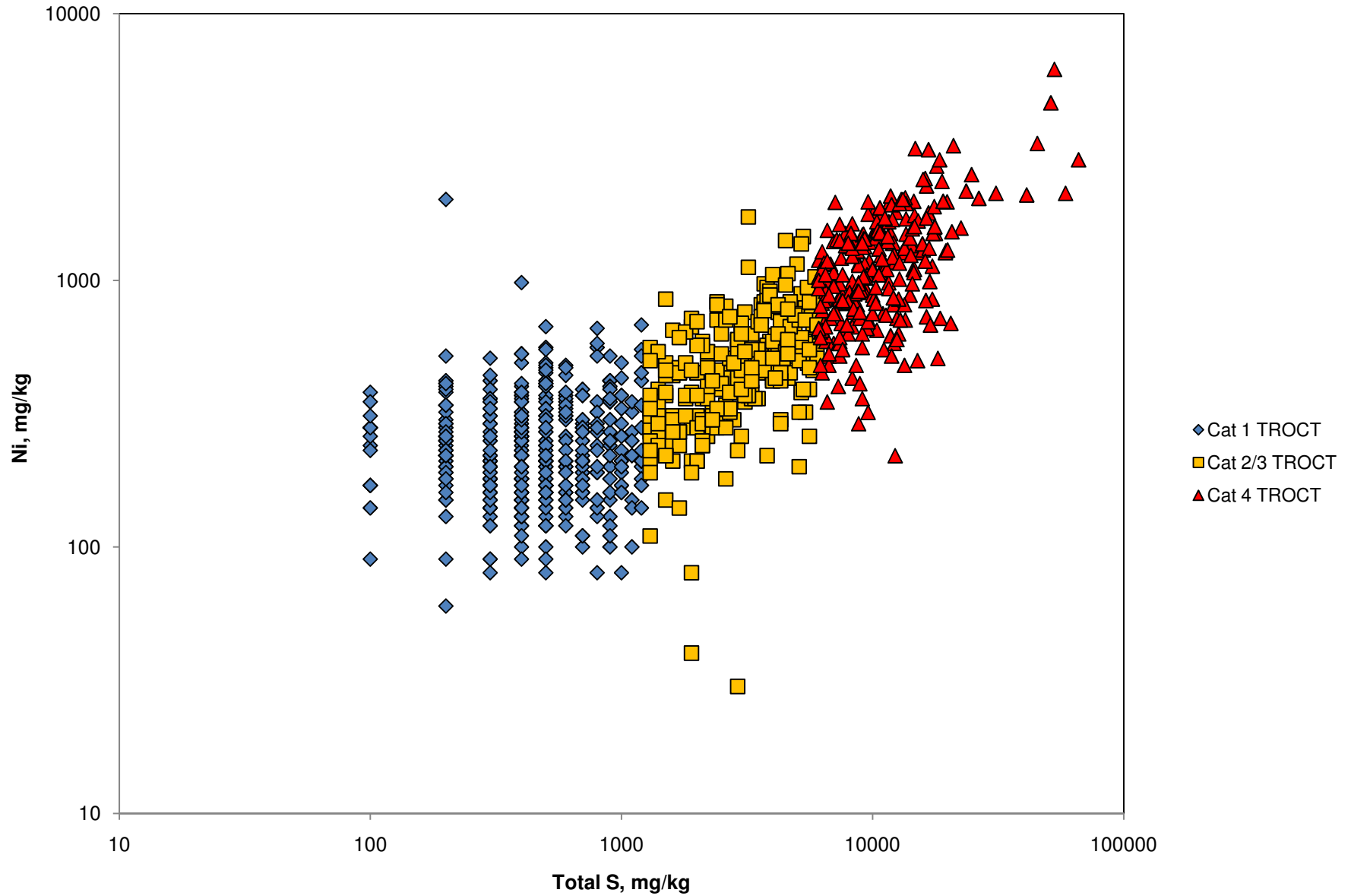

\\Van-svr0.van.na.srk.ad\ge\_projects\PolyMet Mining\1UP005.01\_Northmet\_project\_2004\Water\_Quality\_Predictions\Waste\_Rock\2011-02\_Collected\_Inputs\_for\_Modeling\Ratios\_In\_Solids[ARMetalRatios\_1UP005001\_SJD\_VER00.xls]

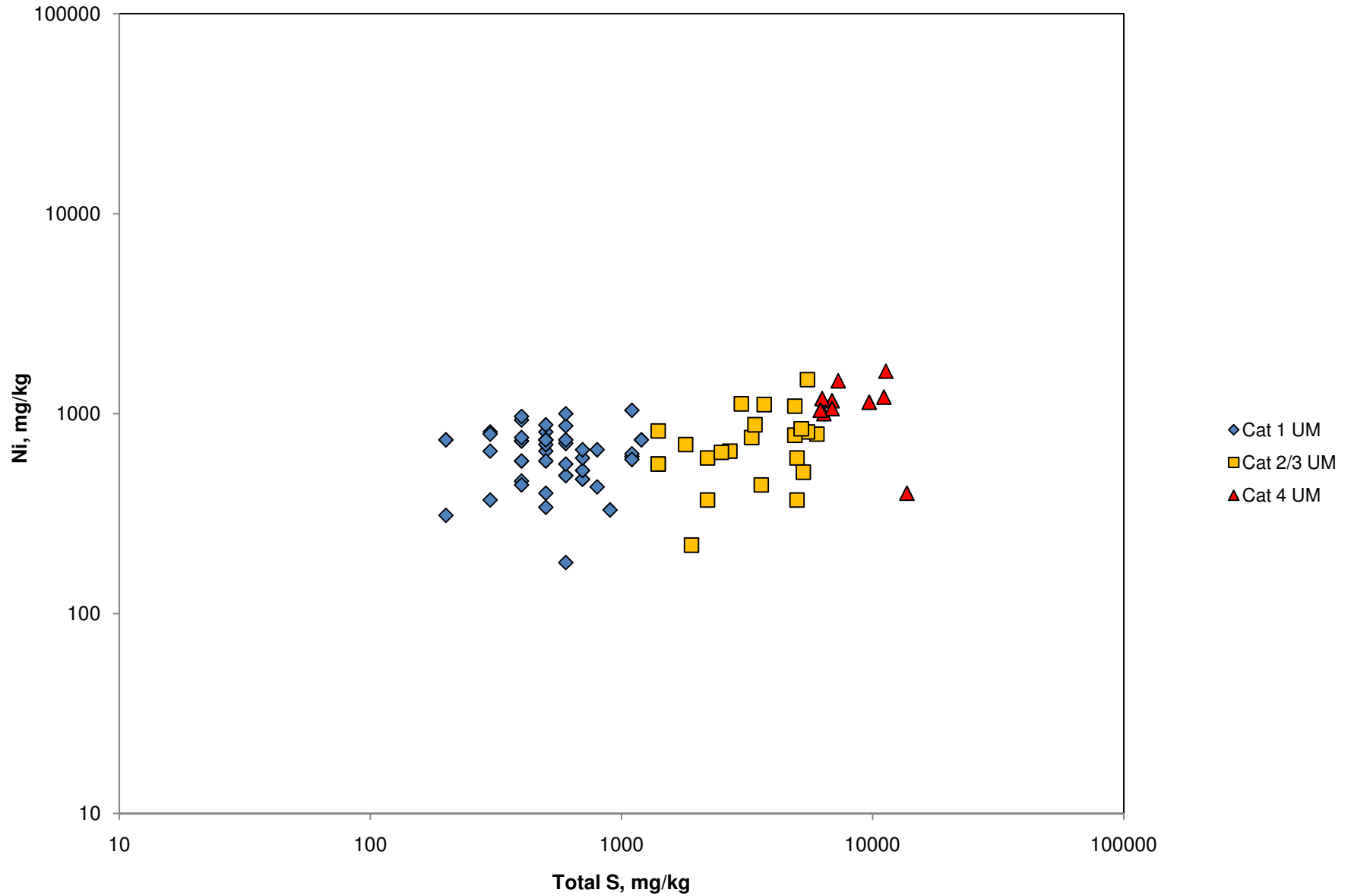

\\Van-svr0.van.na.srk.ad\ge\_projects\PolyMet Mining\1UP005.01\_Northmet\_project\_2004\Water\_Quality\_Predictions\Waste\_Rock\2011-02\_Collected\_Inputs\_for\_Modeling\Ratios\_In\_Solids[ARMetalRatios\_1UP005001\_SJD\_VER00.xls]

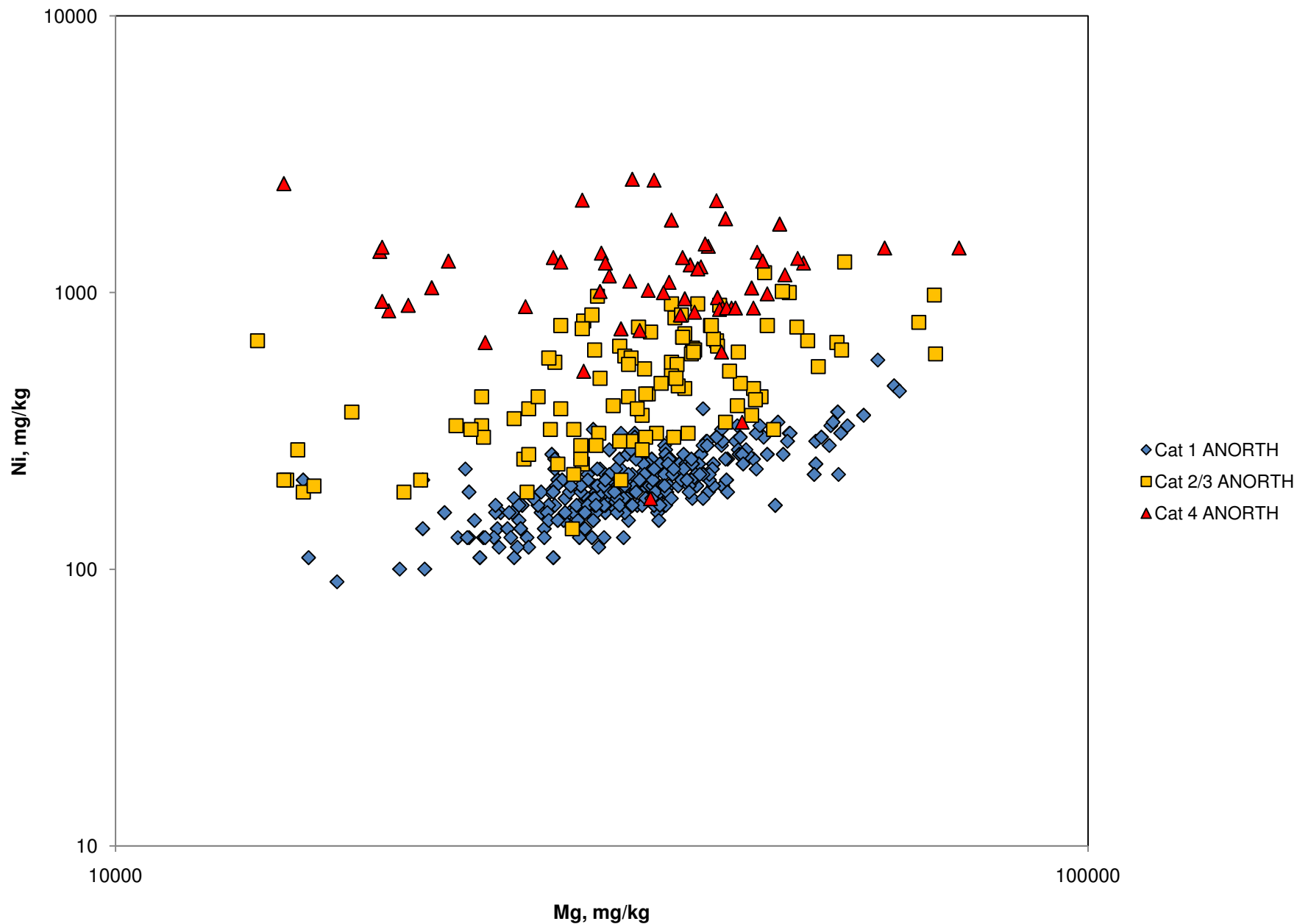

\\Van-svr0.van.na.srk.ad\ge\_projects\PolyMet Mining\1UP005.01\_Northmet\_project\_2004\Water\_Quality\_Predictions\Waste\_Rock\2011-02\_Collected\_Inputs\_for\_Modeling\Ratios\_In\_Solids[ARMetalRatios\_1UP005001\_SJD\_VER00.xls]

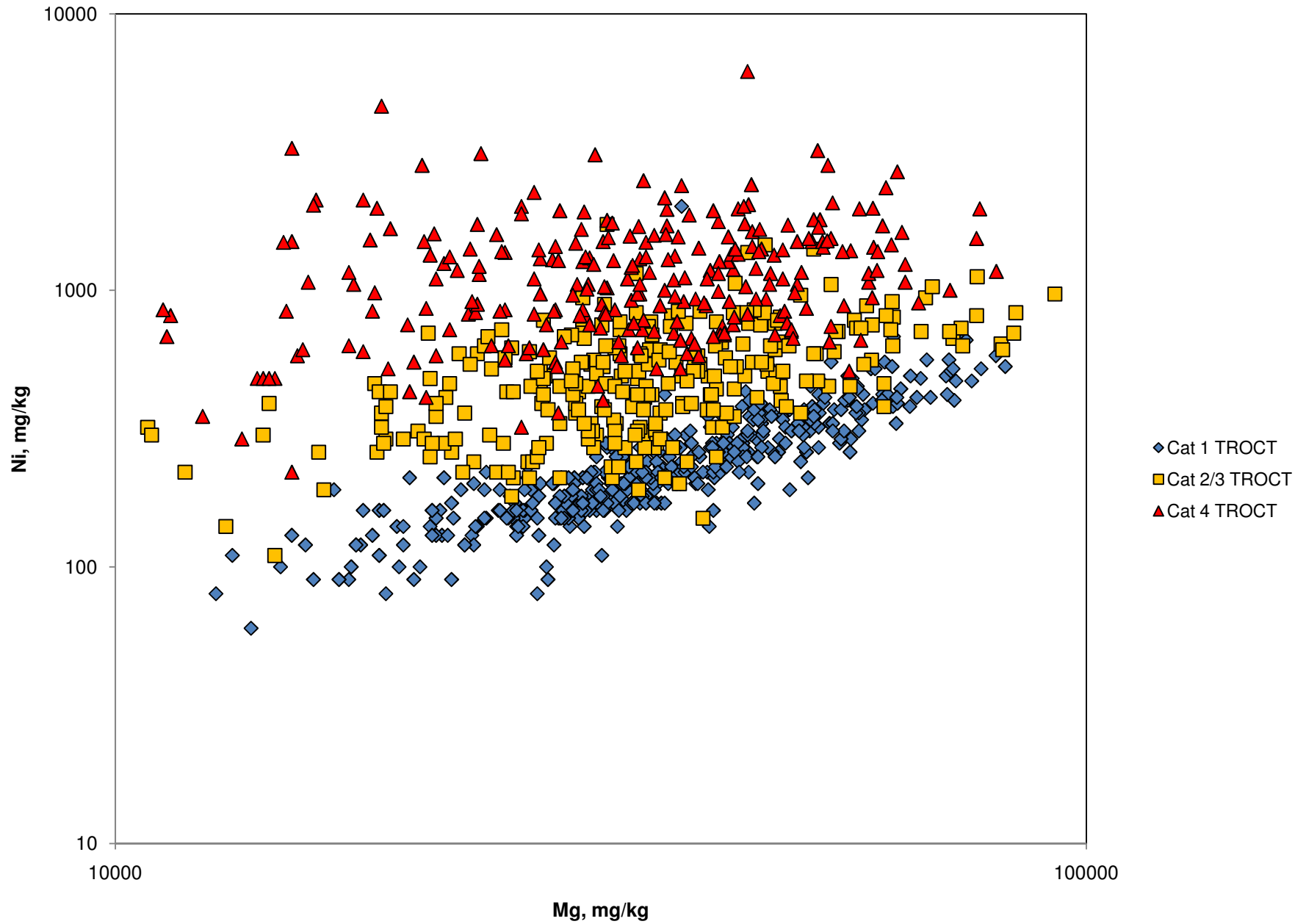

\\Van-svr0.van.na.srk.ad\ge\_projects\PolyMet Mining\1UP005.01\_Northmet\_project\_2004\Water\_Quality\_Predictions\Waste\_Rock\2011-02\_Collected\_Inputs\_for\_Modeling\Ratios\_In\_Solids[ARMetalRatios\_1UP005001\_SJD\_VER00.xls]

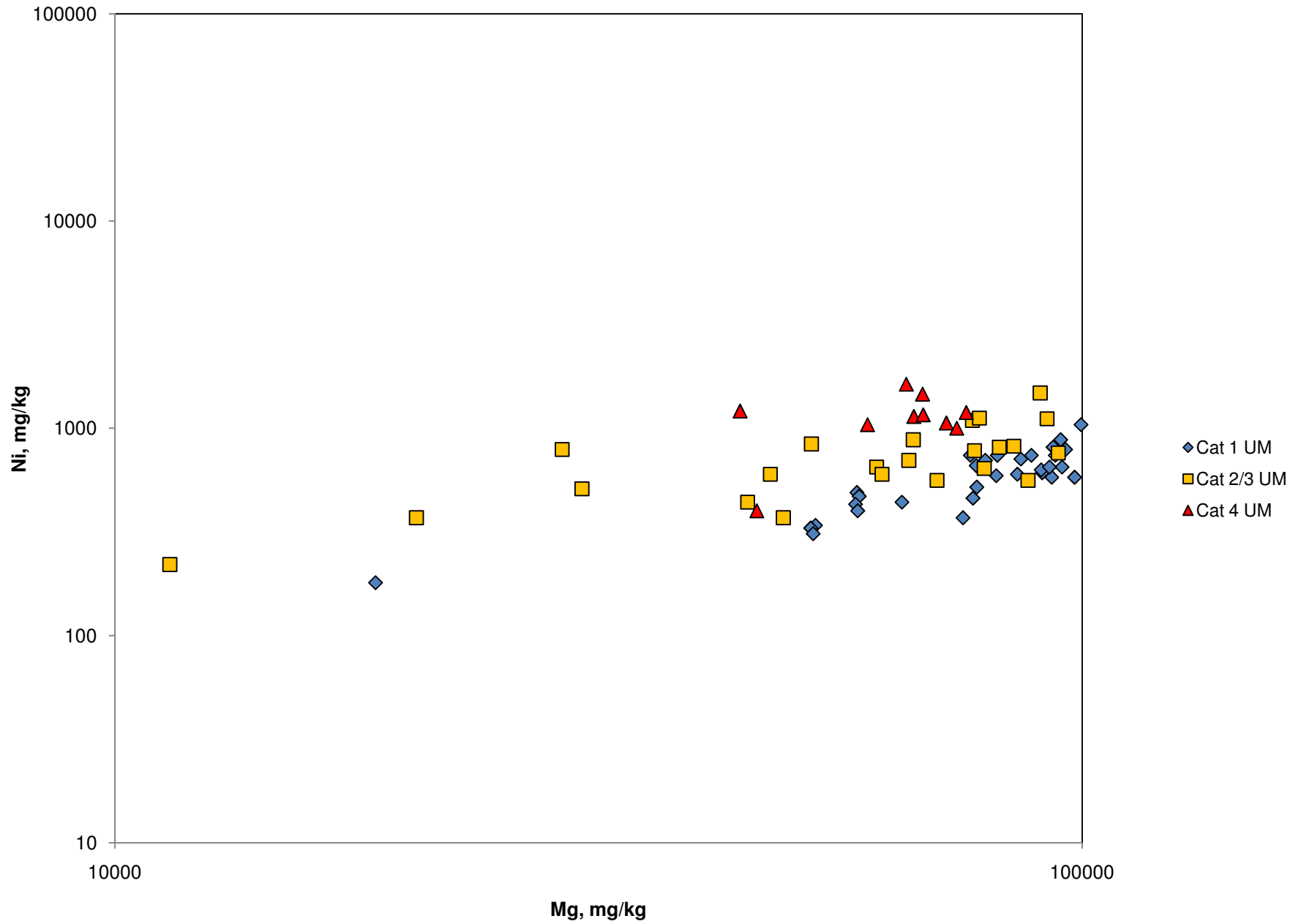

\\Wan-svr0.van.na.srk.ad\ge\_projects\PolyMet Mining\1UP005.01\_Northmet\_project\_2004\Water\_Quality\_Predictions\Waste\_Rock\2011-02\_Collected\_Inputs\_for\_Modeling\Ratios\_In\_Solids\ARMetalRatios\_1UP005001\_SJD\_VER00.xls]



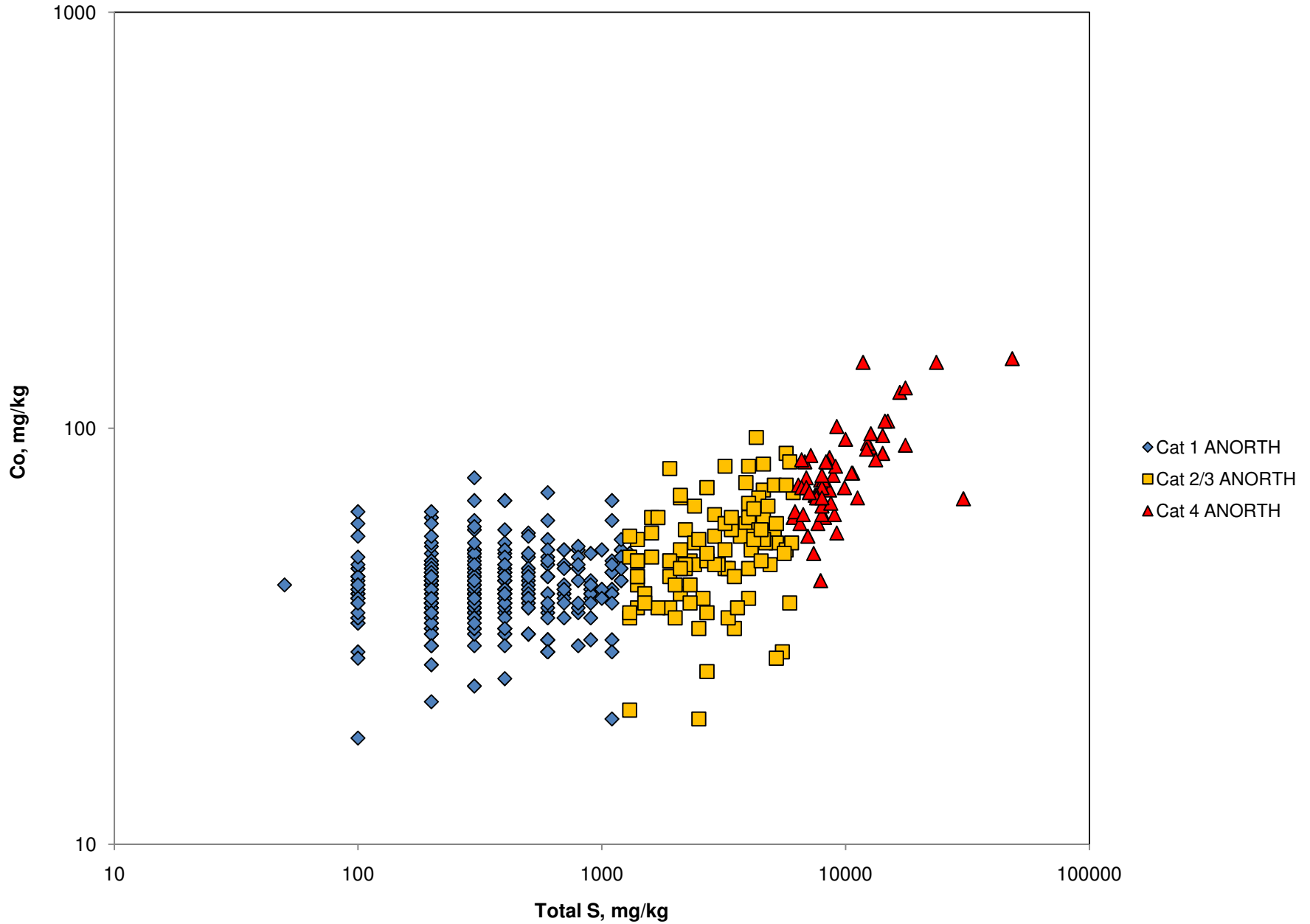

\\Van-svr0.van.na.srk.ad\ge\_projects\PolyMet Mining\1UP005.01\_Northmet\_project\_2004\Water\_Quality\_Predictions\Waste\_Rock\2011-02\_Collected\_Inputs\_for\_Modeling\Ratios\_In\_Solids[ARMetalRatios\_1UP005001\_SJD\_VER00.xls]

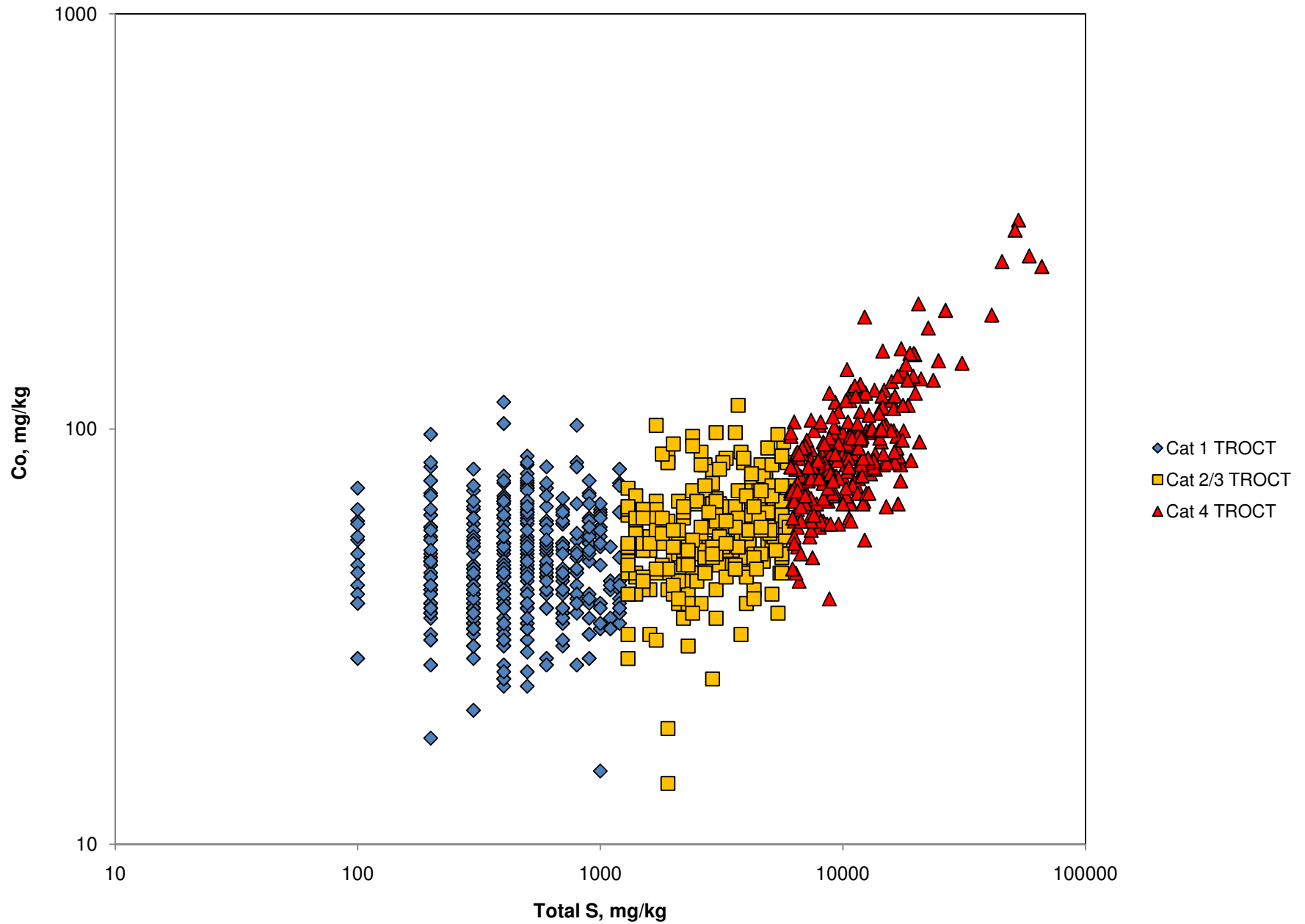

\\Van-svr0.van.na.srk.ad\ge\_projects\PolyMet Mining\1UP005.01\_Northmet\_project\_2004\Water\_Quality\_Predictions\Waste\_Rock\2011-02\_Collected\_Inputs\_for\_Modeling\Ratios\_In\_Solids[ARMetalRatios\_1UP005001\_SJD\_VER00.xls]

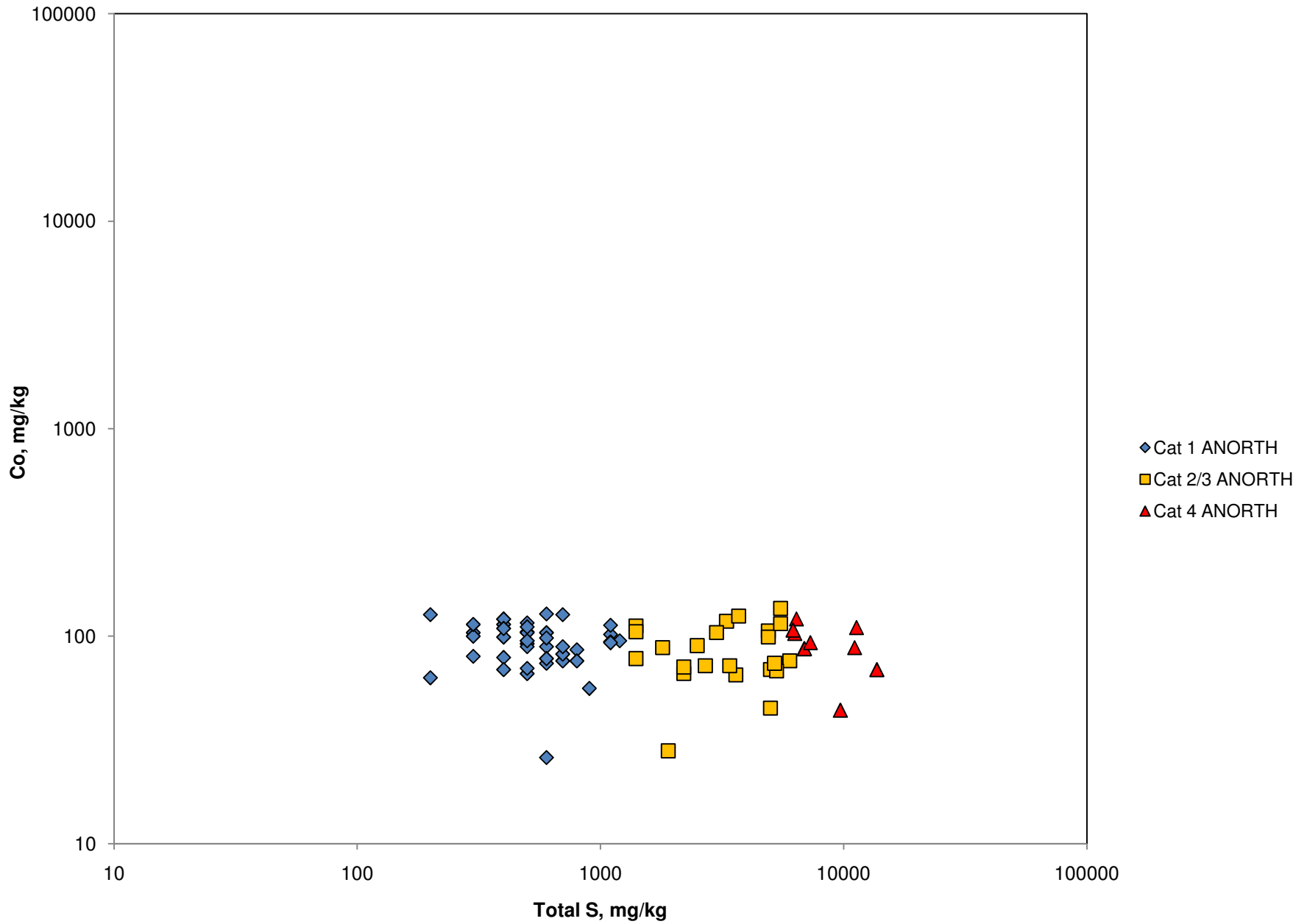

\\Van-svr0.van.na.srk.ad\ge\_projects\PolyMet Mining\1UP005.01\_Northmet\_project\_2004\Water\_Quality\_Predictions\Waste\_Rock\2011-02\_Collected\_Inputs\_for\_Modeling\Ratios\_In\_Solids[ARMetalRatios\_1UP005001\_SJD\_VER00.xls]

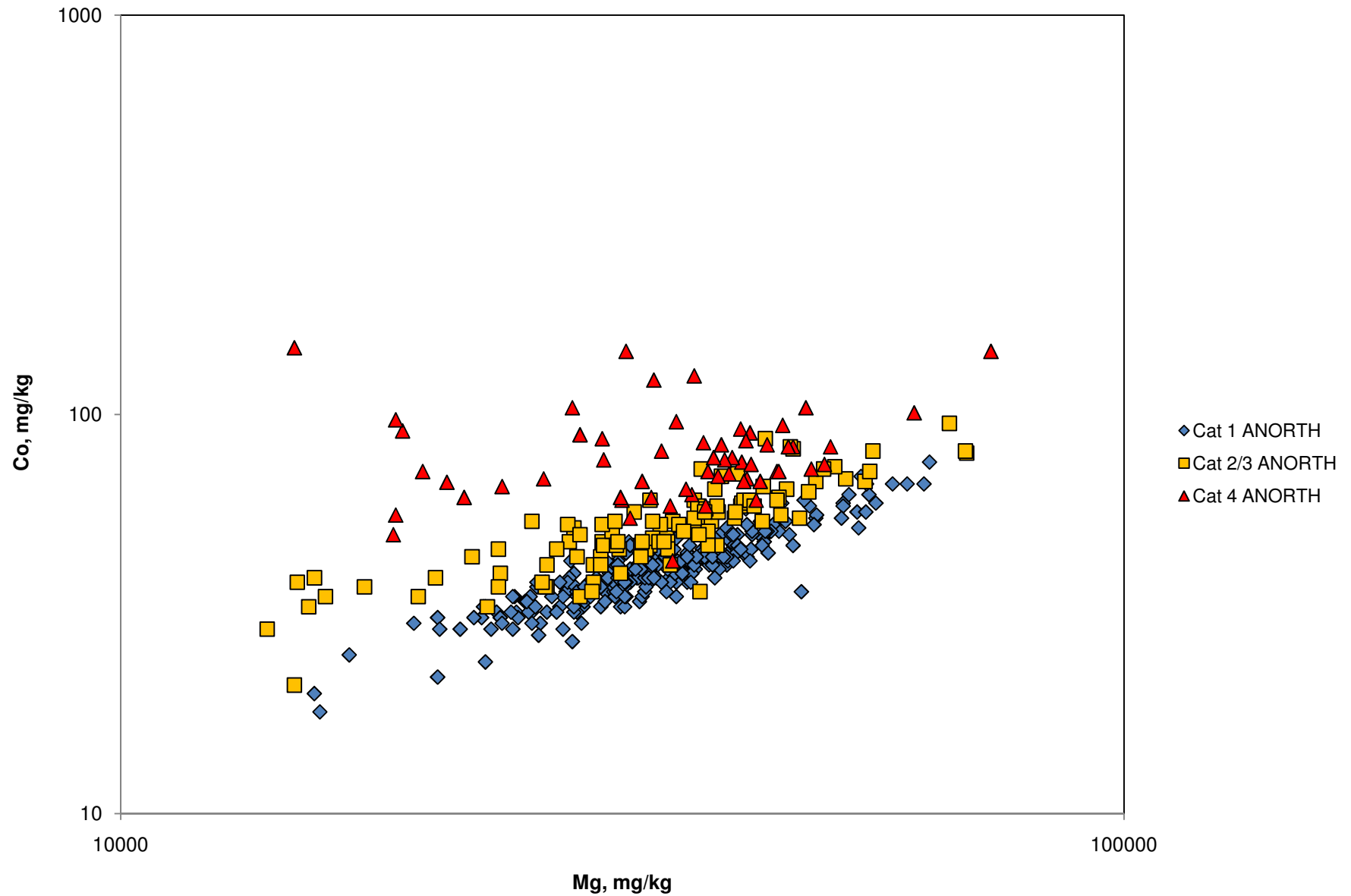

\\Wan-svr0.van.na.srk.ad\ge\_projects\PolyMet Mining\1UP005.01\_Northmet\_project\_2004\Water\_Quality\_Predictions\Waste\_Rock\2011-02\_Collected\_Inputs\_for\_Modeling\Ratios\_In\_Solids\ARMetalRatios\_1UP005001\_SJD\_VER00.xls

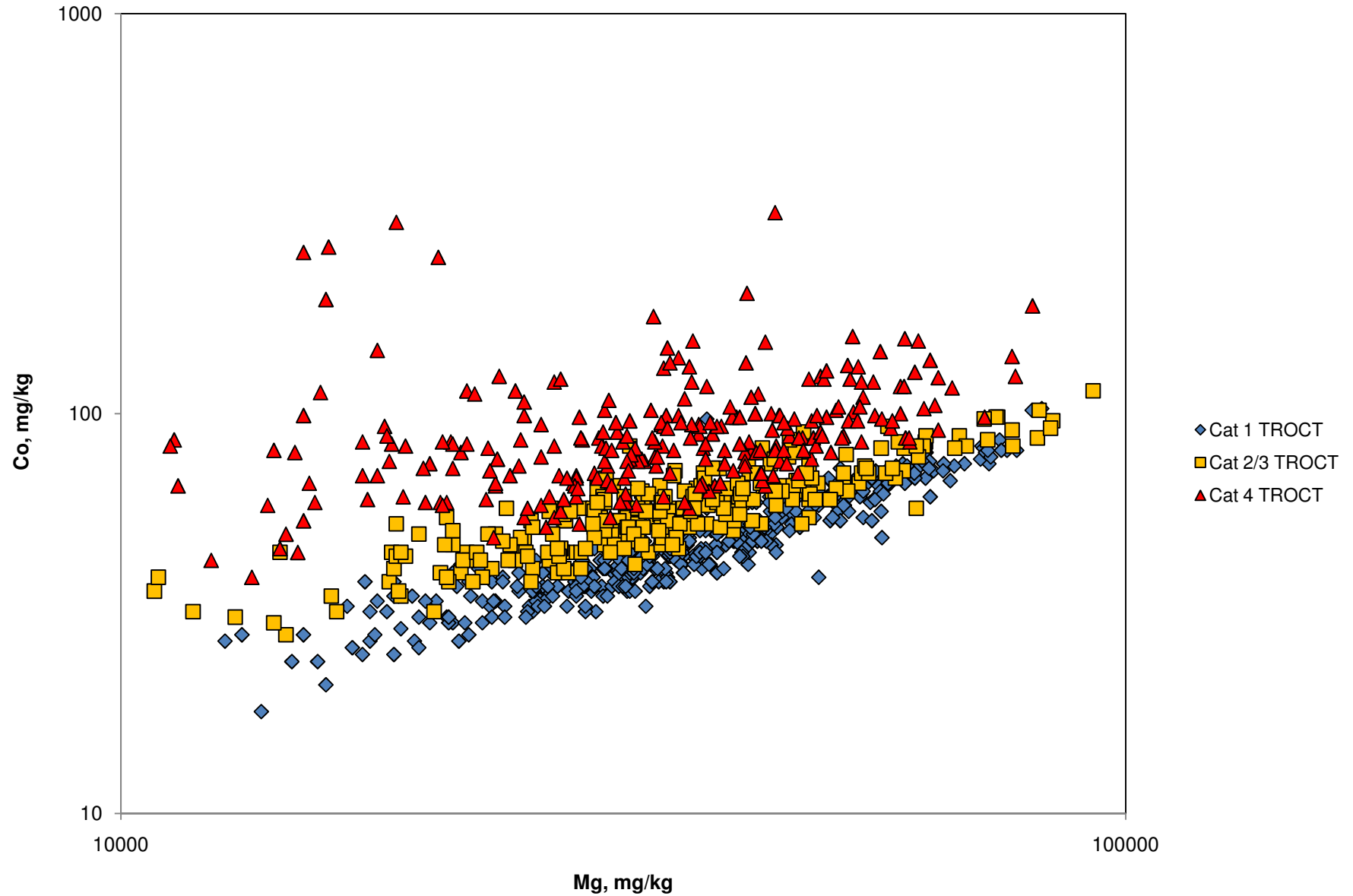

\\Van-svr0.van.na.srk.ad\ge\_projects\PolyMet Mining\1UP005.01\_Northmet\_project\_2004\Water\_Quality\_Predictions\Waste\_Rock\2011-02\_Collected\_Inputs\_for\_Modeling\Ratios\_In\_Solids\{ARMetalRatios\_1UP005001\_SJD\_VER00.xls}

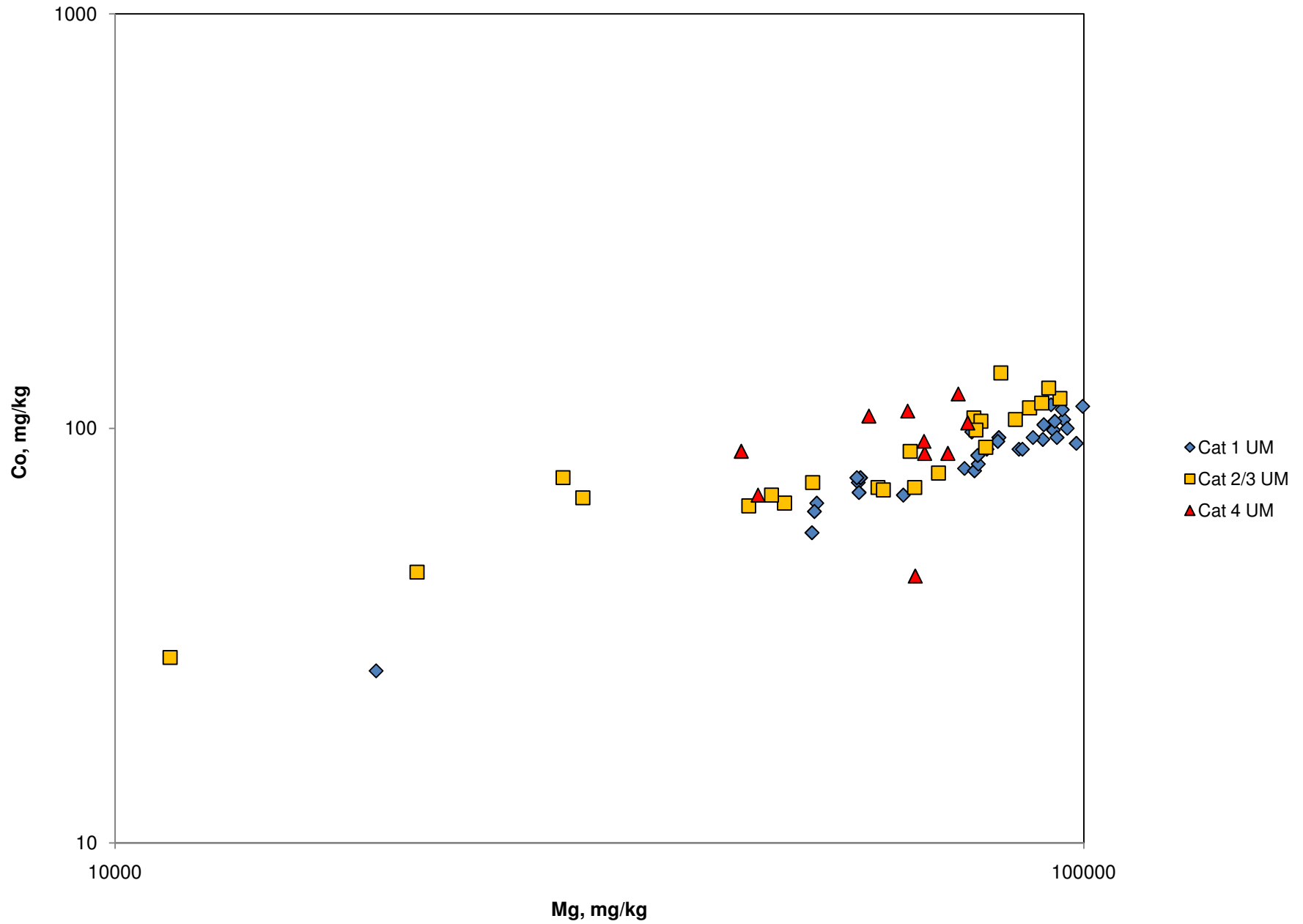

\\Van-svr0.van.na.srk.ad\ge\_projects\PolyMet Mining\1UP005.01\_Northmet\_project\_2004\Water\_Quality\_Predictions\Waste\_Rock\2011-02\_Collected\_Inputs\_for\_Modeling\Ratios\_In\_Solids[ARMetalRatios\_1UP005001\_SJD\_VER00.xls]

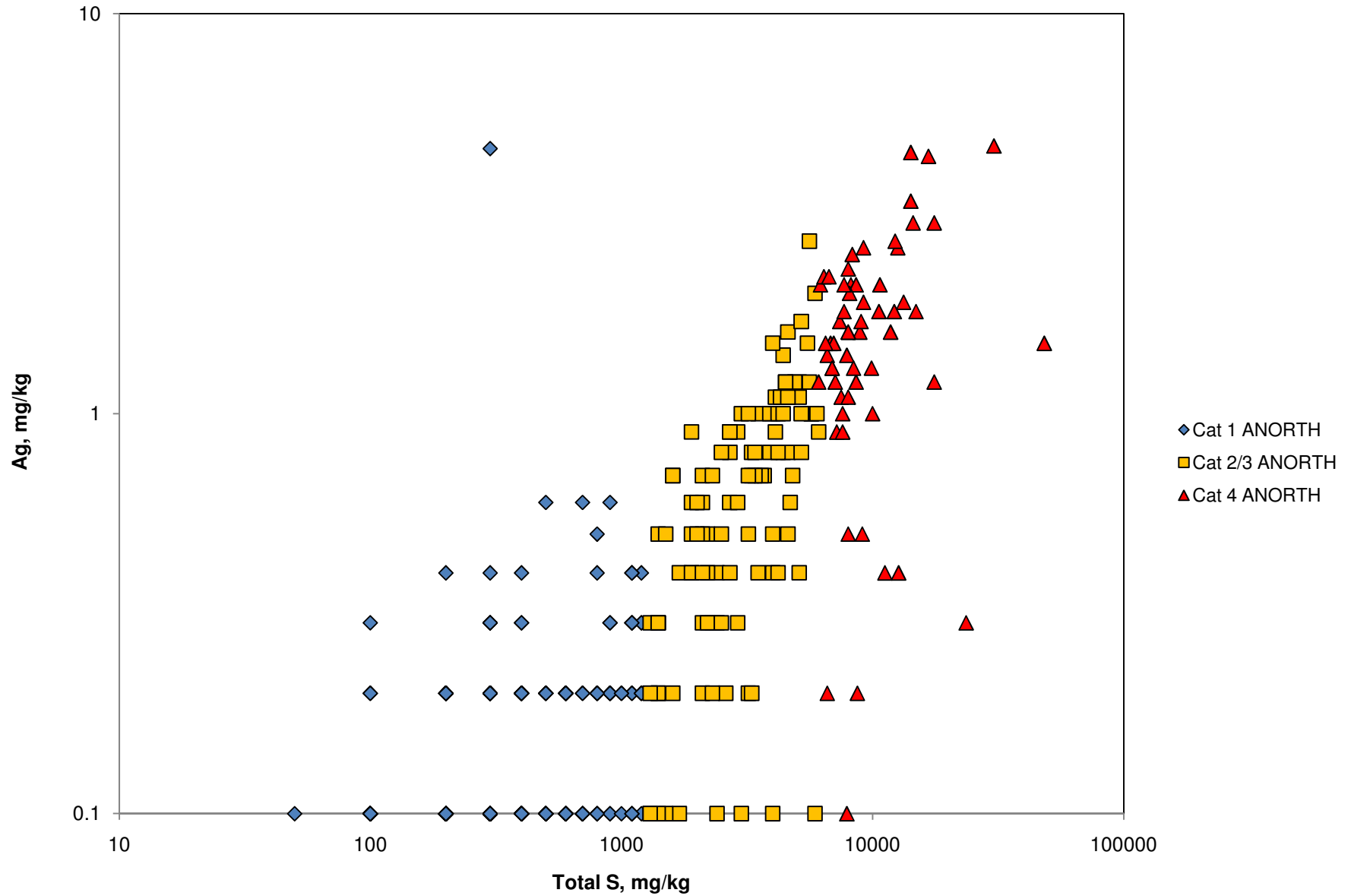

\\Wan-svr0.van.na.srk.ad\ge\_projects\PolyMet Mining\1UP005.01\_Northmet\_project\_2004\Water\_Quality\_Predictions\Waste\_Rock\2011-02\_Collected\_Inputs\_for\_Modeling\Ratios\_In\_Solids[ARMetalRatios\_1UP005001\_SJD\_VER00.xls]

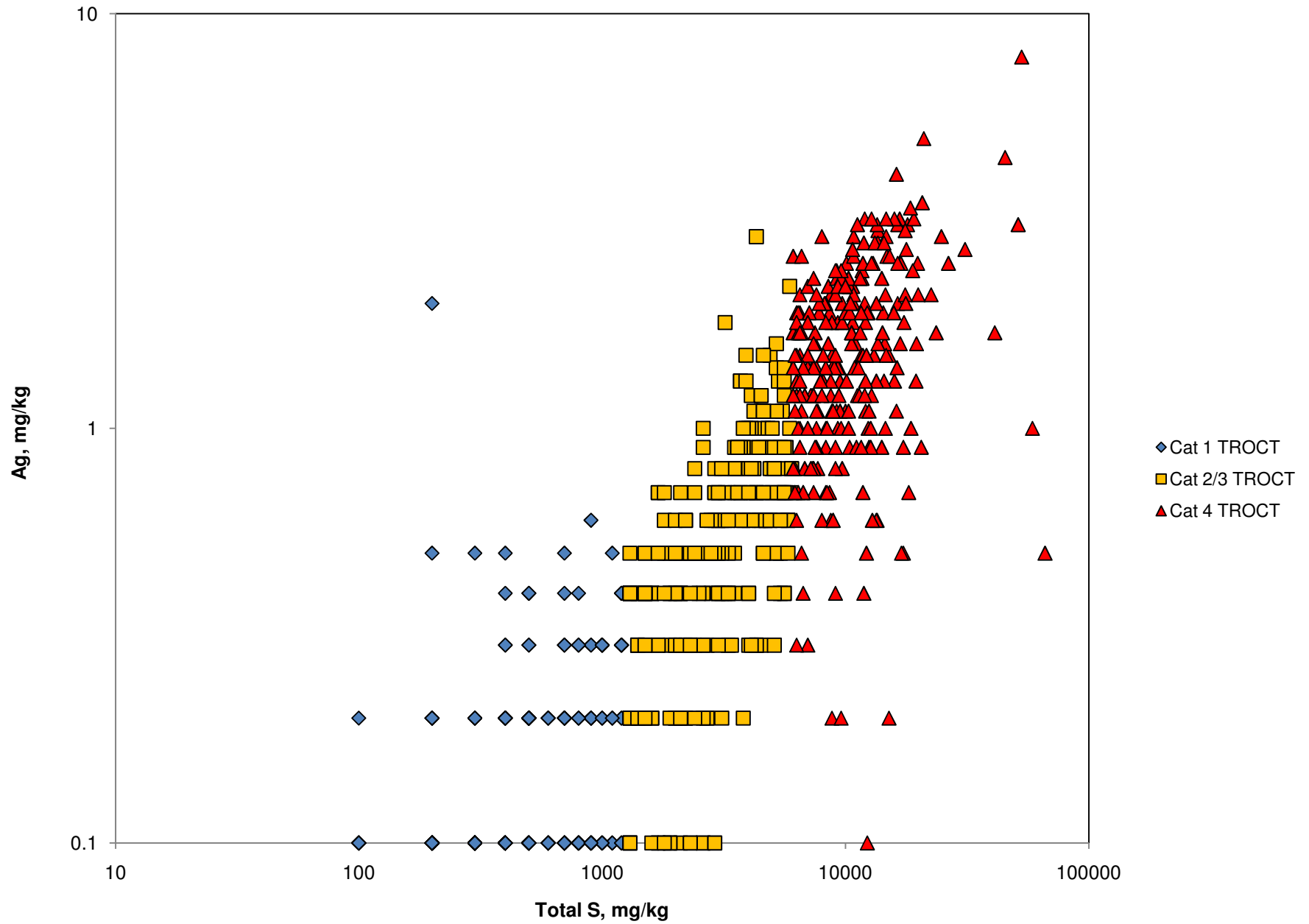

\\Wan-svr0.van.na.srk.ad\ge\_projects\PolyMet Mining\1UP005.01\_Northmet\_project\_2004\Water\_Quality\_Predictions\Waste\_Rock\2011-02\_Collected\_Inputs\_for\_Modeling\Ratios\_In\_Solids[ARMetalRatios\_1UP005001\_SJD\_VER00.xls]



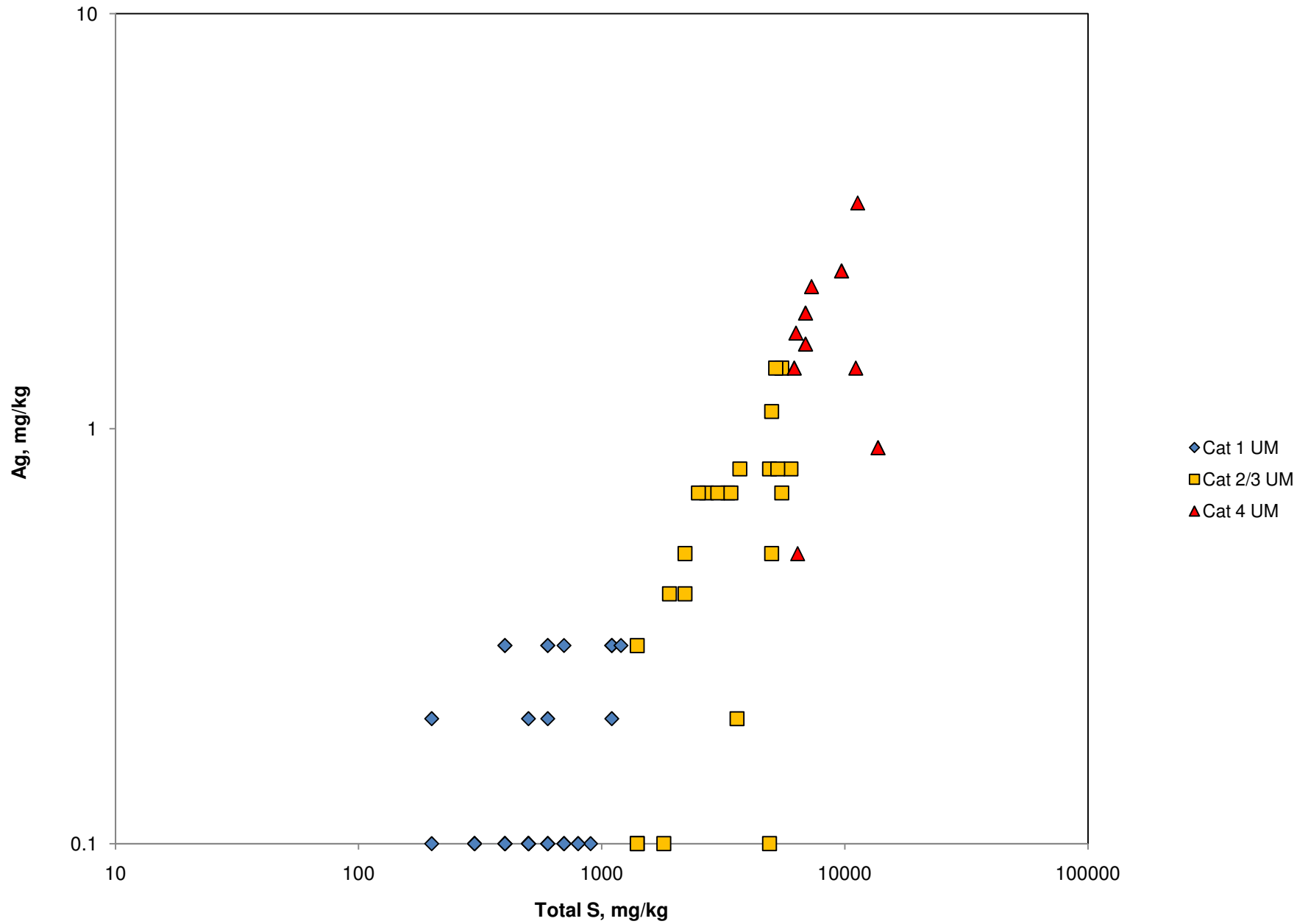

\\Van-svr0.van.na.srk.ad\ge\_projects\PolyMet Mining\1UP005.01\_Northmet\_project\_2004\Water\_Quality\_Predictions\Waste\_Rock\2011-02\_Collected\_Inputs\_for\_Modeling\Ratios\_In\_Solids[ARMetalRatios\_1UP005001\_SJD\_VER00.xls]

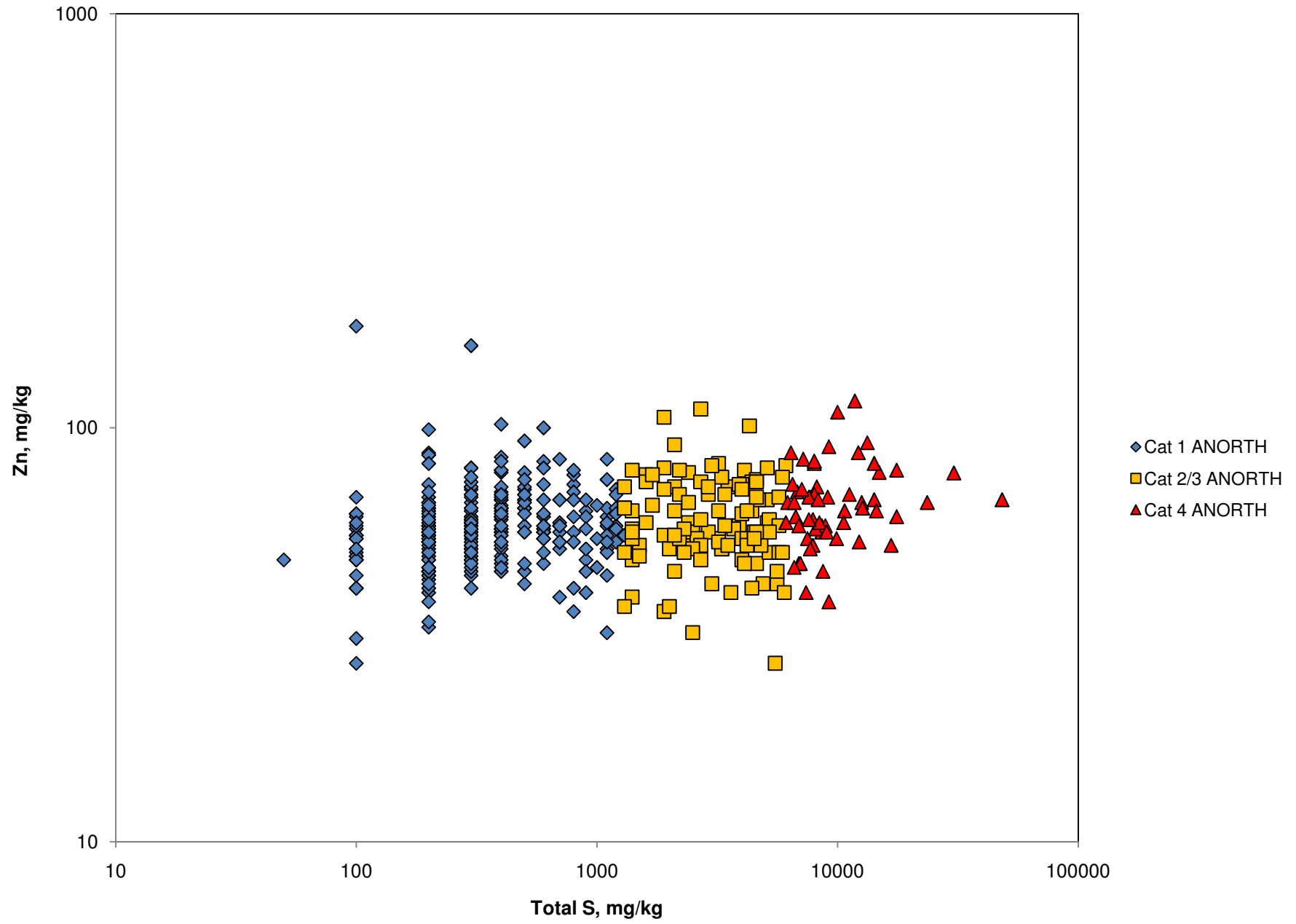

\\Van-svr0.van.na.srk.ad\ge\_projects\PolyMet Mining\1UP005.01\_Northmet\_project\_2004\Water\_Quality\_Predictions\Waste\_Rock\2011-02\_Collected\_Inputs\_for\_Modeling\Ratios\_In\_Solids\{ARMetalRatios\_1UP005001\_SJD\_VER00.xls}

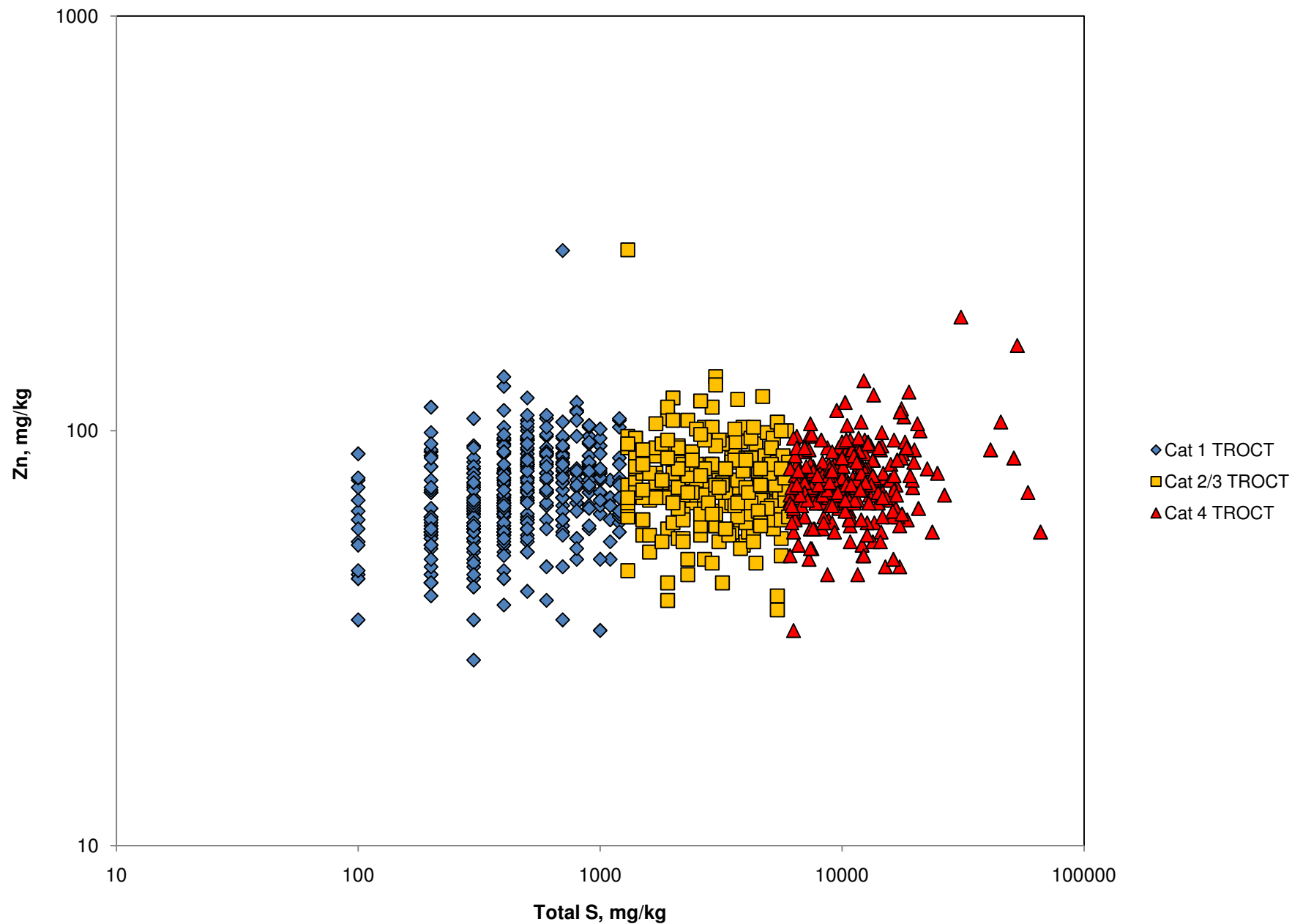

\\Van-svr0.van.na.srk.ad\ge\_projects\PolyMet Mining\1UP005.01\_Northmet\_project\_2004\Water\_Quality\_Predictions\Waste\_Rock\2011-02\_Collected\_Inputs\_for\_Modeling\Ratios\_In\_Solids[ARMetalRatios\_1UP005001\_SJD\_VER00.xls]

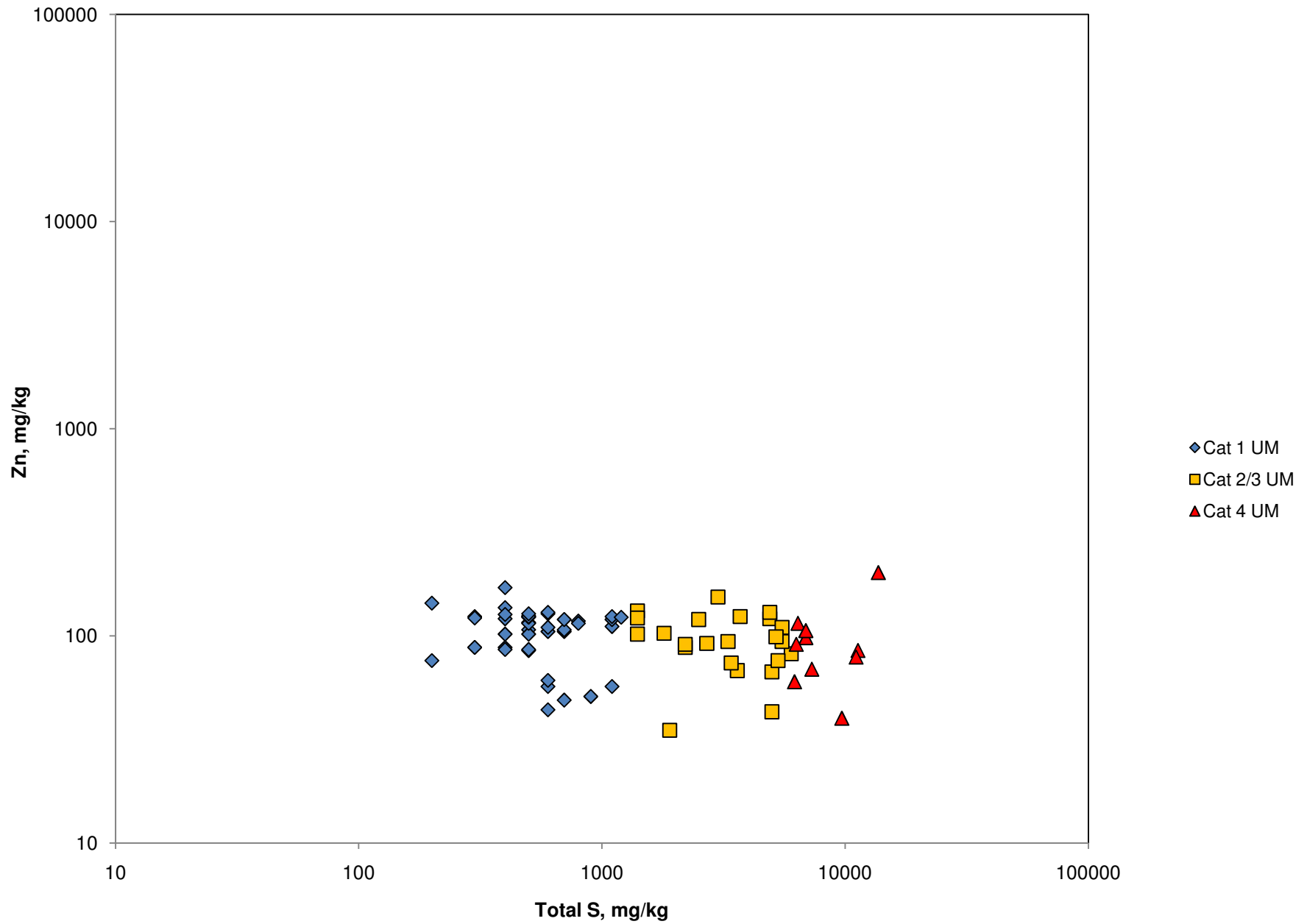

\\Wan-svr0.van.na.srk.ad\ge\_projects\PolyMet Mining\1UP005.01\_Northmet\_project\_2004\Water\_Quality\_Predictions\Waste\_Rock\2011-02\_Collected\_Inputs\_for\_Modeling\Ratios\_In\_Solids\ARMetalRatios\_1UP005001\_SJD\_VER00.xls

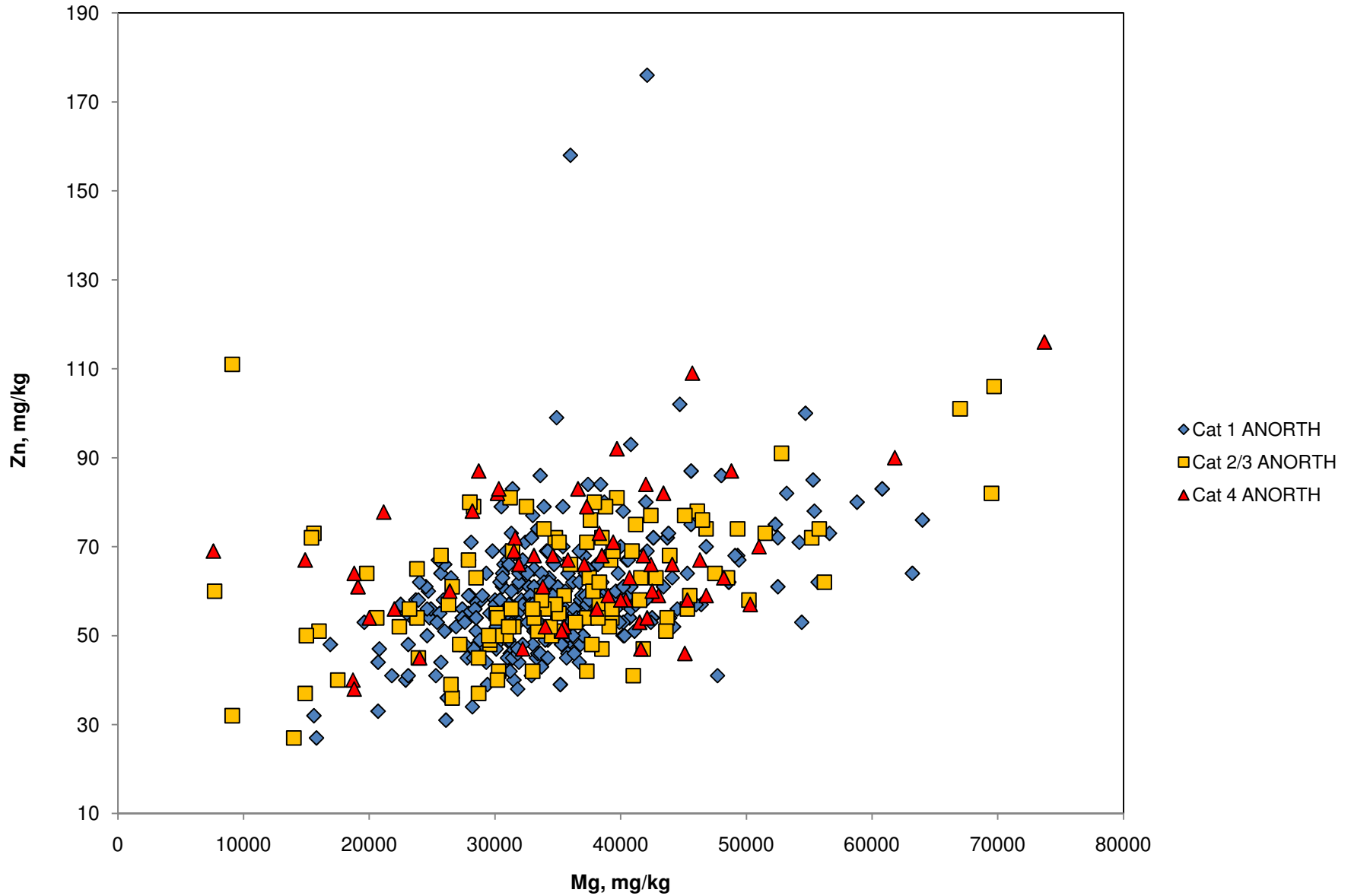

\\Wan-svr0.van.na.srk.ad\ge\_projects\PolyMet Mining\1UP005.01\_Northmet\_project\_2004\Water\_Quality\_Predictions\Waste\_Rock\2011-02\_Collected\_Inputs\_for\_Modeling\Ratios\_In\_Solids\ARMetalRatios\_1UP005001\_SJD\_VER00.xls

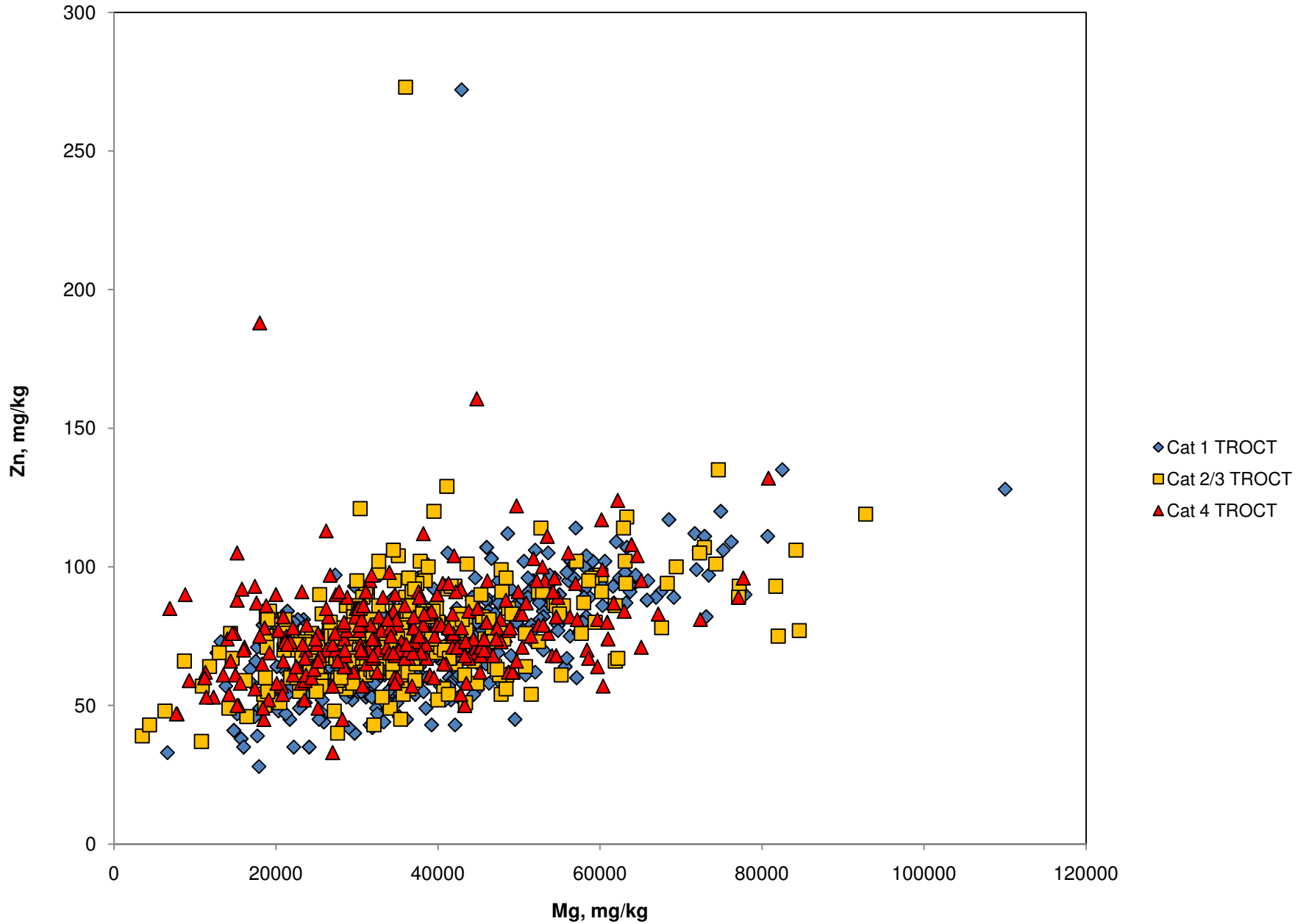

\\Van-svr0.van.na.srk.ad\ge\_projects\PolyMet Mining\1UP005.01\_Northmet\_project\_2004\Water\_Quality\_Predictions\Waste\_Rock\2011-02\_Collected\_Inputs\_for\_Modeling\Ratios\_In\_Solids[ARMetalRatios\_1UP005001\_SJD\_VER00.xls]

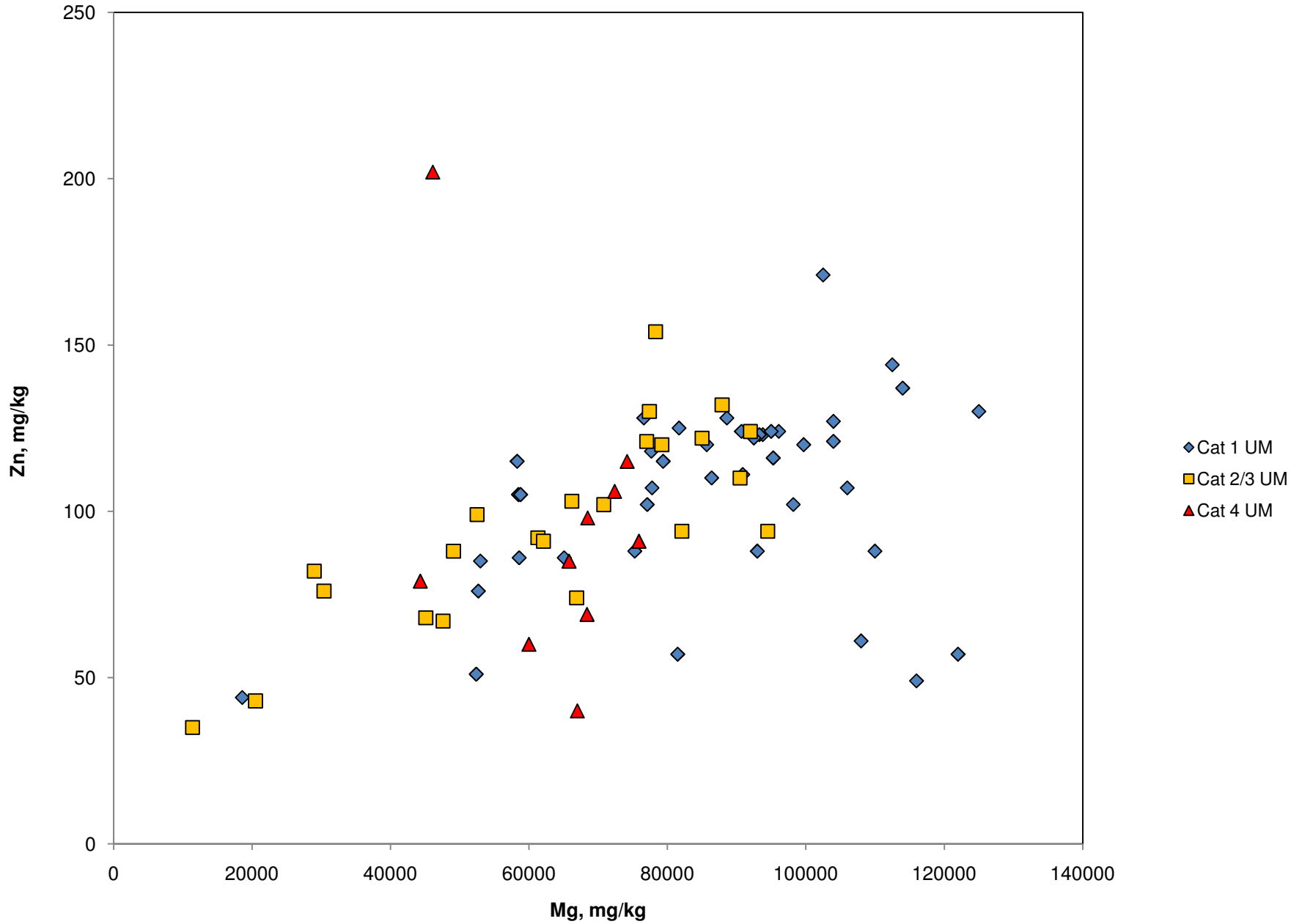

\\Van-svr0.van.na.srk.ad\ge\_projects\PolyMet Mining\1UP005.01\_Northmet\_project\_2004\Water\_Quality\_Predictions\Waste\_Rock\2011-02\_Collected\_Inputs\_for\_Modeling\Ratios\_In\_Solids\ARMetalRatios\_1UP005001\_SJD\_VER00.xls

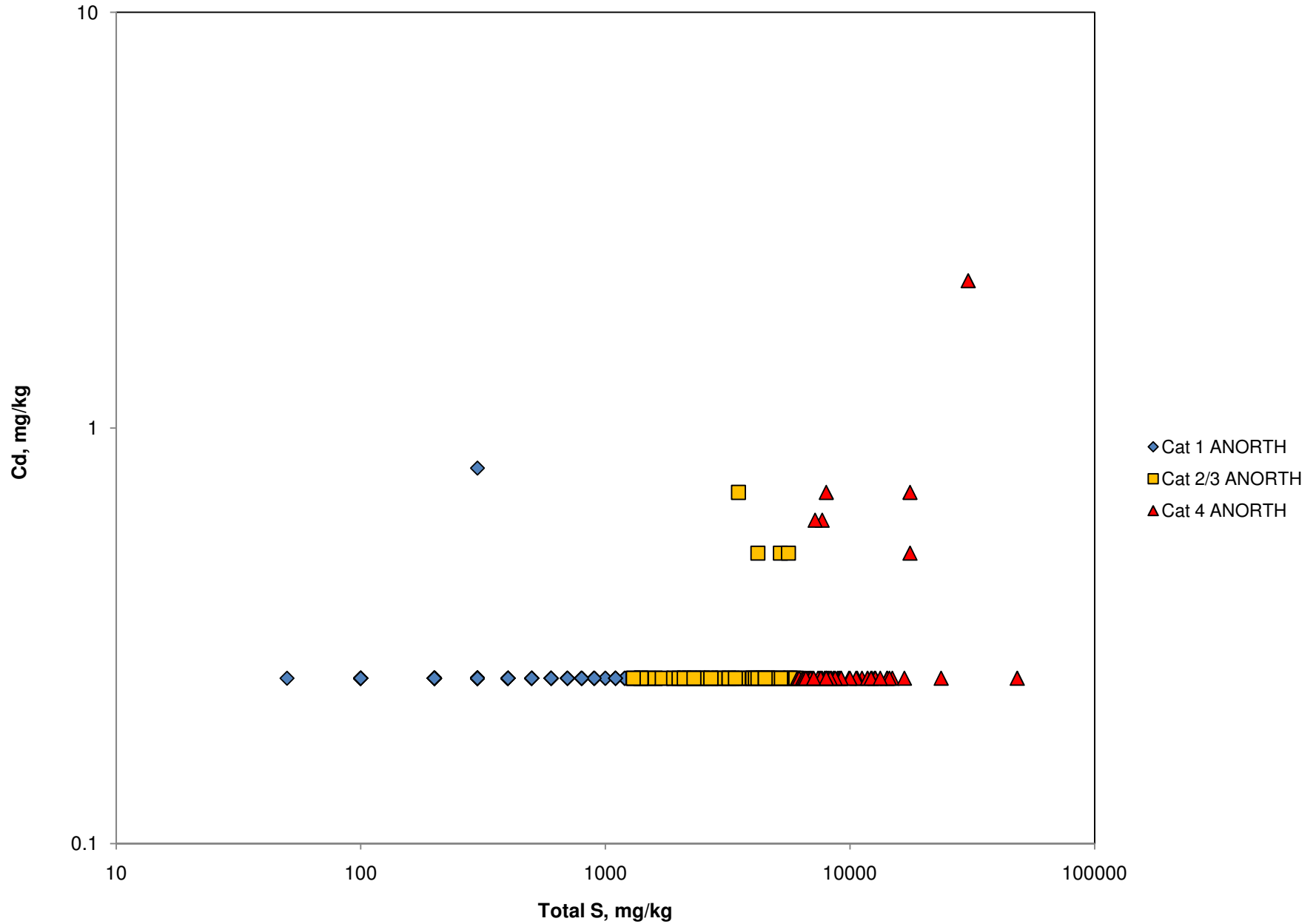

\\Van-svr0.van.na.srk.ad\ge\_projects\PolyMet Mining\1UP005.01\_Northmet\_project\_2004\Water\_Quality\_Predictions\Waste\_Rock\2011-02\_Collected\_Inputs\_for\_Modeling\Ratios\_In\_Solids\{ARMetalRatios\_1UP005001\_SJD\_VER00.xls}



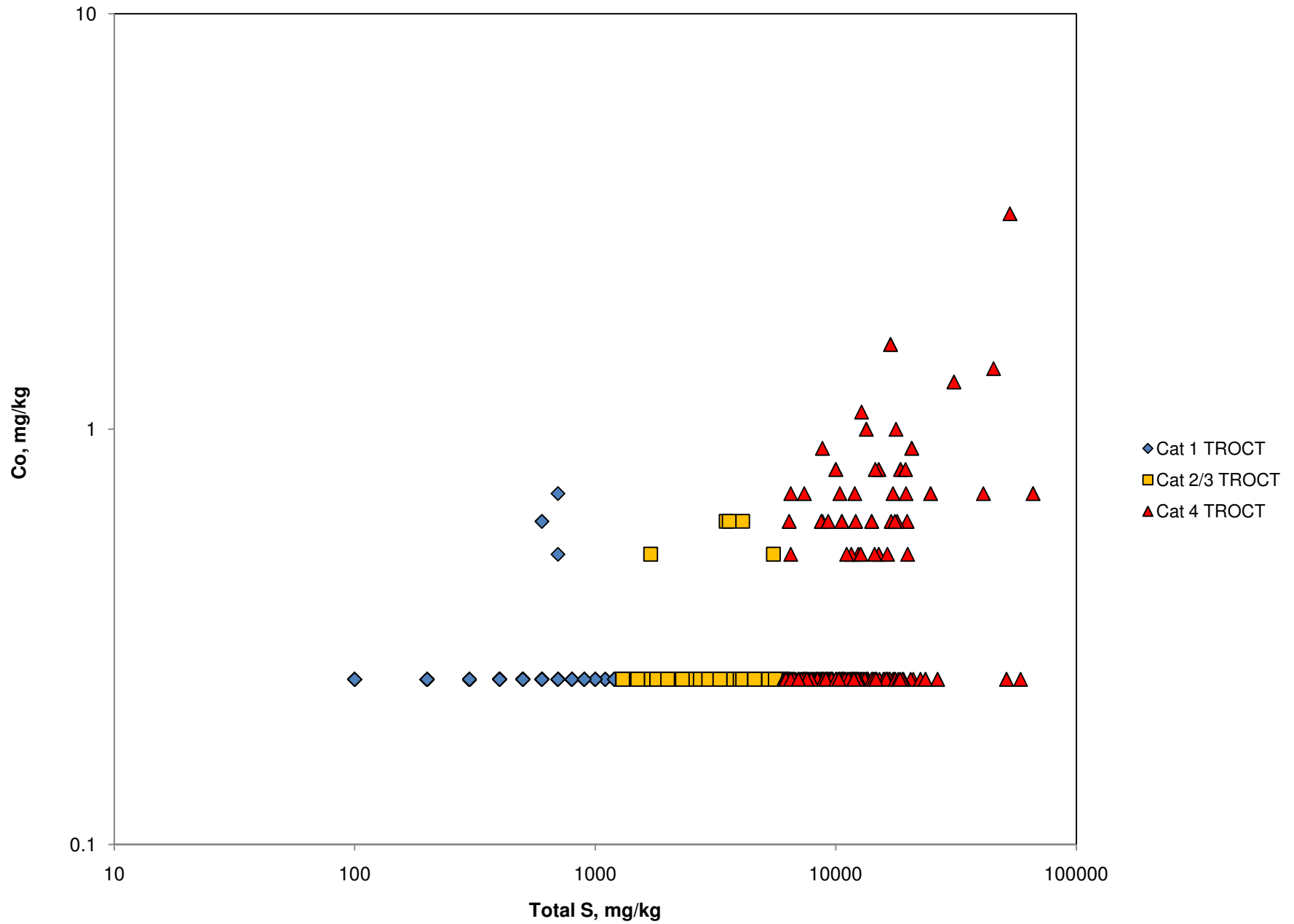

\\Van-svr0.van.na.srk.ad\ge\_projects\PolyMet Mining\1UP005.01\_Northmet\_project\_2004\Water\_Quality\_Predictions\Waste\_Rock\2011-02\_Collected\_Inputs\_for\_Modeling\Ratios\_In\_Solids[ARMetalRatios\_1UP005001\_SJD\_VER00.xls]

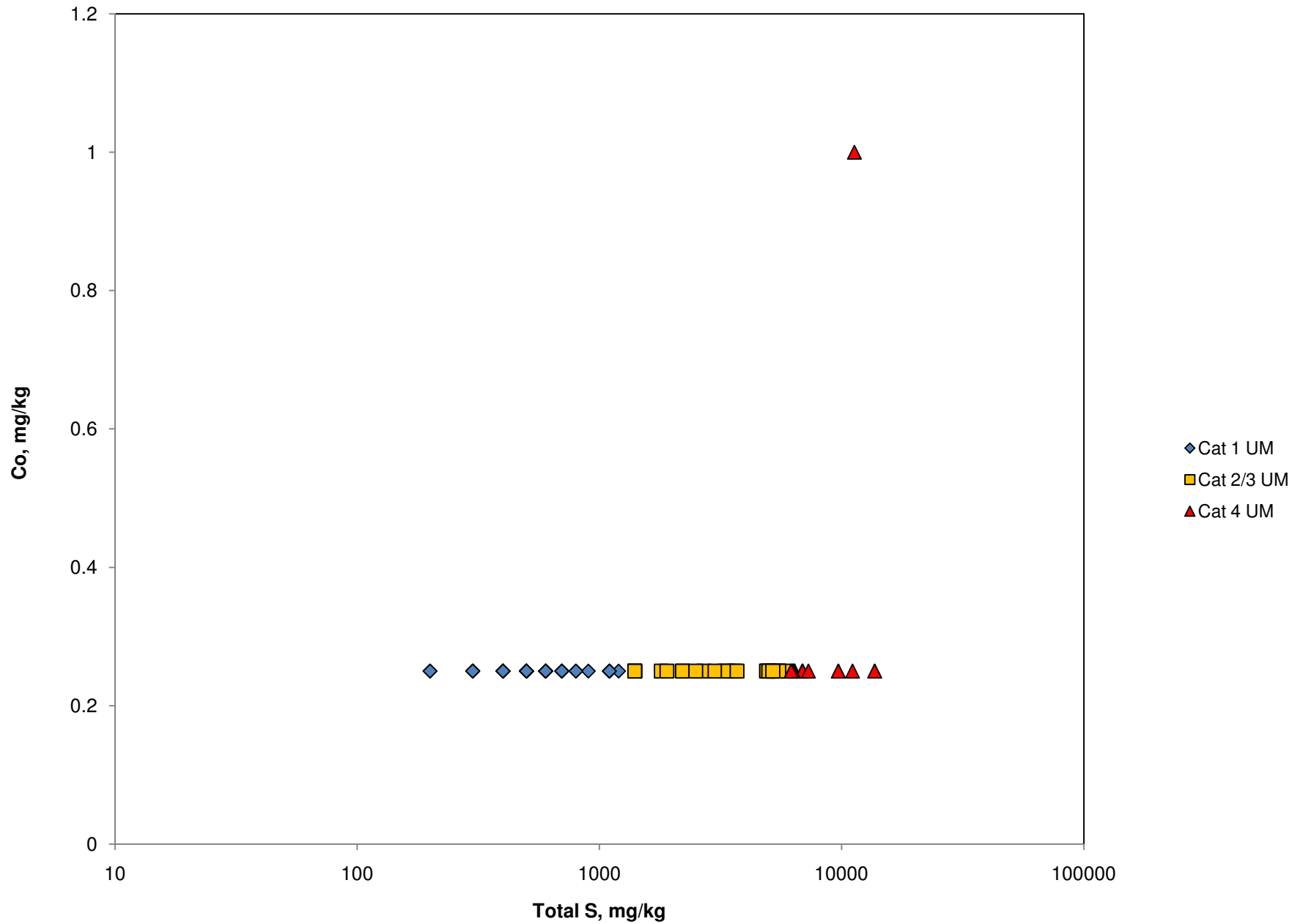

\\Van-svr0.van.na.srk.ad\ge\_projects\PolyMet Mining\1UP005.01\_Northmet\_project\_2004\Water\_Quality\_Predictions\Waste\_Rock\2011-02\_Collected\_Inputs\_for\_Modeling\Ratios\_In\_Solids\ARMetalRatios\_1UP005001\_SJD\_VER00.xls]

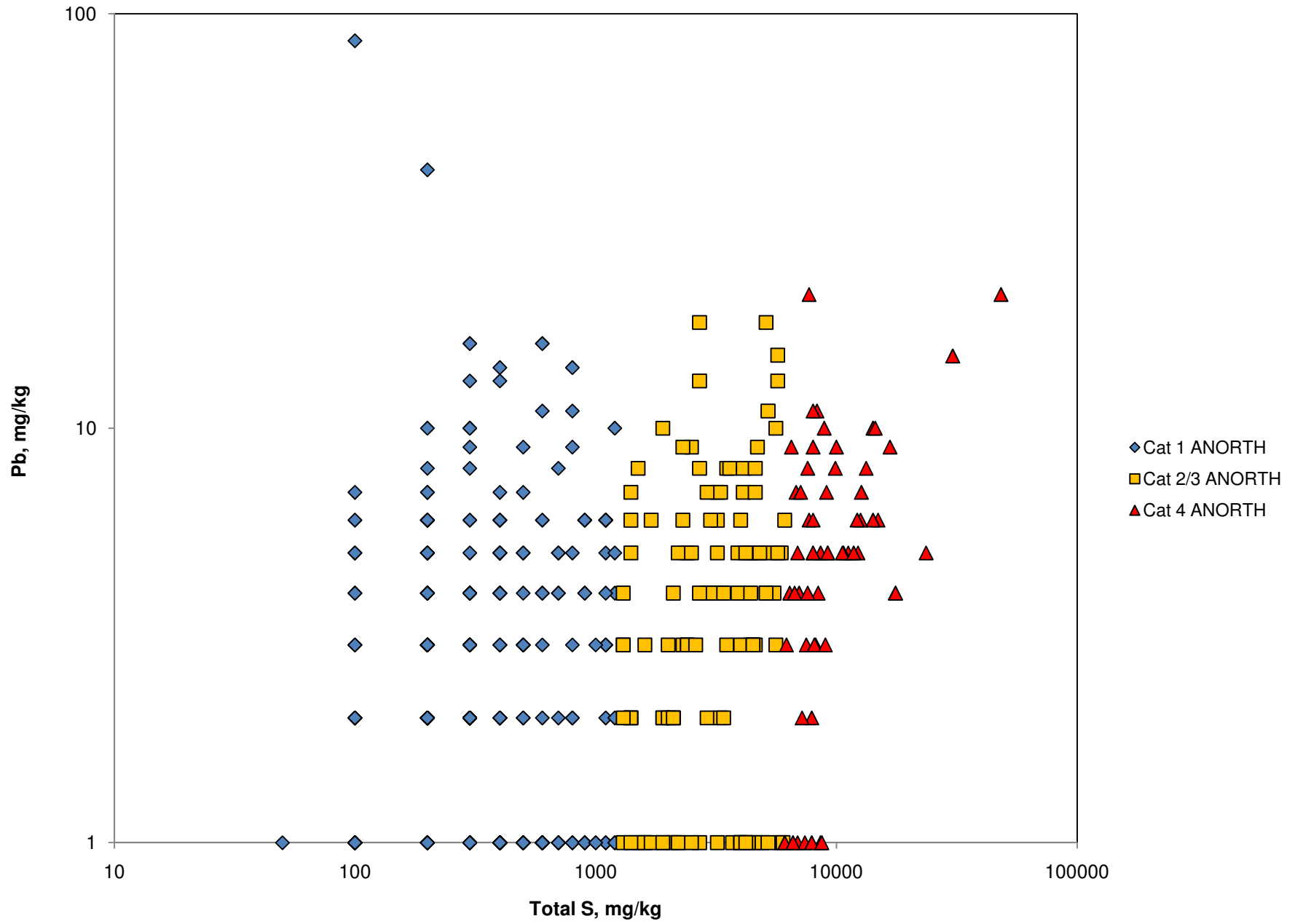

\\Wan-svr0.van.na.srk.ad\ge\_projects\PolyMet Mining\1UP005.01\_Northmet\_project\_2004\Water\_Quality\_Predictions\Waste\_Rock\2011-02\_Collected\_Inputs\_for\_Modeling\Ratios\_In\_Solids\ARMetalRatios\_1UP005001\_SJD\_VER00.xls

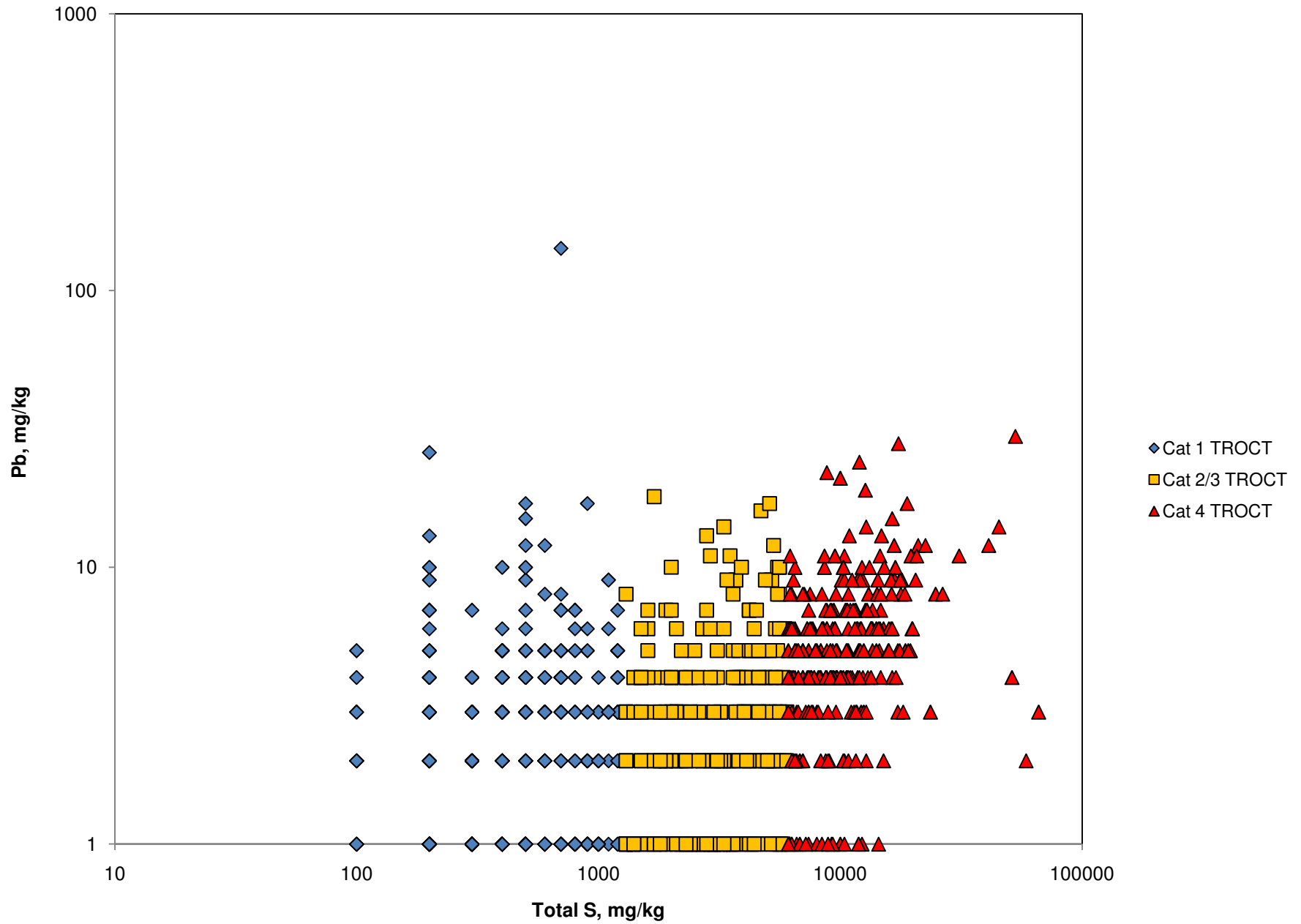

\\Wan-svr0.van.na.srk.ad\ge\_projects\PolyMet Mining\1UP005.01\_Northmet\_project\_2004\Water\_Quality\_Predictions\Waste\_Rock\2011-02\_Collected\_Inputs\_for\_Modeling\Ratios\_In\_Solids\ARMetalRatios\_1UP005001\_SJD\_VER00.xls

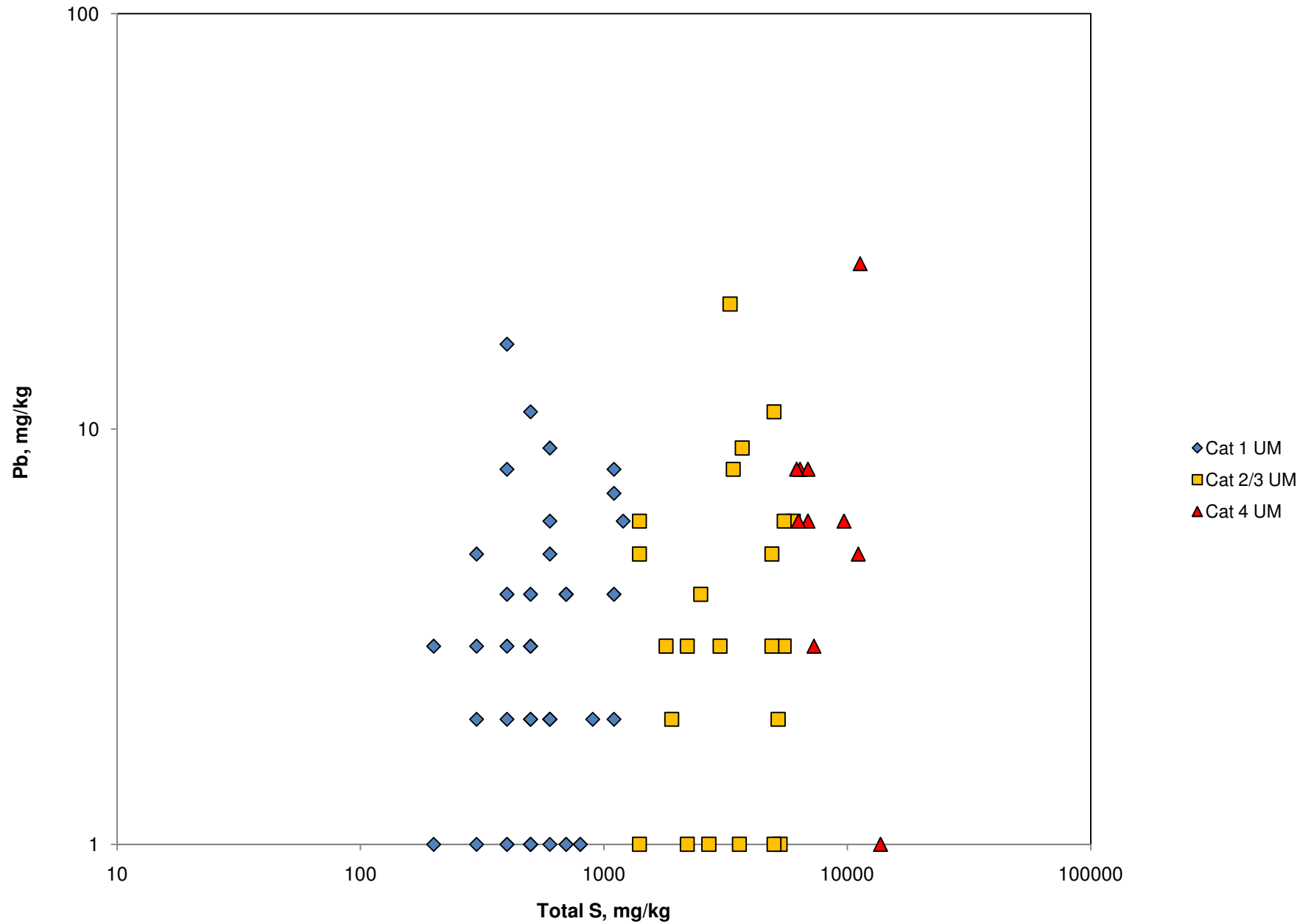

\\Van-svr0.van.na.srk.ad\ge\_projects\PolyMet Mining\1UP005.01\_Northmet\_project\_2004\Water\_Quality\_Predictions\Waste\_Rock\2011-02\_Collected\_Inputs\_for\_Modeling\Ratios\_In\_Solids[ARMetalRatios\_1UP005001\_SJD\_VER00.xls]

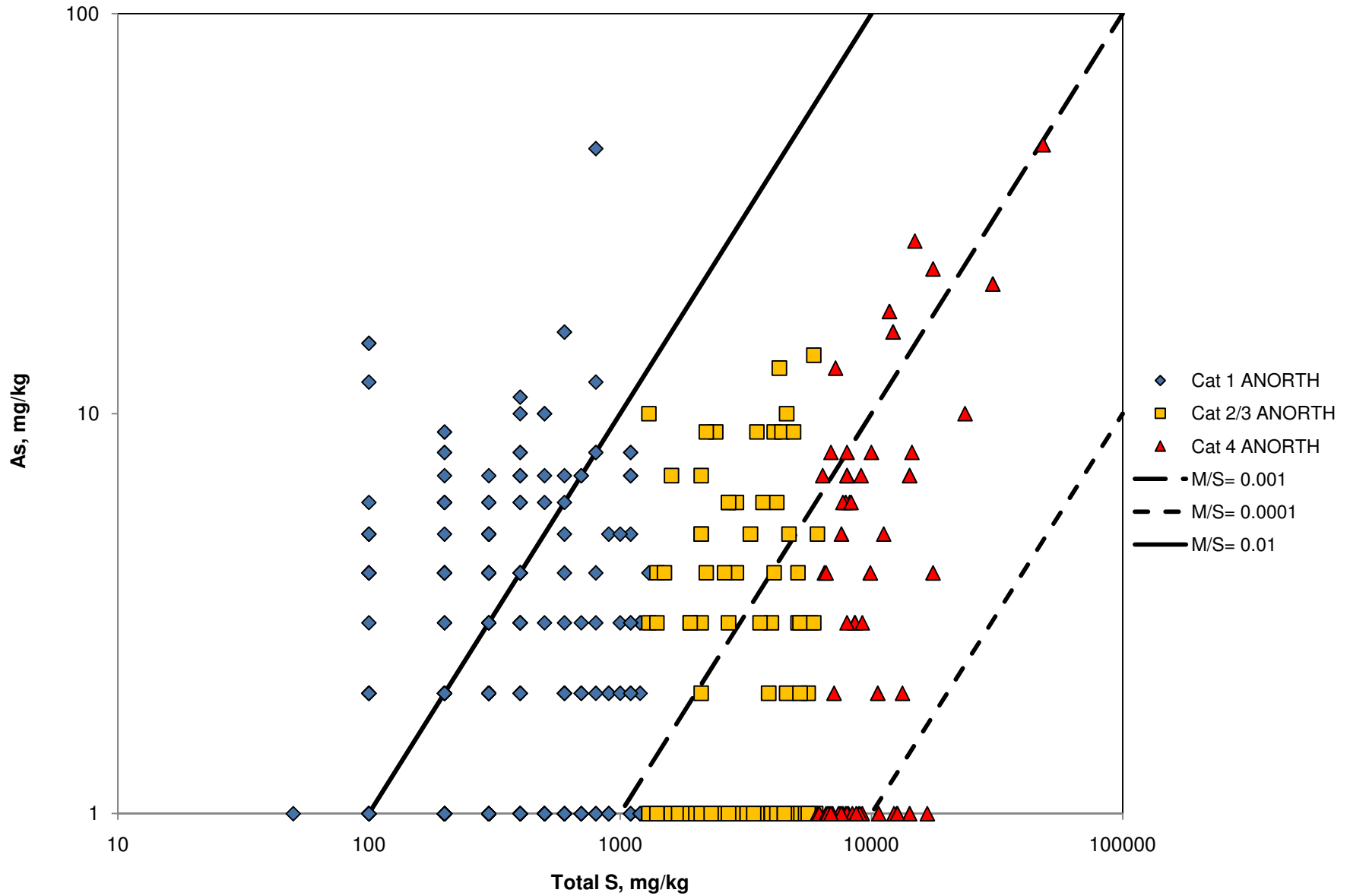

\\Wan-svr0.van.na.srk.ad\ge\_projects\PolyMet Mining\1UP005.01\_Northmet\_project\_2004\Water\_Quality\_Predictions\Waste\_Rock\2011-02\_Collected\_Inputs\_for\_Modeling\Ratios\_In\_Solids[ARMetalRatios\_1UP005001\_SJD\_VER00.xls]

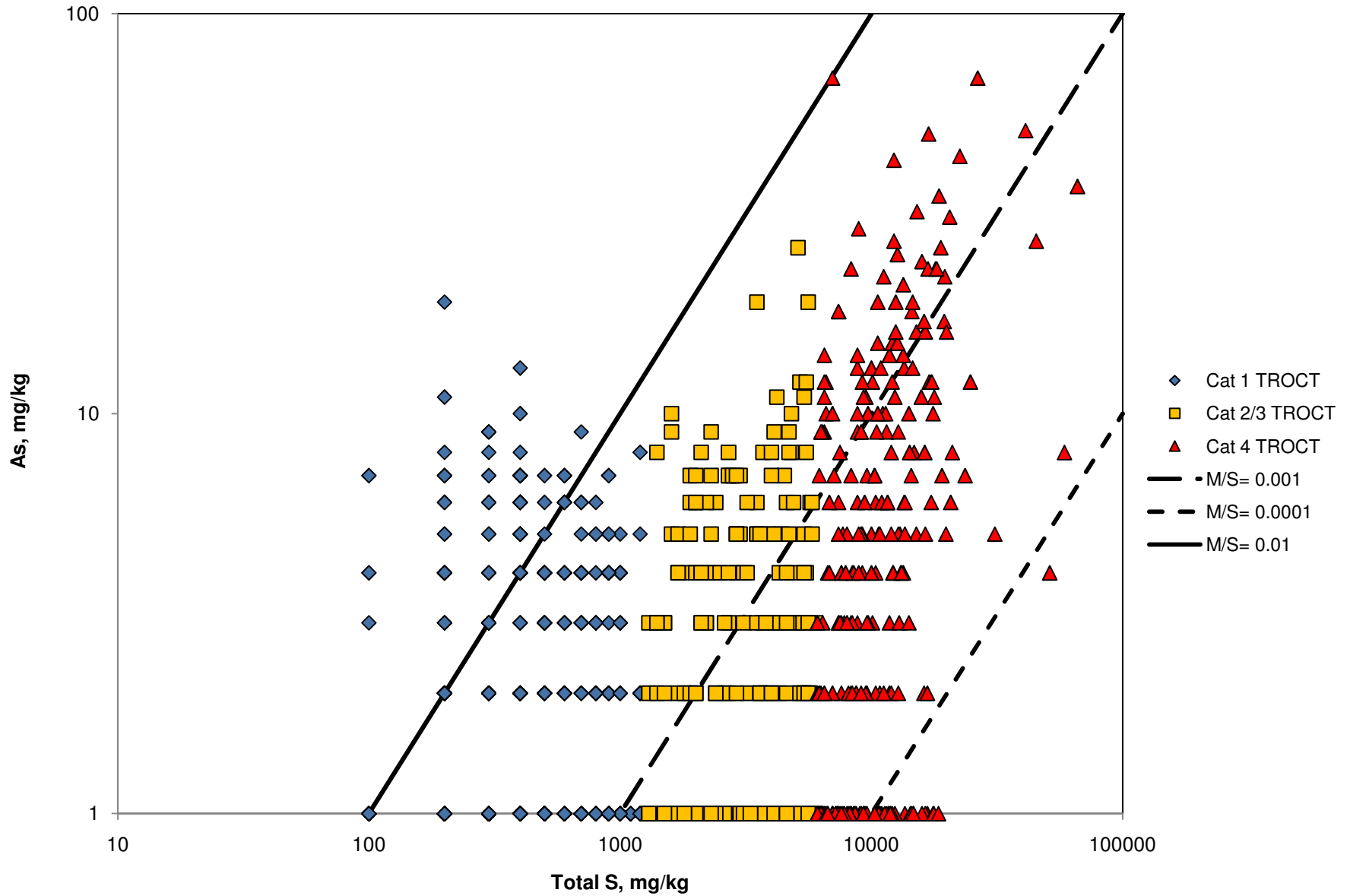

\\Wan-svr0.van.na.srk.ad\ge\_projects\PolyMet Mining\1UP005.01\_Northmet\_project\_2004\Water\_Quality\_Predictions\Waste\_Rock\2011-02\_Collected\_Inputs\_for\_Modeling\Ratios\_In\_Solids[ARMetalRatios\_1UP005001\_SJD\_VER00.xls]

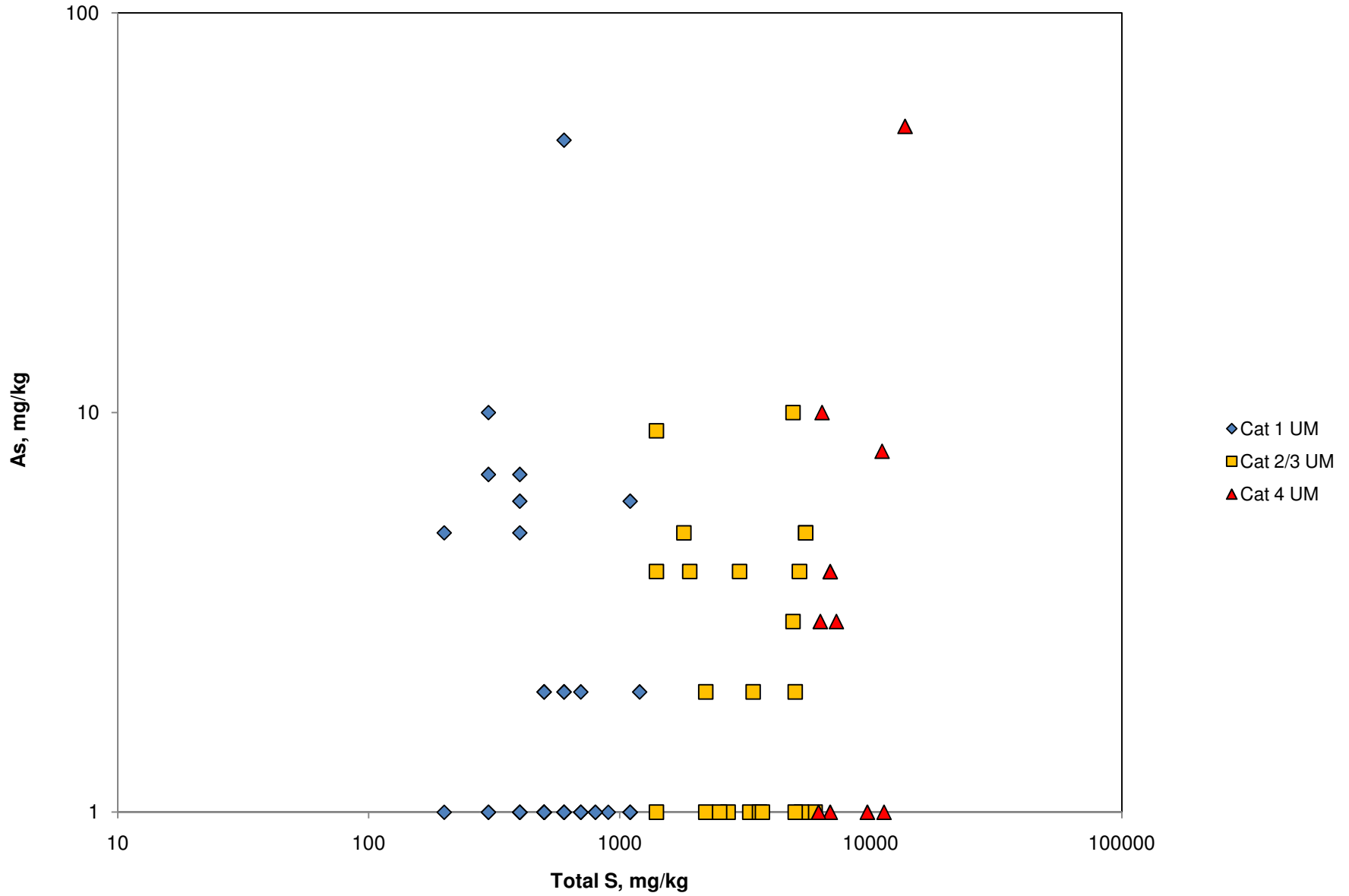

\\Van-svr0.van.na.srk.ad\ge\_projects\PolyMet Mining\1UP005.01\_Northmet\_project\_2004\Water\_Quality\_Predictions\Waste\_Rock\2011-02\_Collected\_Inputs\_for\_Modeling\Ratios\_In\_Solids[ARMetalRatios\_1UP005001\_SJD\_VER00.xls]



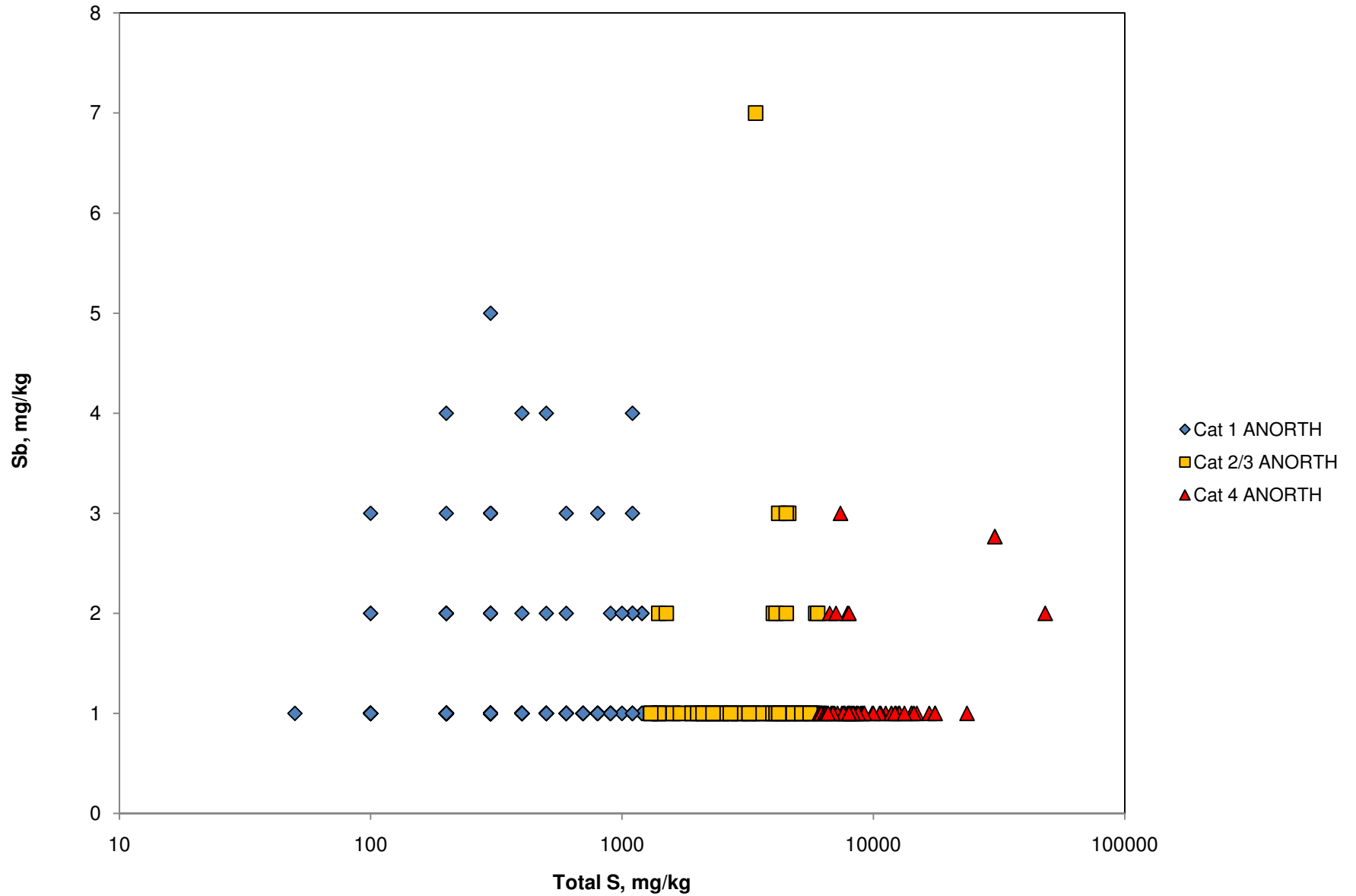

\\Wan-svr0.van.na.srk.ad\ge\_projects\PolyMet Mining\1UP005.01\_Northmet\_project\_2004\Water\_Quality\_Predictions\Waste\_Rock\2011-02\_Collected\_Inputs\_for\_Modeling\Ratios\_In\_Solids[ARMetalRatios\_1UP005001\_SJD\_VER00.xls]

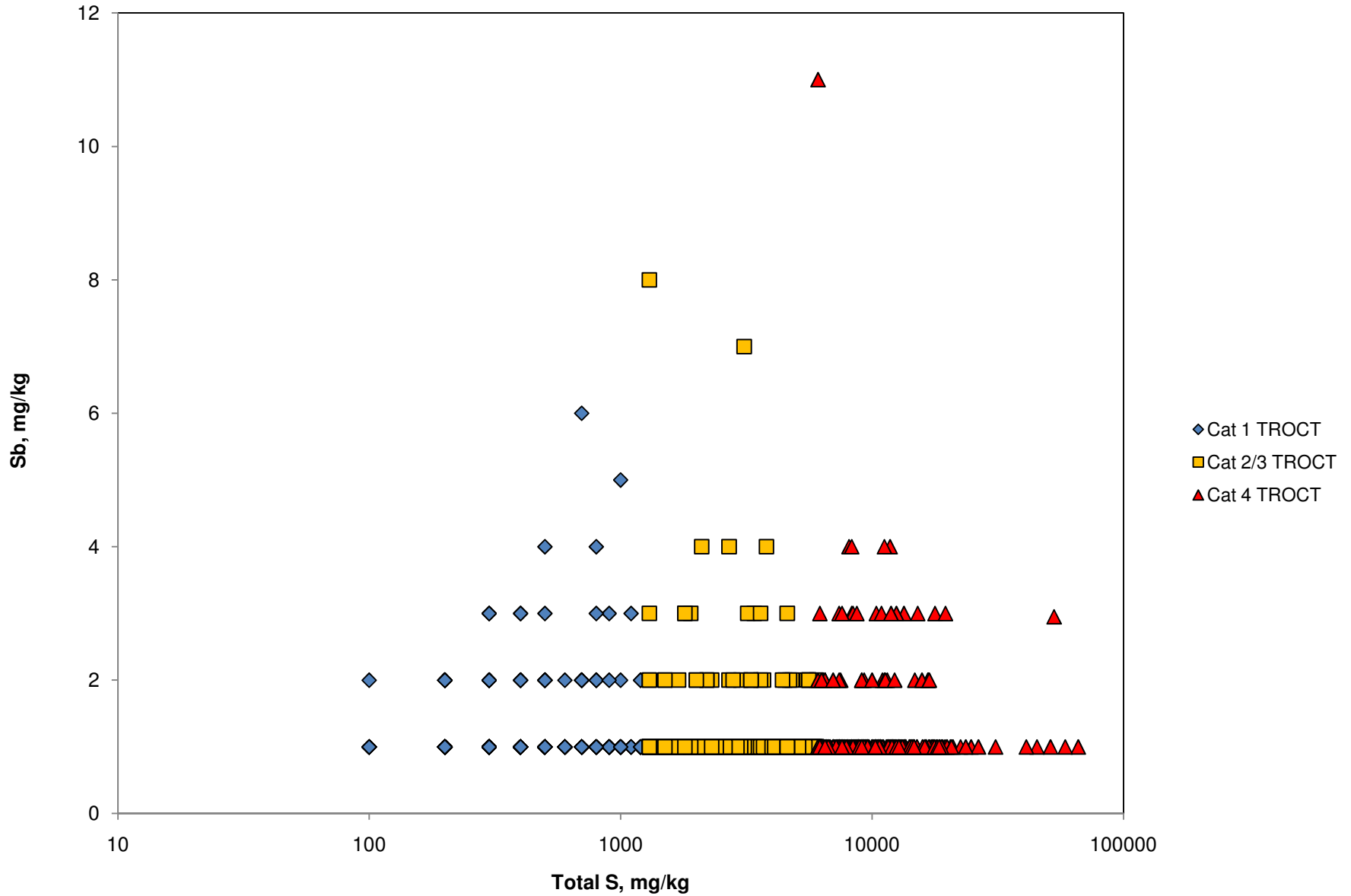

\\Van-svr0.van.na.srk.ad\ge\_projects\PolyMet Mining\1UP005.01\_Northmet\_project\_2004\Water\_Quality\_Predictions\Waste\_Rock\2011-02\_Collected\_Inputs\_for\_Modeling\Ratios\_In\_Solids[ARMetalRatios\_1UP005001\_SJD\_VER00.xls]

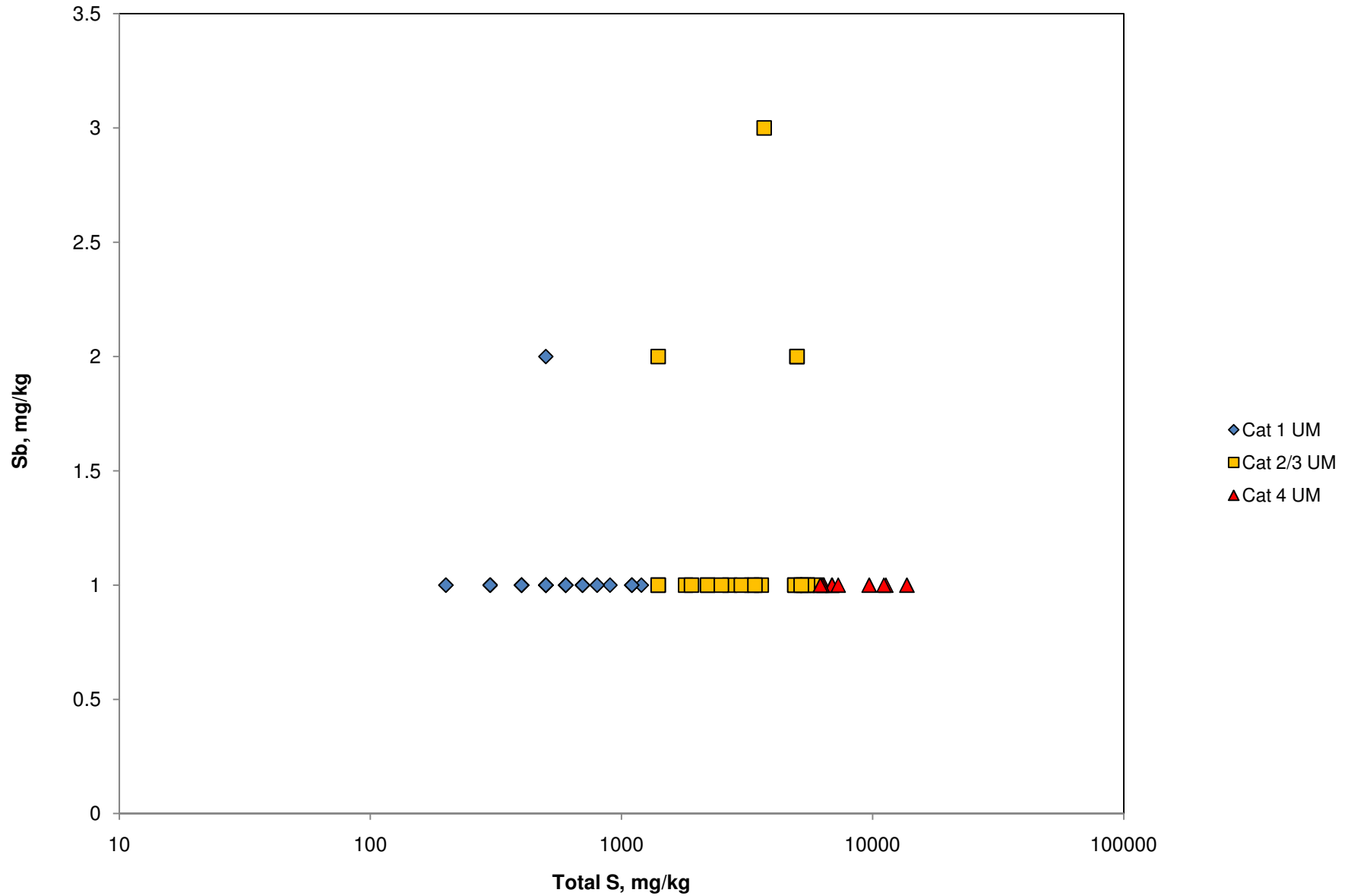

\\Van-svr0.van.na.srk.ad\ge\_projects\PolyMet Mining\1UP005.01\_Northmet\_project\_2004\Water\_Quality\_Predictions\Waste\_Rock\2011-02\_Collected\_Inputs\_for\_Modeling\Ratios\_In\_Solids[ARMetalRatios\_1UP005001\_SJD\_VER00.xls]

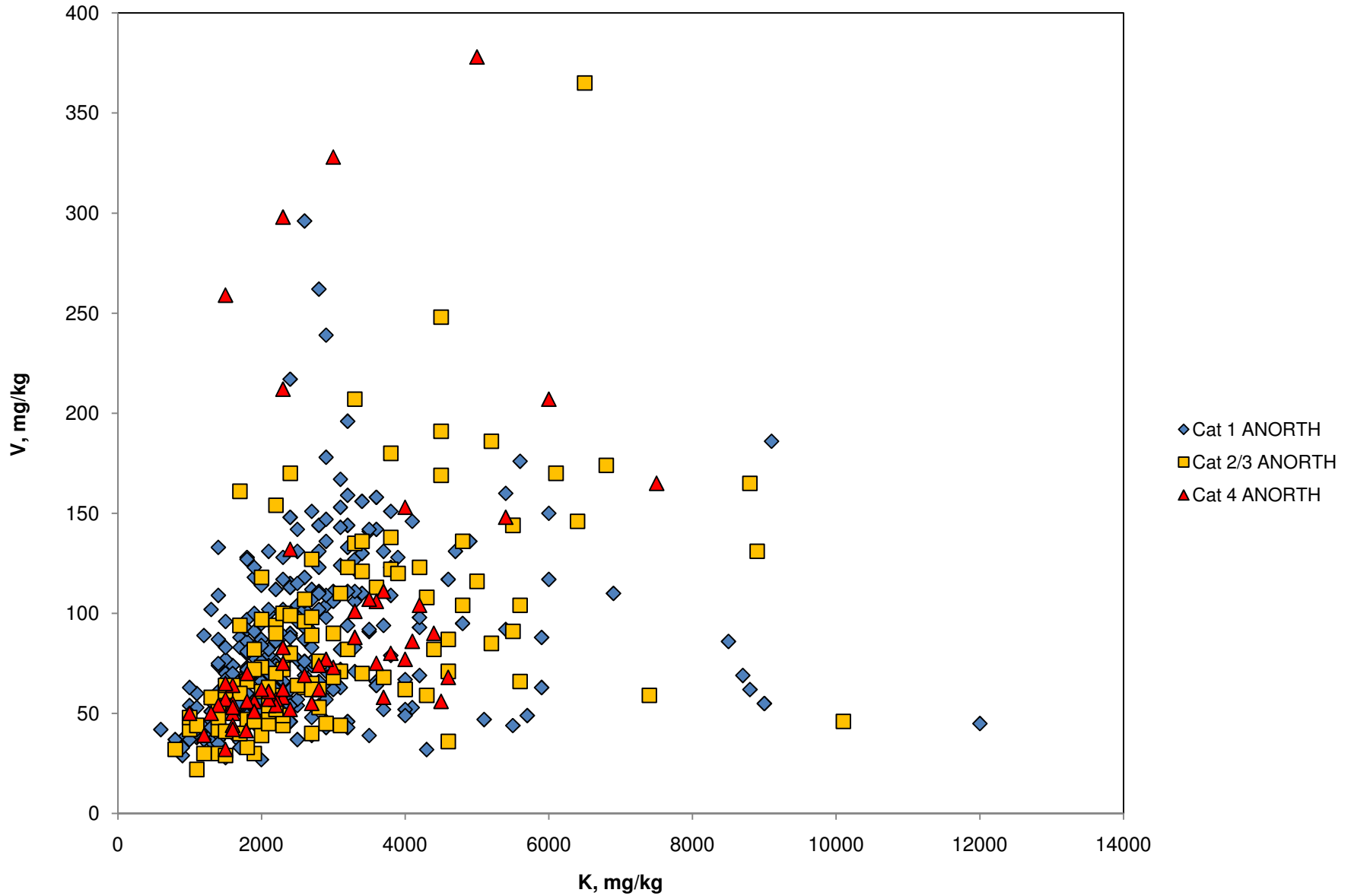

\\Wan-svr0.van.na.srk.ad\ge\_projects\PolyMet Mining\1UP005.01\_Northmet\_project\_2004\Water\_Quality\_Predictions\Waste\_Rock\2011-02\_Collected\_Inputs\_for\_Modeling\Ratios\_In\_Solids\ARMetalRatios\_1UP005001\_SJD\_VER00.xls

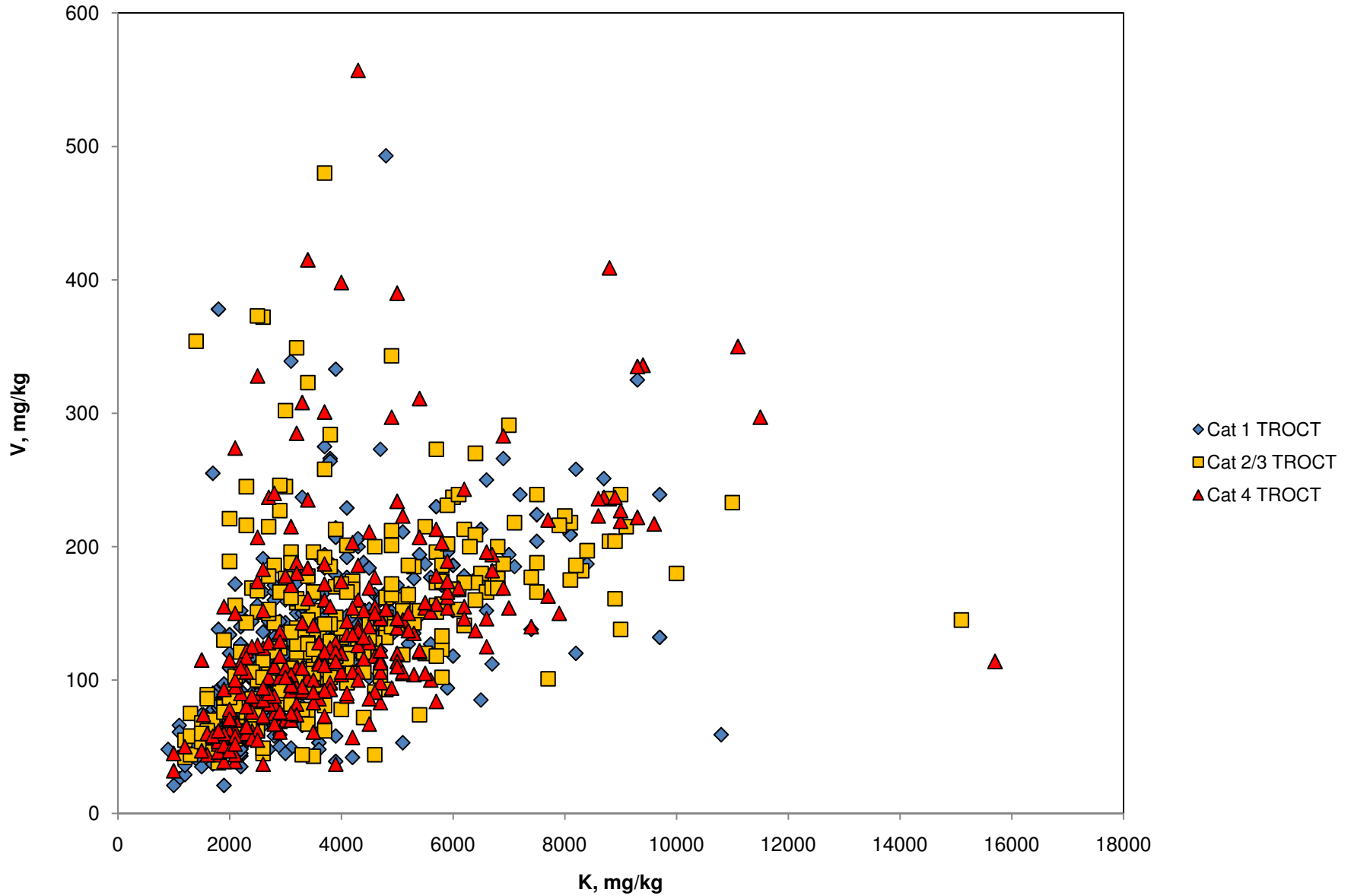

\\van-svr0.van.na.srk.ad\ge\_projects\PolyMet Mining\1UP005.01\_Northmet\_project\_2004\Water\_Quality\_Predictions\Waste\_Rock\2011-02\_Collected\_Inputs\_for\_Modeling\Ratios\_In\_Solids\ARMetalRatios\_1UP005001\_SJD\_VER00.xls

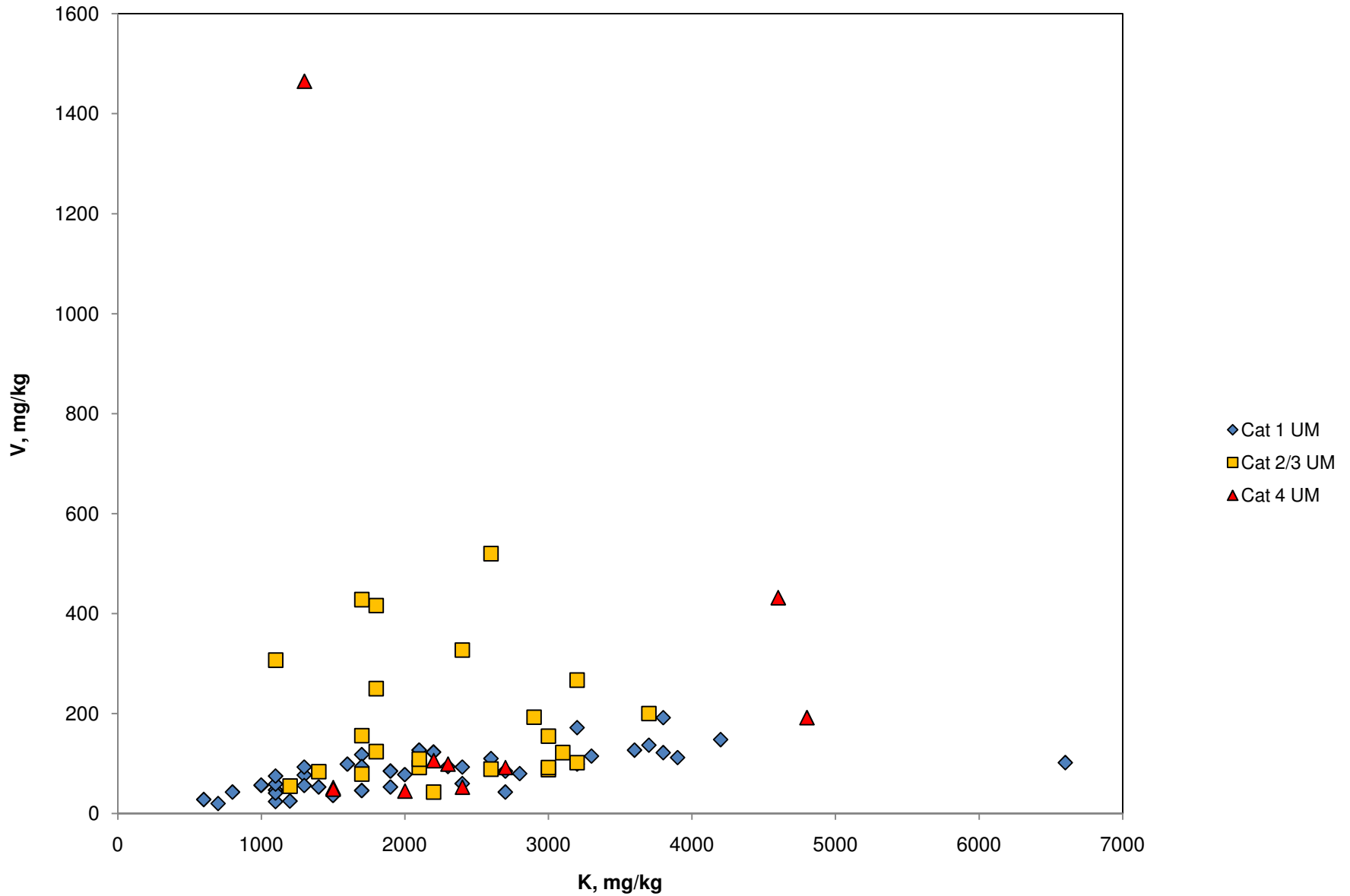

\\Wan-svr0.van.na.srk.ad\ge\_projects\PolyMet Mining\1UP005.01\_Northmet\_project\_2004\Water\_Quality\_Predictions\Waste\_Rock\2011-02\_Collected\_Inputs\_for\_Modeling\Ratios\_In\_Solids\{ARMetalRatios\_1UP005001\_SJD\_VER00.xls}

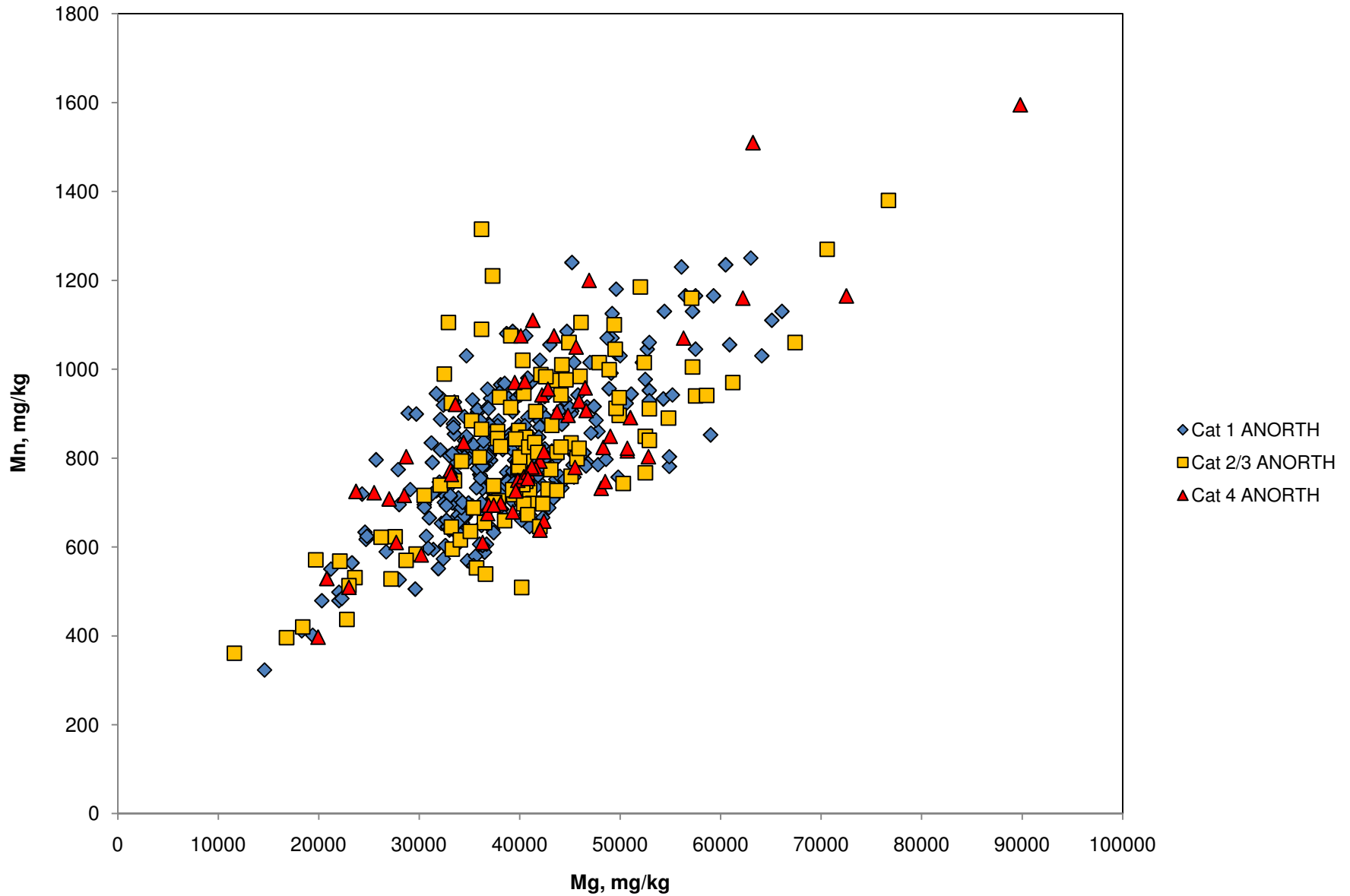

\\Wan-svr0.van.na.srk.ad\ge\_projects\PolyMet Mining\1UP005.01\_Northmet\_project\_2004\Water\_Quality\_Predictions\Waste\_Rock\2011-02\_Collected\_Inputs\_for\_Modeling\Ratios\_In\_Solids\{ARMetalRatios\_1UP005001\_SJD\_VER00.xls}

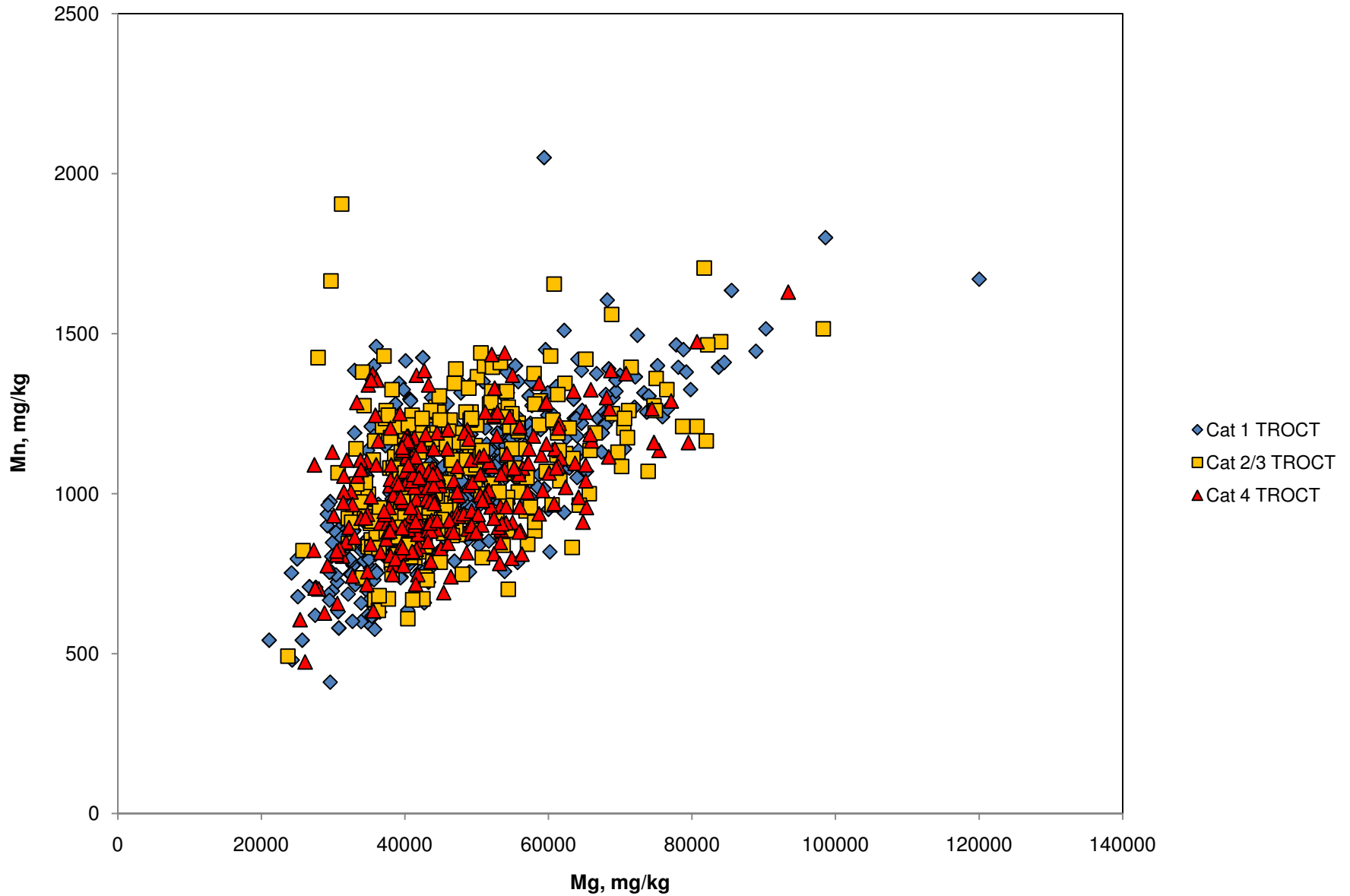

\\Van-svr0.van.na.srk.ad\ge\_projects\PolyMet Mining\1UP005.01\_Northmet\_project\_2004\Water\_Quality\_Predictions\Waste\_Rock\2011-02\_Collected\_Inputs\_for\_Modeling\Ratios\_In\_Solids\{ARMetalRatios\_1UP005001\_SJD\_VER00.xls}



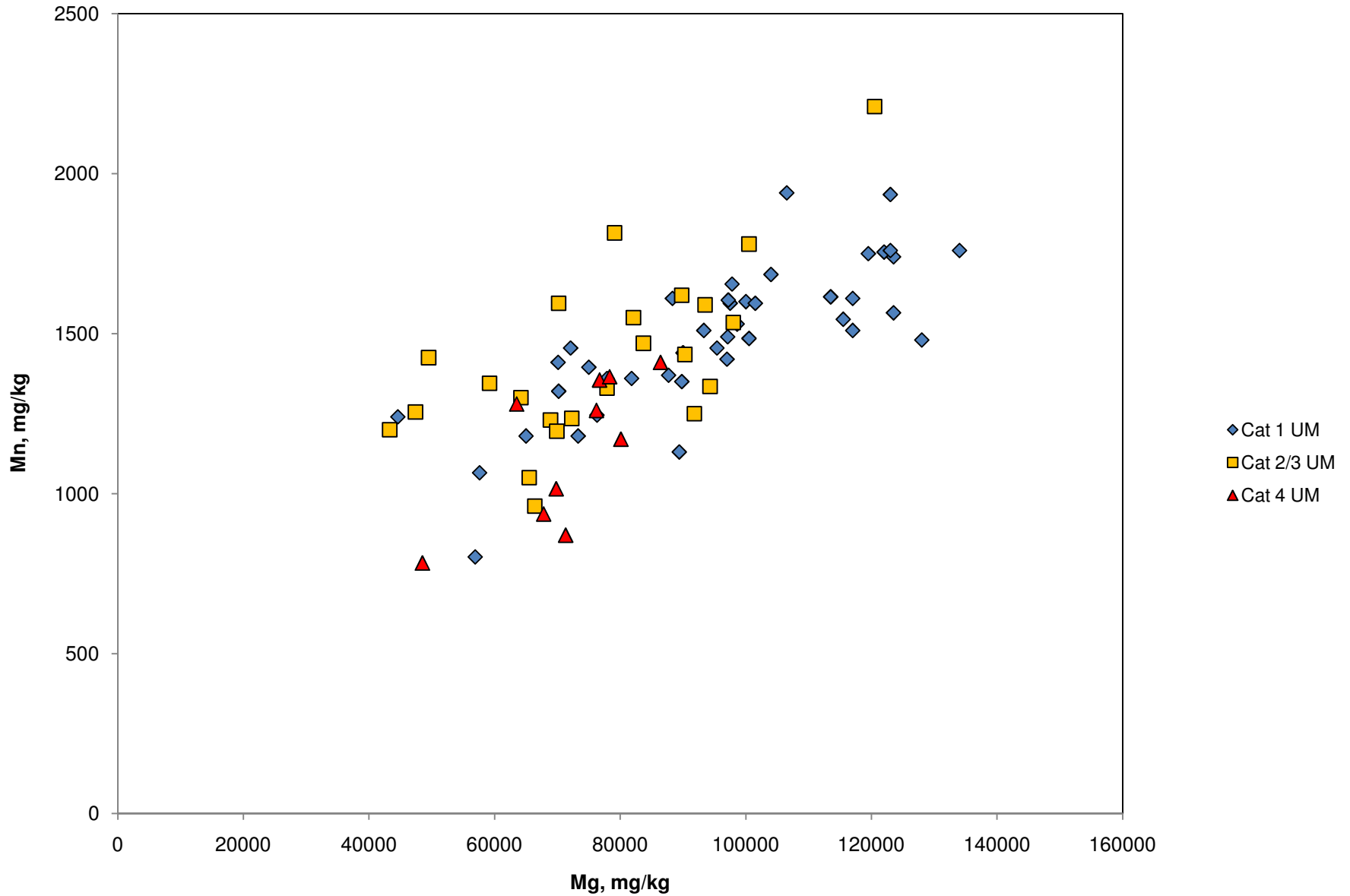

\\Van-svr0.van.na.srk.ad\ge\_projects\PolyMet Mining\1UP005.01\_Northmet\_project\_2004\Water\_Quality\_Predictions\Waste\_Rock\2011-02\_Collected\_Inputs\_for\_Modeling\Ratios\_In\_Solids[ARMetalRatios\_1UP005001\_SJD\_VER00.xls]

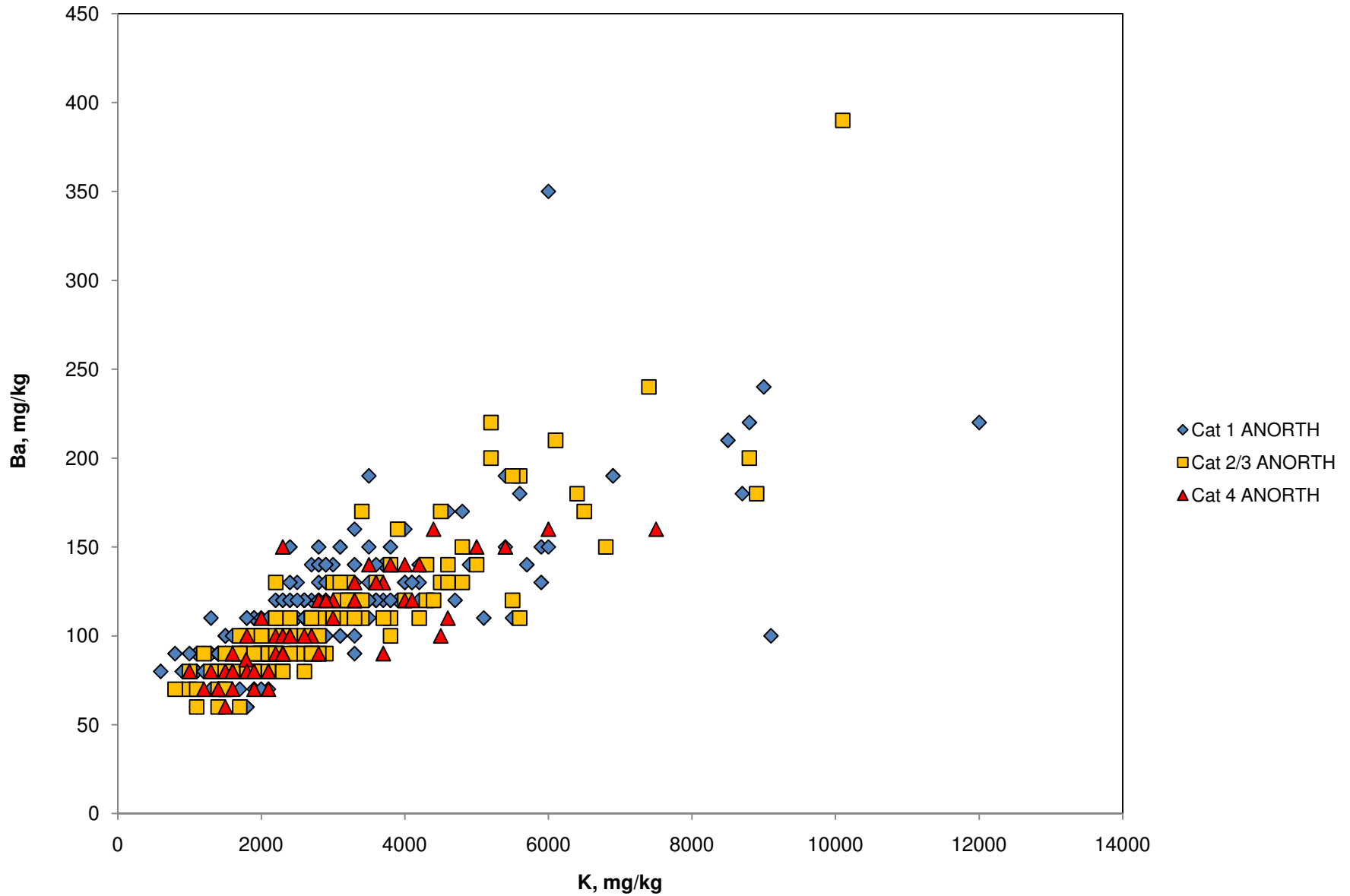

\\Wan-svr0.van.na.srk.ad\ge\_projects\PolyMet Mining\1UP005.01\_Northmet\_project\_2004\Water\_Quality\_Predictions\Waste\_Rock\2011-02\_Collected\_Inputs\_for\_Modeling\Ratios\_In\_Solids\{ARMetalRatios\_1UP005001\_SJD\_VER00.xls}

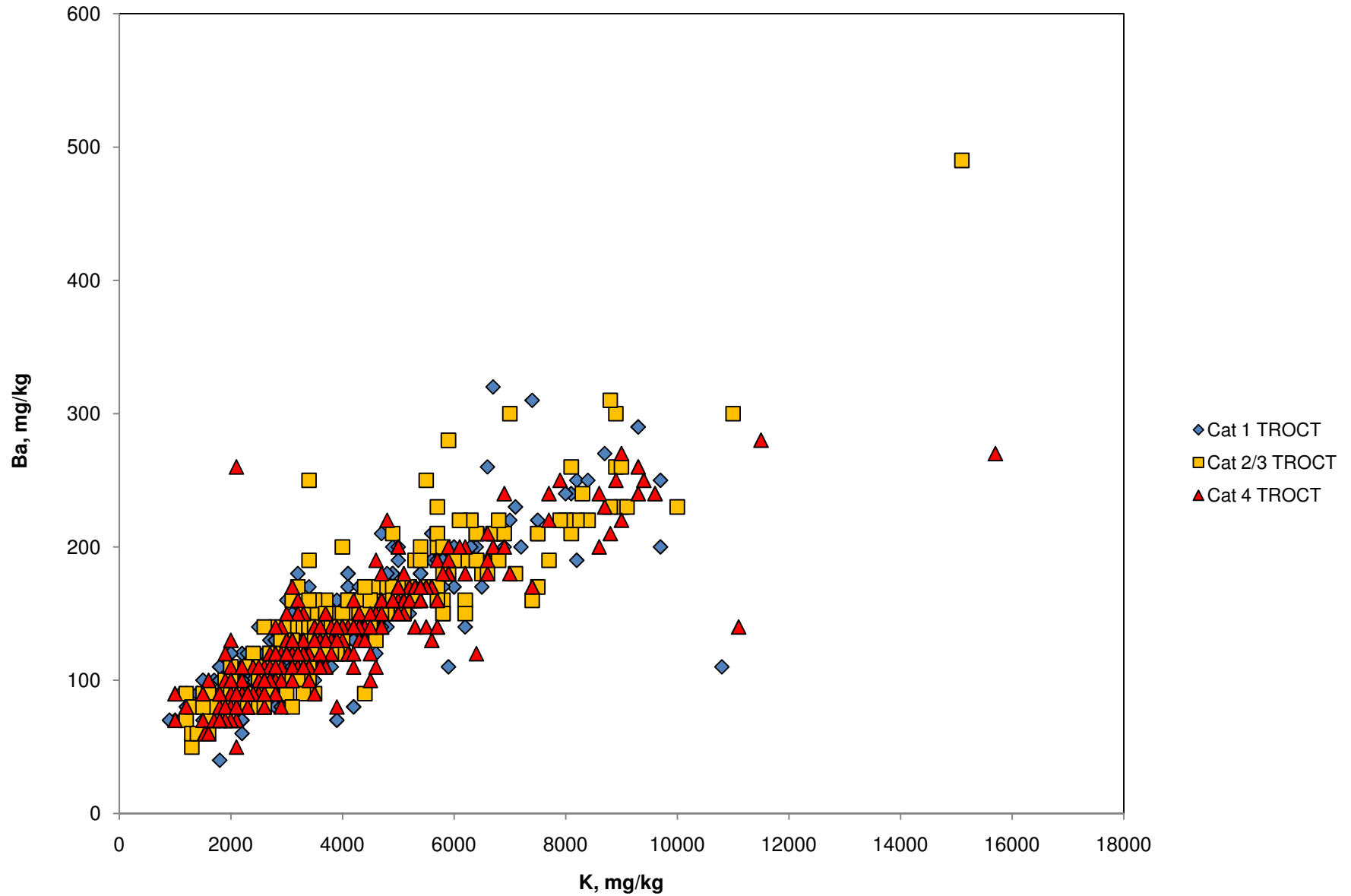

\\Wan-svr0.van.na.srk.ad\ge\_projects\PolyMet Mining\1UP005.01\_Northmet\_project\_2004\Water\_Quality\_Predictions\Waste\_Rock\2011-02\_Collected\_Inputs\_for\_Modeling\Ratios\_In\_Solids\ARMetalRatios\_1UP005001\_SJD\_VER00.xls

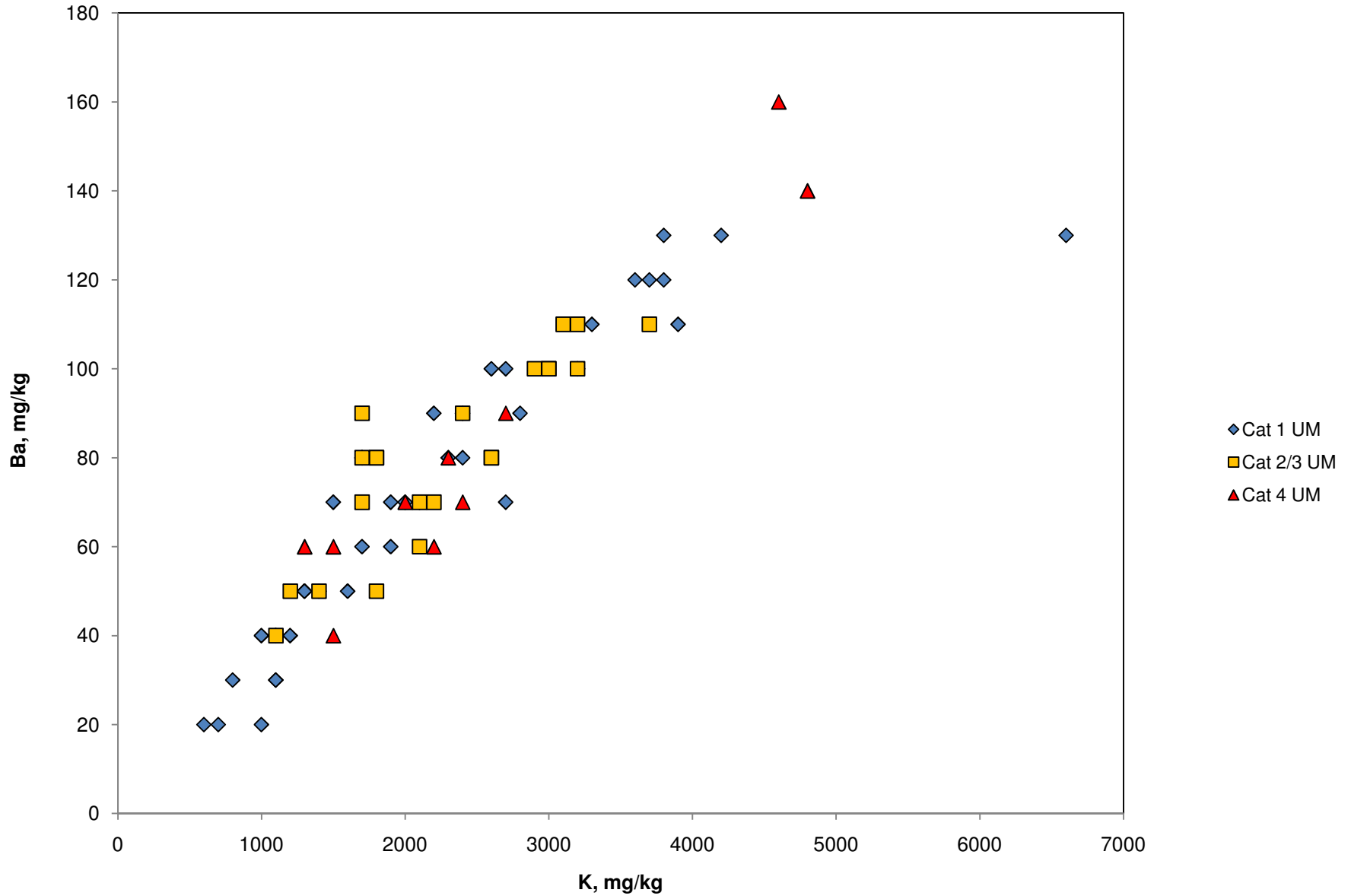

\\Wan-svr0.van.na.srk.ad\ge\_projects\PolyMet Mining\1UP005.01\_Northmet\_project\_2004\Water\_Quality\_Predictions\Waste\_Rock\2011-02\_Collected\_Inputs\_for\_Modeling\Ratios\_In\_Solids[ARMetalRatios\_1UP005001\_SJD\_VER00.xls]

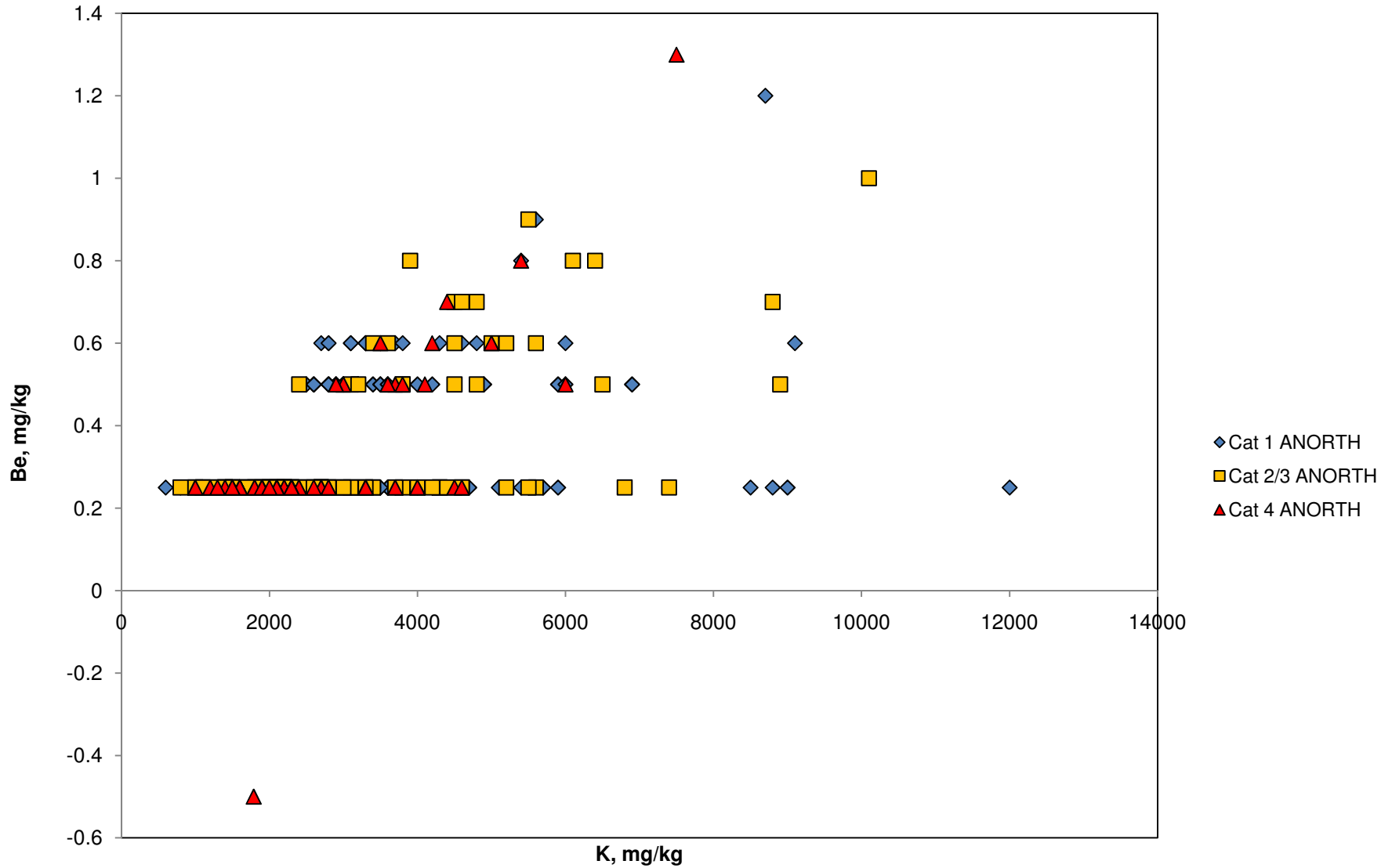

\\Van-svr0.van.na.srk.ad\ge\_projects\PolyMet Mining\1UP005.01\_Northmet\_project\_2004\Water\_Quality\_Predictions\Waste\_Rock\2011-02\_Collected\_Inputs\_for\_Modeling\Ratios\_In\_Solids\ARMetalRatios\_1UP005001\_SJD\_VER00.xls]

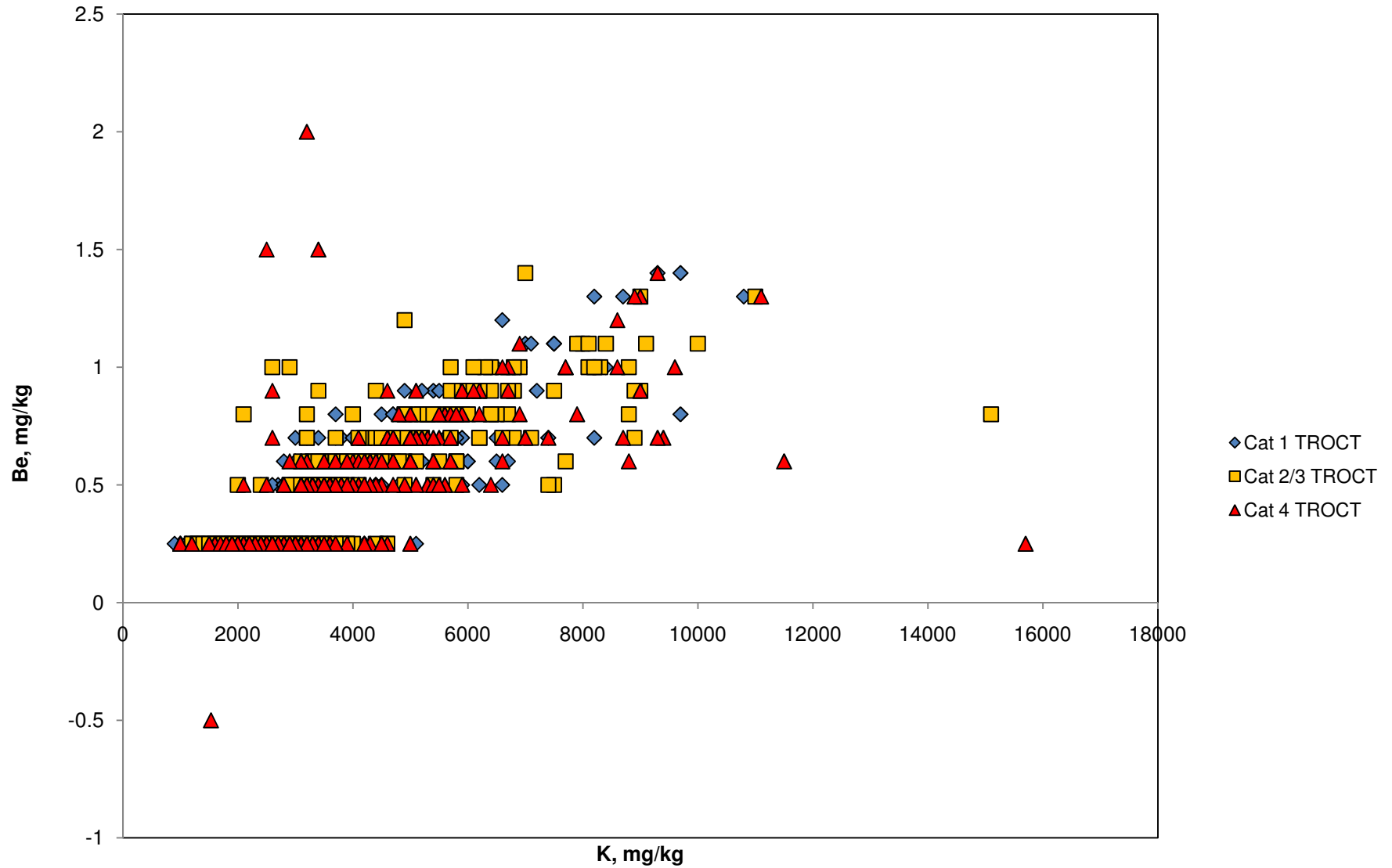

\\Van-svr0.van.na.srk.ad\ge\_projects\PolyMet Mining\1UP005.01\_Northmet\_project\_2004\Water\_Quality\_Predictions\Waste\_Rock\2011-02\_Collected\_Inputs\_for\_Modeling\Ratios\_In\_Solids\ARMetalRatios\_1UP005001\_SJD\_VER00.xls

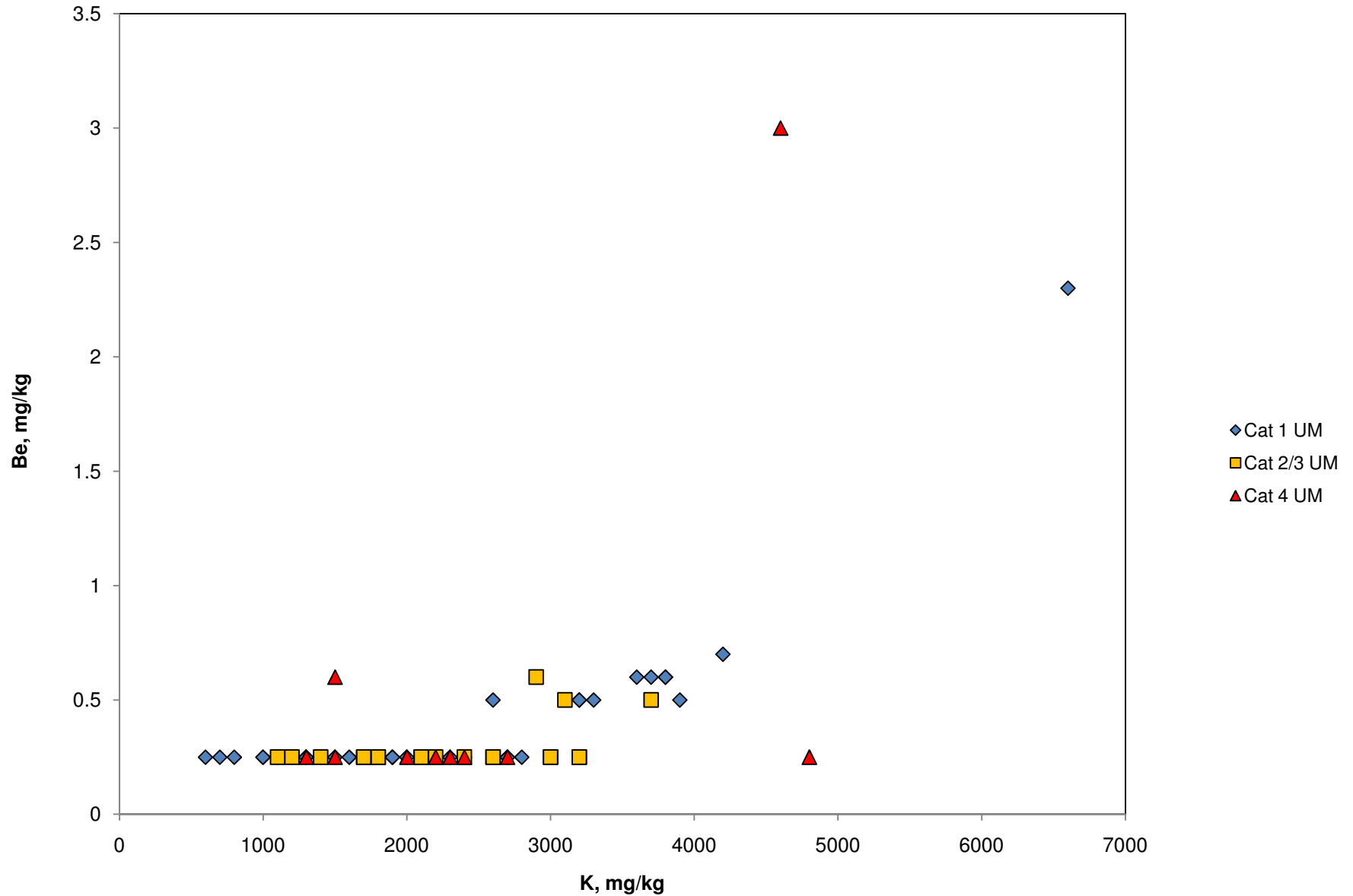

\\Van-svr0.van.na.srk.ad\ge\_projects\PolyMet Mining\1UP005.01\_Northmet\_project\_2004\Water\_Quality\_Predictions\Waste\_Rock\2011-02\_Collected\_Inputs\_for\_Modeling\Ratios\_In\_Solids\ARMetalRatios\_1UP005001\_SJD\_VER00.xls

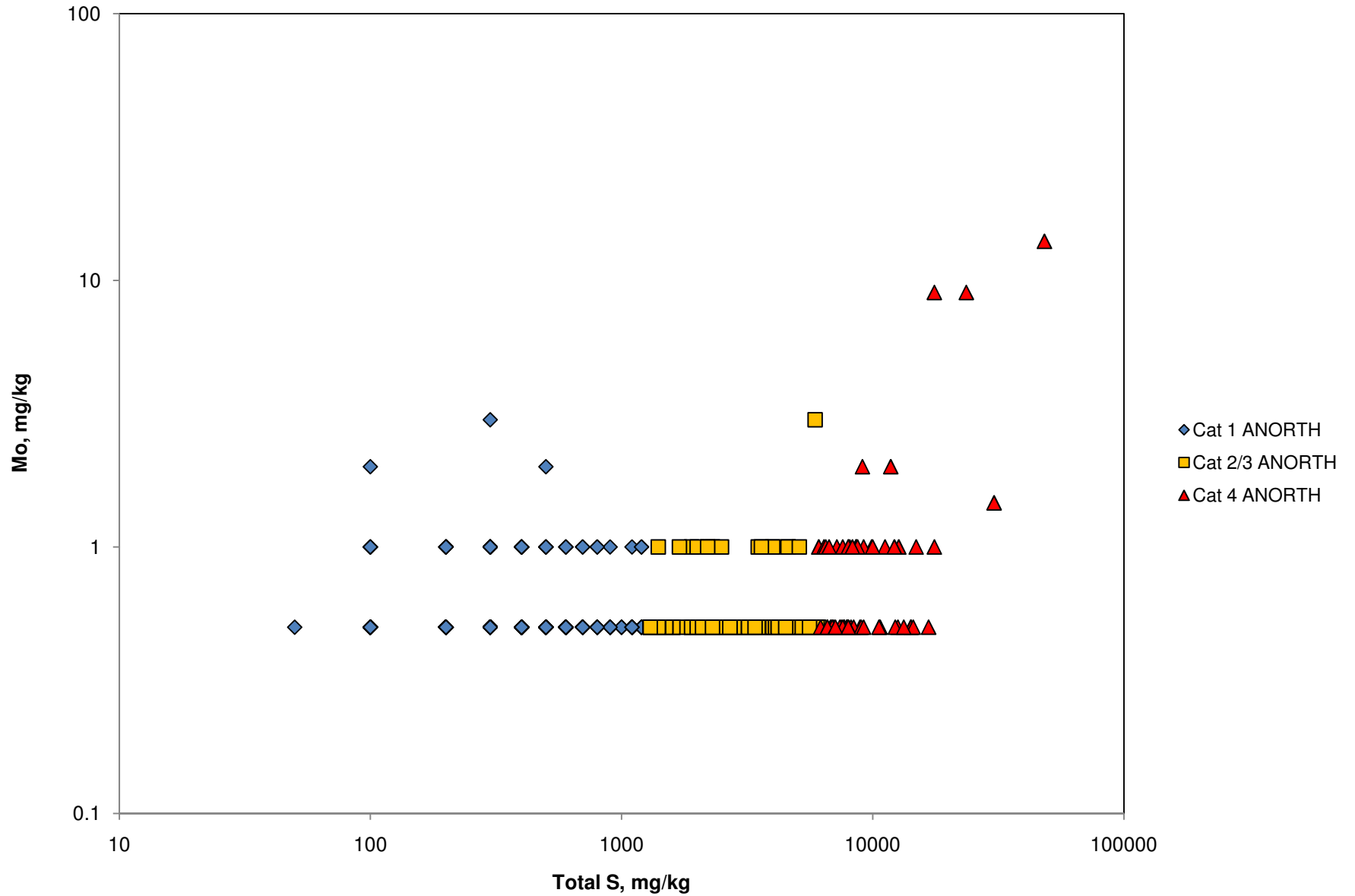

\\Van-svr0.van.na.srk.ad\ge\_projects\PolyMet Mining\1UP005.01\_Northmet\_project\_2004\Water\_Quality\_Predictions\Waste\_Rock\2011-02\_Collected\_Inputs\_for\_Modeling\Ratios\_In\_Solids\ARMetalRatios\_1UP005001\_SJD\_VER00.xls



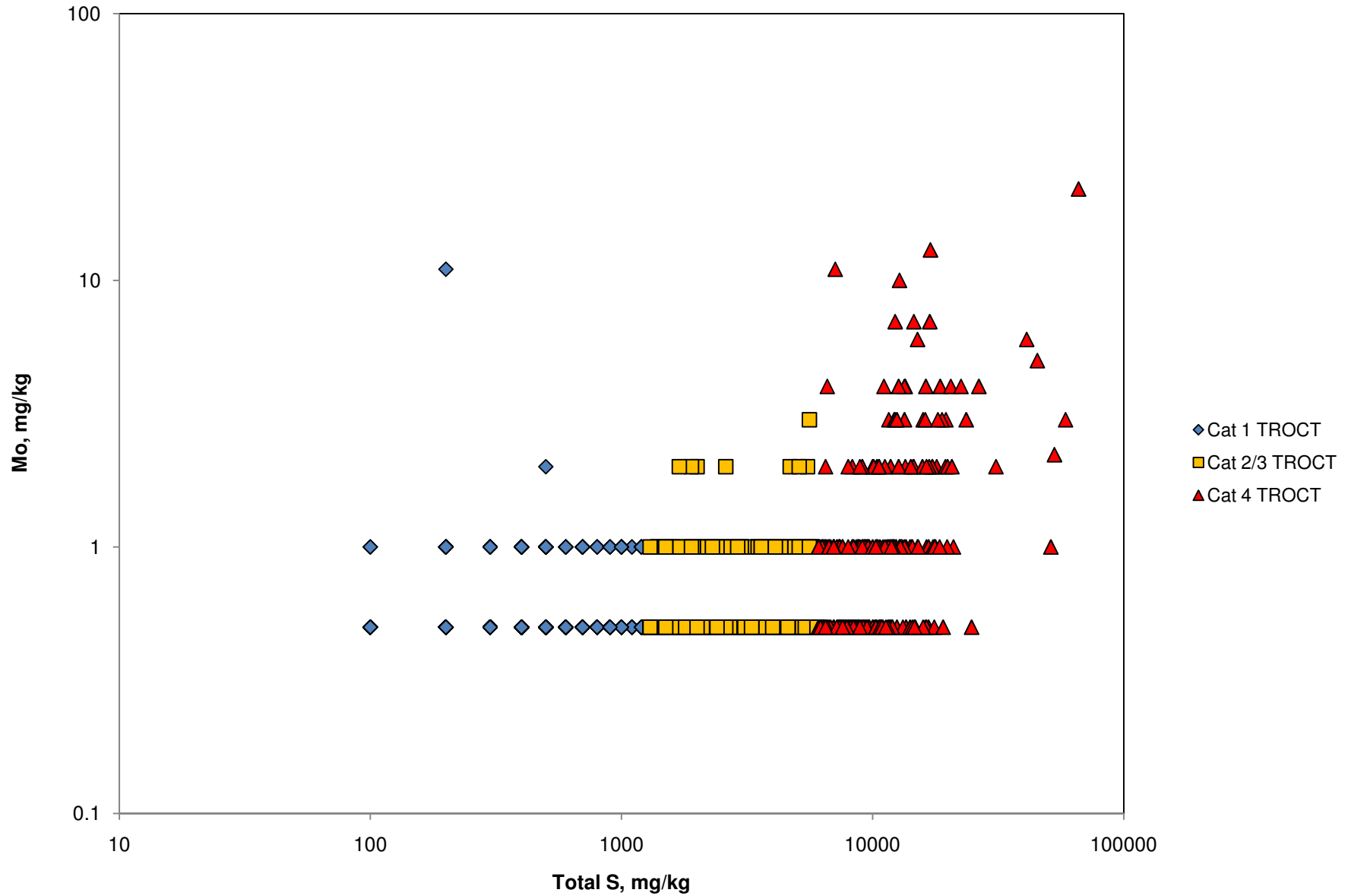

\\Van-svr0.van.na.srk.ad\ge\_projects\PolyMet Mining\1UP005.01\_Northmet\_project\_2004\Water\_Quality\_Predictions\Waste\_Rock\2011-02\_Collected\_Inputs\_for\_Modeling\Ratios\_In\_Solids[ARMetalRatios\_1UP005001\_SJD\_VER00.xls]

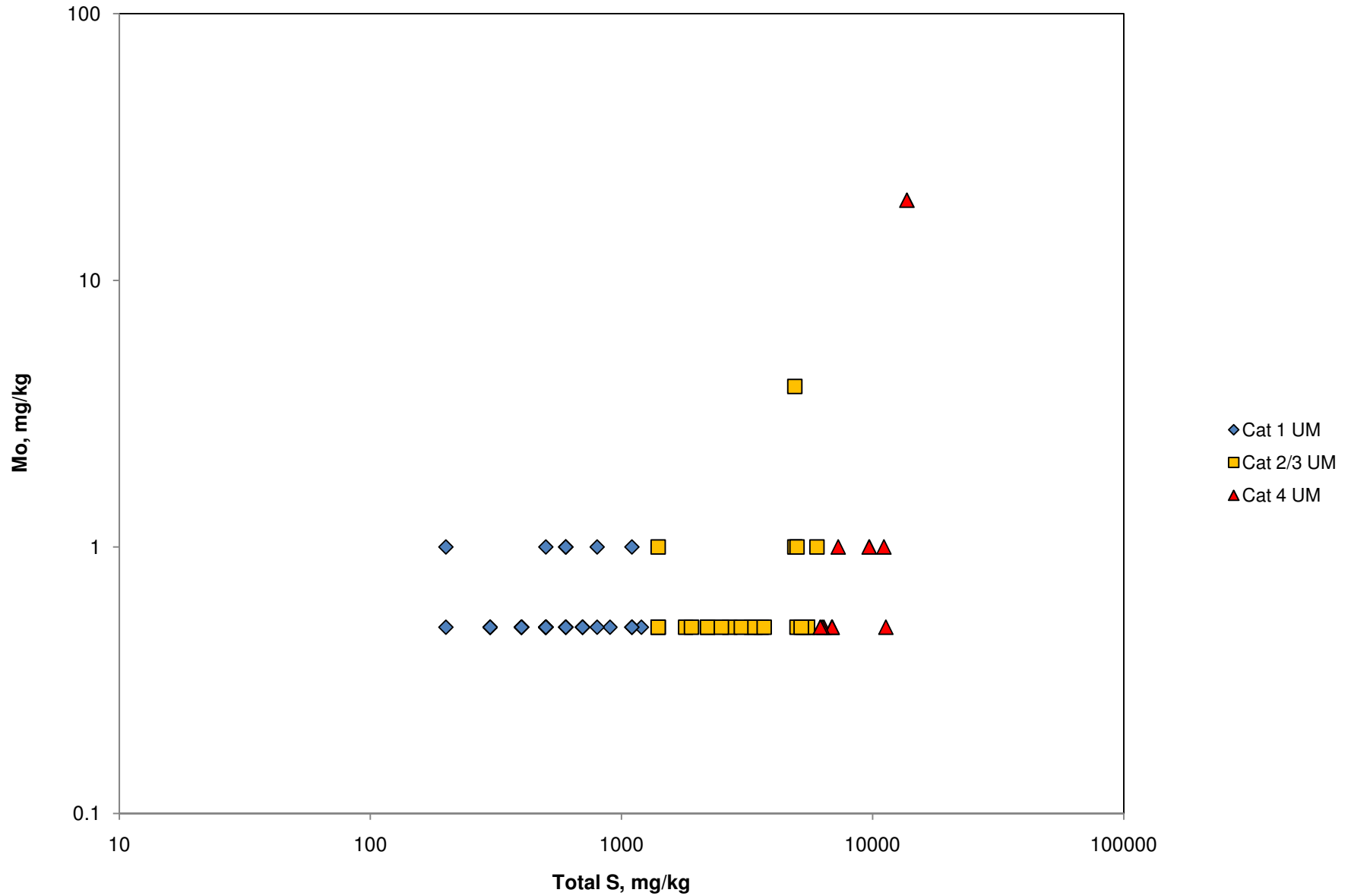

\\Van-svr0.van.na.srk.ad\ge\_projects\PolyMet Mining\1UP005.01\_Northmet\_project\_2004\Water\_Quality\_Predictions\Waste\_Rock\2011-02\_Collected\_Inputs\_for\_Modeling\Ratios\_In\_Solids[ARMetalRatios\_1UP005001\_SJD\_VER00.xls]

## Virginia Formation

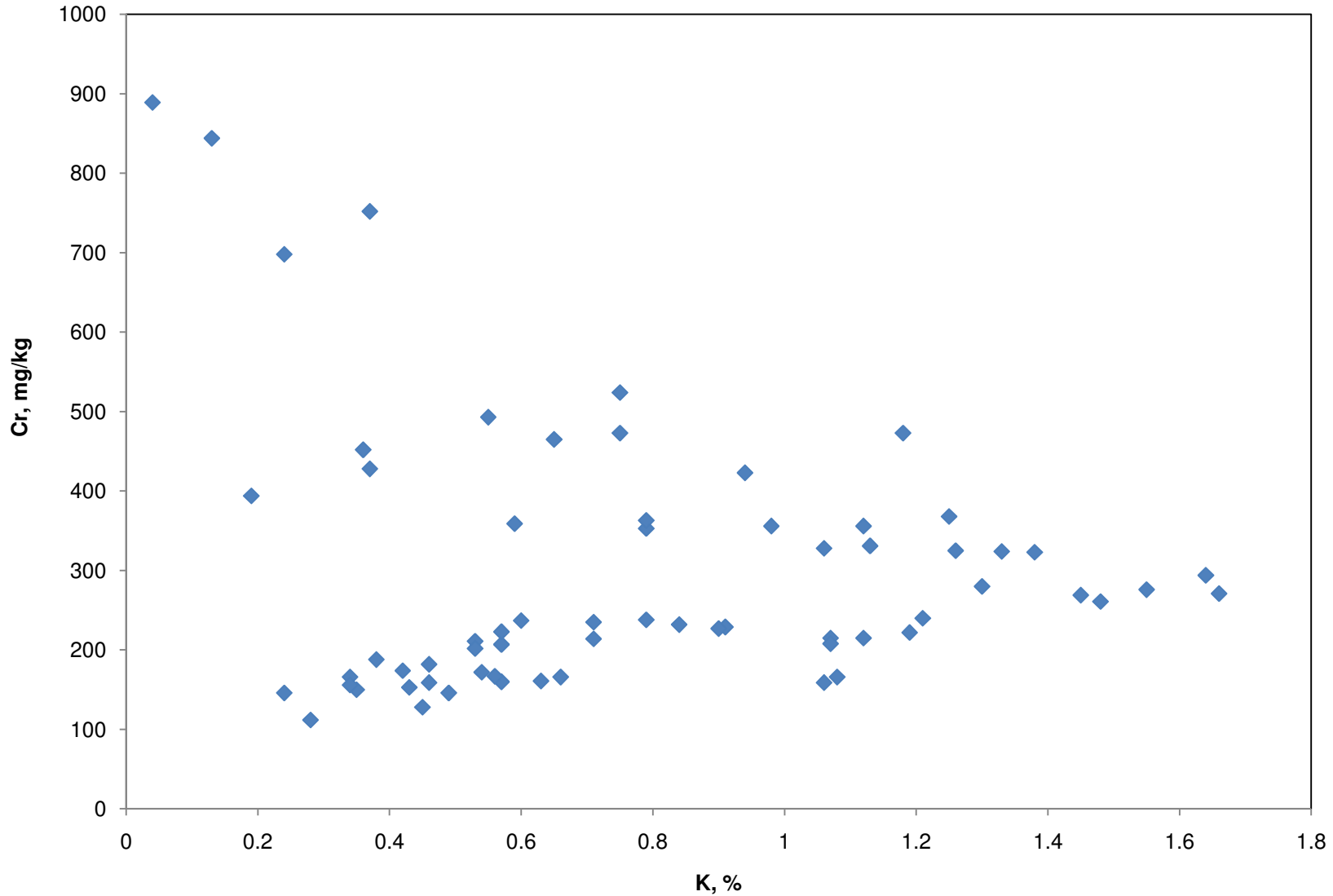

\\Van-svr0.van.na.srk.ad\ge projects\PolyMet Mining\1UP005.01 Northmet project 2004\Water Quality Predictions\Waste Rock\2011-

## Virginia Formation

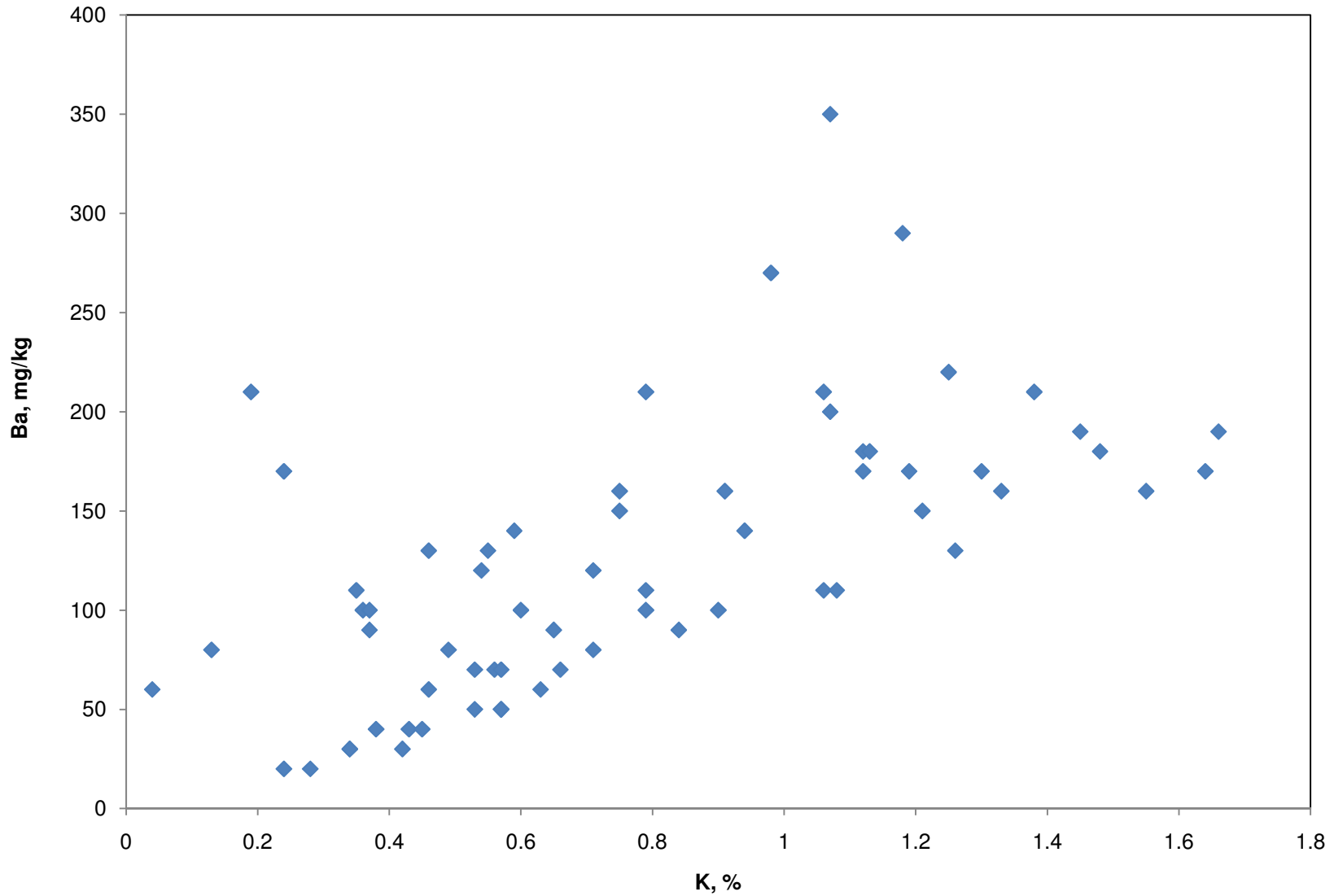

\\Van-svr0.van.na.srk.ad\ge\_projects\PolyMet Mining\1UP005.01\_Northmet\_project\_2004\Water\_Quality\_Predictions\Waste\_Rock\2011-

### Virginia Formation

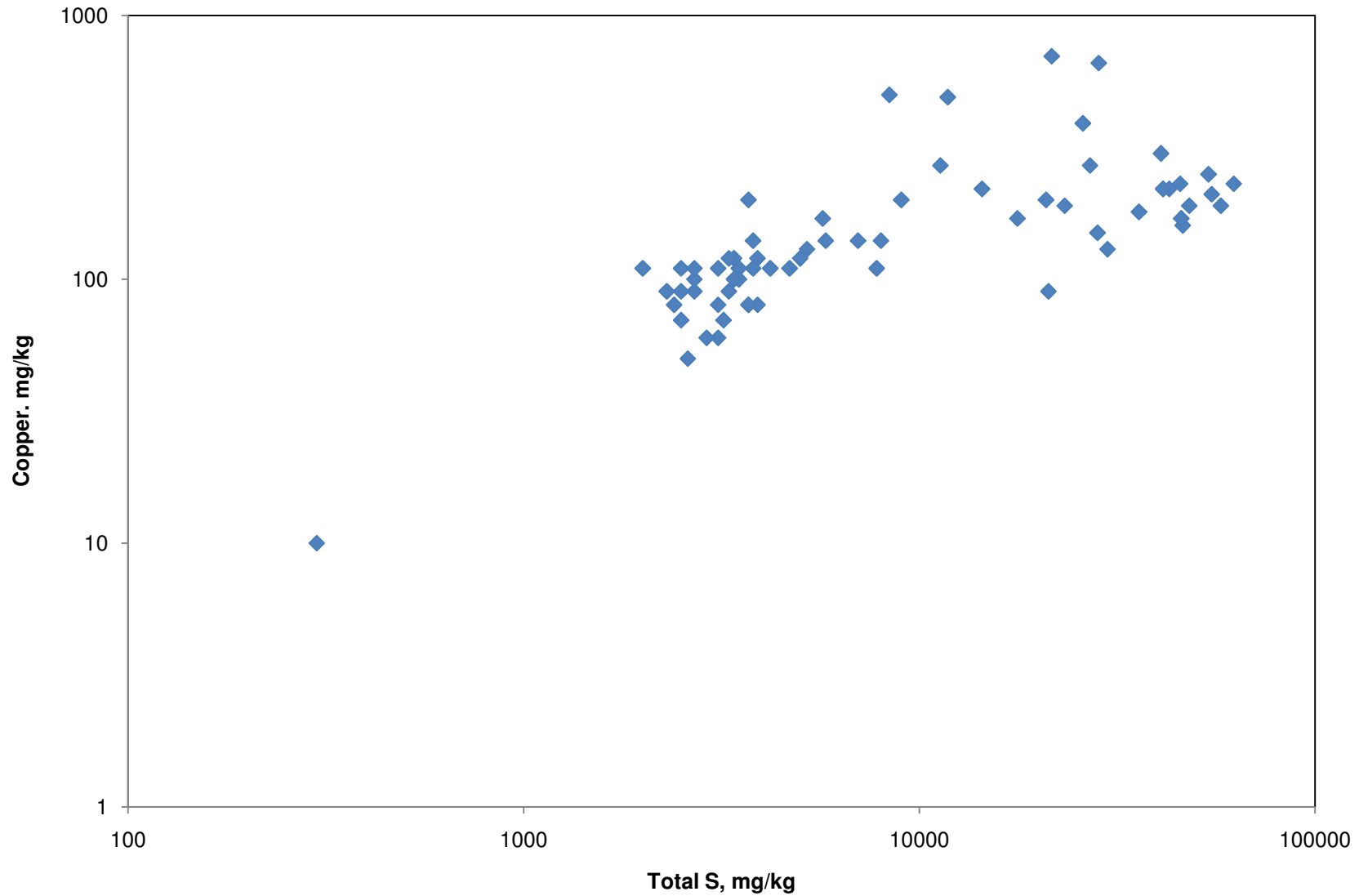

\\Van-svr0.van.na.srk.ad\ge\_projects\PolyMet Mining\1UP005.01\_Northmet\_project\_2004\Water\_Quality\_Predictions\Waste\_Rock\2011-02\_Collected\_Inputs\_for\_Modeling\Ratios\_In\_Solids\ARMetalRatios\_1UP005001\_SJD\_VER00.xls

## Virginia Formation

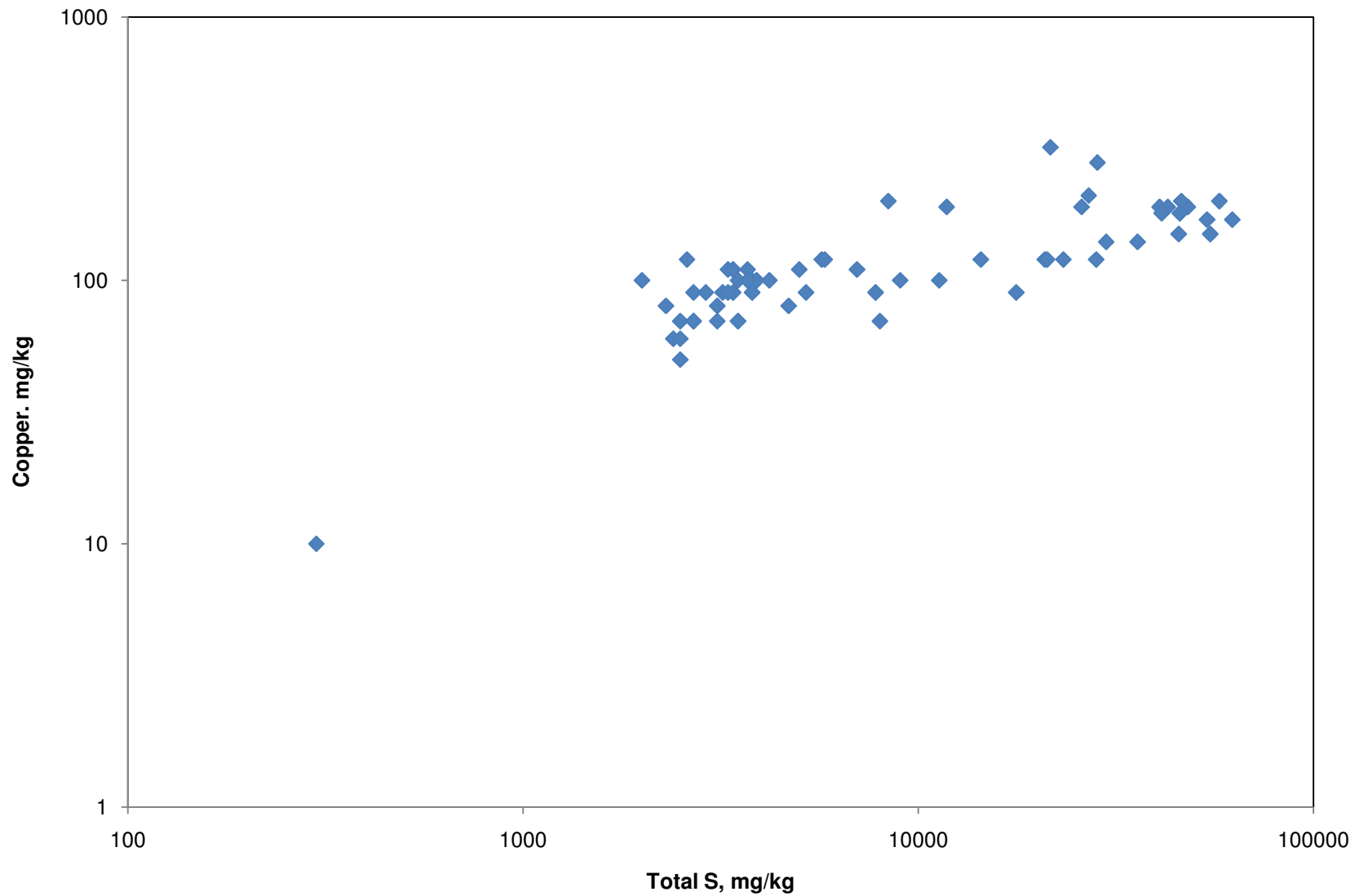

\\Van-svr0.van.na.srk.ad\ge\_projects\PolyMet Mining\1UP005.01\_Northmet\_project\_2004\Water\_Quality\_Predictions\Waste\_Rock\2011-02\_Collected\_Inputs\_for\_Modeling\Ratios\_In\_Solids\ARMetalRatios\_1UP005001\_SJD\_VER00.xls

### Virginia Formation

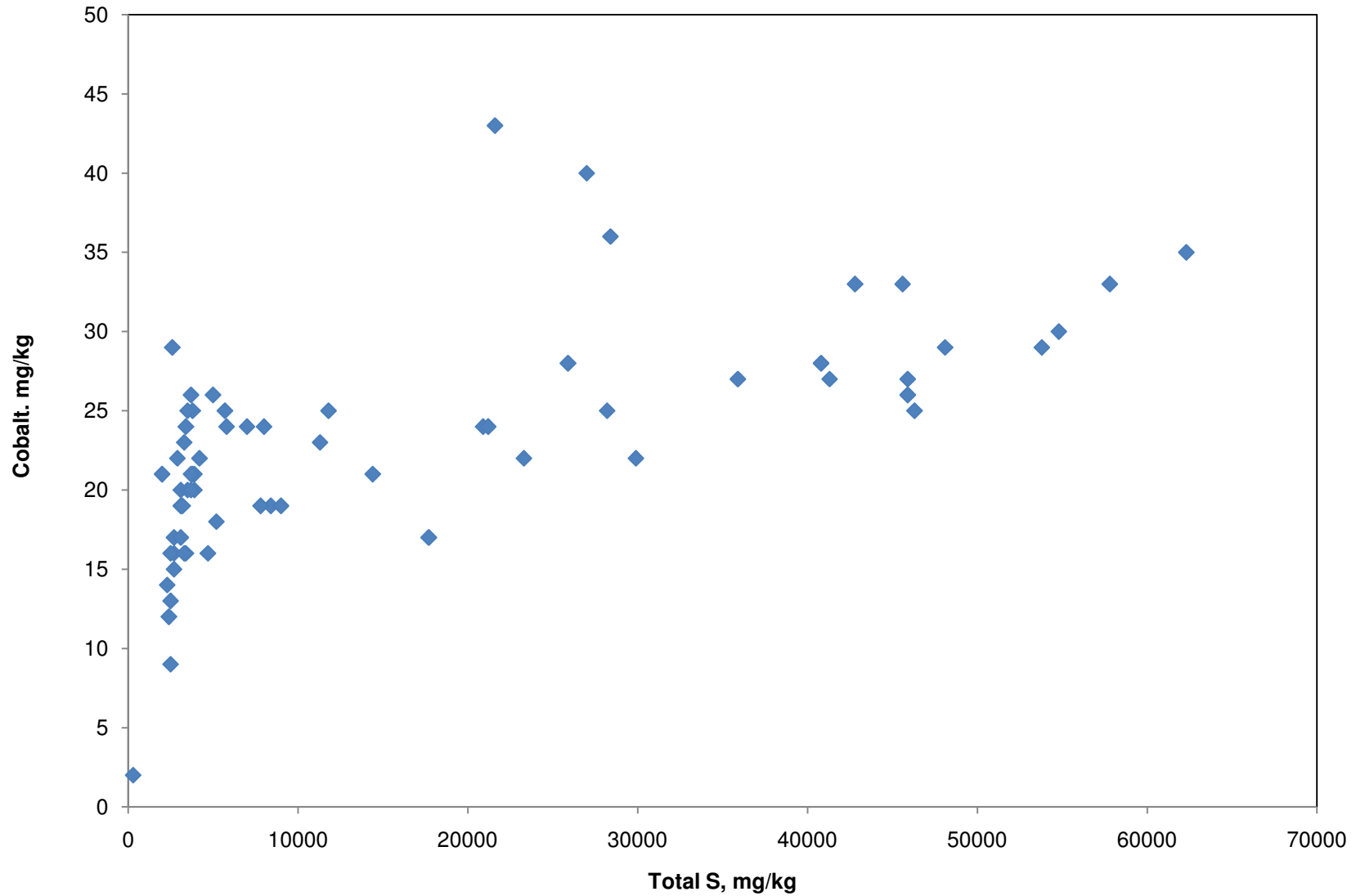

\\Van-svr0.van.na.srk.ad\ge\_projects\PolyMet Mining\1UP005.01\_Northmet\_project\_2004\Water\_Quality\_Predictions\Waste\_Rock\2011-02\_Collected\_Inputs\_for\_Modeling\Ratios\_In\_Solids\ARMetalRatios\_1UP005001\_SJD\_VER00.xls

### Virginia Formation

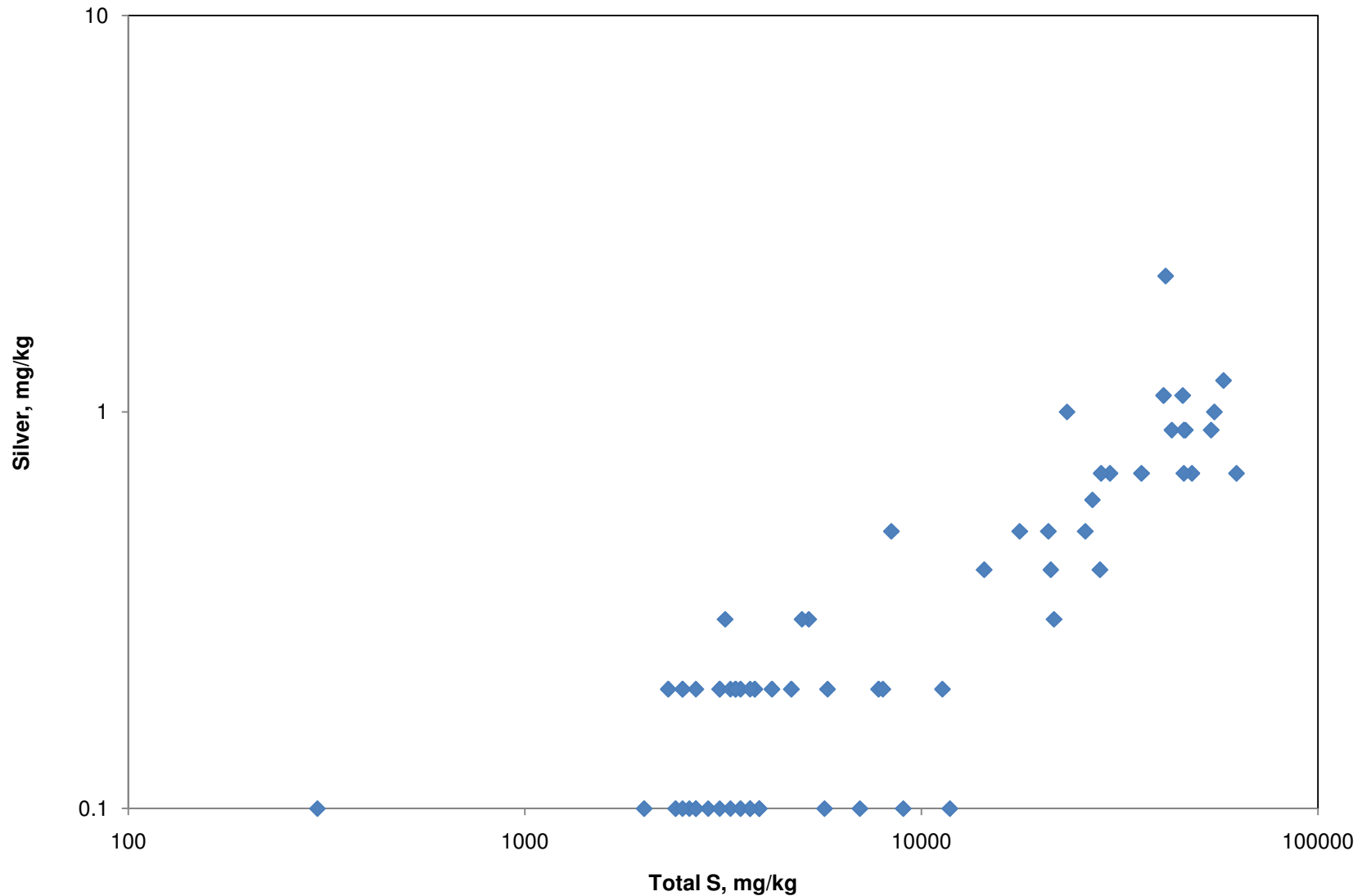

\\Van-svr0.van.na.srk.ad\ge\_projects\PolyMet Mining\1UP005.01\_Northmet\_project\_2004\Water\_Quality\_Predictions\Waste\_Rock\2011-02\_Collected\_Inputs\_for\_Modeling\Ratios\_In\_Solids\ARMetalRatios\_1UP005001\_SJD\_VER00.xls



# Virginia Formation

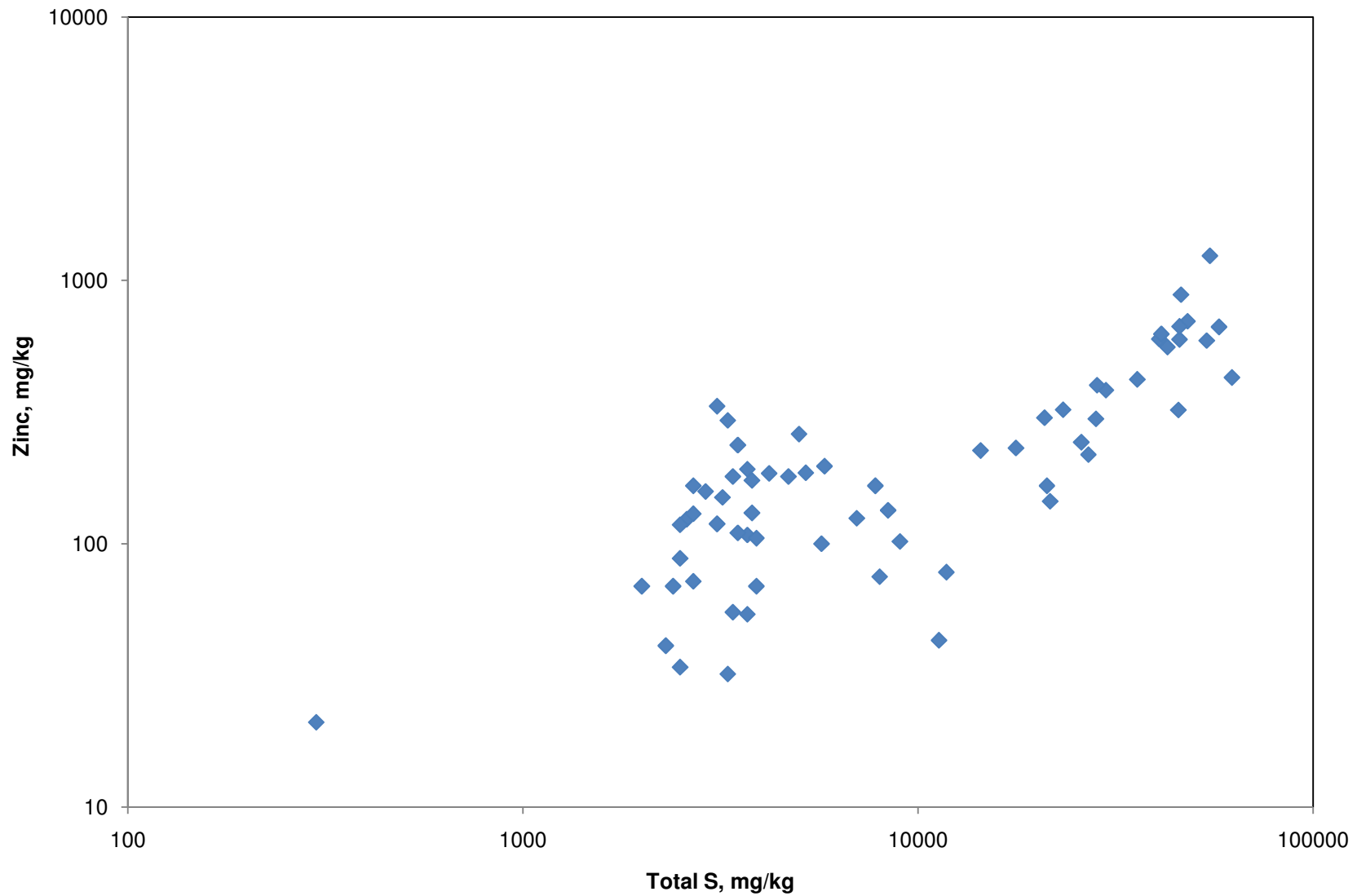

\\Van-svr0.van.na.srk.ad\ge\_projects\PolyMet Mining\1UP005.01\_Northmet\_project\_2004\Water\_Quality\_Predictions\Waste\_Rock\2011-02\_Collected\_Inputs\_for\_Modeling\Ratios\_In\_Solids\ARMetalRatios\_1UP005001\_SJD\_VER00.xls

### Virginia Formation

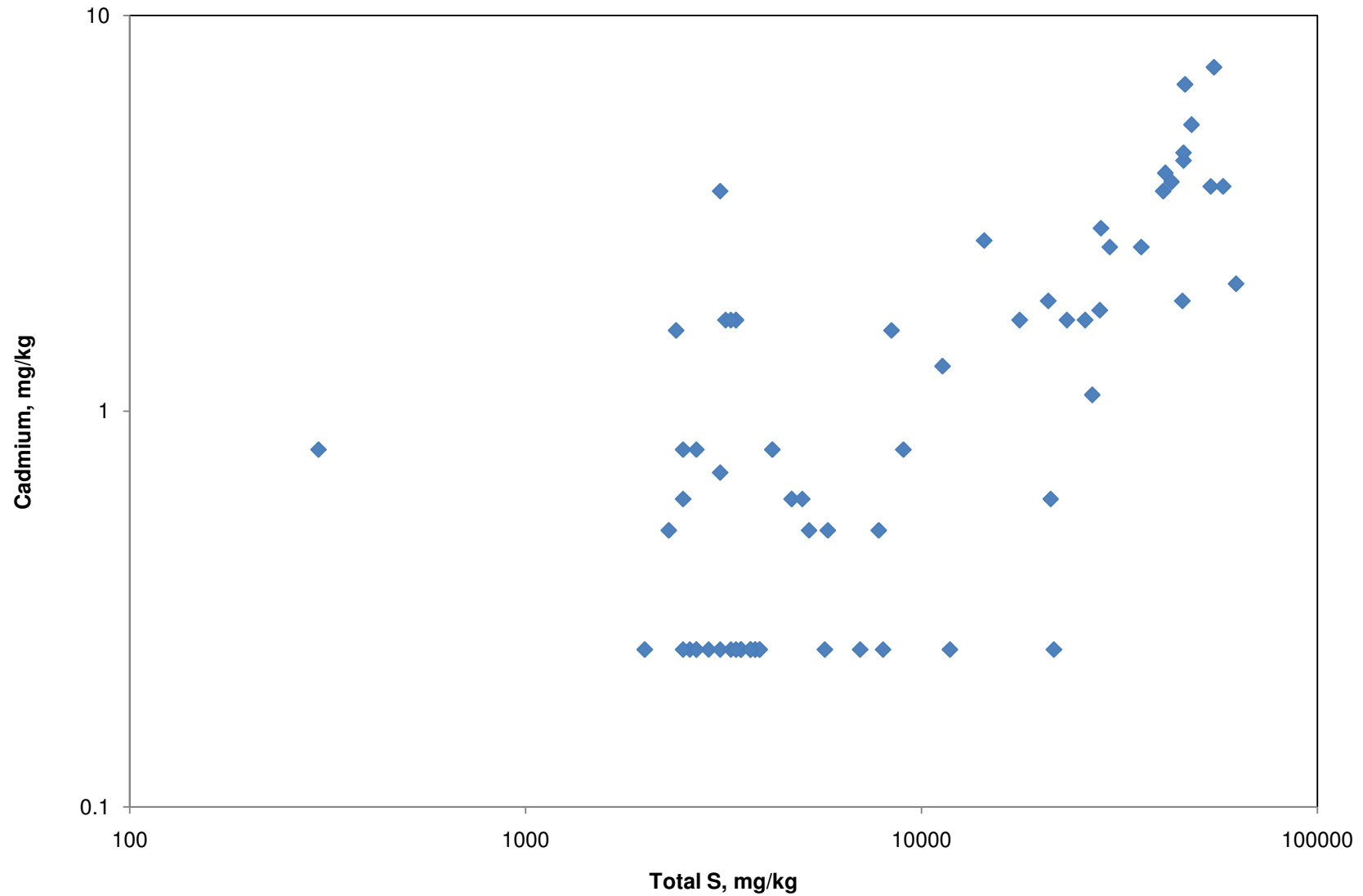

\\Van-svr0.van.na.srk.ad\ge\_projects\PolyMet Mining\1UP005.01\_Northmet\_project\_2004\Water\_Quality\_Predictions\Waste\_Rock\2011-02\_Collected\_Inputs\_for\_Modeling\Ratios\_In\_Solids\ARMetalRatios\_1UP005001\_SJD\_VER00.xls

## Virginia Formation

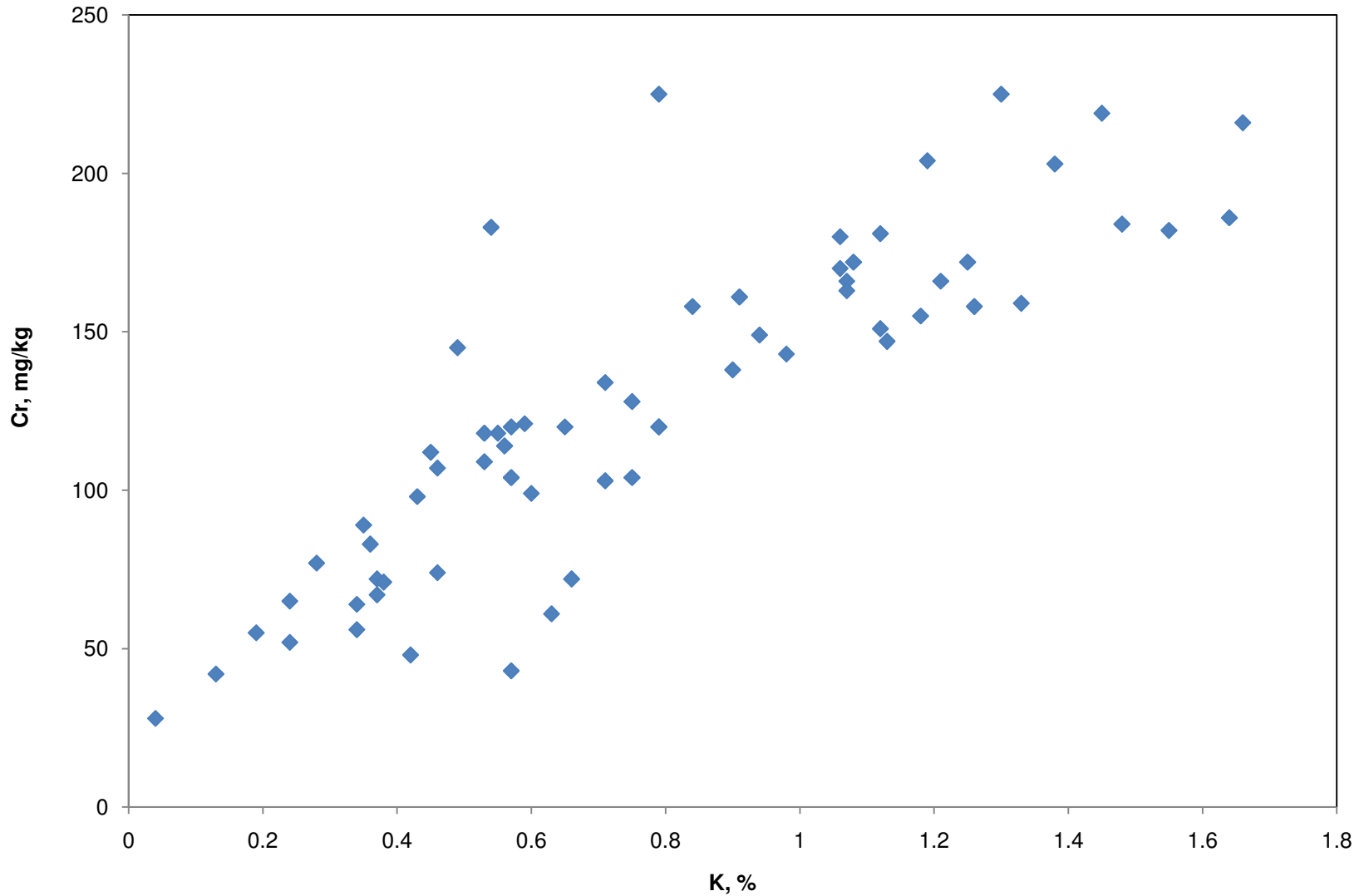

\\Van-svr0.van.na.srk.ad\ge\_projects\PolyMet Mining\1UP005.01\_Northmet\_project\_2004\Water\_Quality\_Predictions\Waste\_Rock\2011-02\_Collected\_Inputs\_for\_Modeling\Ratios\_In\_Solids\ARMetalRatios\_1UP005001\_SJD\_VER00.xls

### Virginia Formation

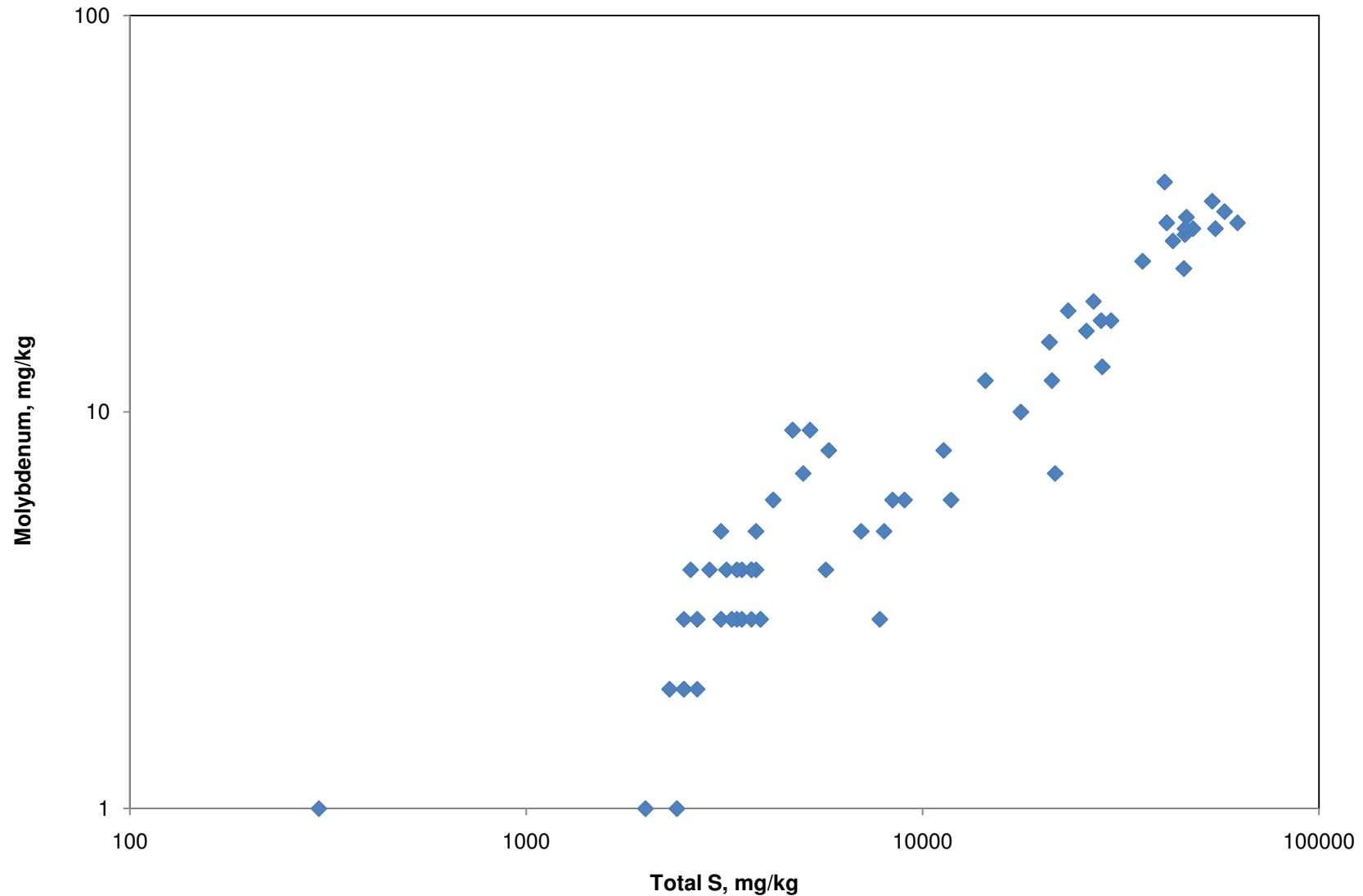

\\Van-svr0.van.na.srk.ad\ge\_projects\PolyMet Mining\1UP005.01\_Northmet\_project\_2004\Water\_Quality\_Predictions\Waste\_Rock\2011-02\_Collected\_Inputs\_for\_Modeling\Ratios\_In\_Solids\ARMetalRatios\_1UP005001\_SJD\_VER00.xls

# Virginia Formation

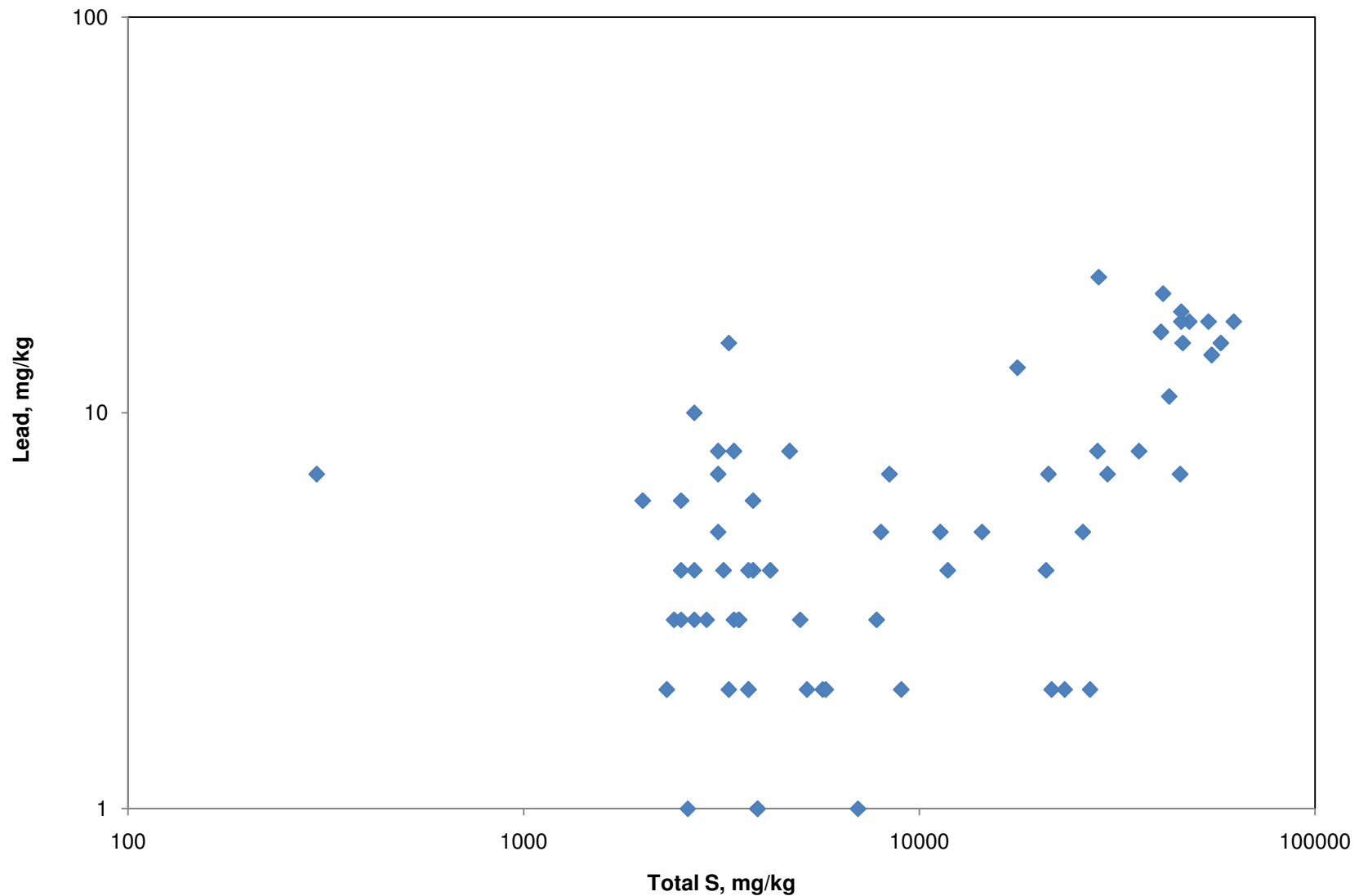

\\Van-svr0.van.na.srk.ad\ge\_projects\PolyMet Mining\1UP005.01\_Northmet\_project\_2004\Water\_Quality\_Predictions\Waste\_Rock\2011-02\_Collected\_Inputs\_for\_Modeling\Ratios\_In\_Solids\ARMetalRatios\_1UP005001\_SJD\_VER00.xls

### Virginia Formation

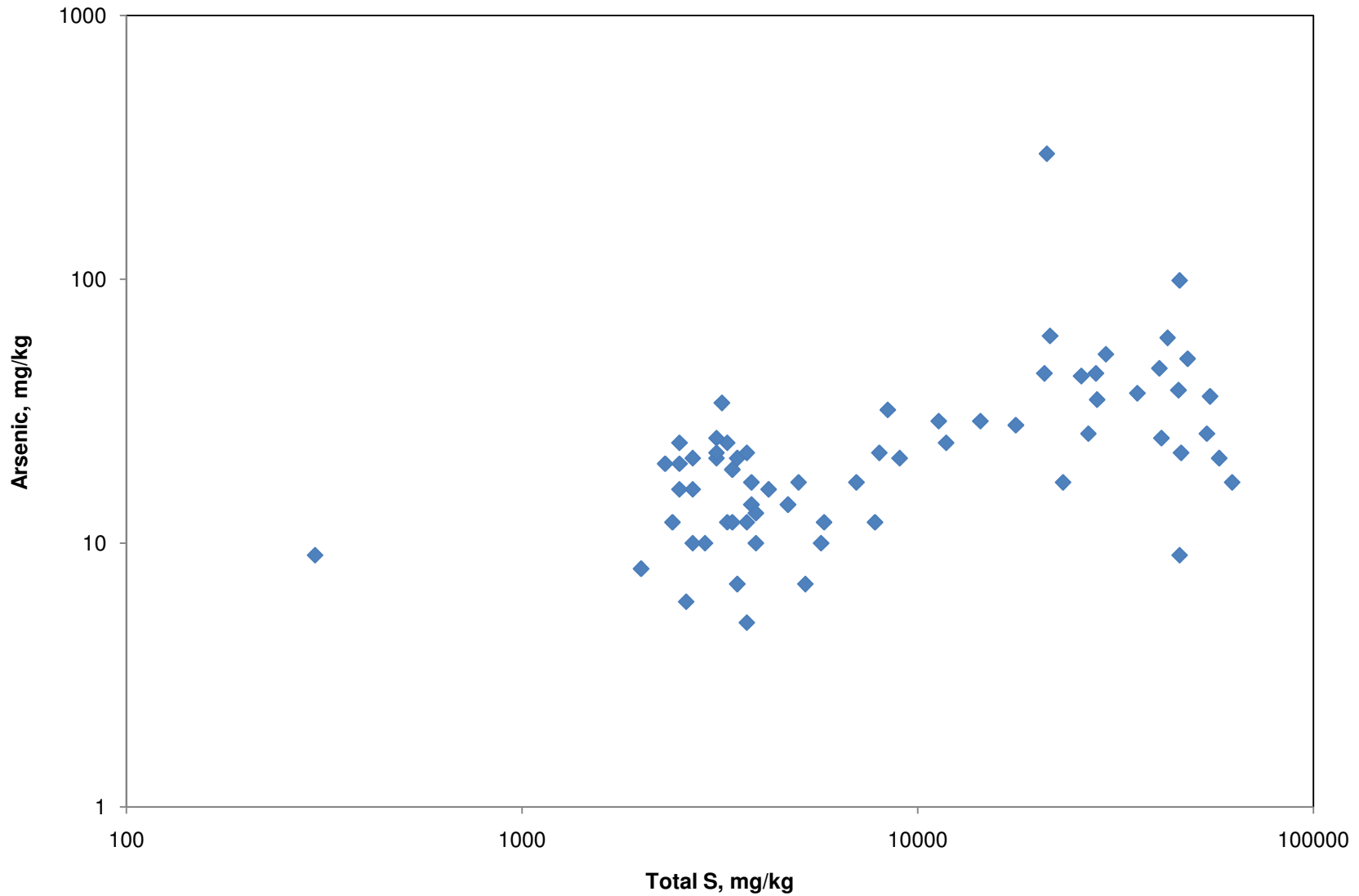

\\Van-svr0.van.na.srk.ad\ge\_projects\PolyMet Mining\1UP005.01\_Northmet\_project\_2004\Water\_Quality\_Predictions\Waste\_Rock\2011-02\_Collected\_Inputs\_for\_Modeling\Ratios\_In\_Solids\ARMetalRatios\_1UP005001\_SJD\_VER00.xls

### Virginia Formation

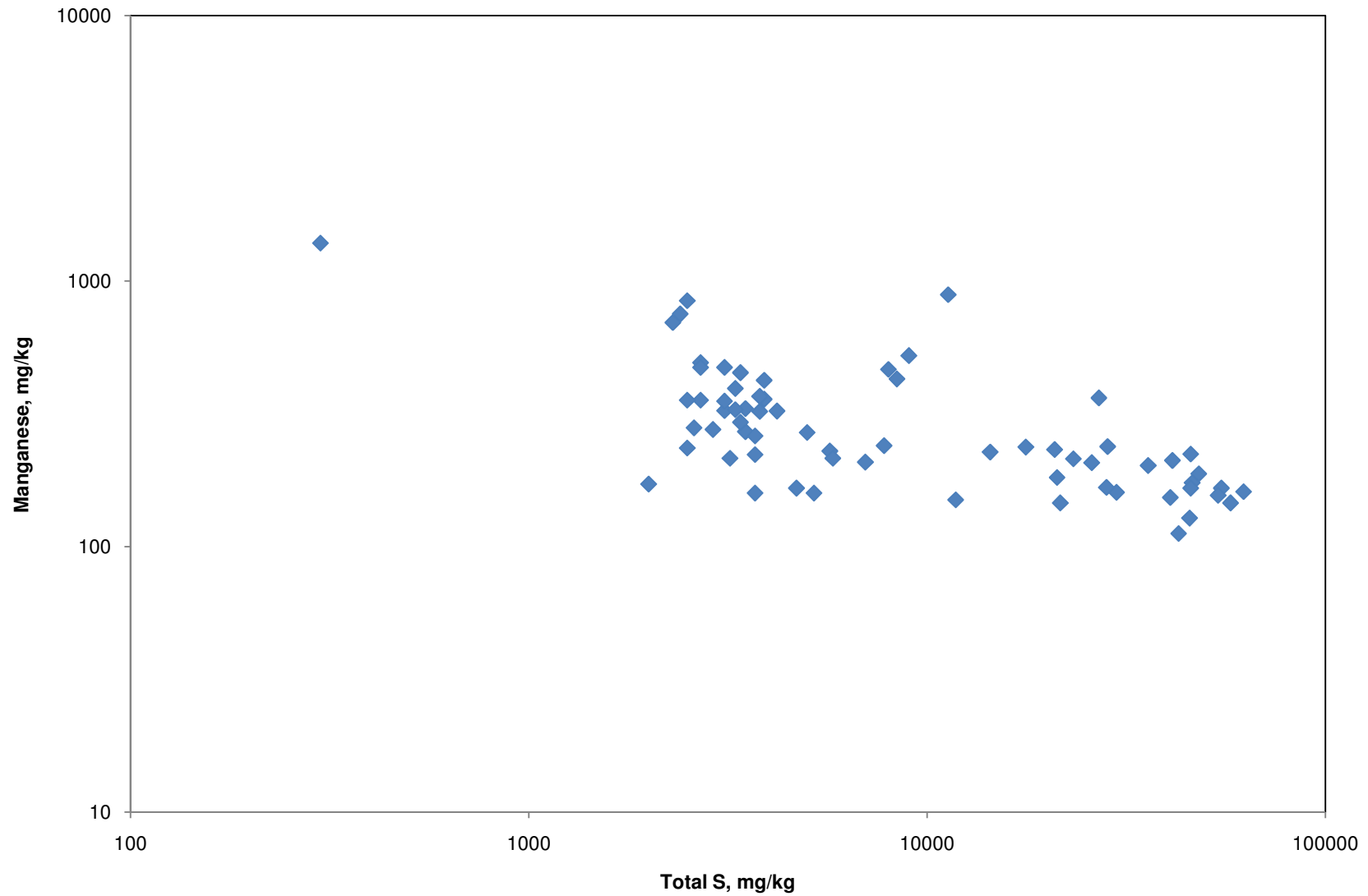

\\Van-svr0.van.na.srk.ad\ge\_projects\PolyMet Mining\1UP005.01\_Northmet\_project\_2004\Water\_Quality\_Predictions\Waste\_Rock\2011-02\_Collected\_Inputs\_for\_Modeling\Ratios\_In\_Solids\ARMetalRatios\_1UP005001\_SJD\_VER00.xls

**Attachment 2**  
**Trend Analysis for Rock Humidity Cells**



**a. Category 1**

# 99-320C(830-850)

Waste Category:	1
Rock Type:	Anorthositic
Geology:	Duluth Complex
Sulfur:	0.09%

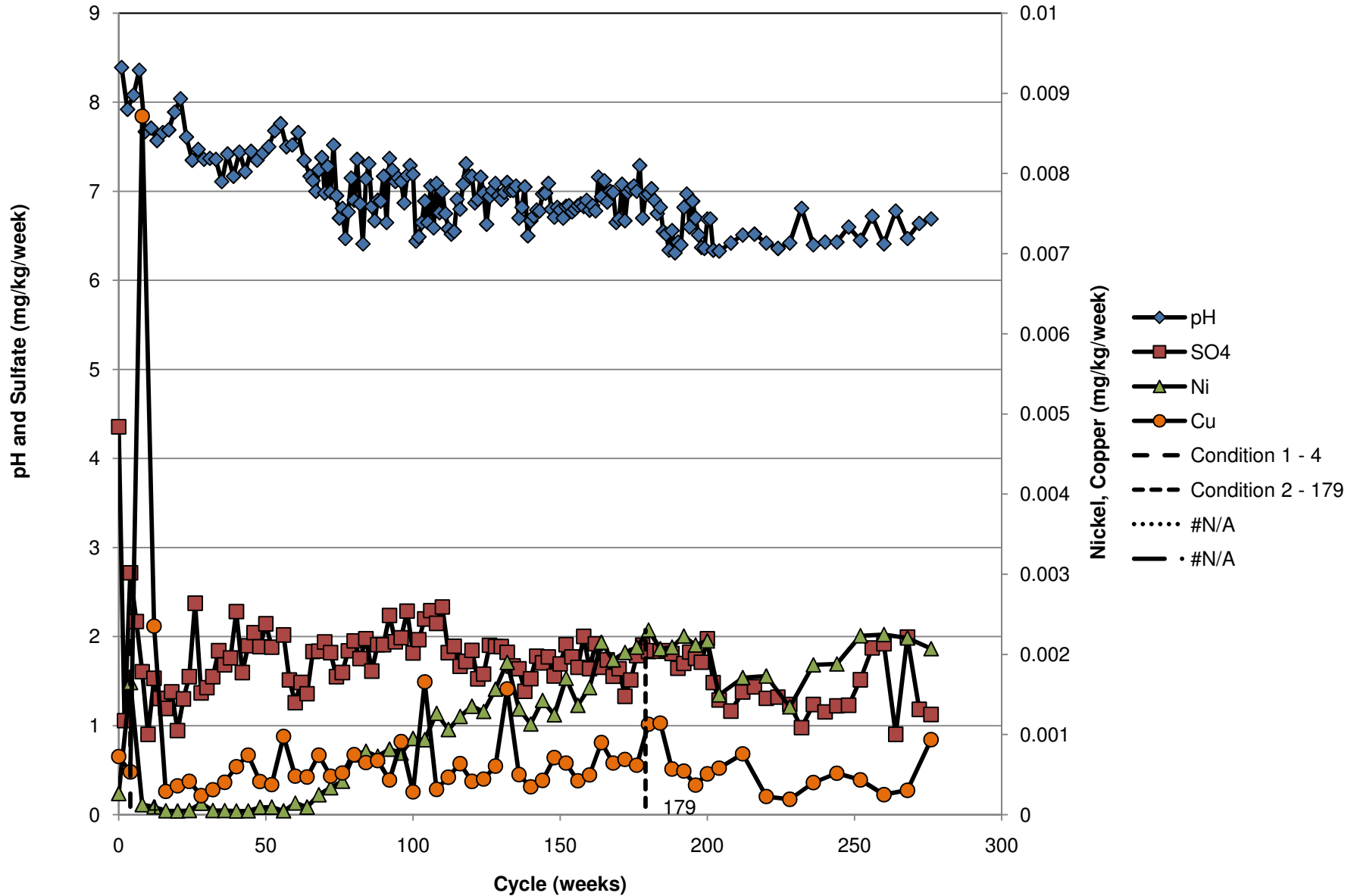

# 00-361C(345-350)

Waste Category:	1
Rock Type:	Anorthositic
Geology:	Duluth Complex
Sulfur:	0.05%

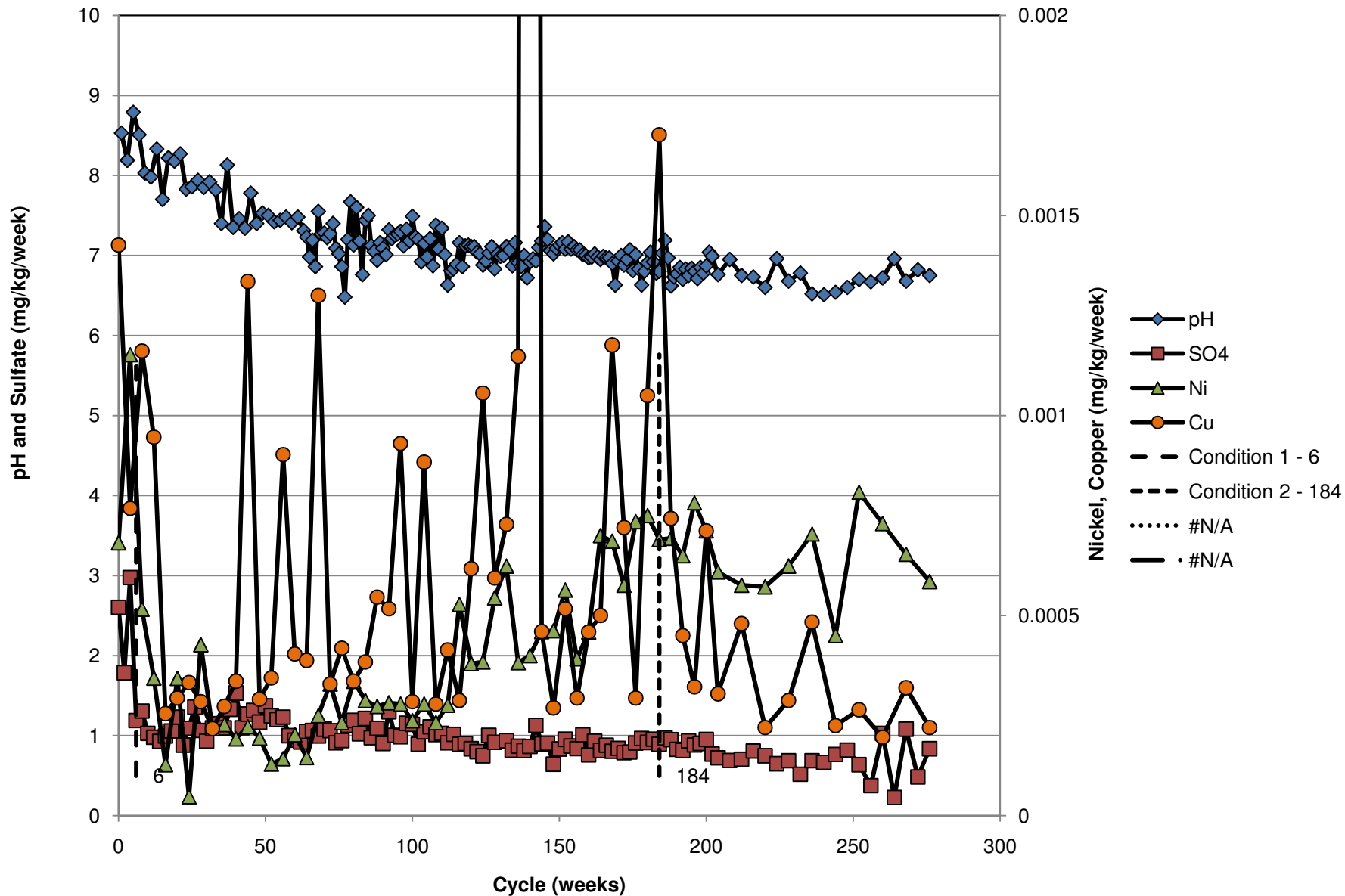

# 00-334C(30-50)

Waste Category:	1
Rock Type:	Anorthositic
Geology:	Duluth Complex
Sulfur:	0.02%

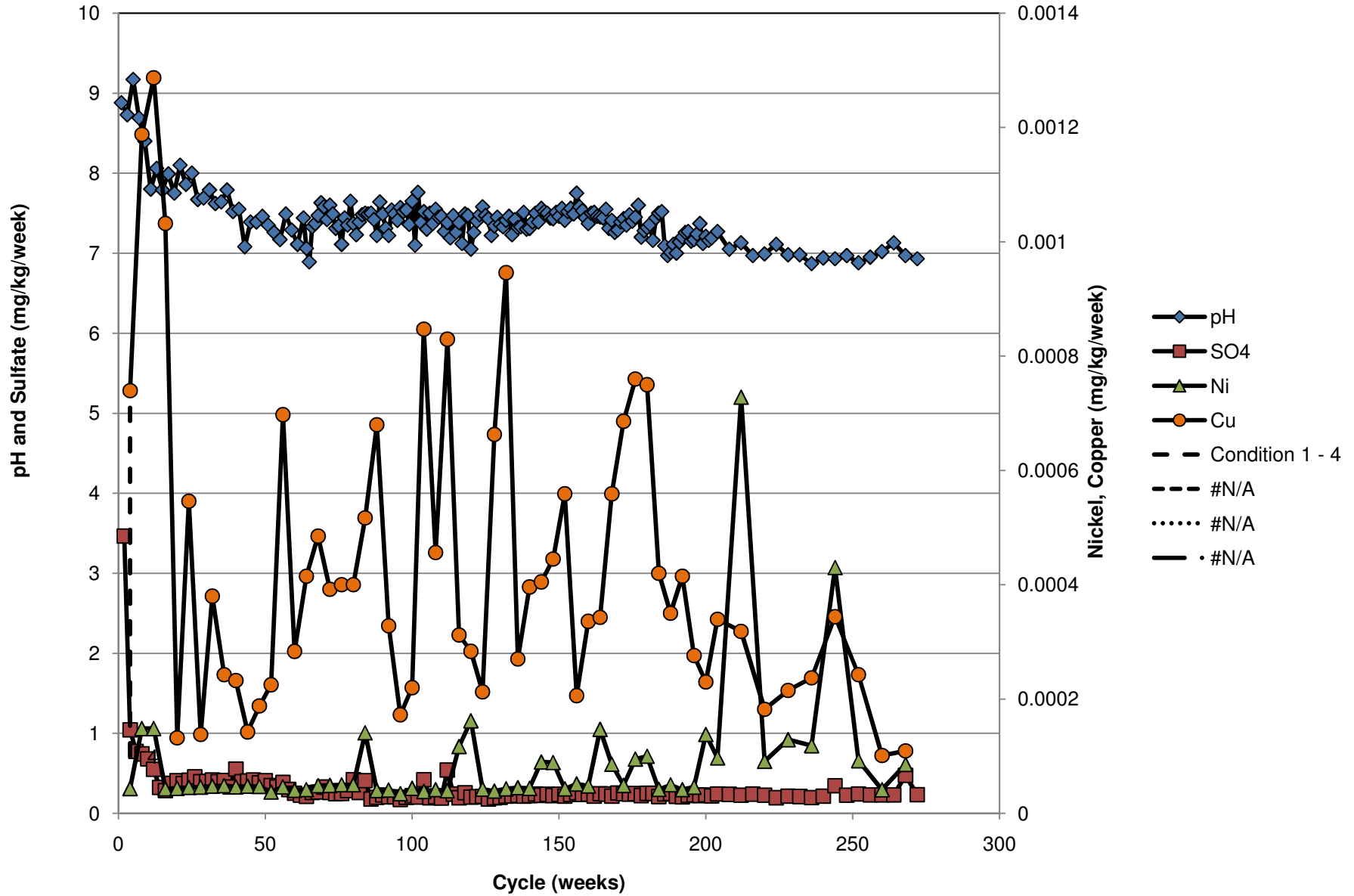

# 00-366C(185-205)

Waste Category: 1  
Rock Type: Anorthositic  
Geology: Duluth Complex  
Sulfur: 0.02%

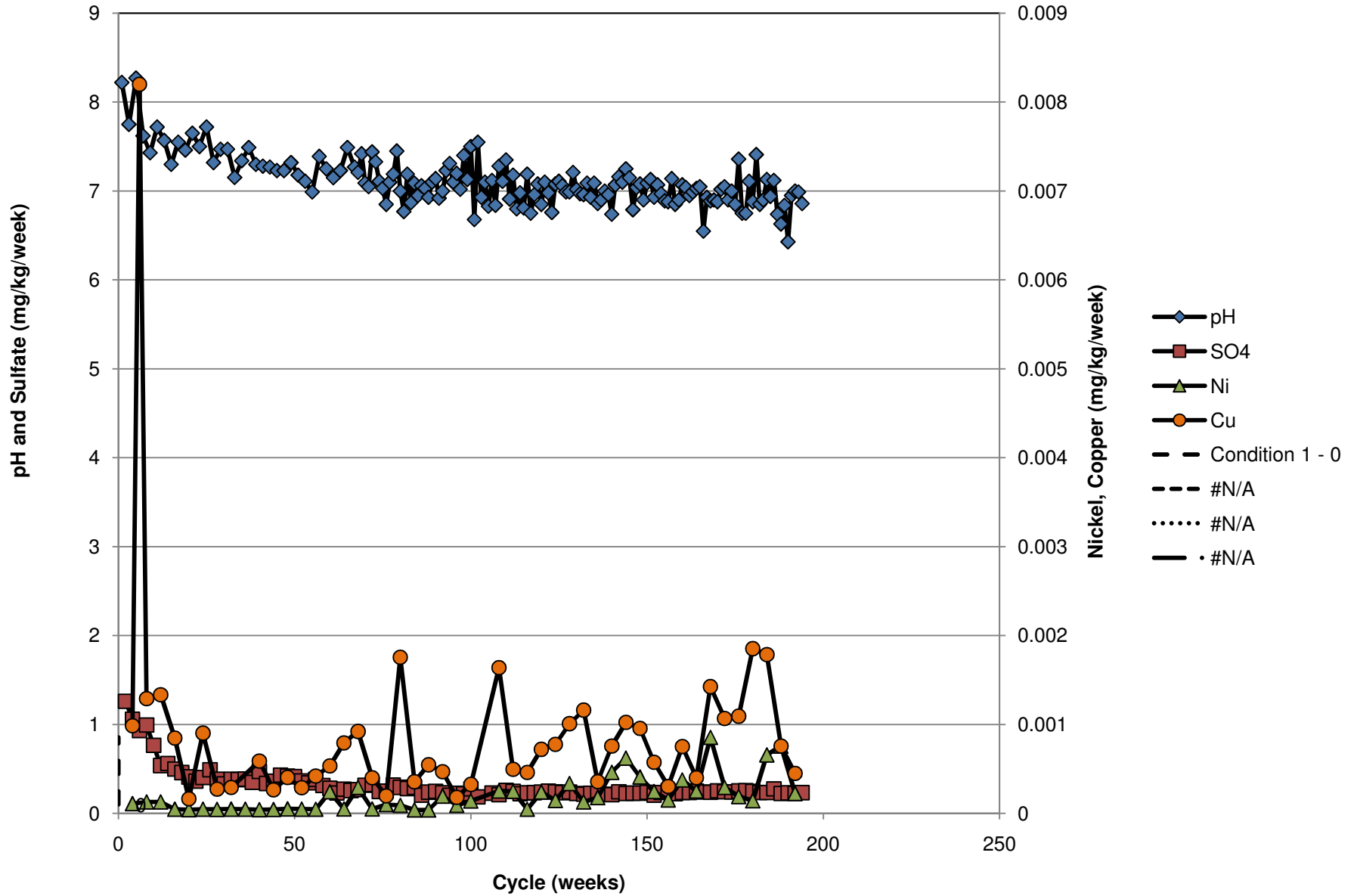

# 00-366C(230-240)

Waste Category:	1
Rock Type:	Anorthositic
Geology:	Duluth Complex
Sulfur:	0.02%

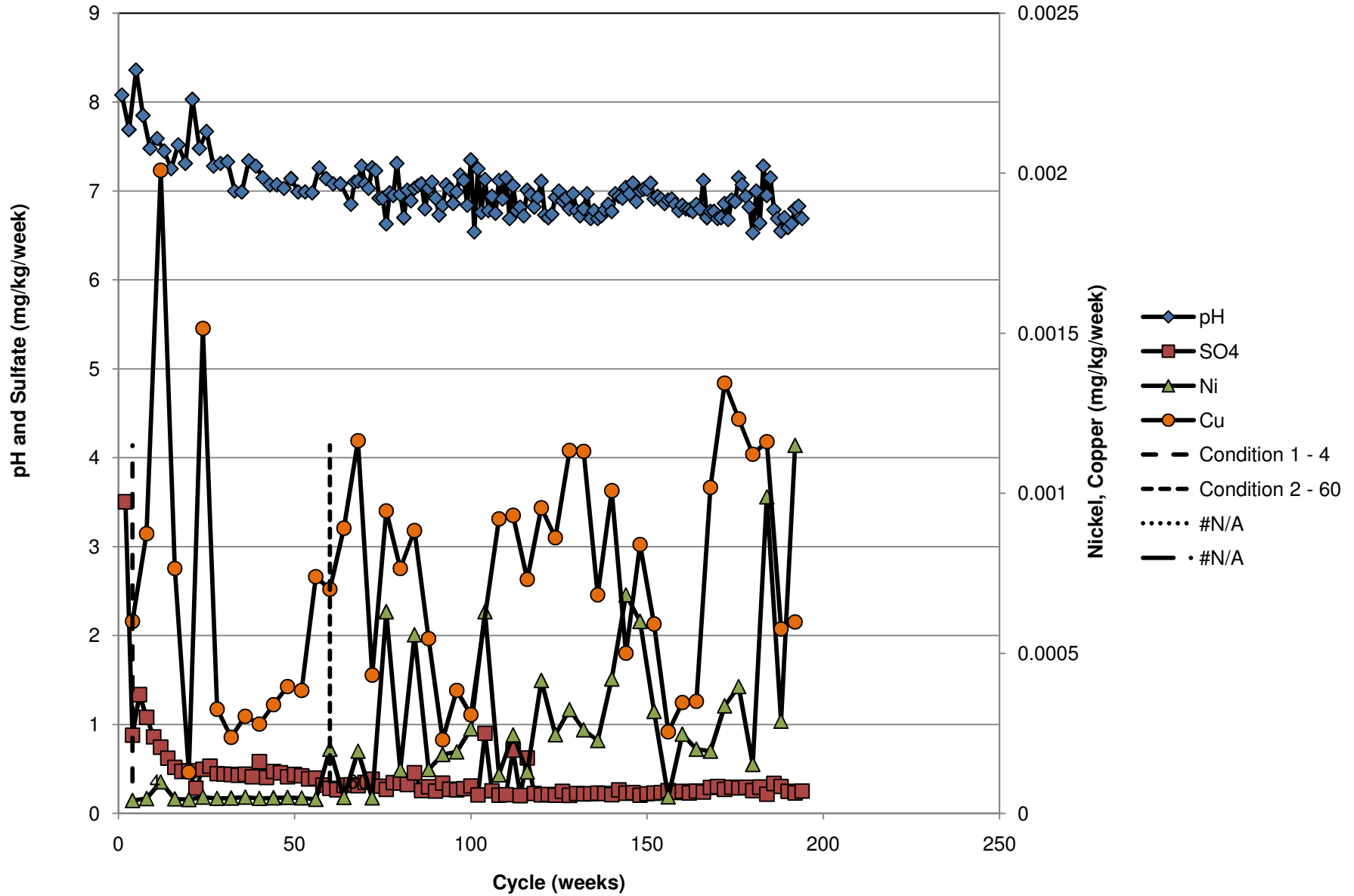

Waste Category:	1
Rock Type:	Anorthositic
Geology:	Duluth Complex
Sulfur:	0.03%

### 99-320C(165-175)

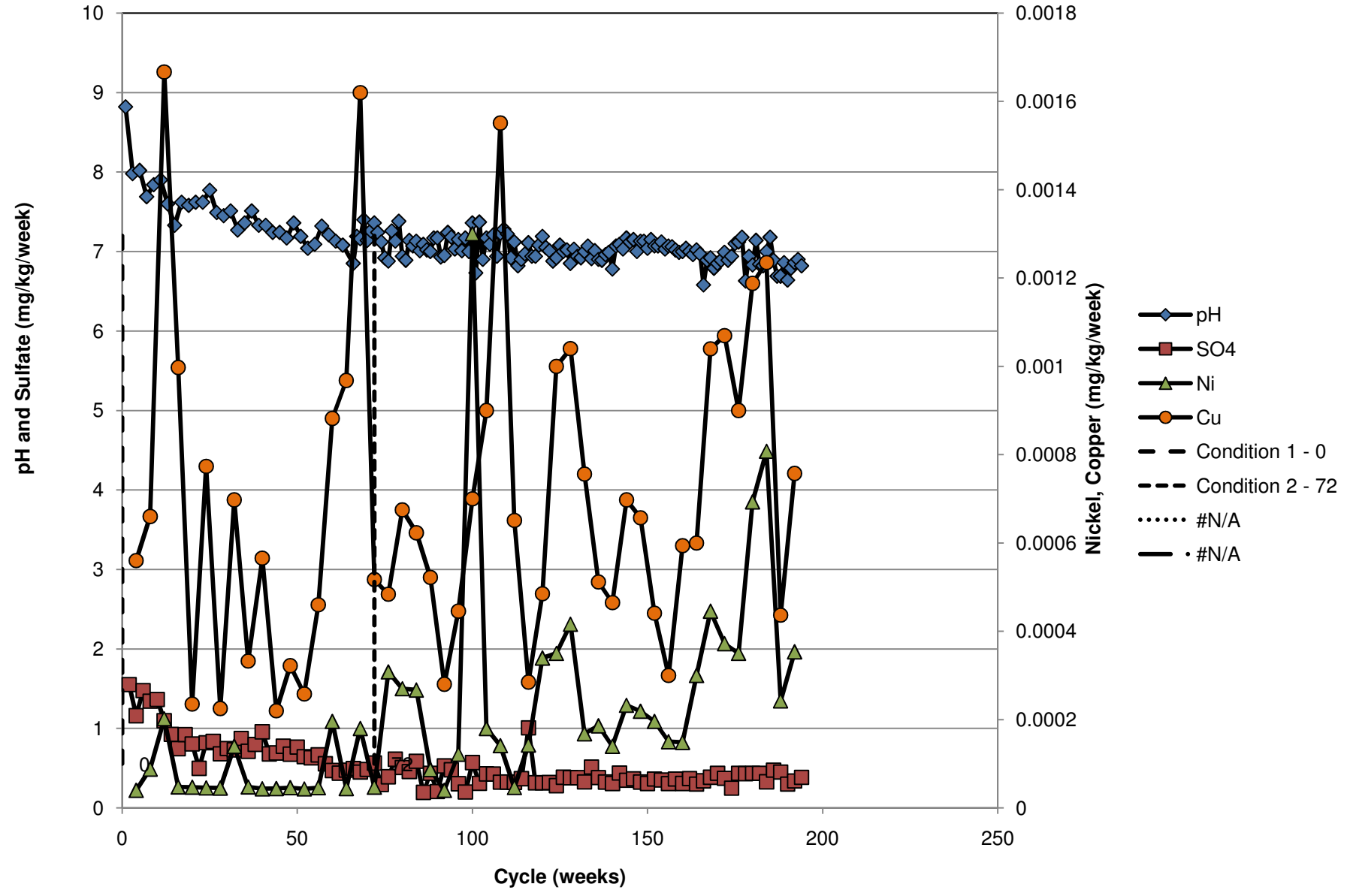

# 00-368C(125-145)

Waste Category:	1
Rock Type:	Anorthositic
Geology:	Duluth Complex
Sulfur:	0.04%

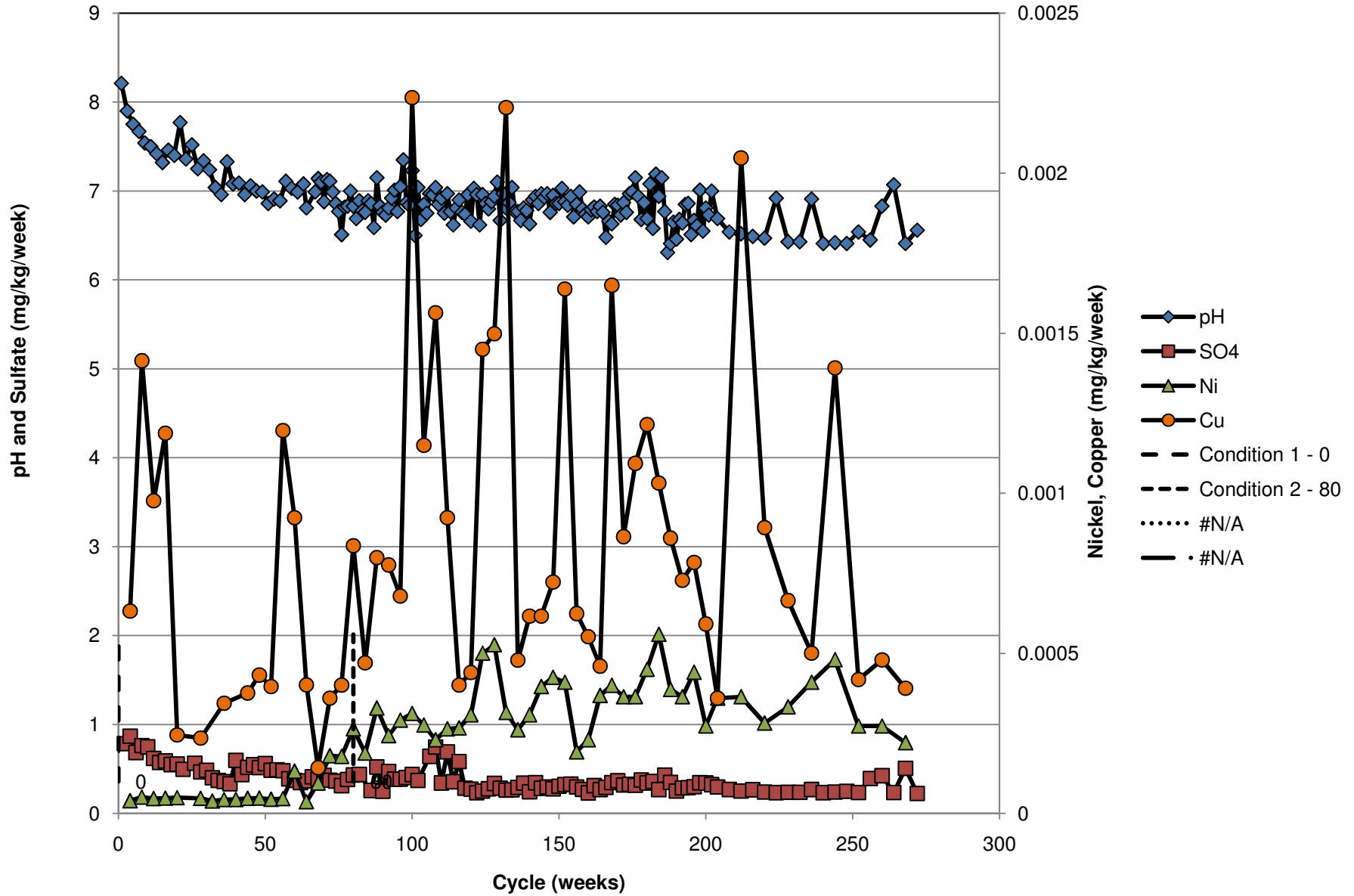



Waste Category:	1
Rock Type:	Anorthositic
Geology:	Duluth Complex
Sulfur:	0.04%

### 00-368C(20-40)

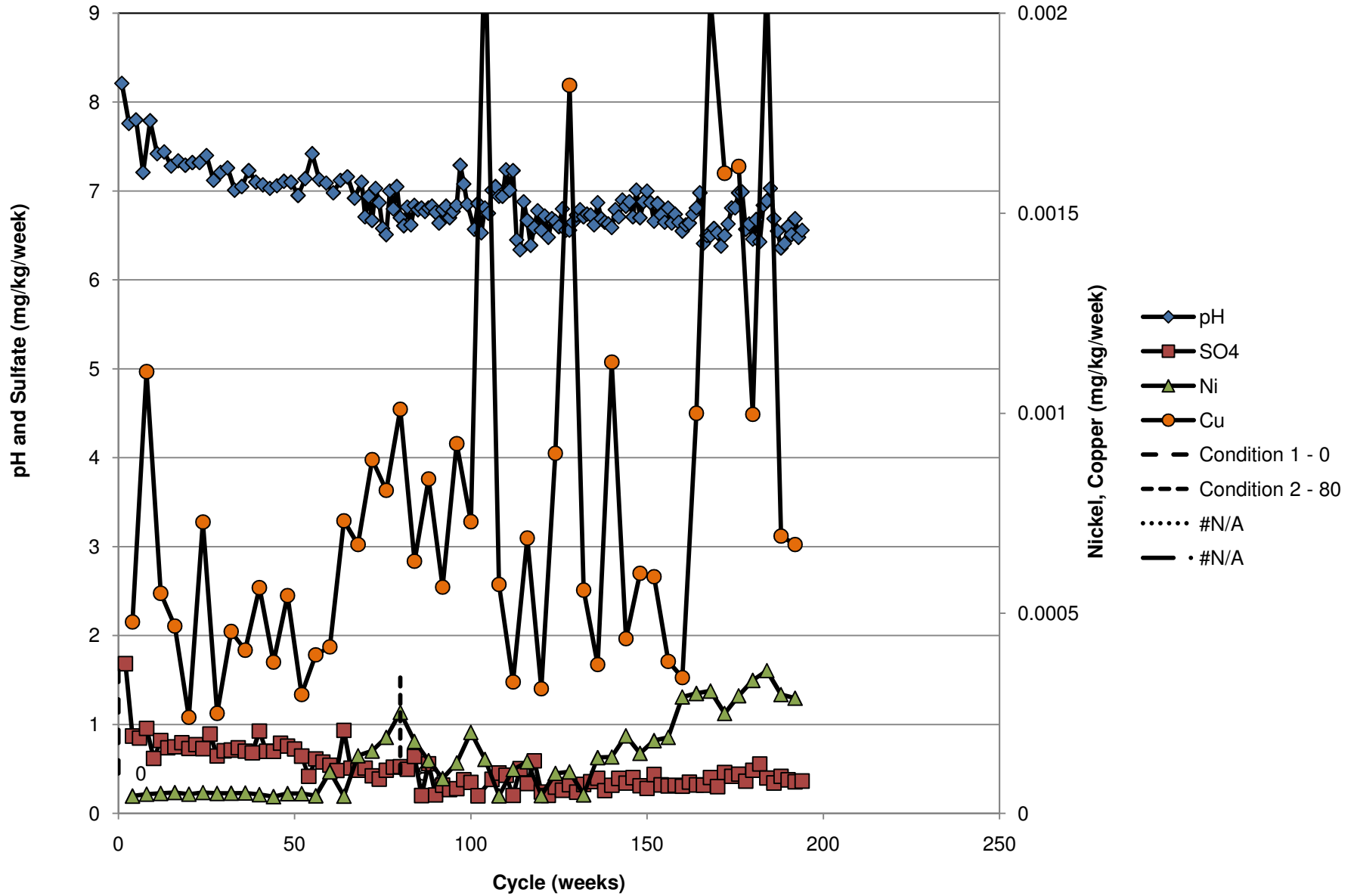

# 00-334C(580-600)

Waste Category:	1
Rock Type:	Troctolitic
Geology:	Duluth Complex
Sulfur:	0.06%

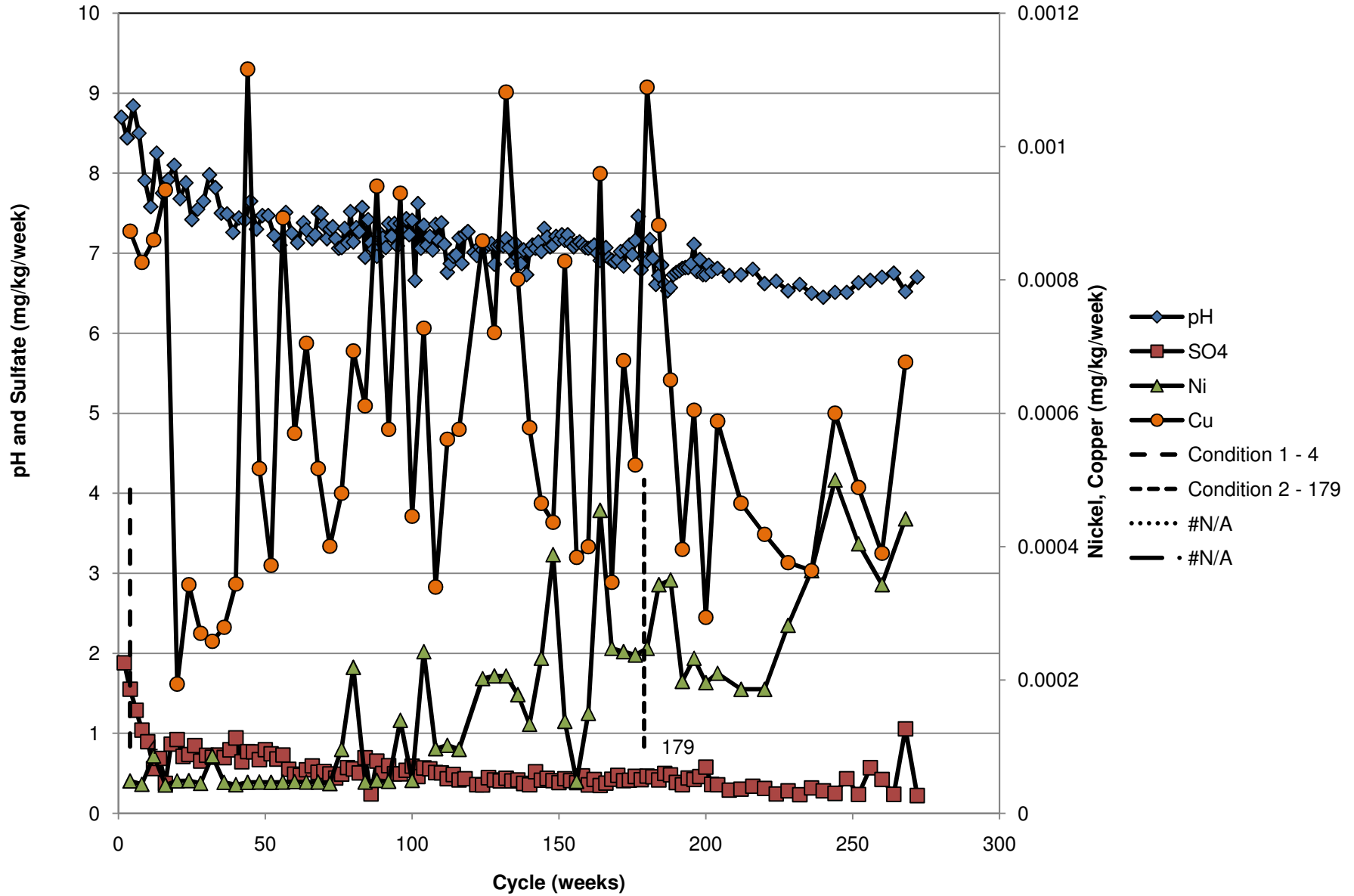

# 00-334C(640-660)

Waste Category:	1
Rock Type:	Troctolitic
Geology:	Duluth Complex
Sulfur:	0.07%

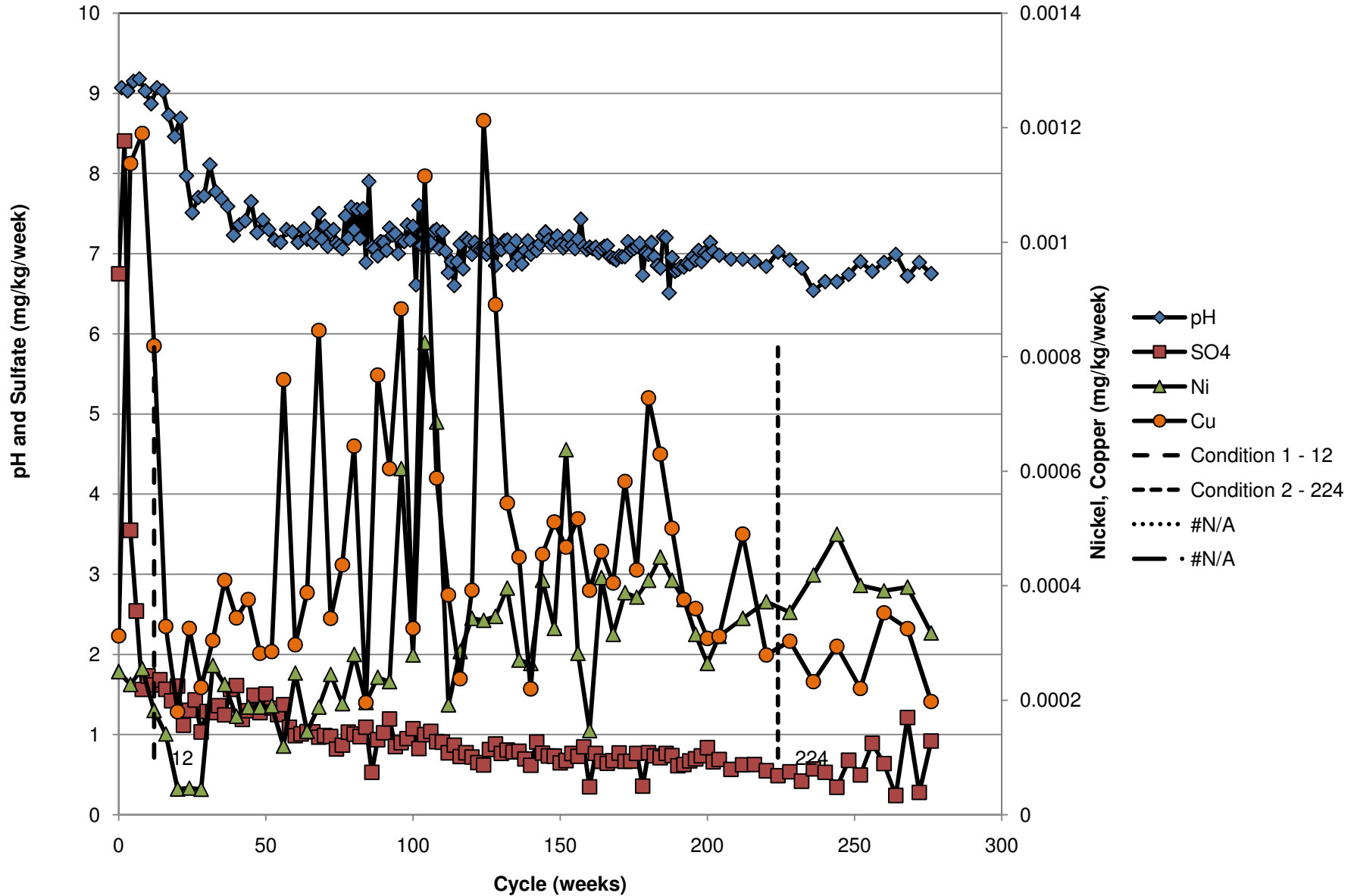

# 99-320C(315-330)

Waste Category:	1
Rock Type:	Troctolitic
Geology:	Duluth Complex
Sulfur:	0.07%

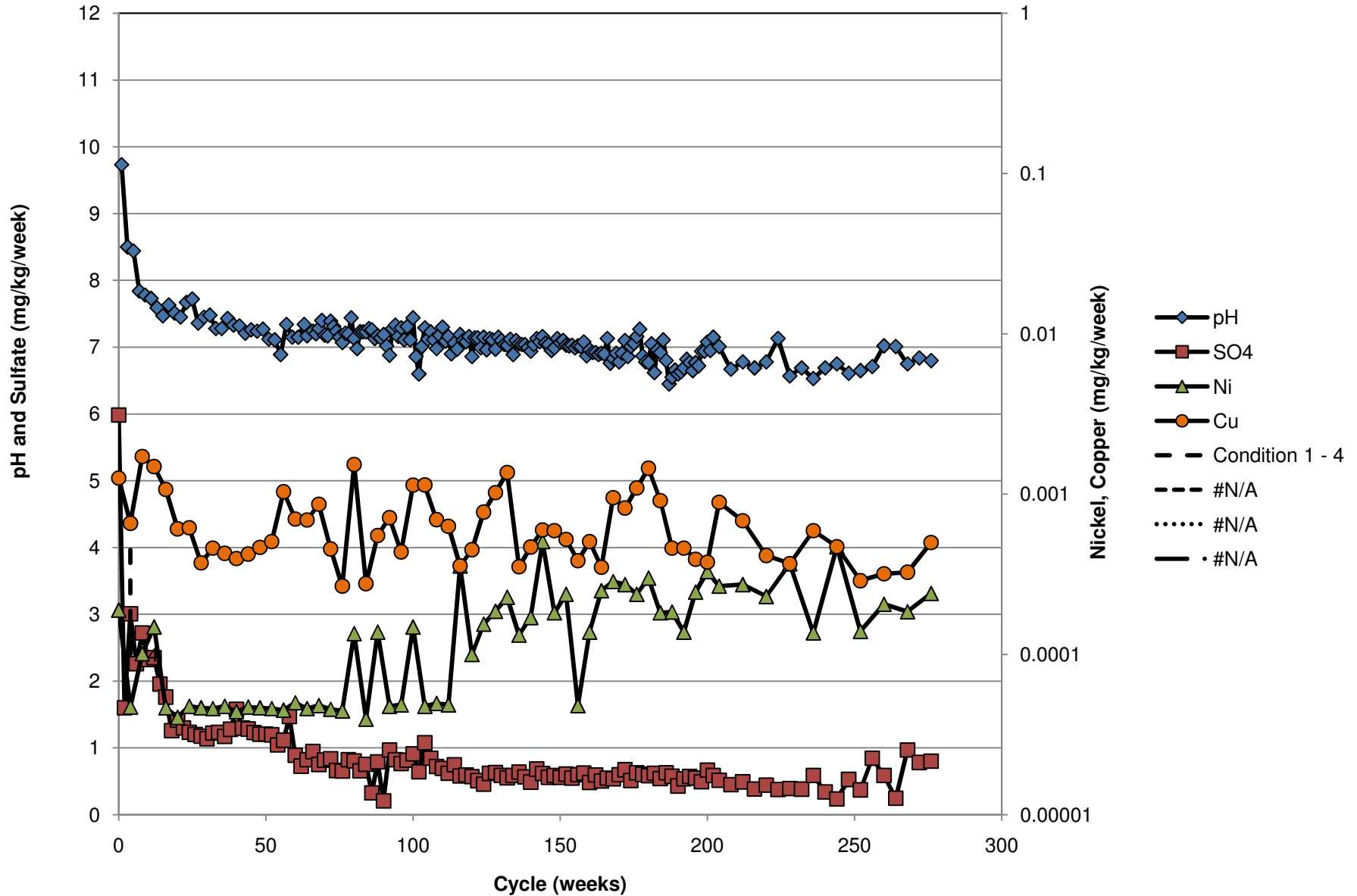

# 00-367C(290-310)

Waste Category:	1
Rock Type:	Troctolitic
Geology:	Duluth Complex
Sulfur:	0.04%

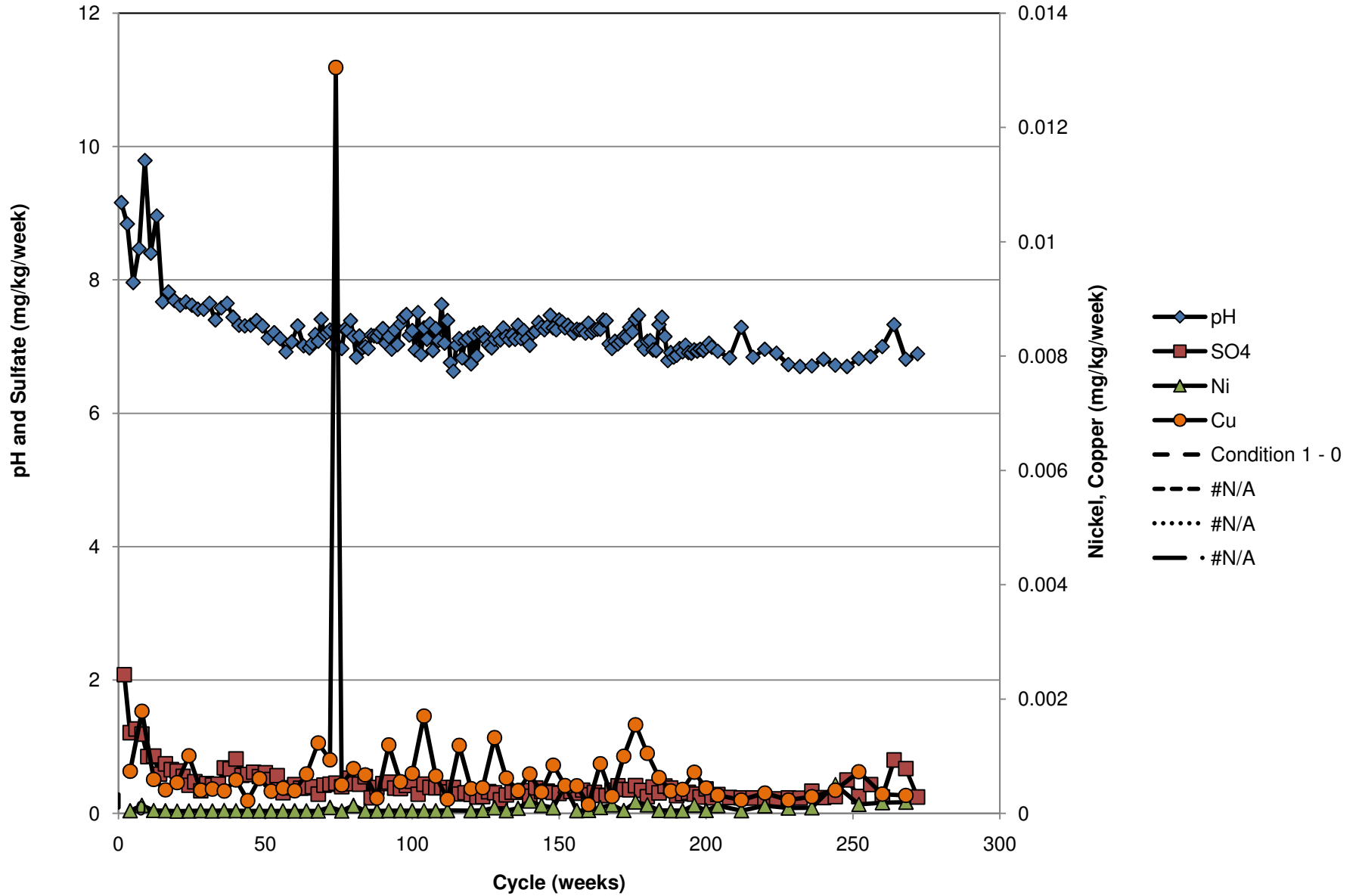

# 26064(44-54)

Waste Category:	1
Rock Type:	Troctolitic
Geology:	Duluth Complex
Sulfur:	0.02%

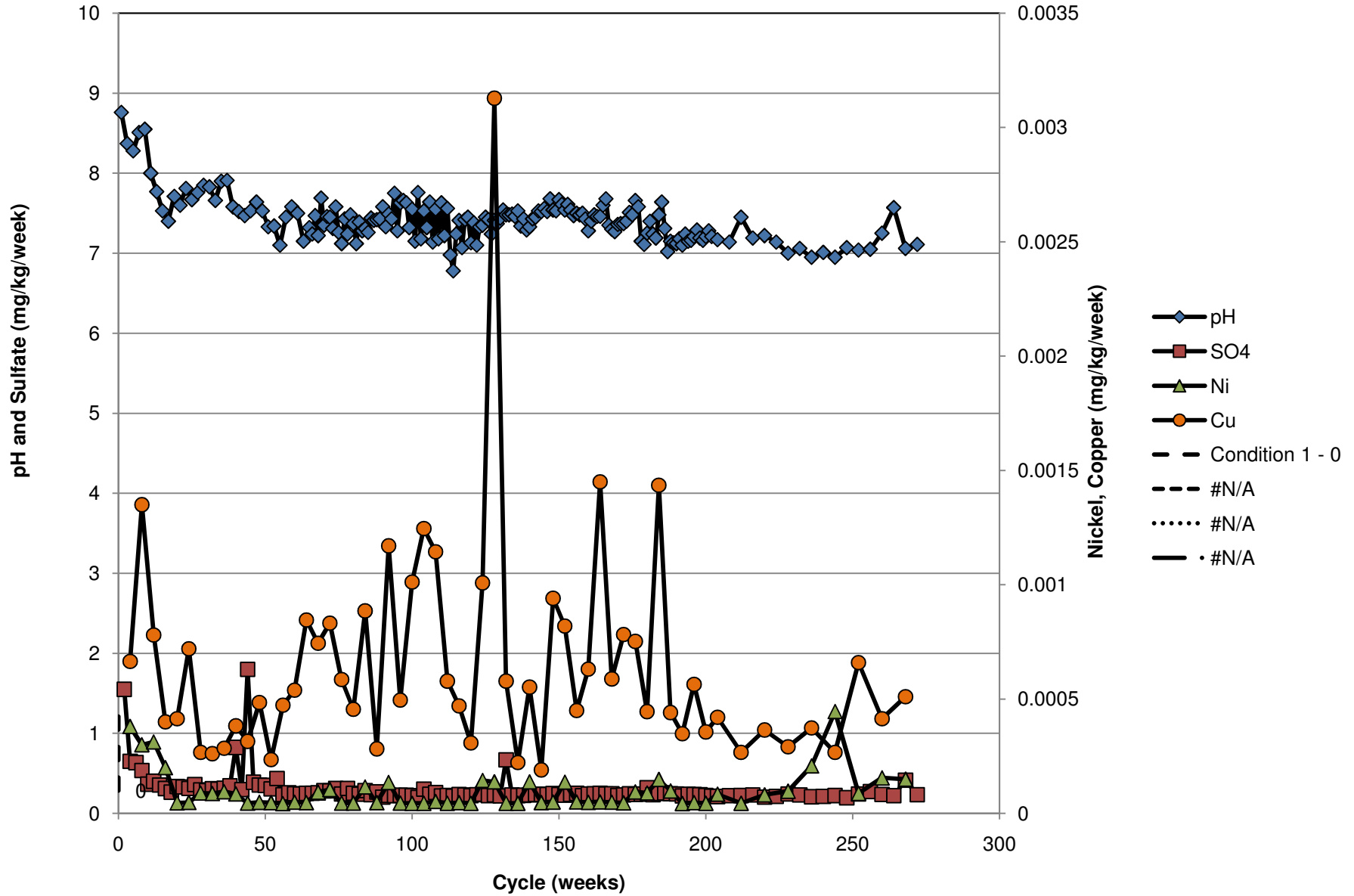

# 26064(264+146-269+156)

Waste Category:	1
Rock Type:	Troctolitic
Geology:	Duluth Complex
Sulfur:	0.06%

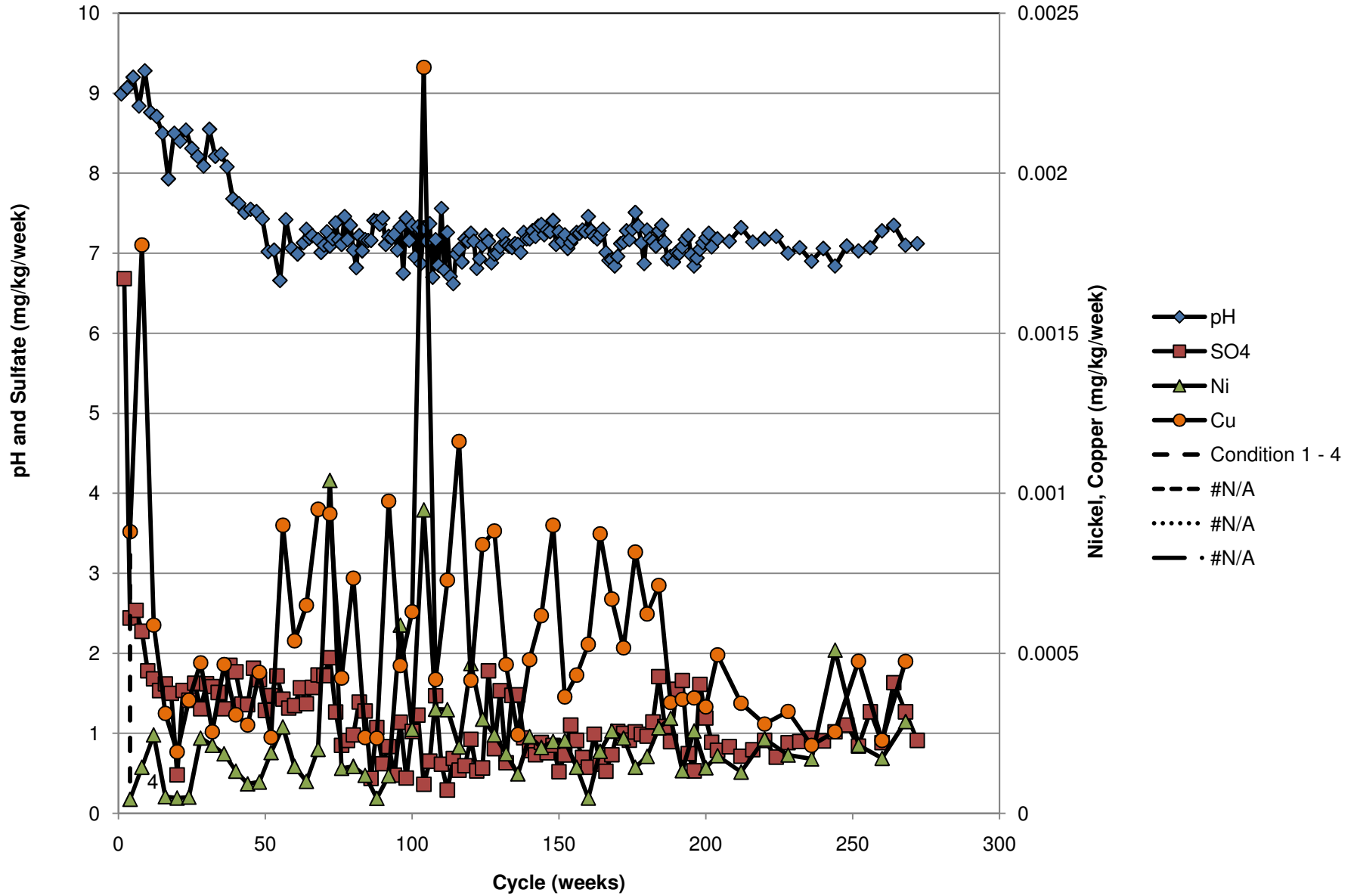

# 26056(135-153)

Waste Category:	1
Rock Type:	Troctolitic
Geology:	Duluth Complex
Sulfur:	0.05%

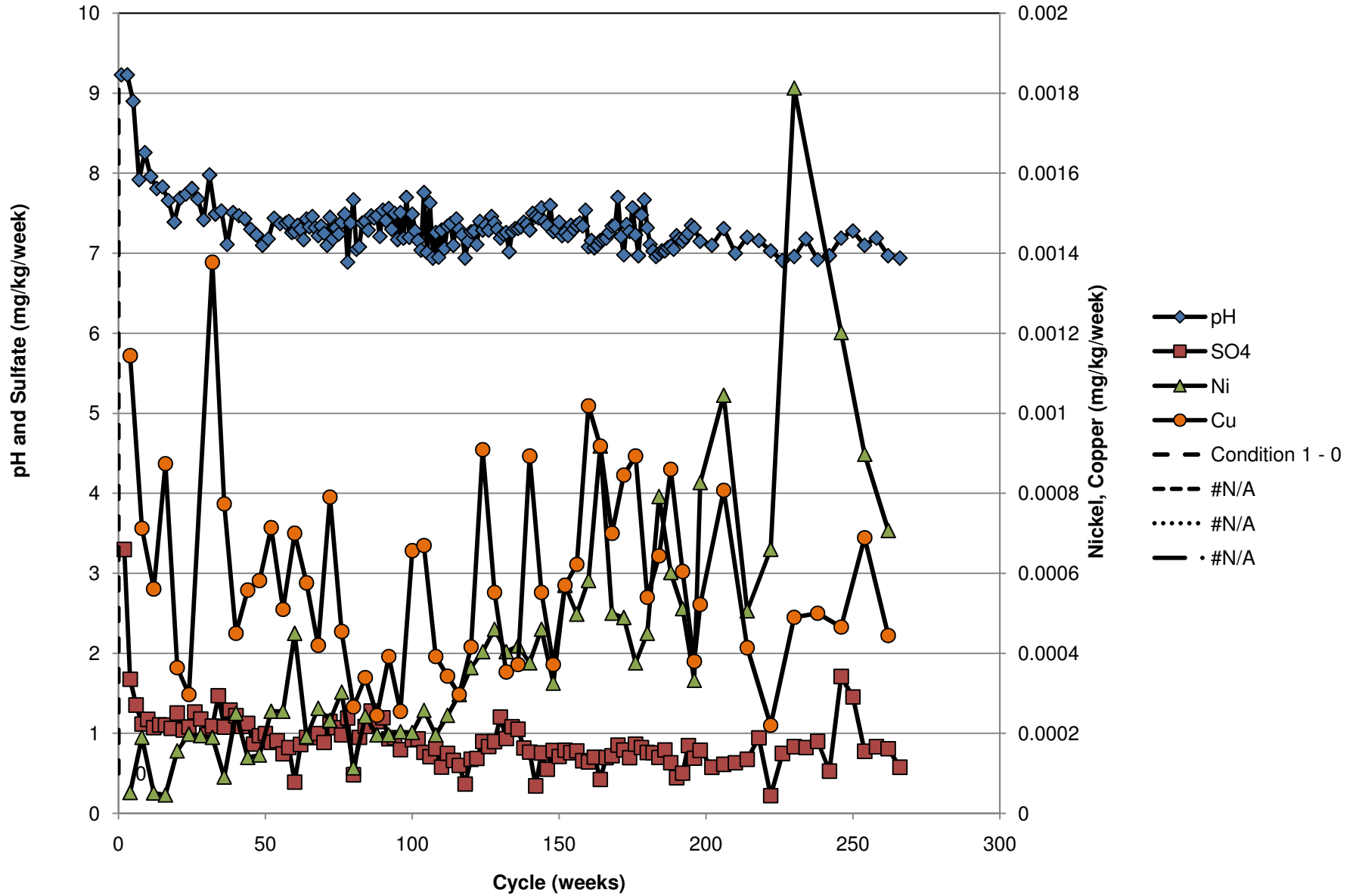



# 00-340C(595-615)

Waste Category:	1
Rock Type:	Troctolitic
Geology:	Duluth Complex
Sulfur:	0.04%

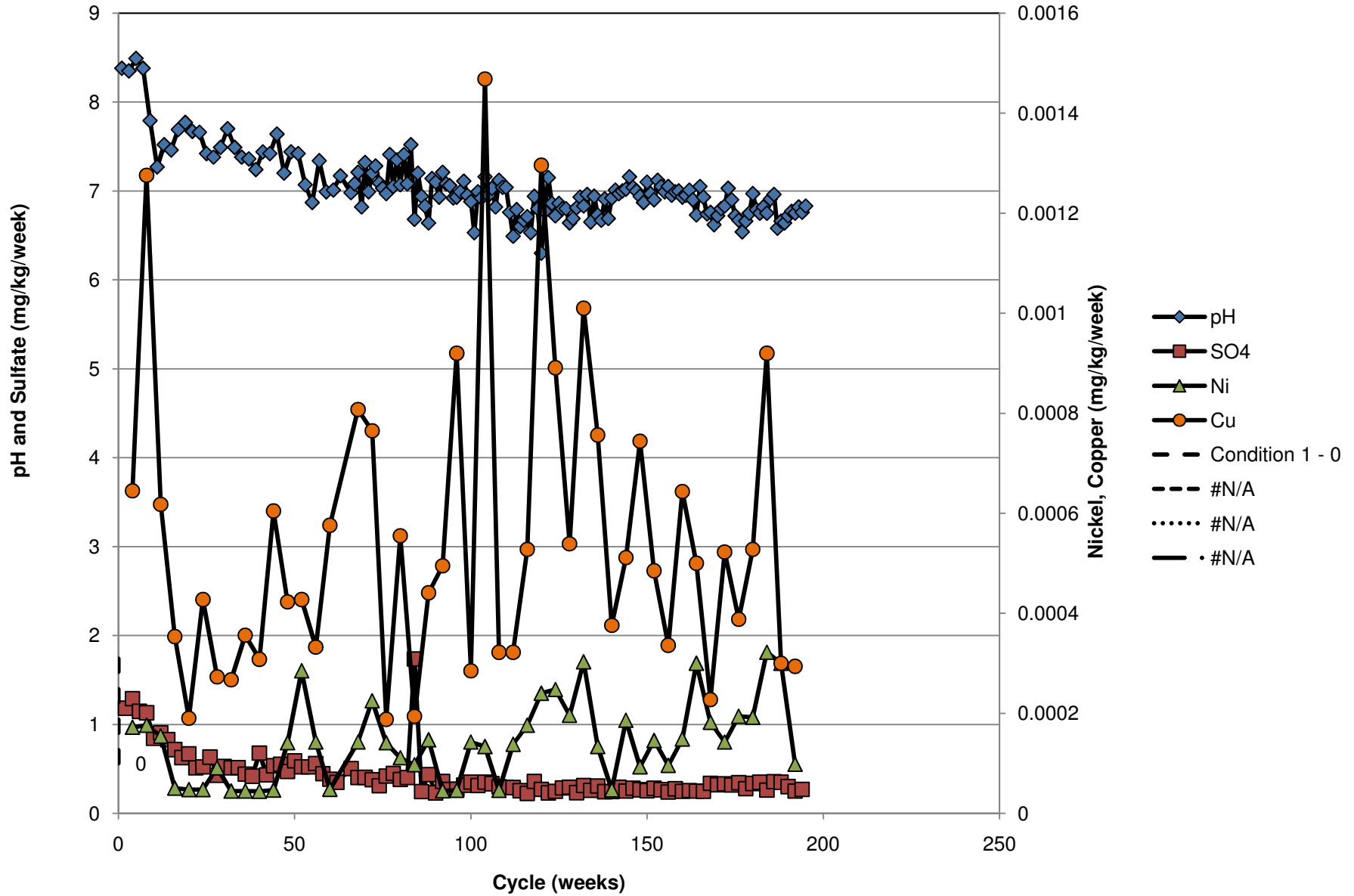

# 00-347C(795-815)

Waste Category:	1
Rock Type:	Troctolitic
Geology:	Duluth Complex
Sulfur:	0.07%

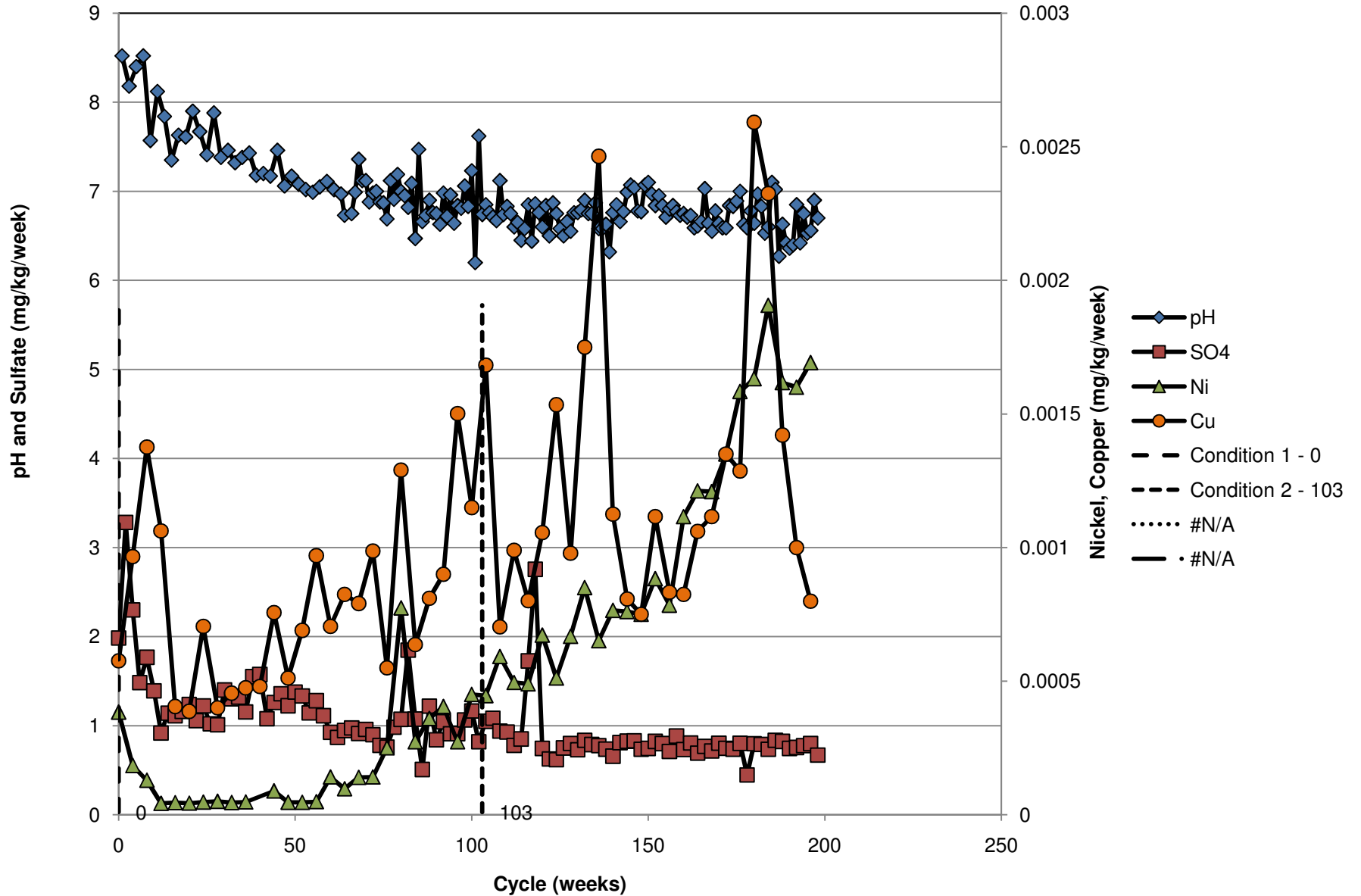

# 99-318C(250-270)

Waste Category:	1
Rock Type:	Troctolitic
Geology:	Duluth Complex
Sulfur:	0.04%

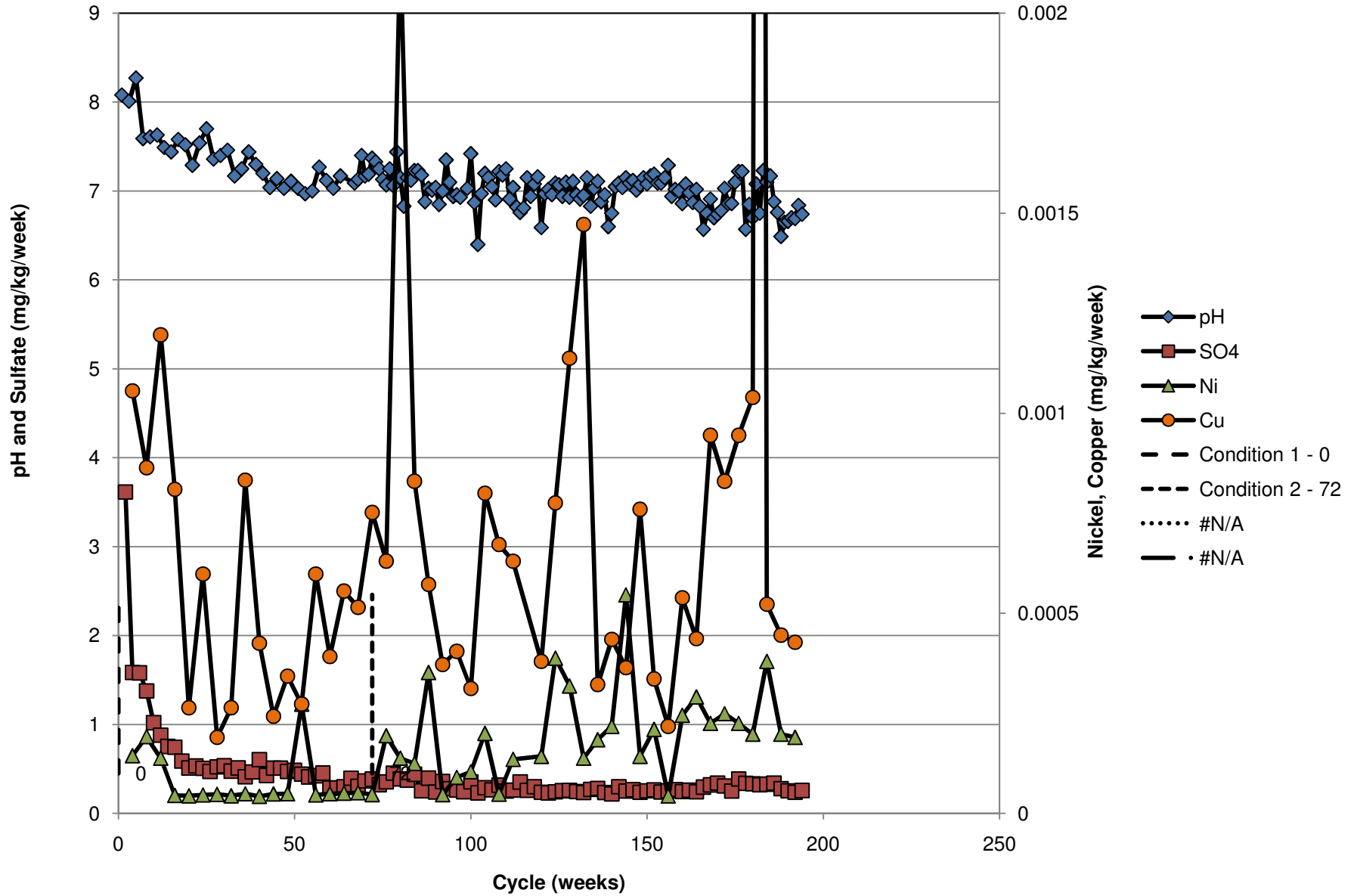

# 00-373C(95-115)

Waste Category:	1
Rock Type:	Troctolitic
Geology:	Duluth Complex
Sulfur:	0.04%

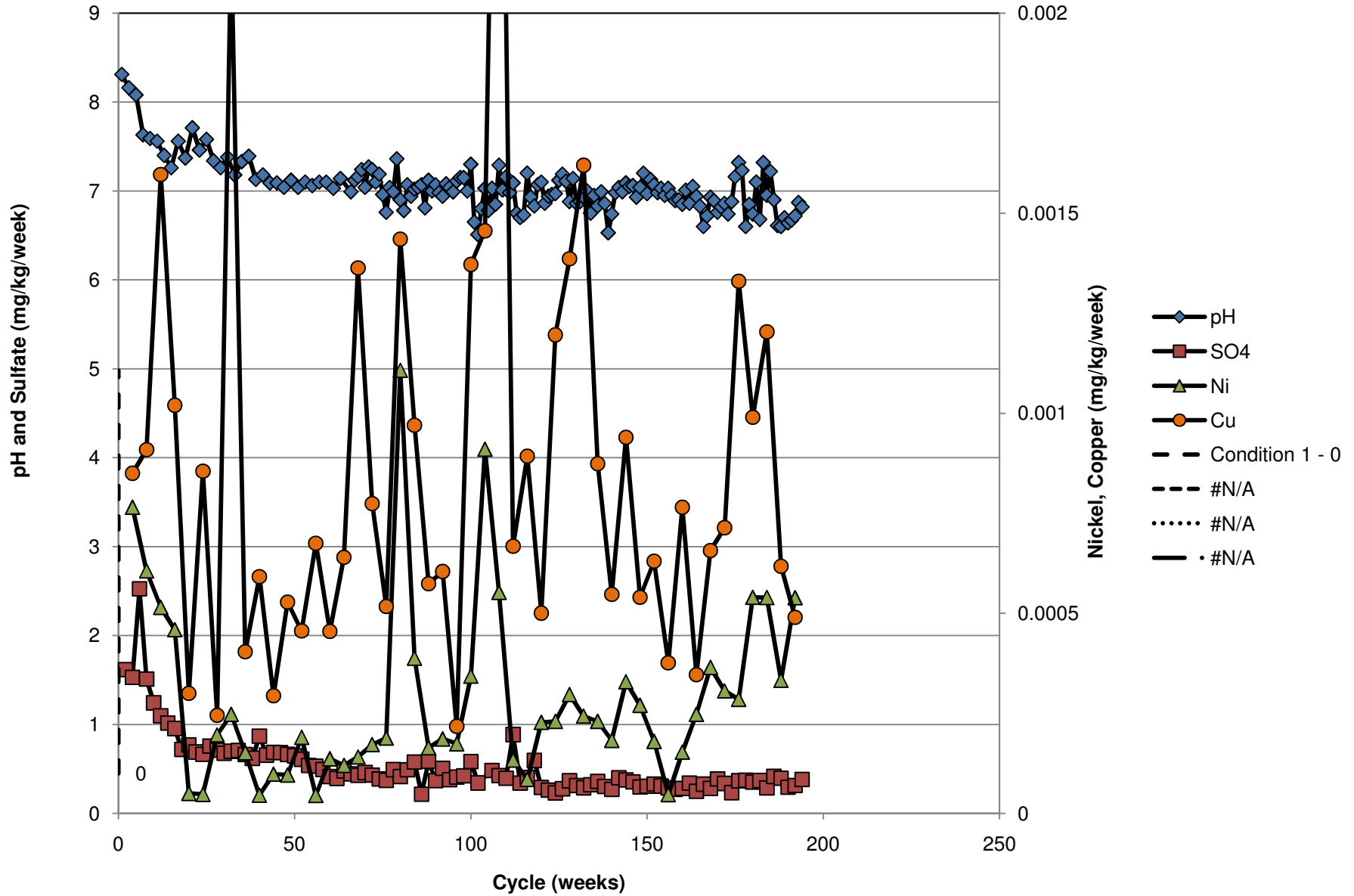

# 00-373C(75-95)

Waste Category:	1
Rock Type:	Troctolitic
Geology:	Duluth Complex
Sulfur:	0.06%

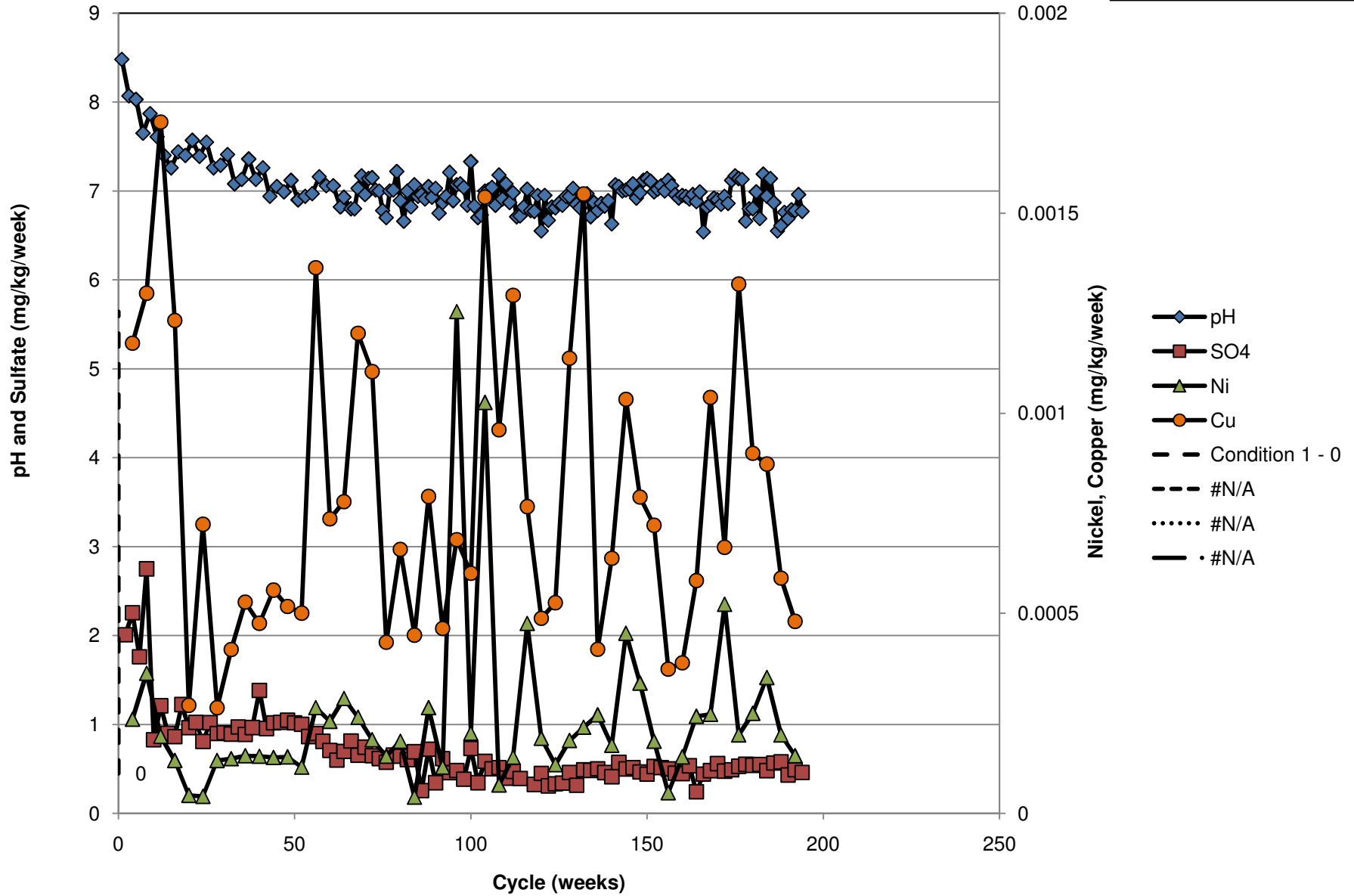

# 00-357C(110-130)

Waste Category:	1
Rock Type:	Troctolitic
Geology:	Duluth Complex
Sulfur:	0.08%

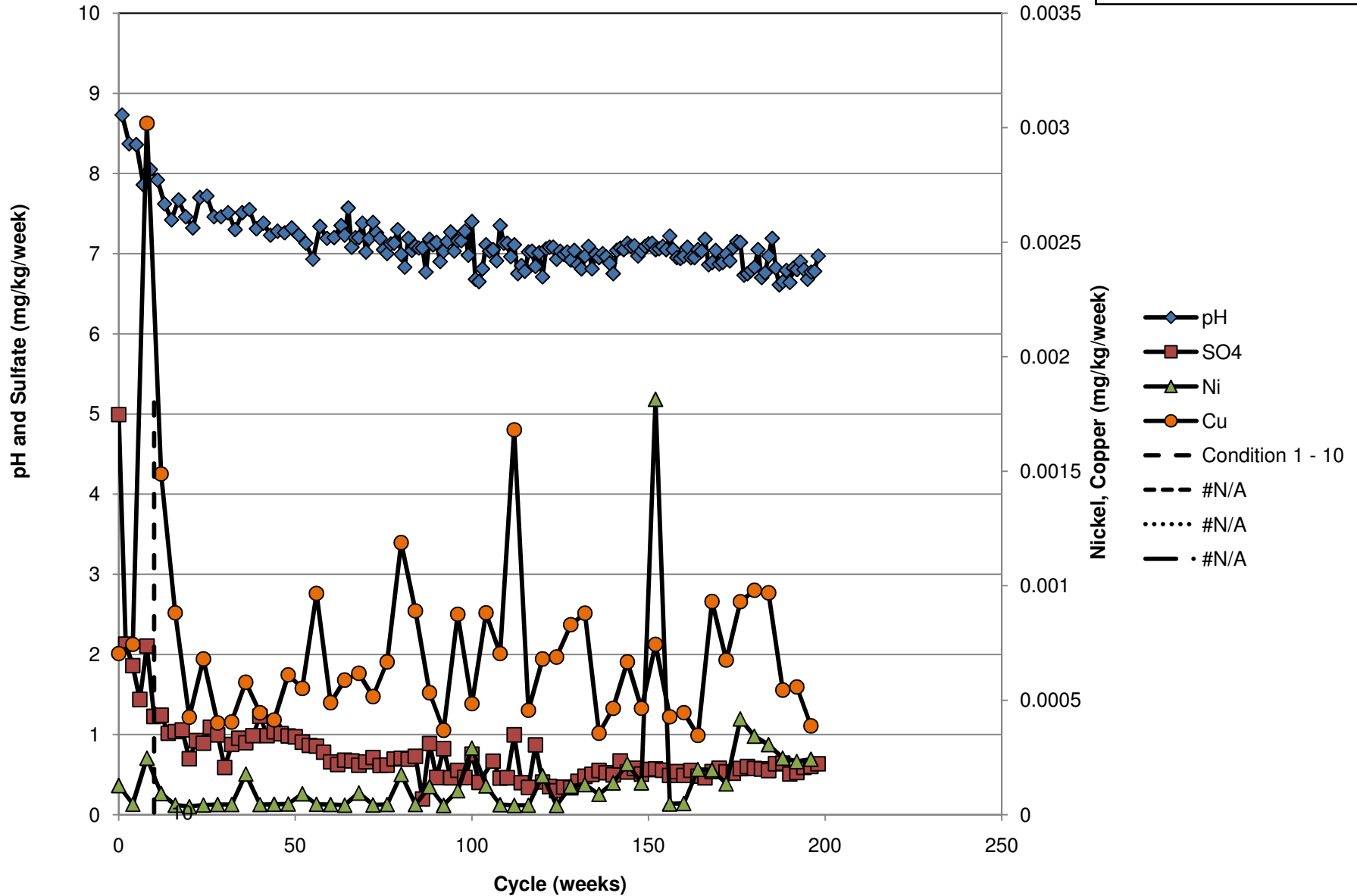

# 00-366C(35-55)

Waste Category:	1
Rock Type:	Troctolitic
Geology:	Duluth Complex
Sulfur:	0.02%

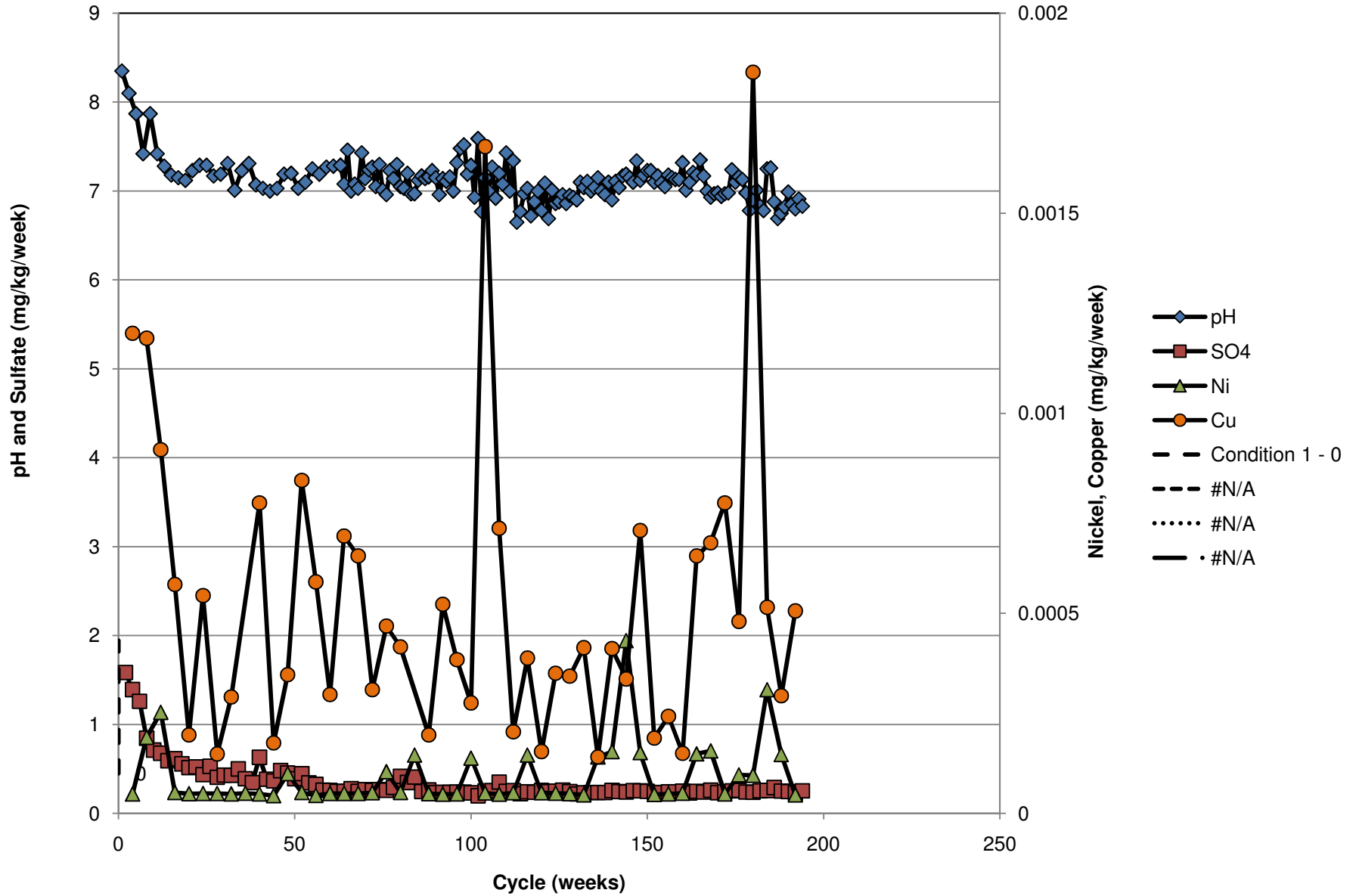

# 00-334C(110-130)

Waste Category:	1
Rock Type:	Troctolitic
Geology:	Duluth Complex
Sulfur:	0.04%

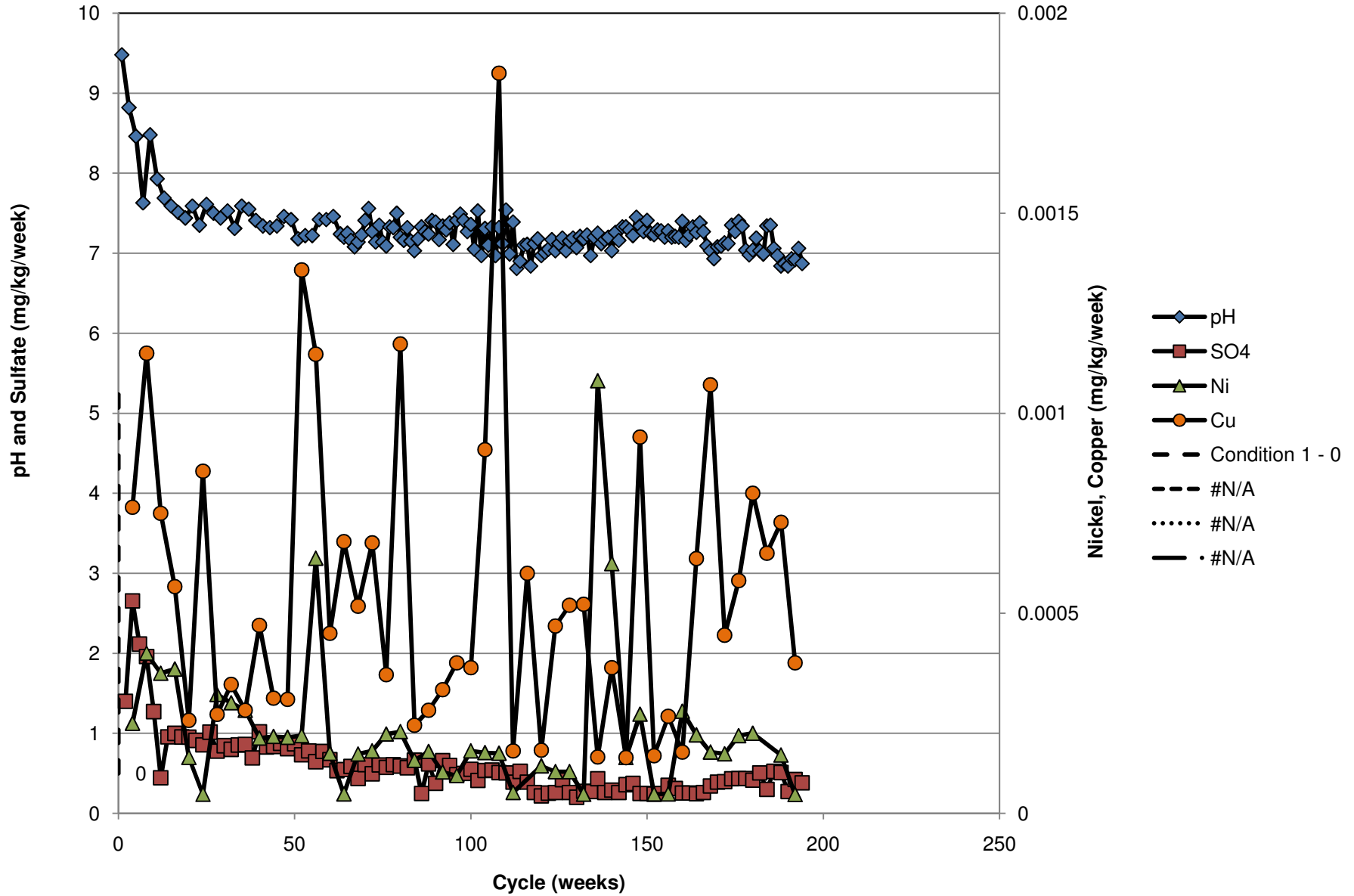



# 00-347C(155-175)

Waste Category:	1
Rock Type:	Troctolitic
Geology:	Duluth Complex
Sulfur:	0.06%

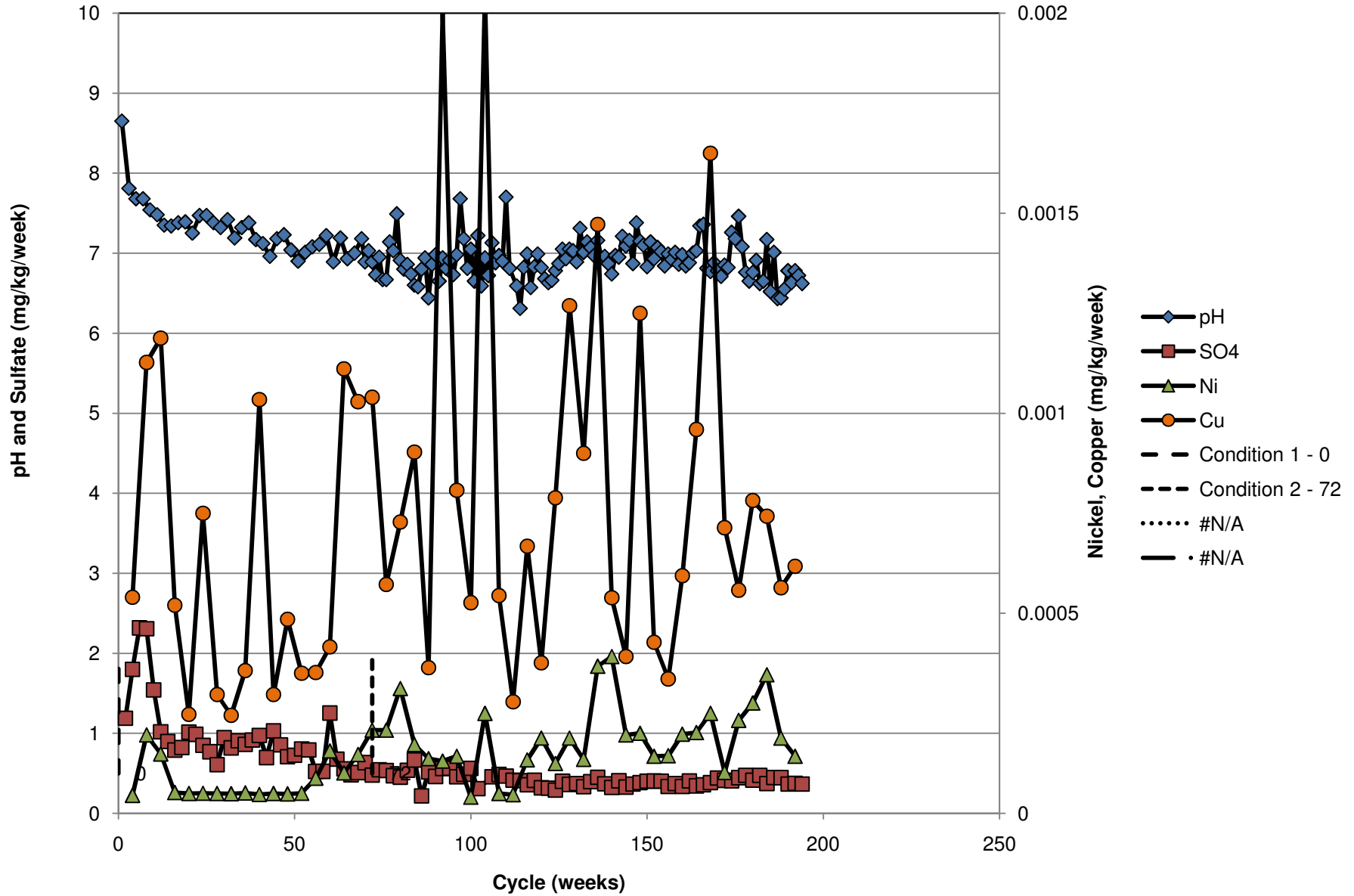

# 00-347C(280-300)

Waste Category:	1
Rock Type:	Troctolitic
Geology:	Duluth Complex
Sulfur:	0.06%

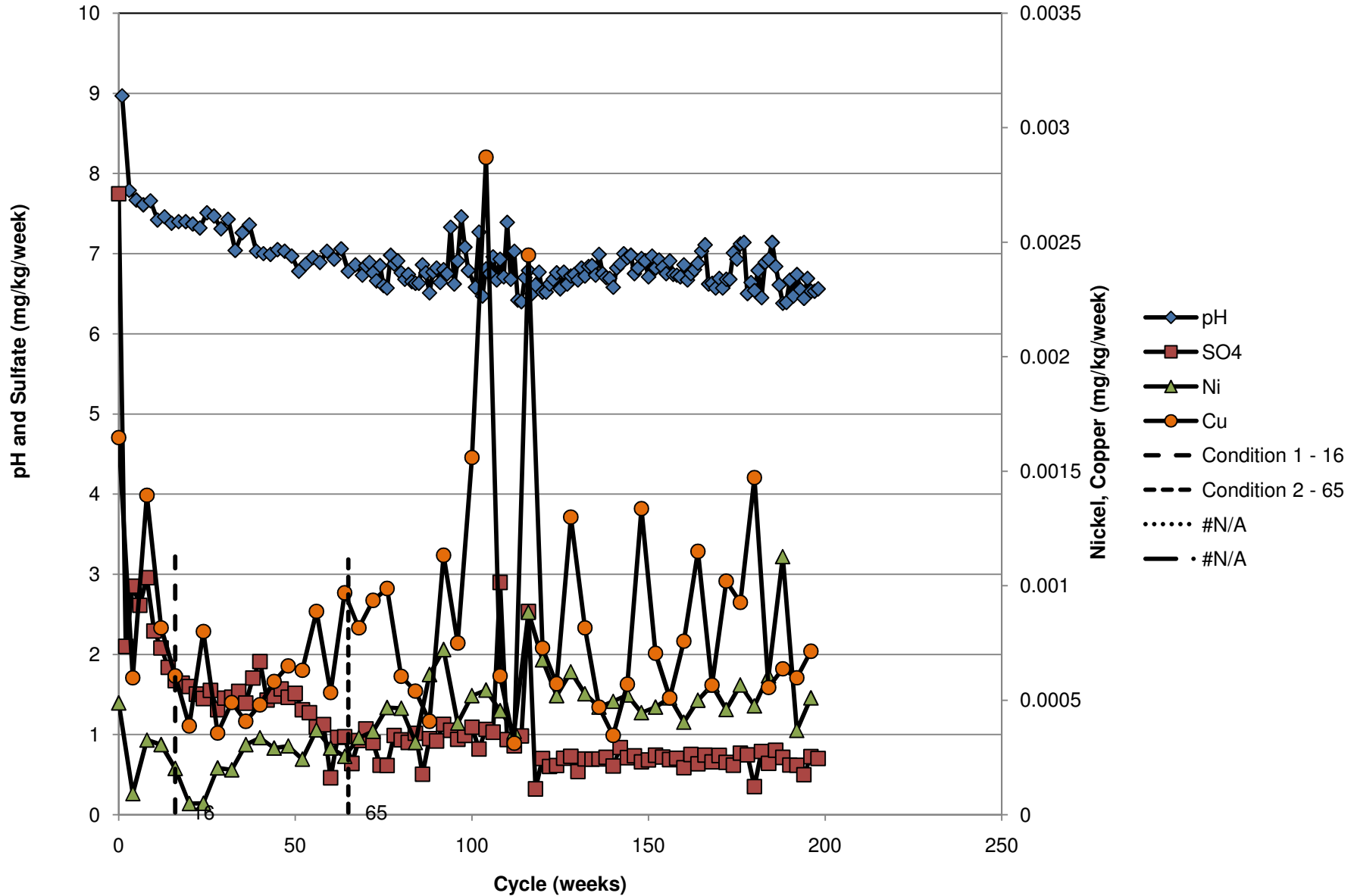

# 00-367C(50-65)

Waste Category:	1
Rock Type:	Troctolitic
Geology:	Duluth Complex
Sulfur:	0.03%

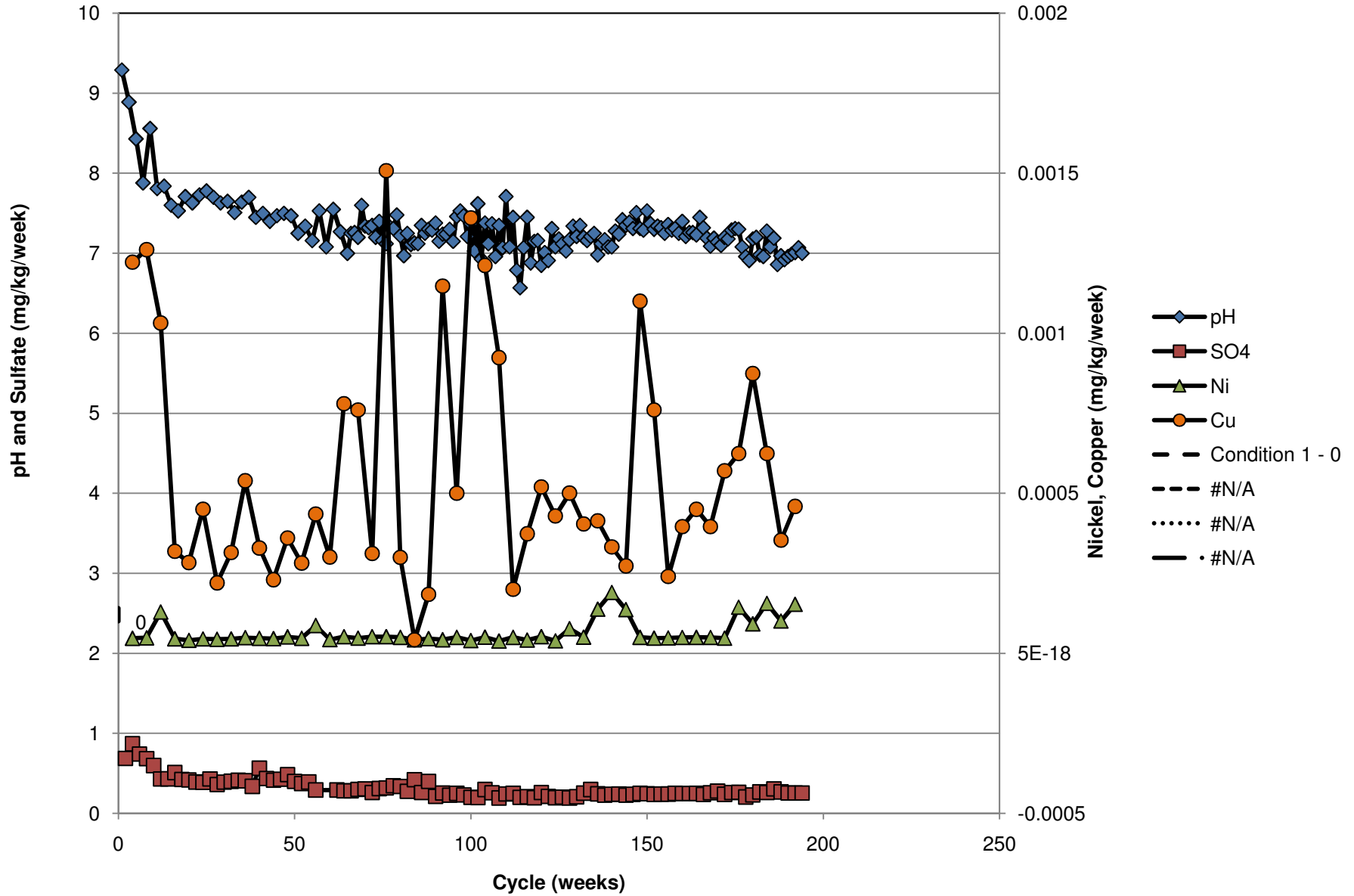

# 00-367C(260-280)

Waste Category:	1
Rock Type:	Troctolitic
Geology:	Duluth Complex
Sulfur:	0.04%

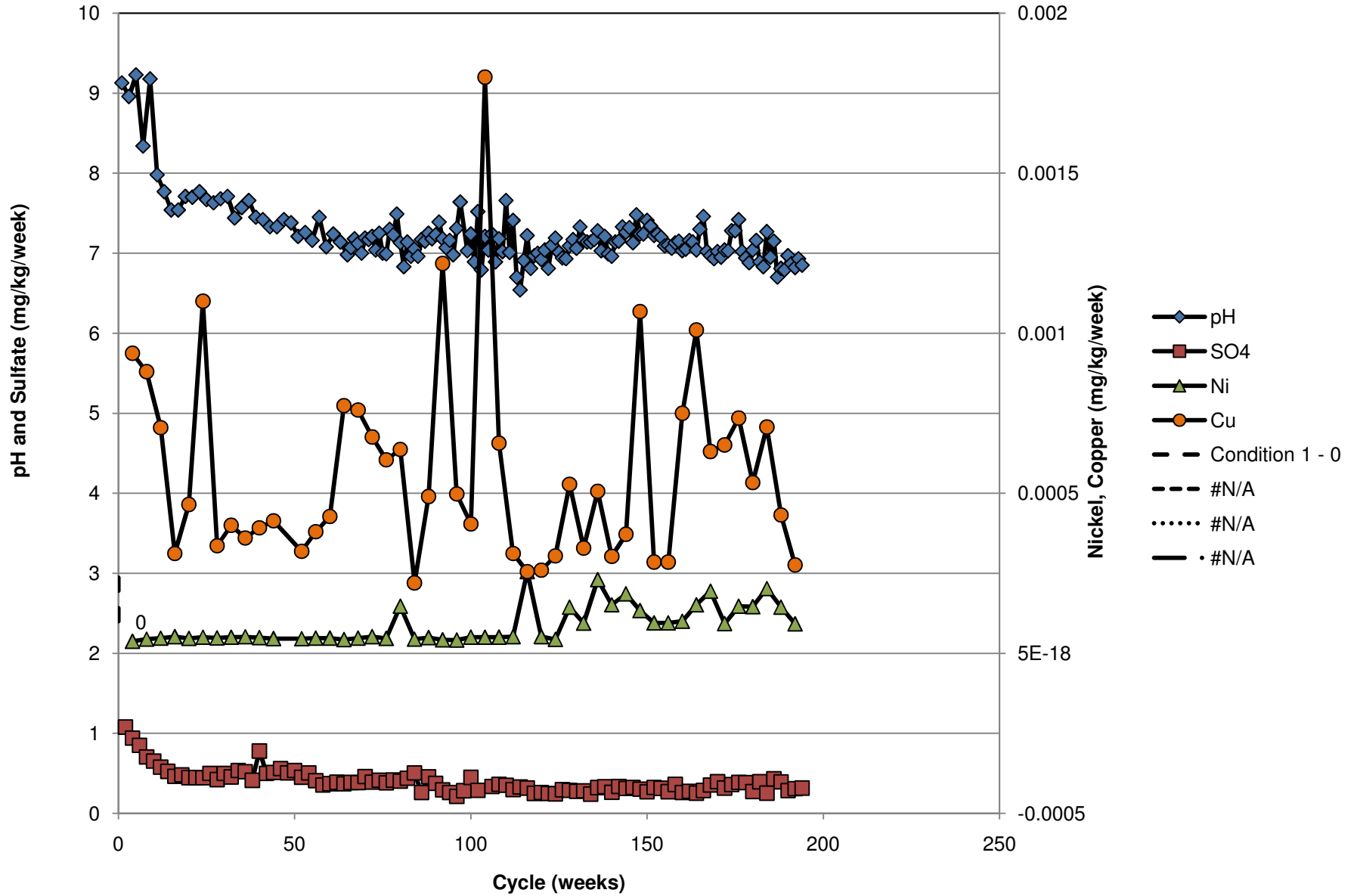

# 00-370C(20-30)

Waste Category:	1
Rock Type:	Troctolitic
Geology:	Duluth Complex
Sulfur:	0.08%

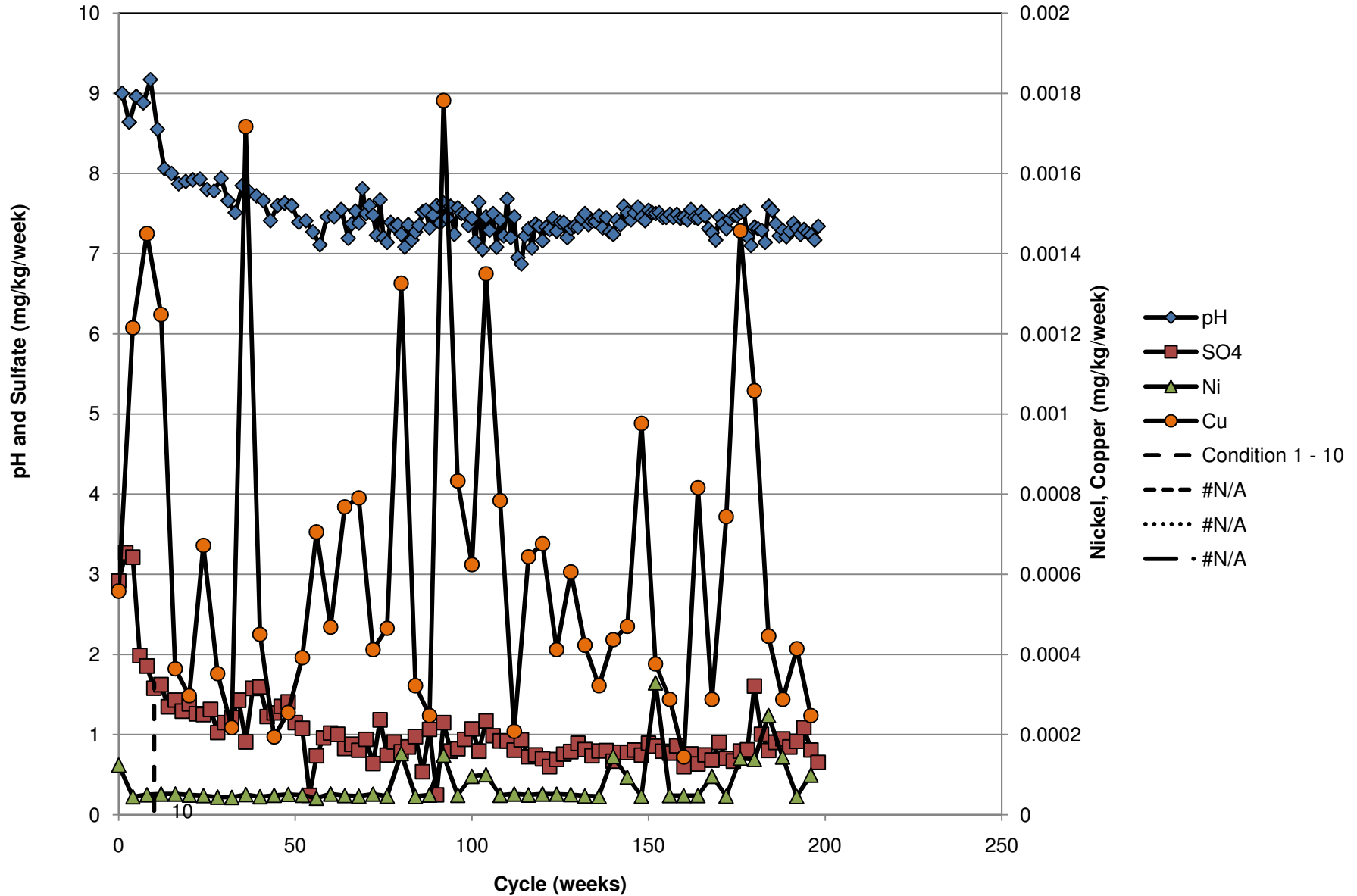

Waste Category:	1
Rock Type:	Troctolitic
Geology:	Duluth Complex
Sulfur:	0.04%

## 26056(110-125)

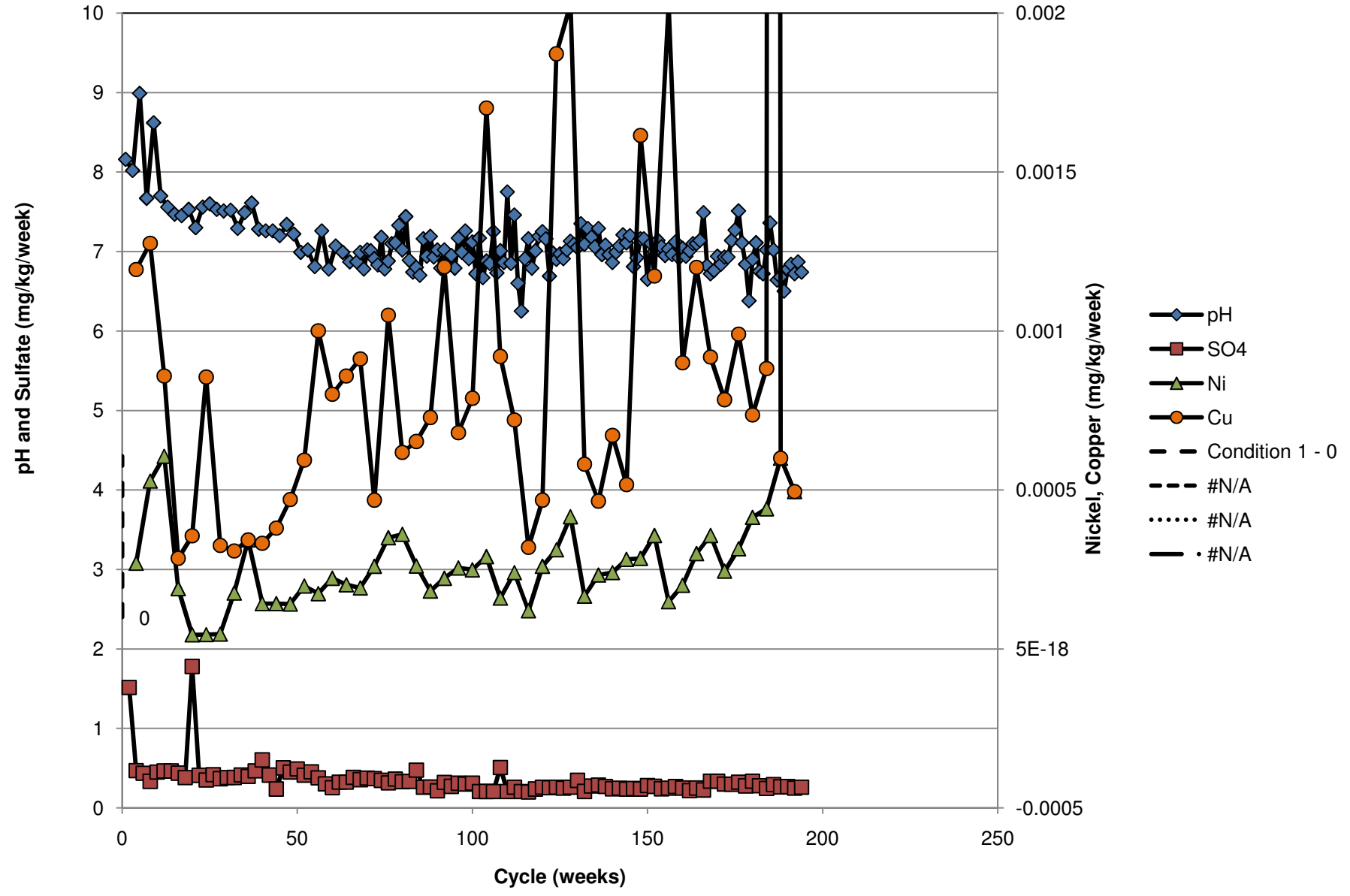

# 26029(815-825)

Waste Category:	1
Rock Type:	Troctolitic
Geology:	Duluth Complex
Sulfur:	0.02%

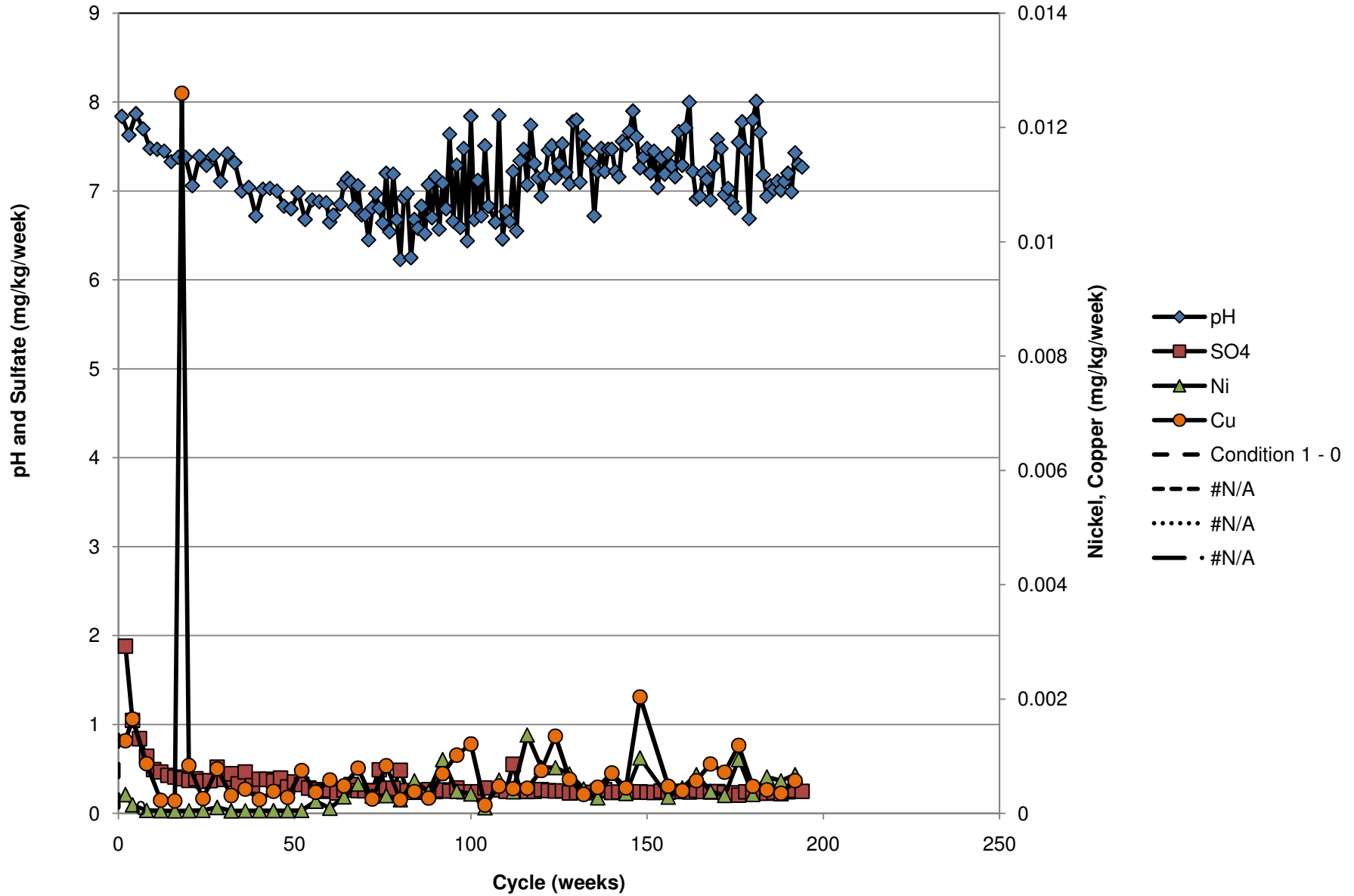

# 00-326C(250-265)

Waste Category:	1
Rock Type:	Troctolitic
Geology:	Duluth Complex
Sulfur:	0.08%

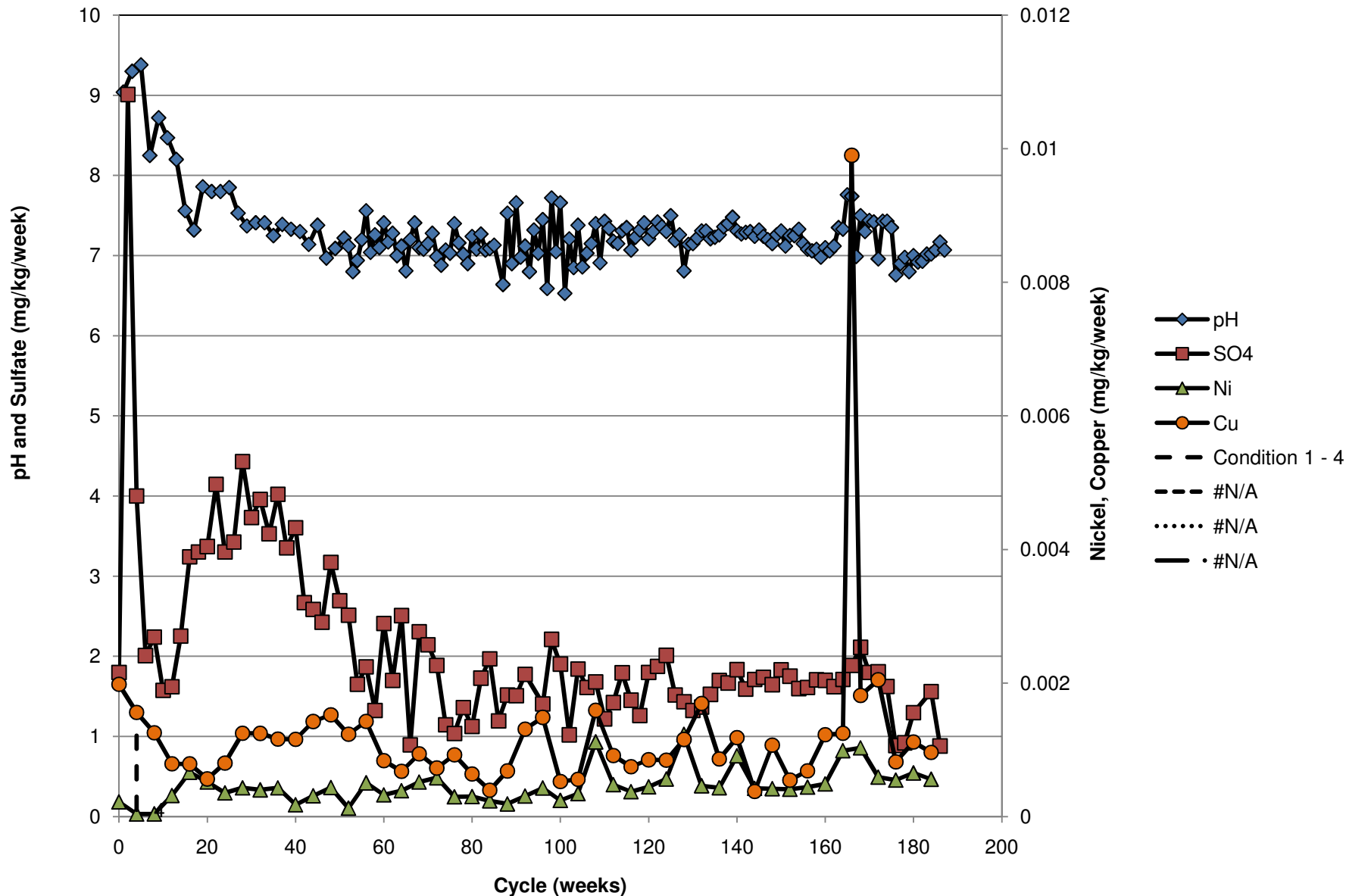



# 00-326C(225-235)

Waste Category:	1
Rock Type:	Ultramafic
Geology:	Duluth Complex
Sulfur:	0.12%

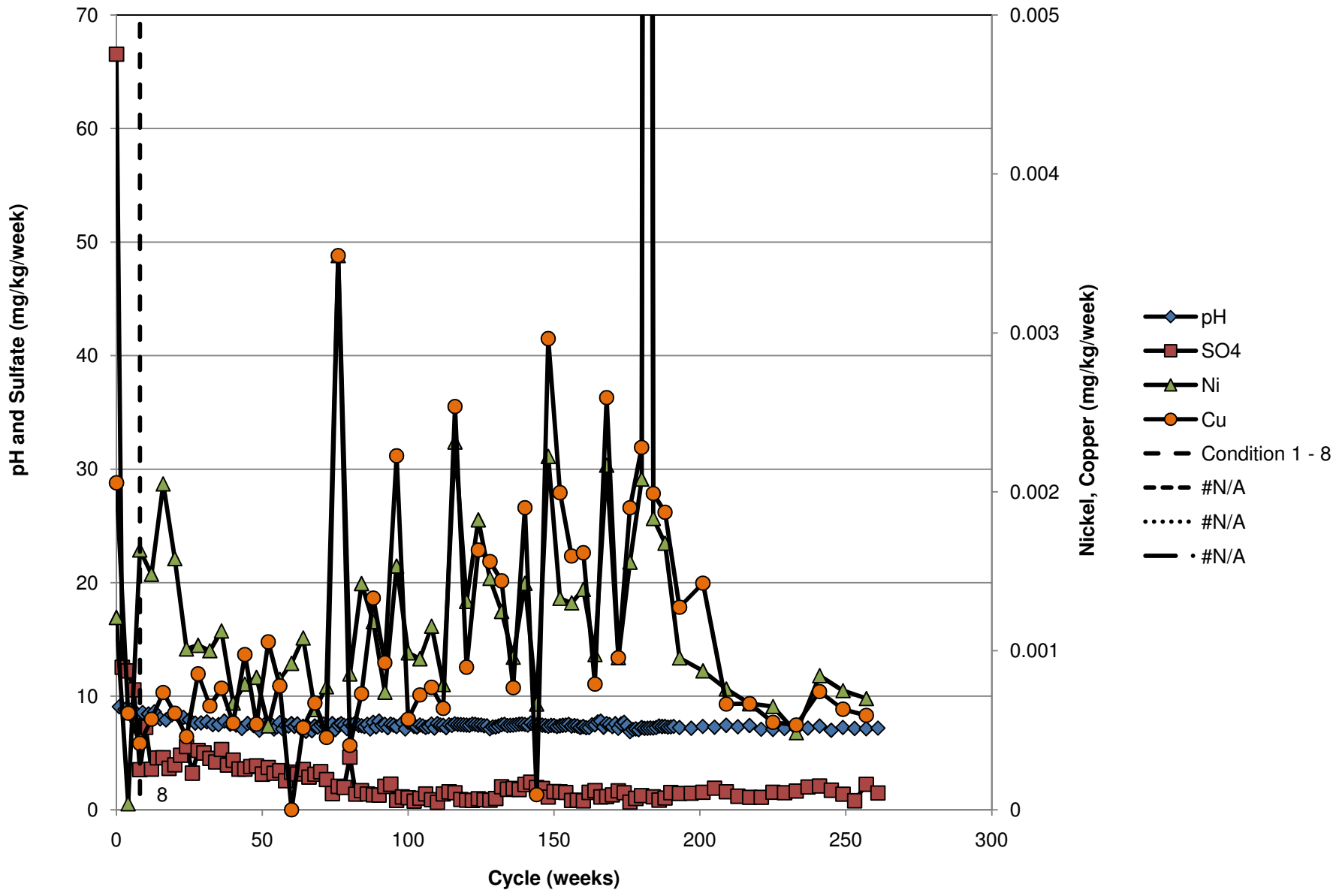

# 00-357C(335-340)

Waste Category:	1
Rock Type:	Ultramafic
Geology:	Duluth Complex
Sulfur:	0.08%

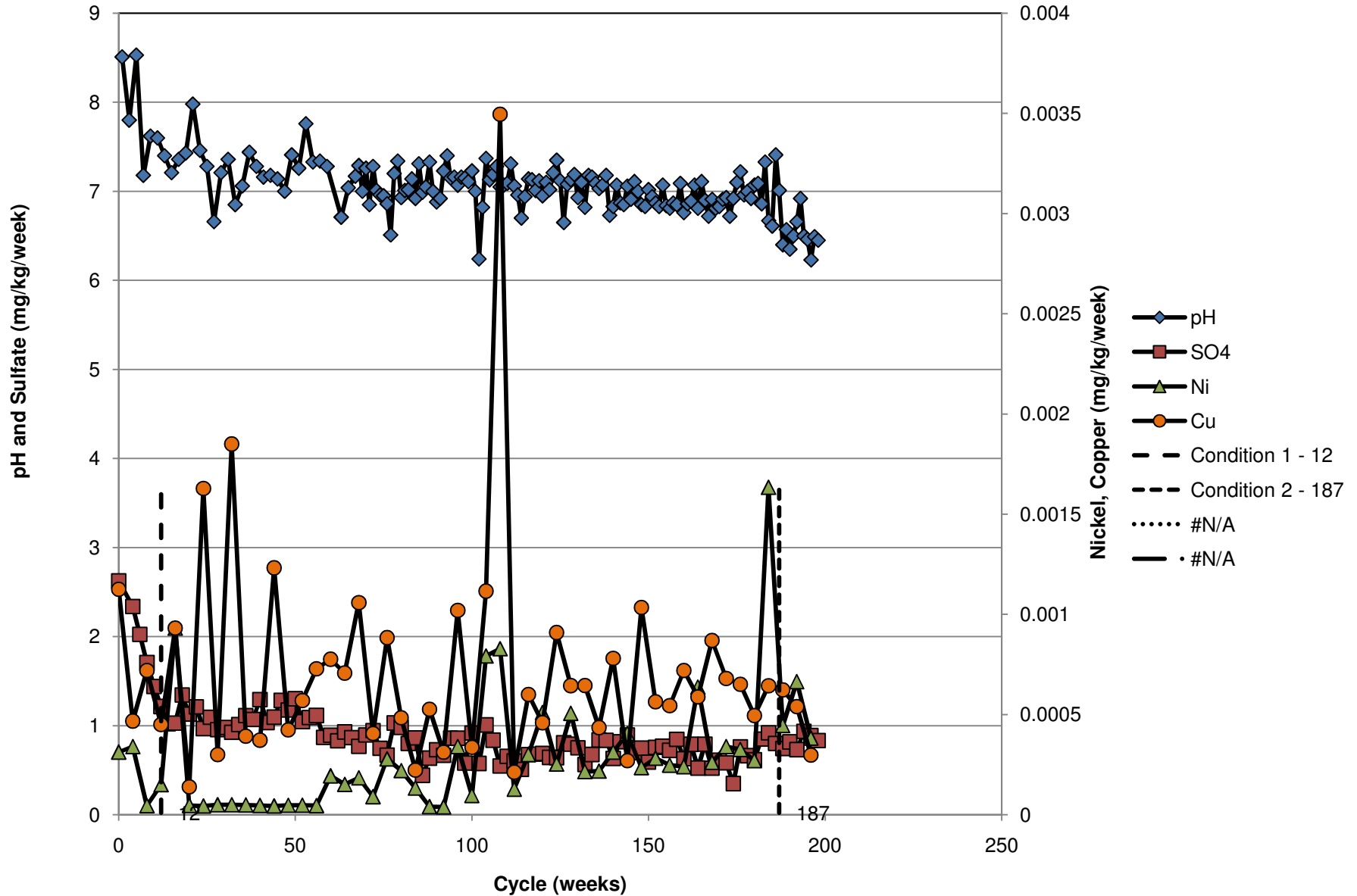

# 00-368C(460-465)

Waste Category:	1
Rock Type:	Ultramafic
Geology:	Duluth Complex
Sulfur:	0.06%

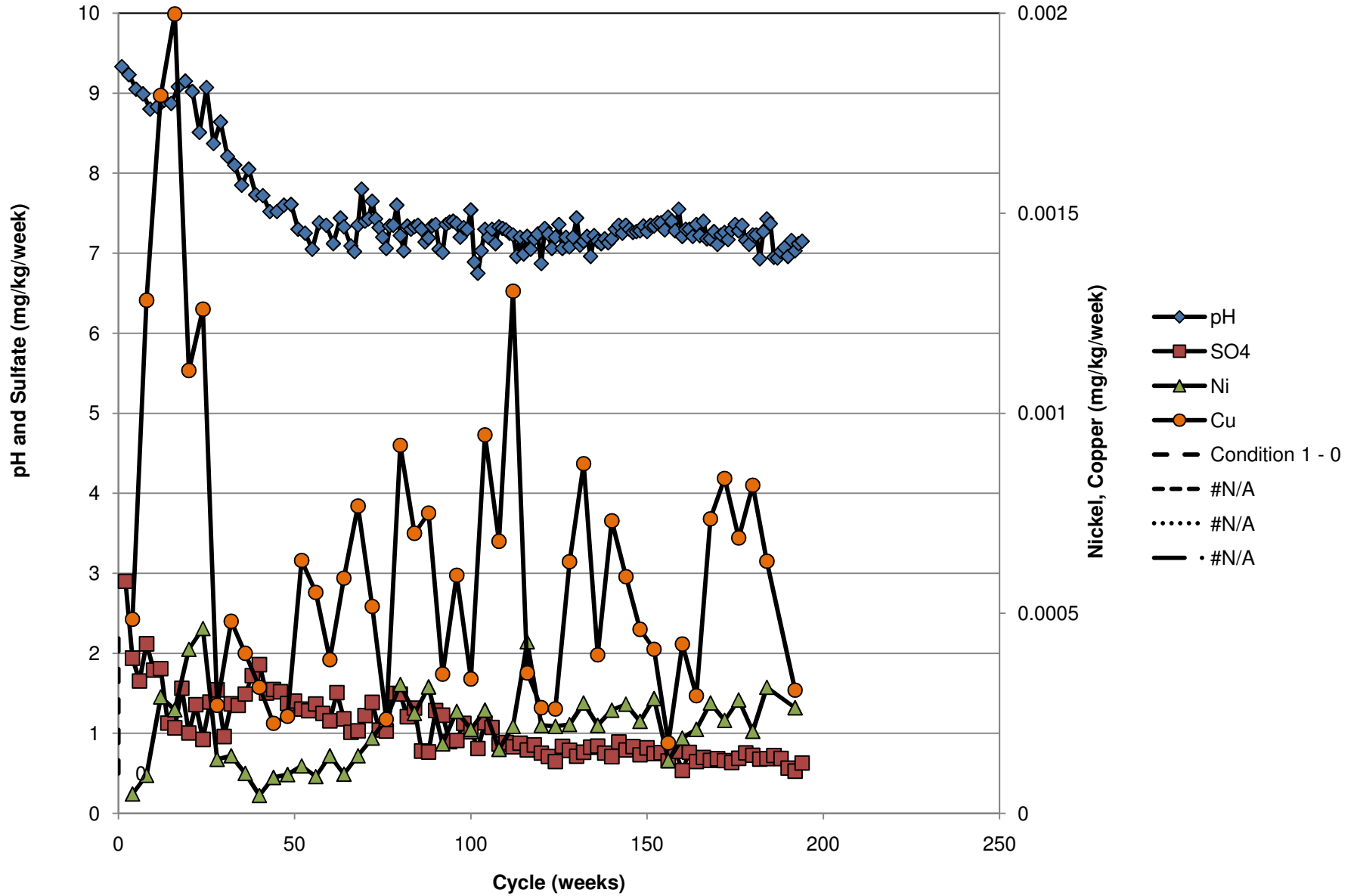

# 26055(940-945)

Waste Category:	1
Rock Type:	Ultramafic
Geology:	Duluth Complex
Sulfur:	0.06%

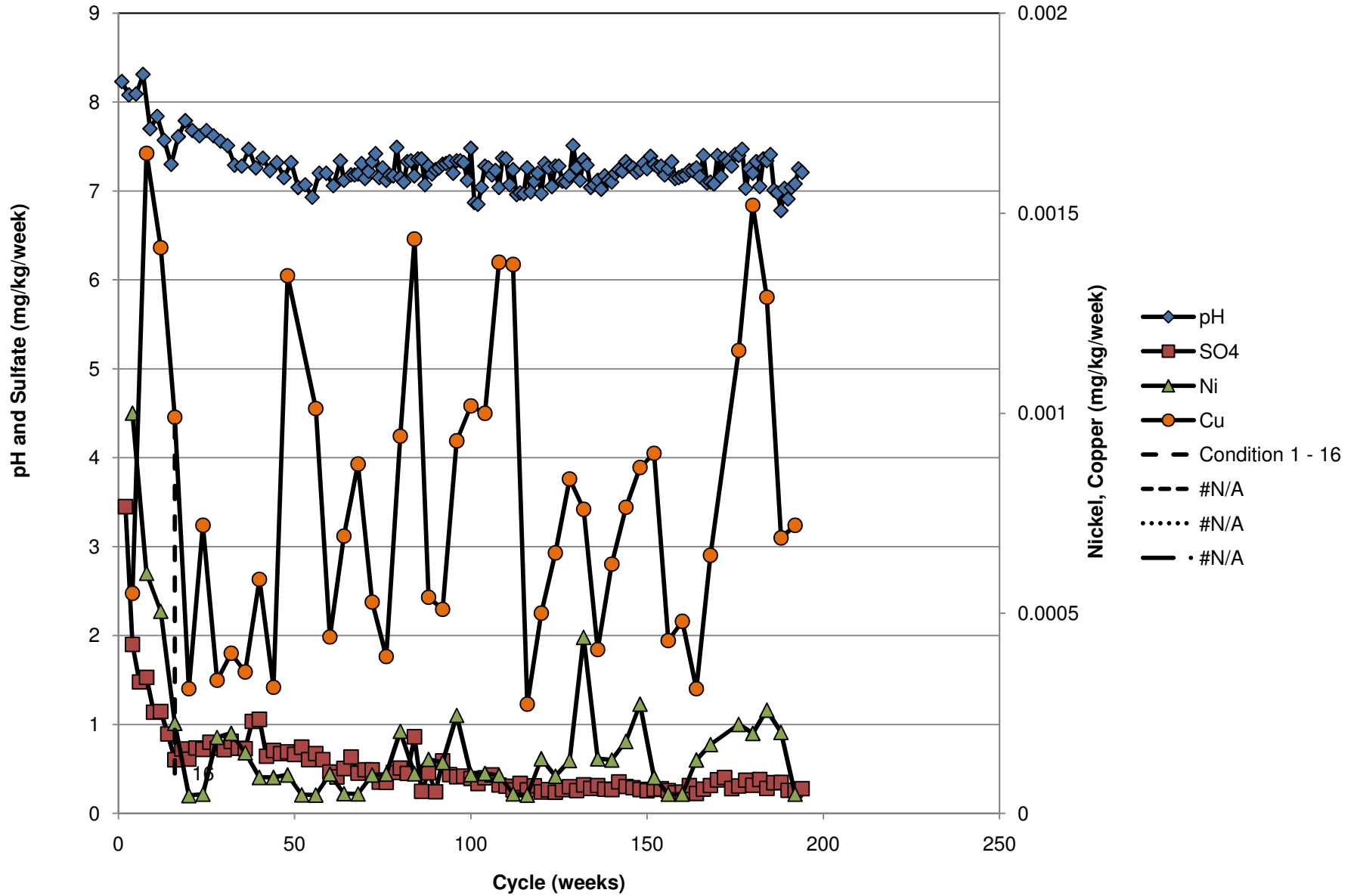

# 26098+00-337C

Waste Category:	1
Rock Type:	Ultramafic
Geology:	Duluth Complex
Sulfur:	0.10%

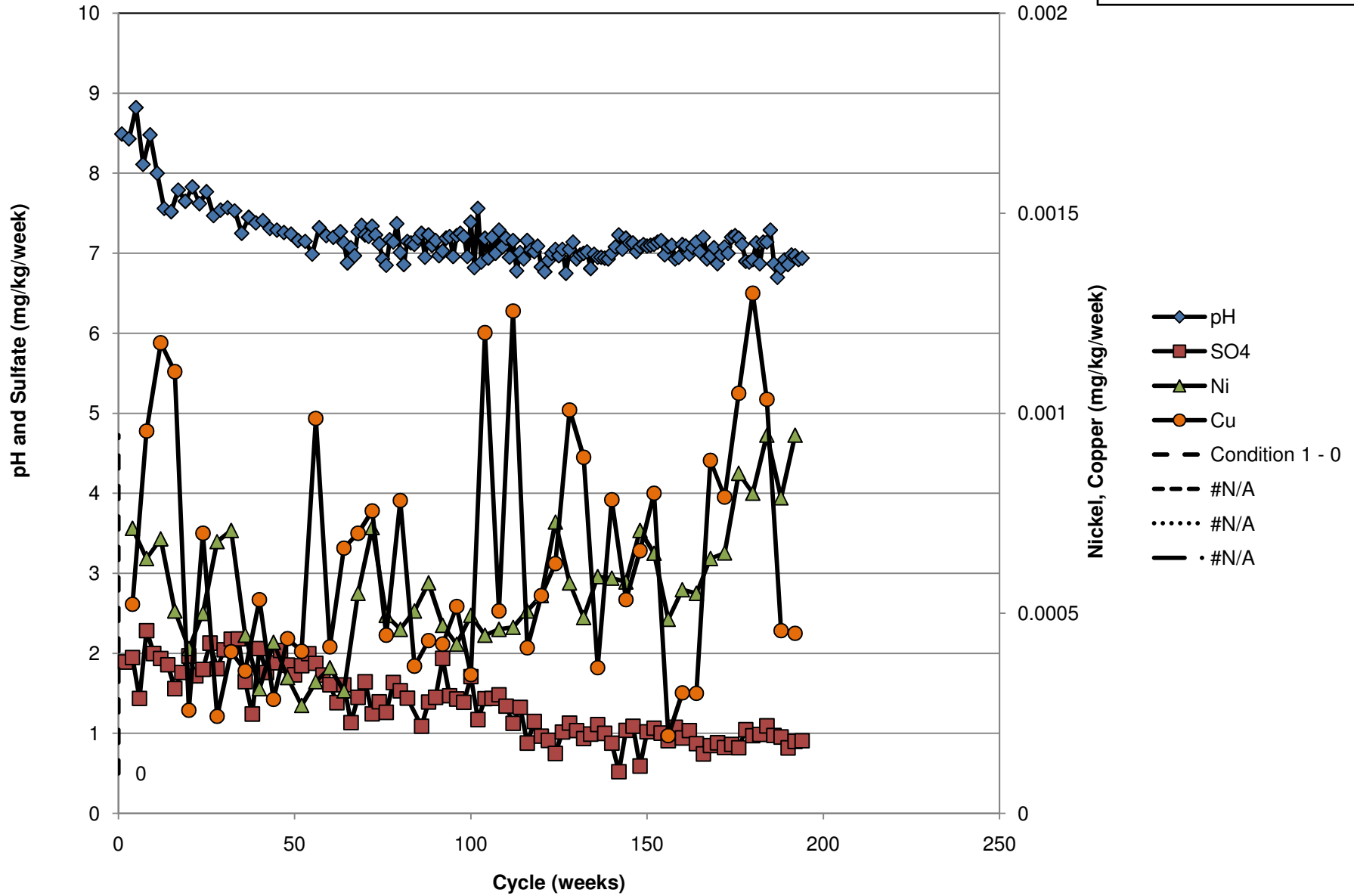

# 00-361C(240-245)

Waste Category:	1
Rock Type:	Ultramafic
Geology:	Duluth Complex
Sulfur:	0.06%

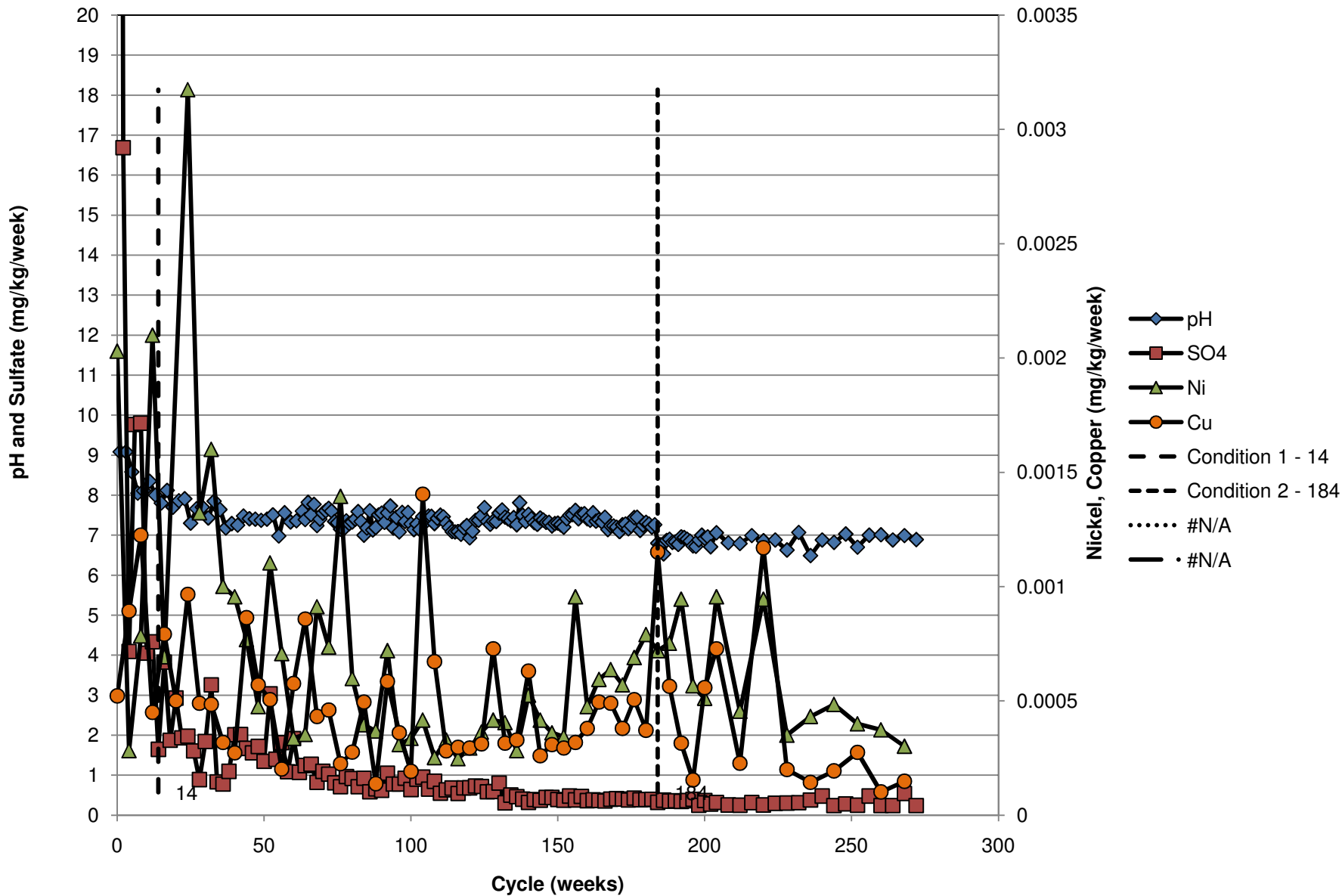

# 26039(310-315)

Waste Category:	1
Rock Type:	Ultramafic
Geology:	Duluth Complex
Sulfur:	0.06%

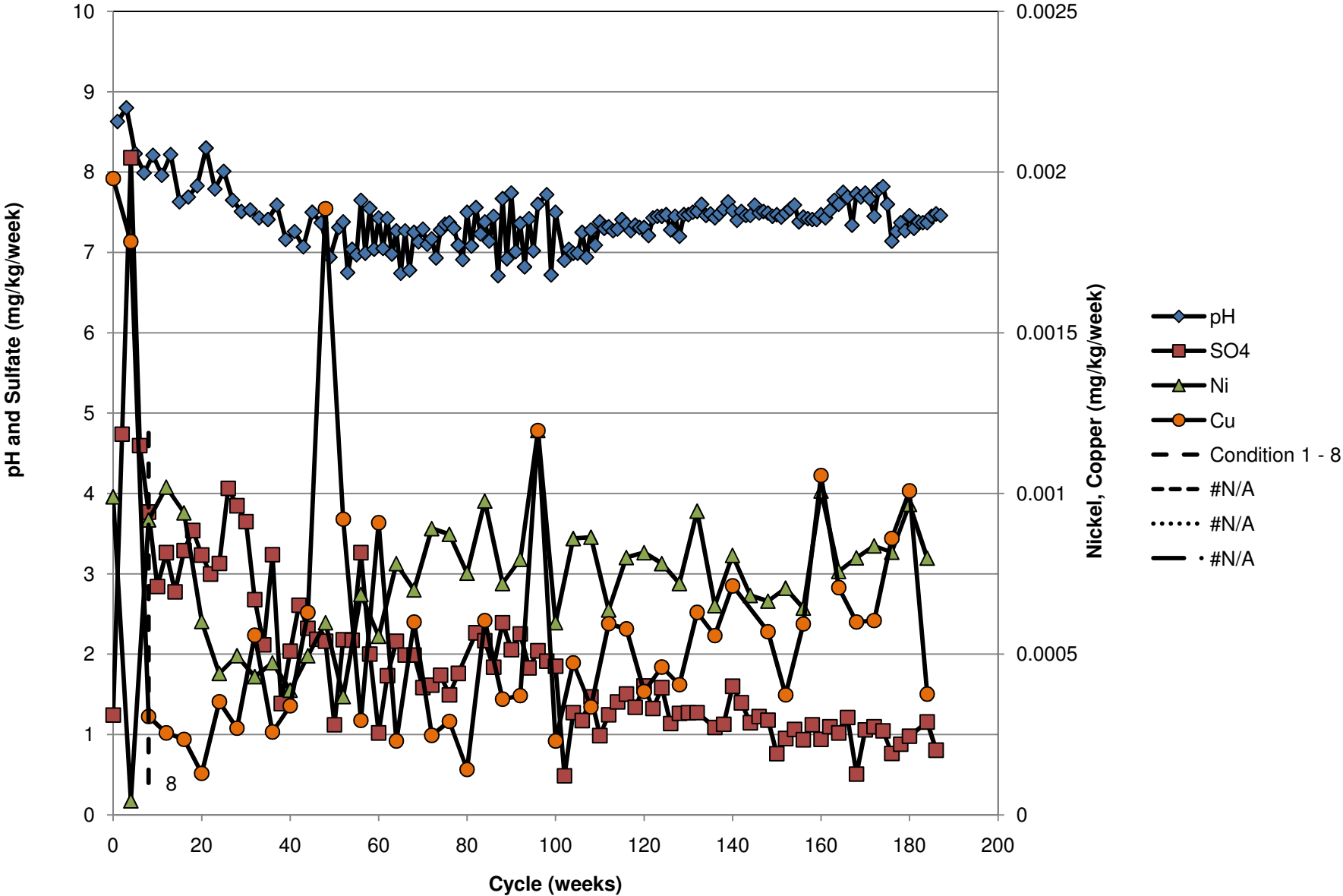

**b. Category 2/3**



# 00-361C(310-320)

Waste Category:	2/3
Rock Type:	Anorthositic
Geology:	Duluth Complex
Sulfur:	0.18%

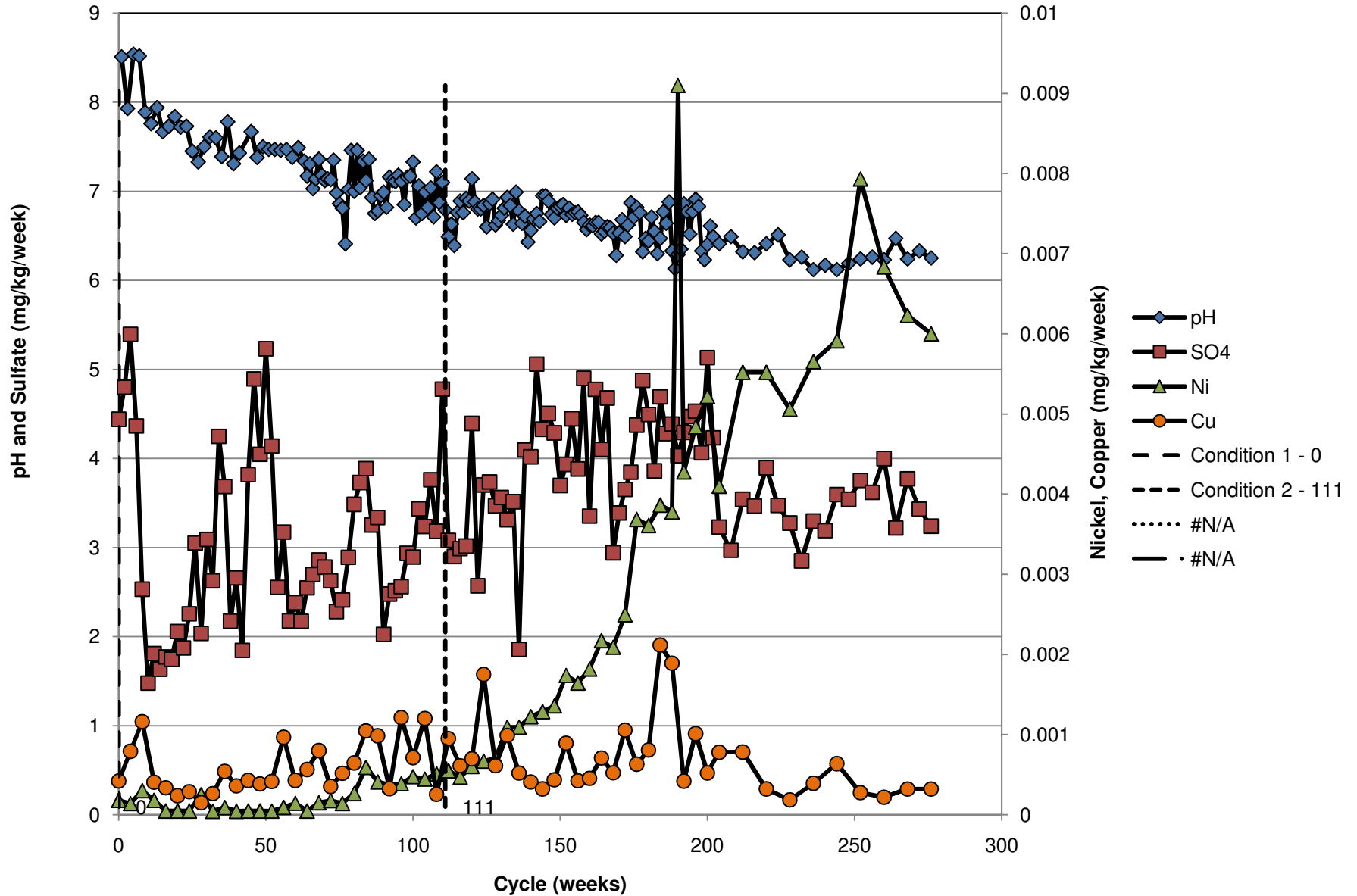

# 99-320C(400-405)

Waste Category:	2/3
Rock Type:	Anorthositic
Geology:	Duluth Complex
Sulfur:	0.18%

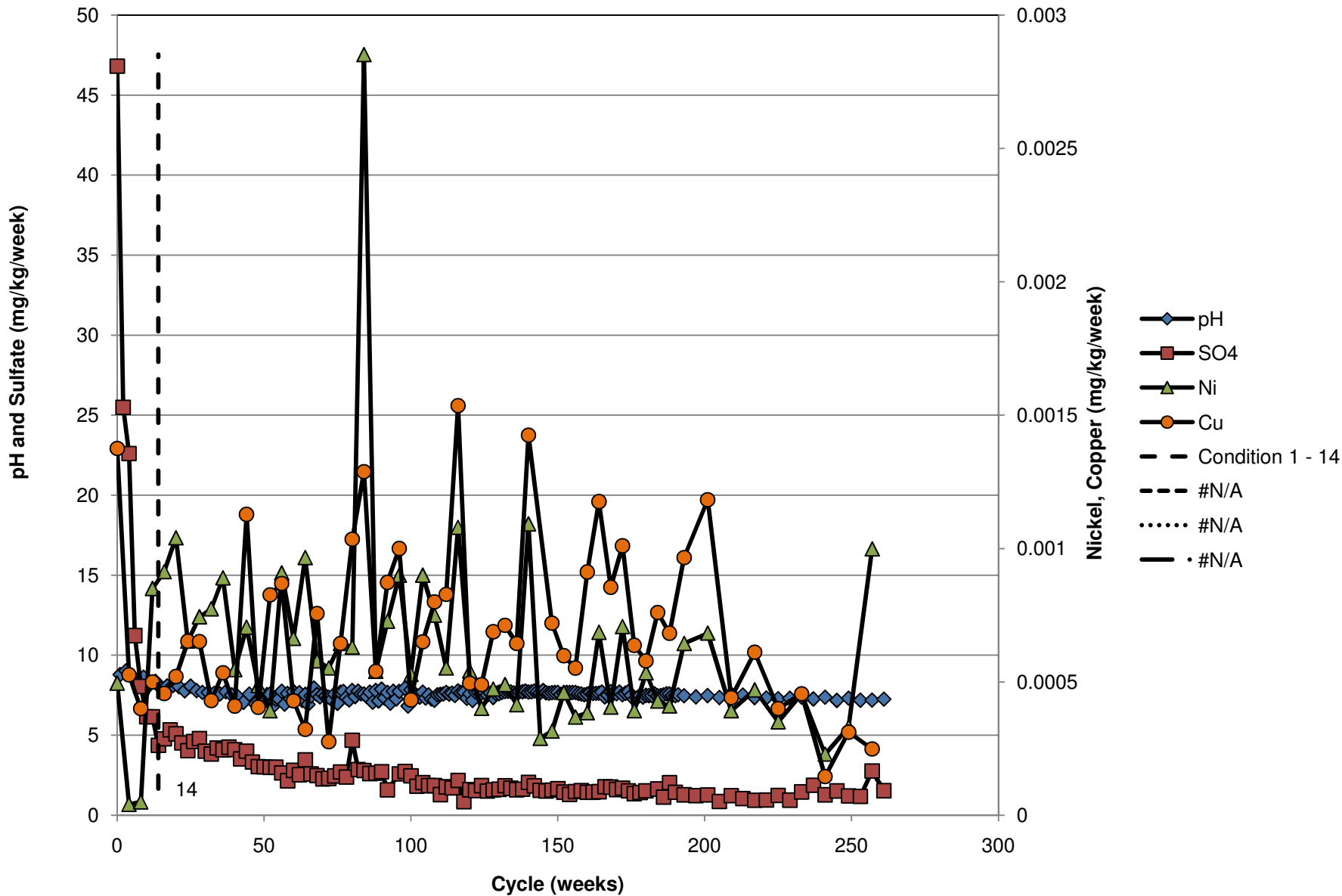

# 26030(1047-1052)

Waste Category:	2/3
Rock Type:	Sedimentary Hornfels
Geology:	Duluth Complex
Sulfur:	0.24%

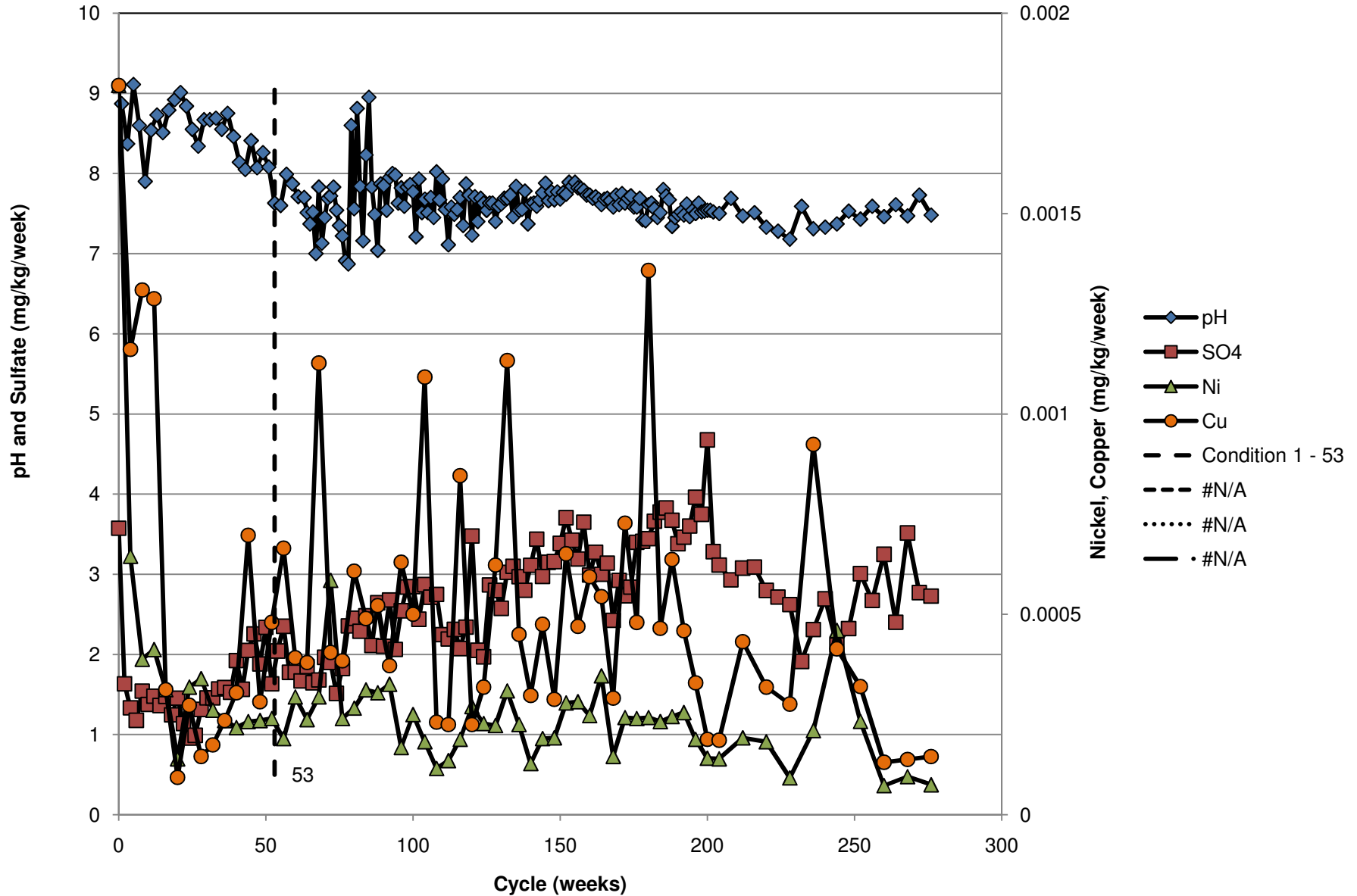

# 26061(1218-1233)

Waste Category:	2/3
Rock Type:	Sedimentary Hornfels
Geology:	Duluth Complex
Sulfur:	0.44%

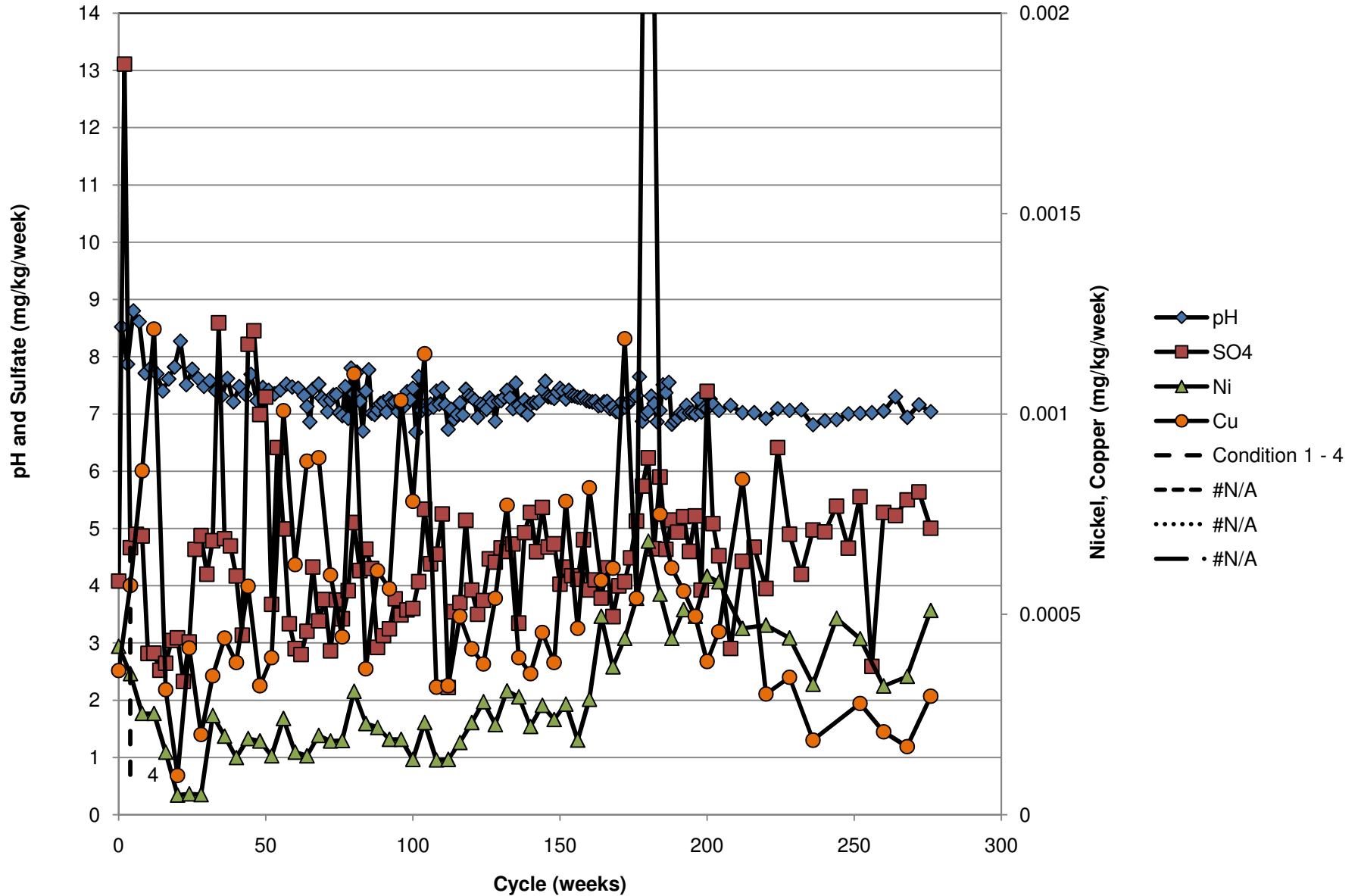

# 00-340C(990-995)

Waste Category:	2/3
Rock Type:	Sedimentary Hornfels
Geology:	Duluth Complex
Sulfur:	0.55%

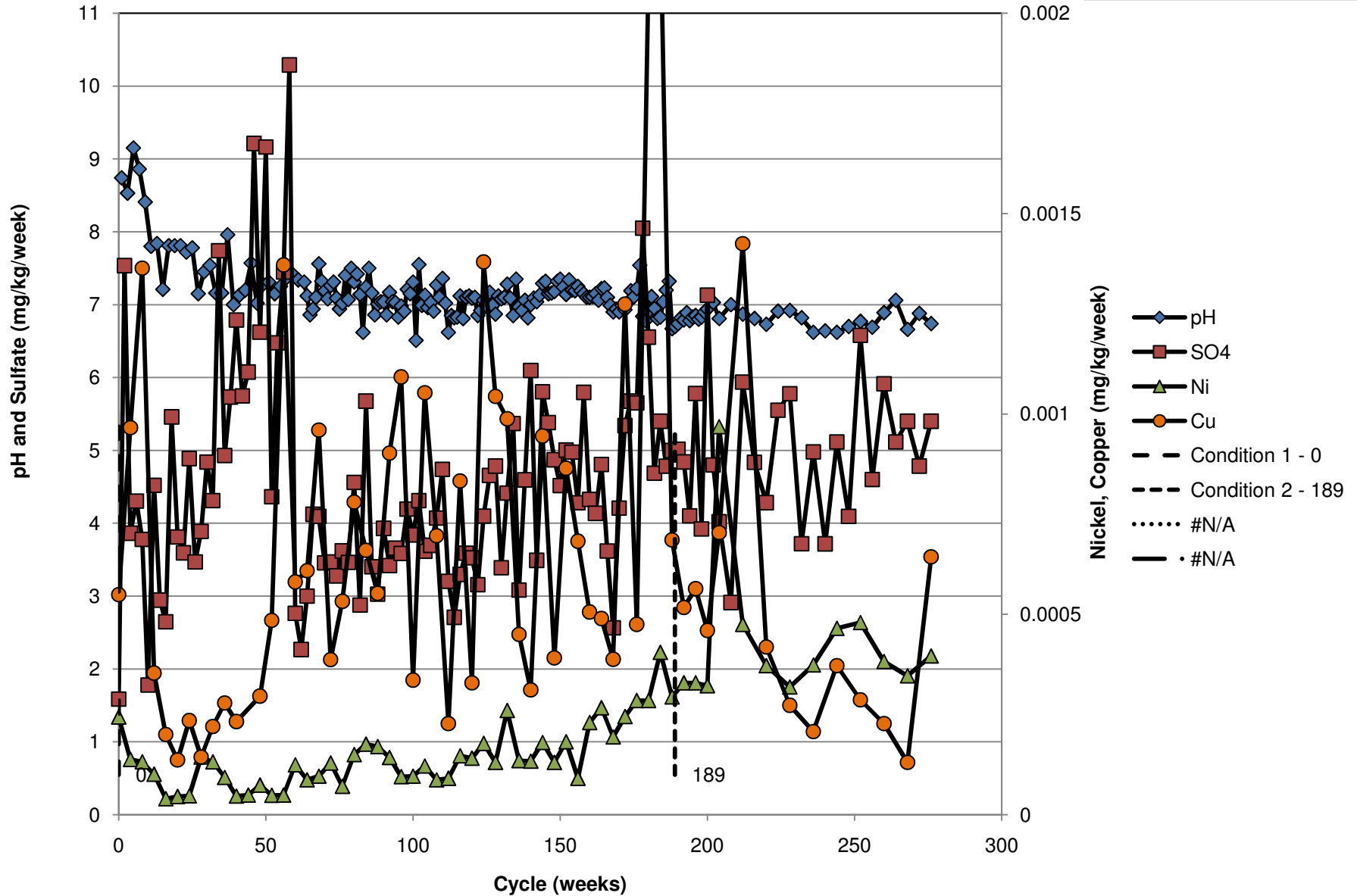

# 00-350C(580-600)

Waste Category:	2/3
Rock Type:	Troctolitic
Geology:	Duluth Complex
Sulfur:	0.19%

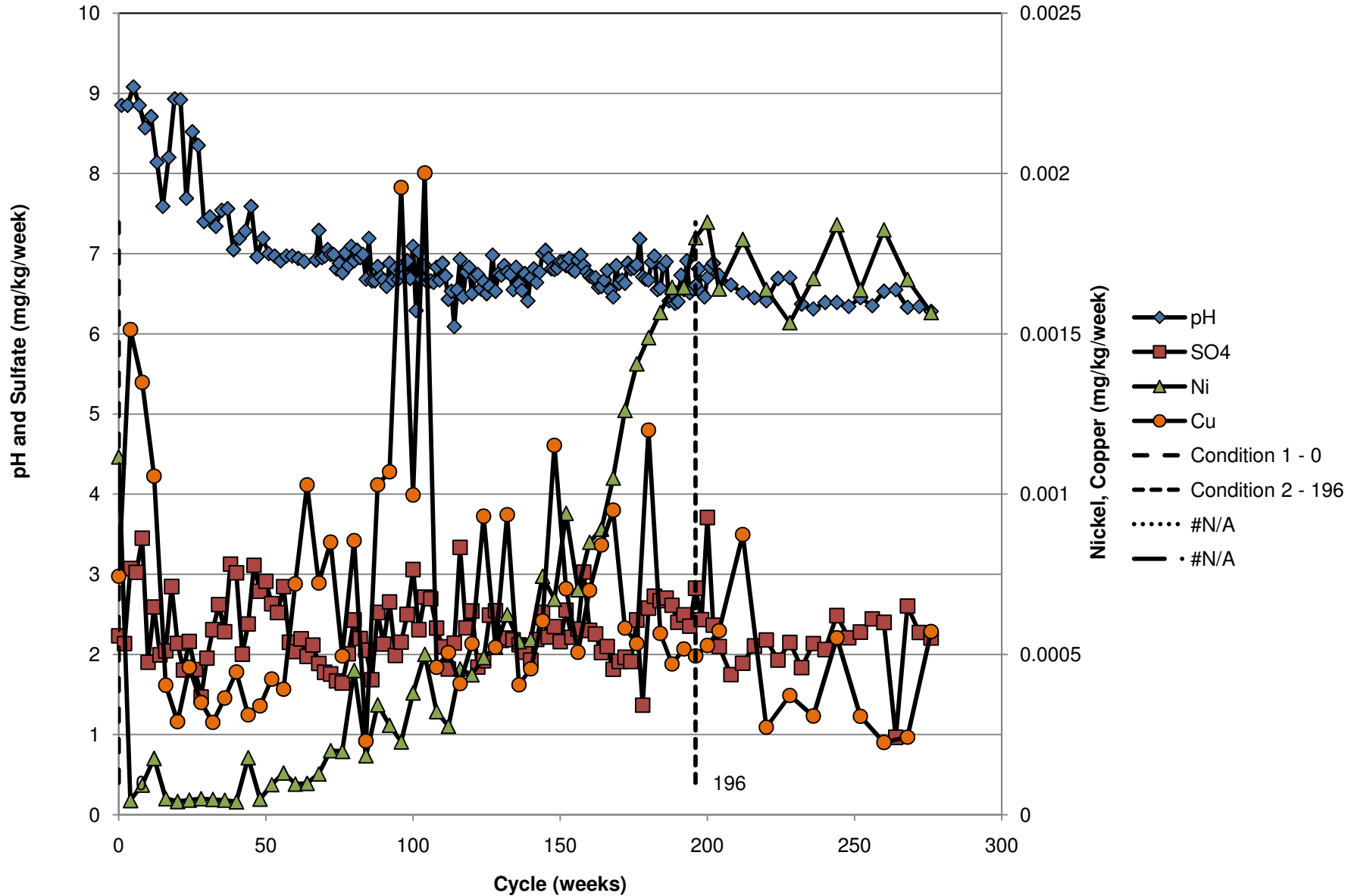

# 00-369C(335-345)

Waste Category:	2/3
Rock Type:	Troctolitic
Geology:	Duluth Complex
Sulfur:	0.18%

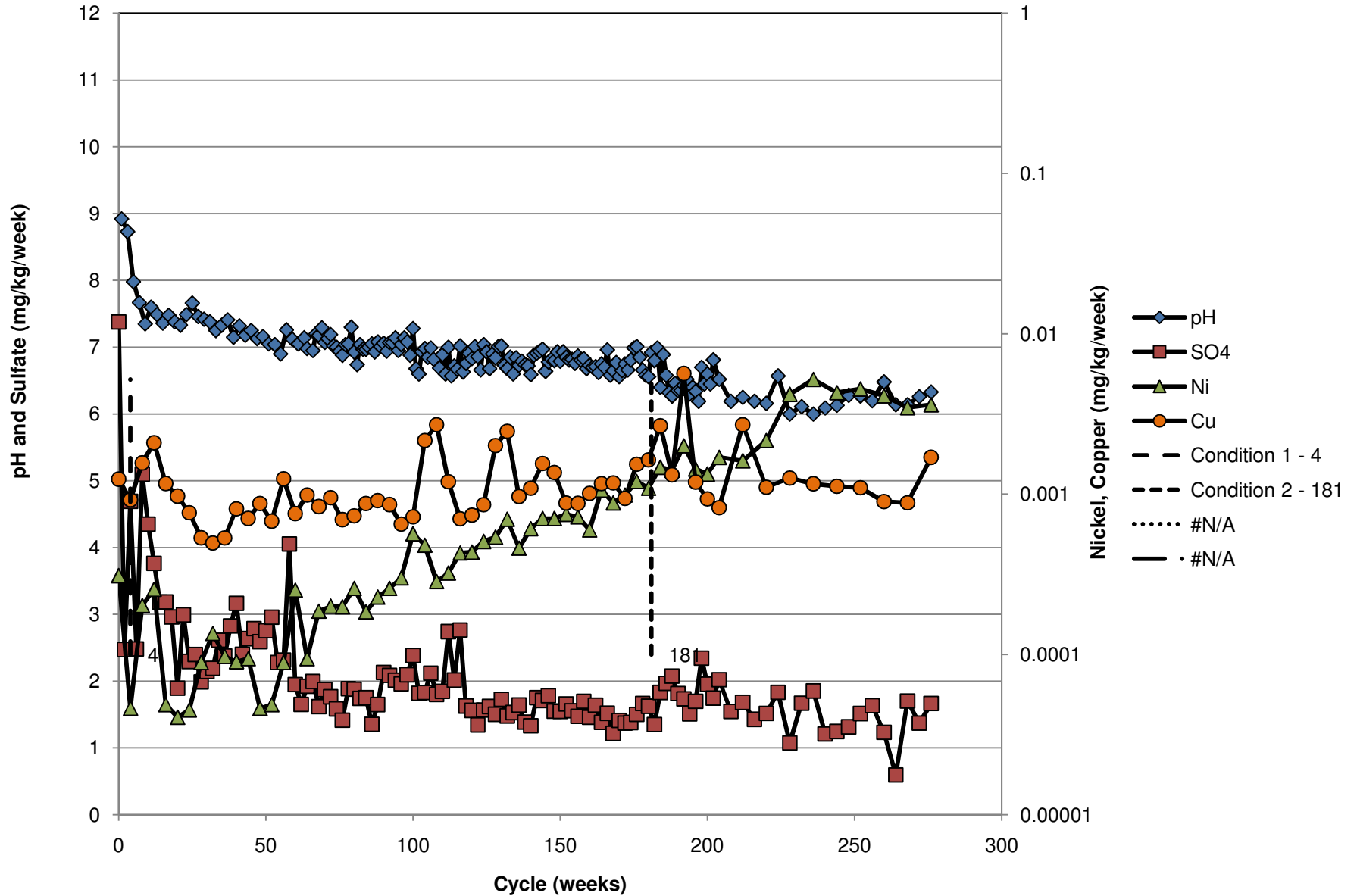

# 00-369C(305-325)

Waste Category:	2/3
Rock Type:	Troctolitic
Geology:	Duluth Complex
Sulfur:	0.25%

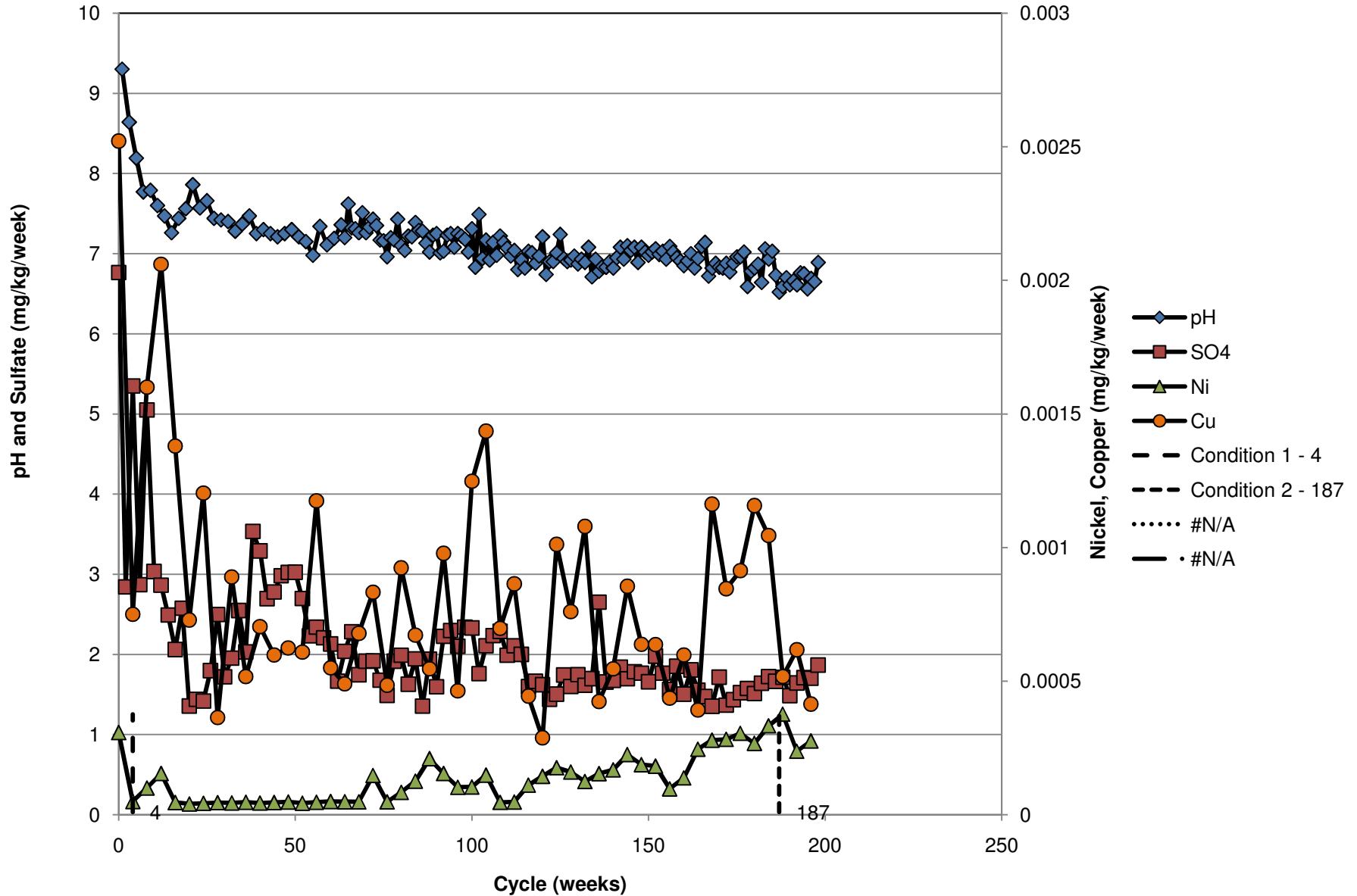



# 00-369C(20-30)

Waste Category:	2/3
Rock Type:	Troctolitic
Geology:	Duluth Complex
Sulfur:	0.21%

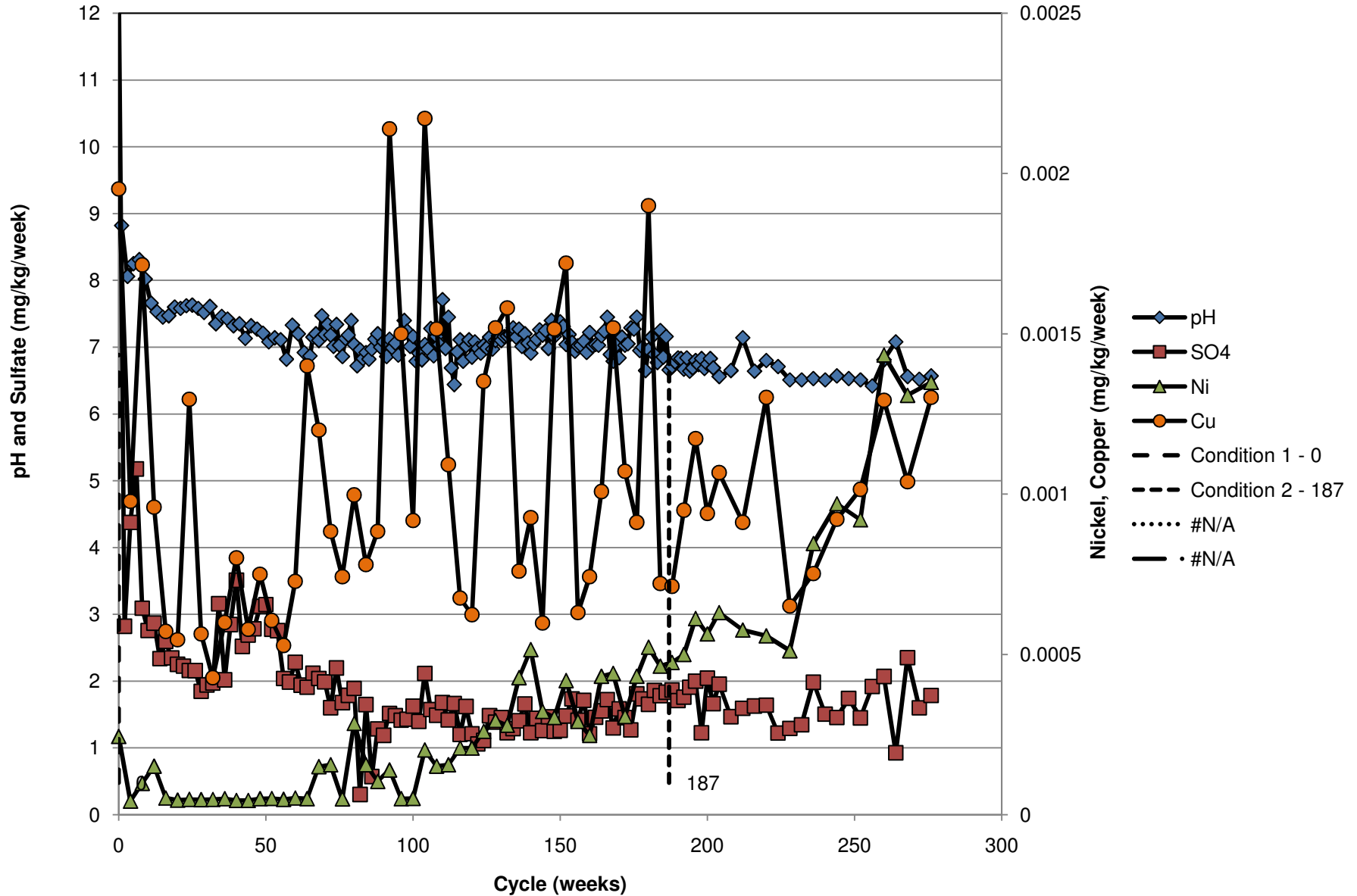

# 00-326C(60-70)

Waste Category:	2/3
Rock Type:	Troctolitic
Geology:	Duluth Complex
Sulfur:	0.14%

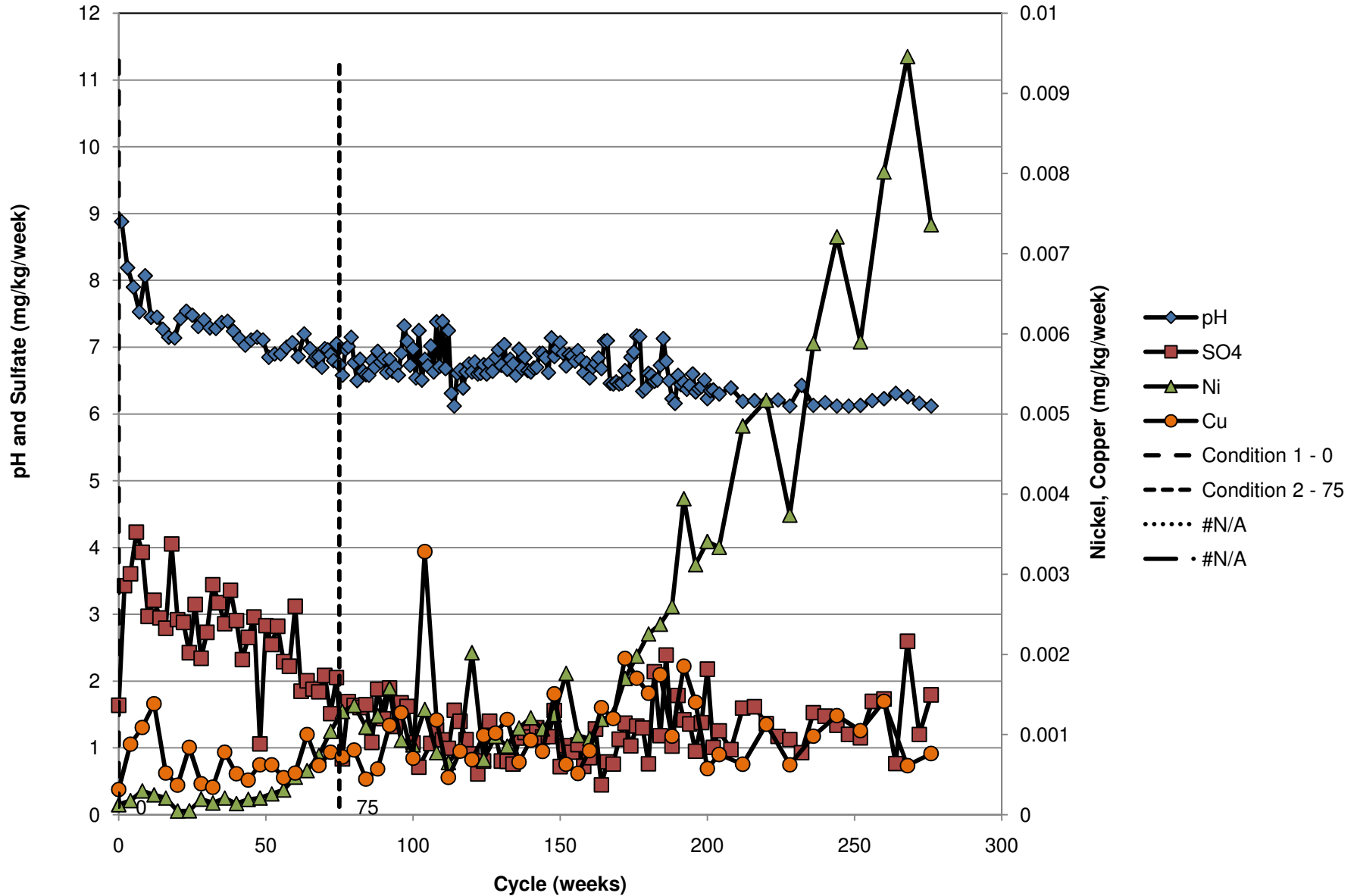

# 00-367C(170-175)

Waste Category:	2/3
Rock Type:	Troctolitic
Geology:	Duluth Complex
Sulfur:	0.51%

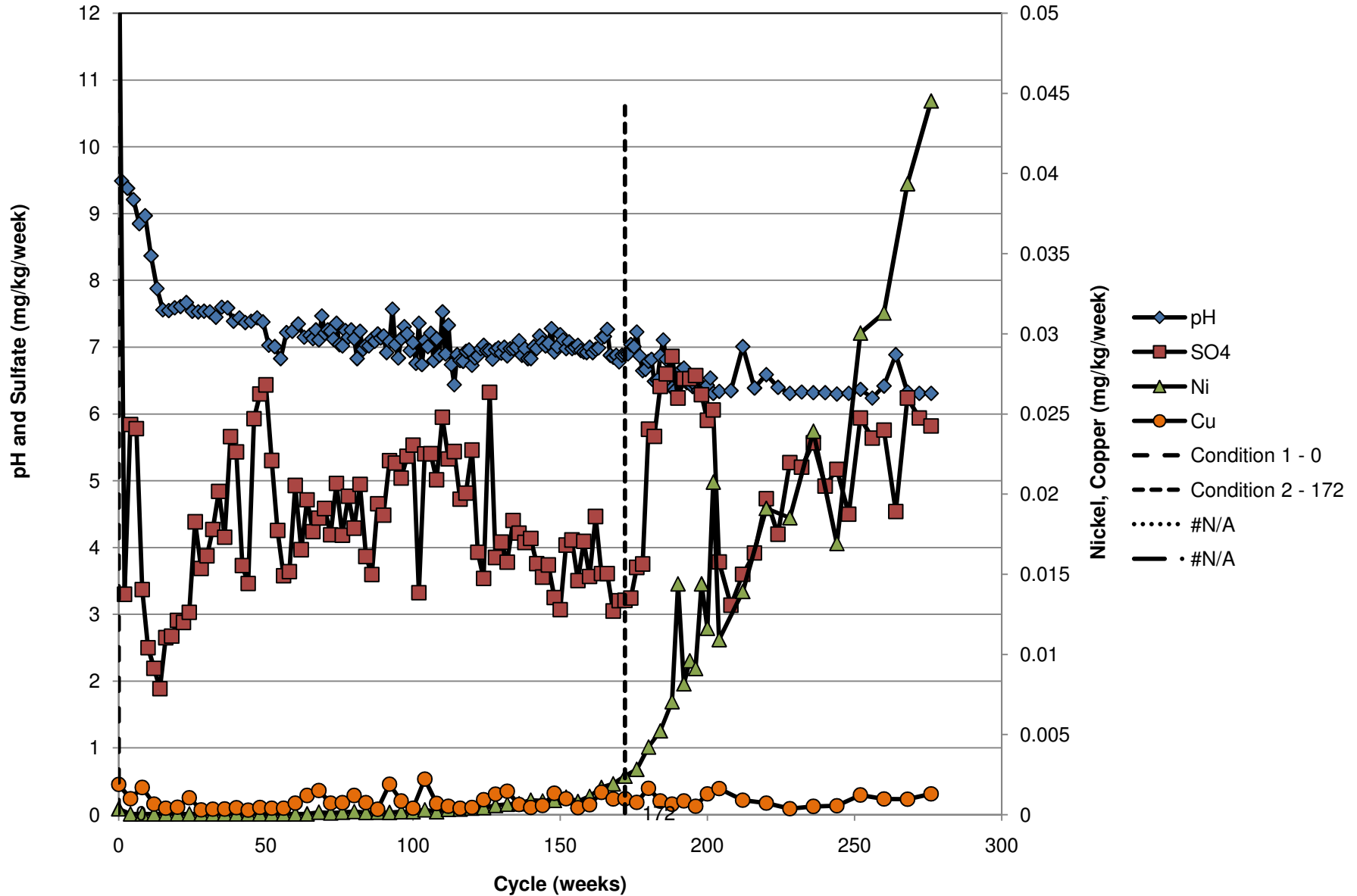

# 26056(302-312)

Waste Category:	2/3
Rock Type:	Troctolitic
Geology:	Duluth Complex
Sulfur:	0.23%

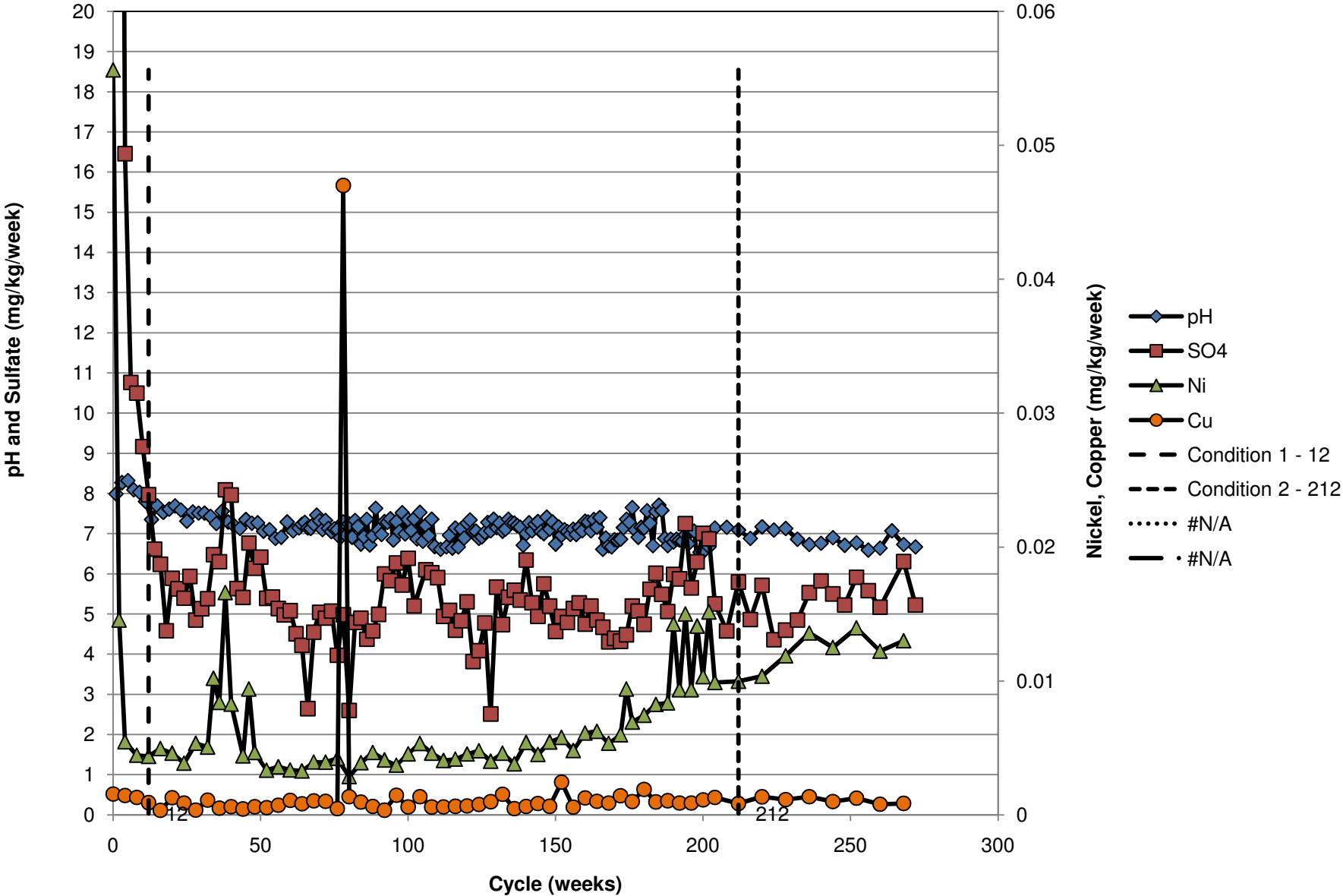

# 26142(360+345-365+350)

Waste Category:	2/3
Rock Type:	Troctolitic
Geology:	Duluth Complex
Sulfur:	0.18%

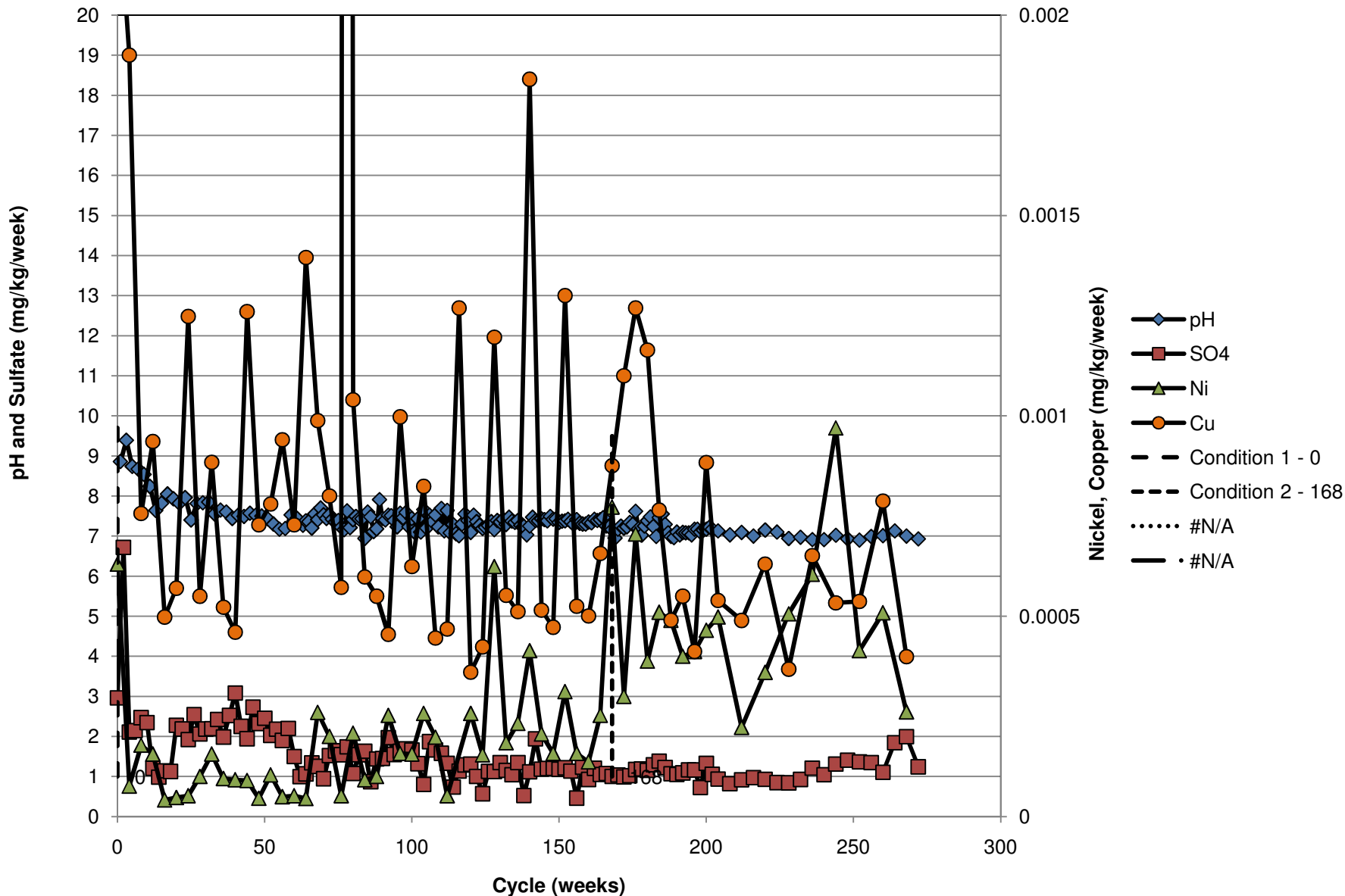

# 99-318C(325-330)

Waste Category:	2/3
Rock Type:	Troctolitic
Geology:	Duluth Complex
Sulfur:	0.17%

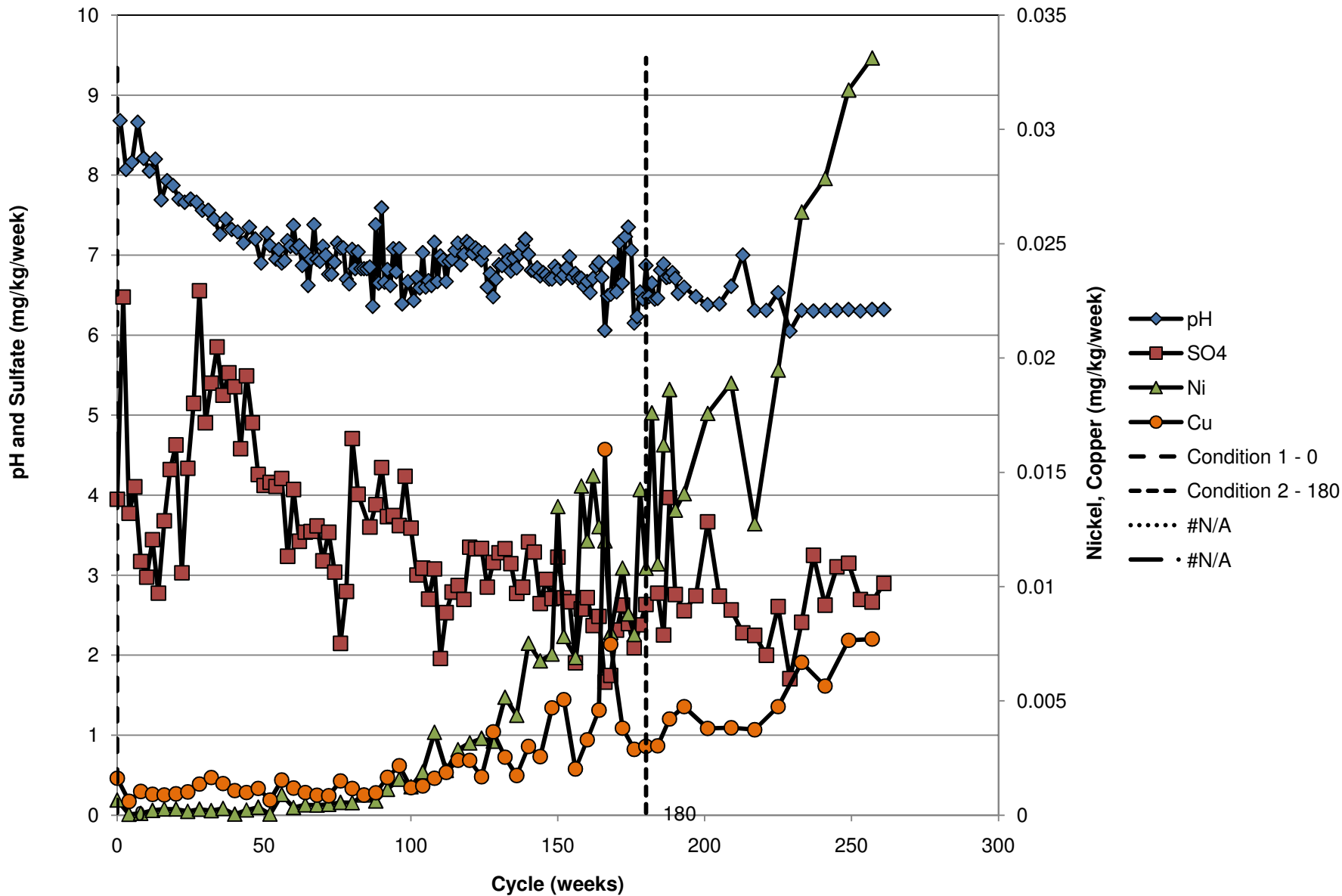

# 00-340C(910-925)

Waste Category:	2/3
Rock Type:	Troctolitic
Geology:	Duluth Complex
Sulfur:	0.36%

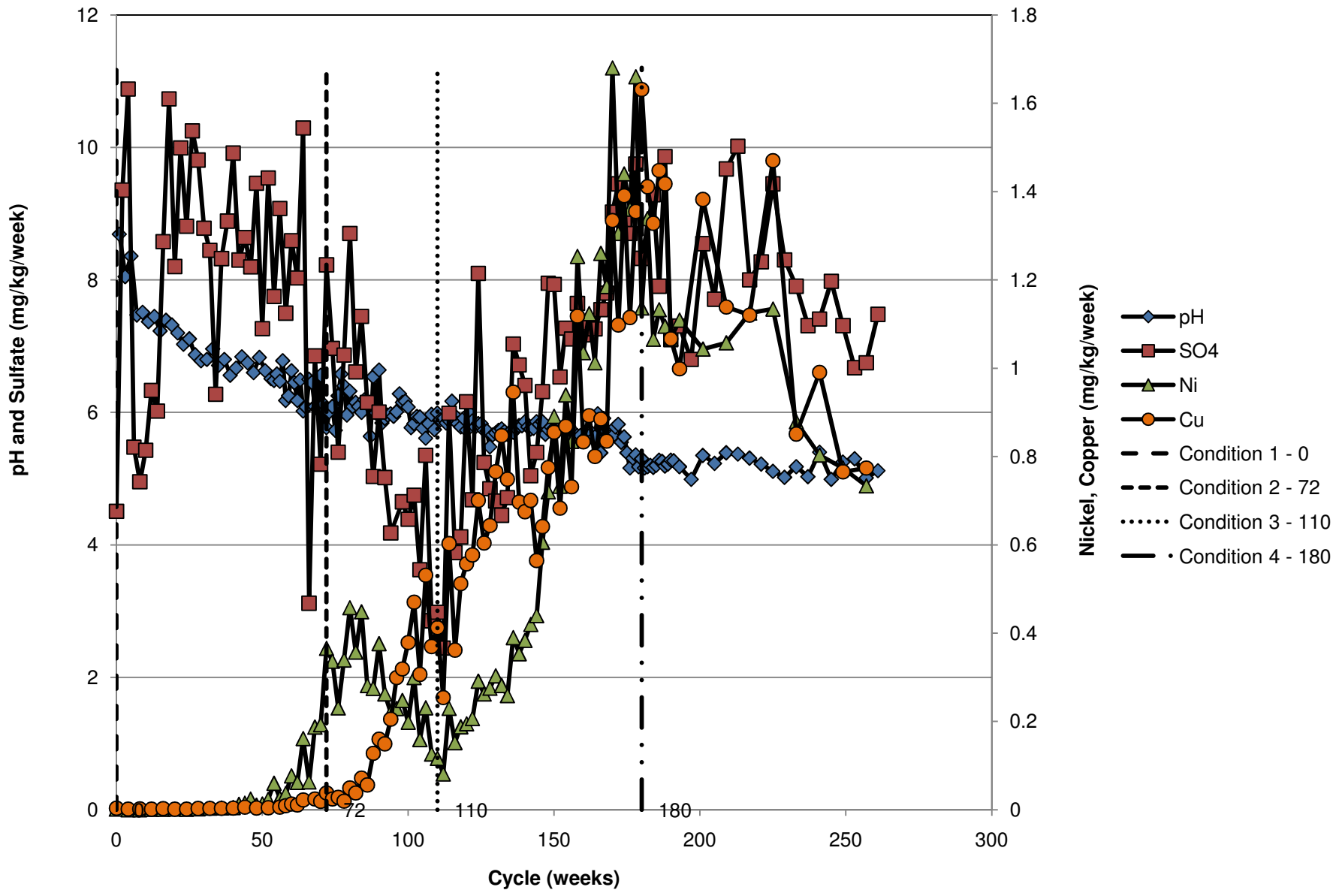

# 00-331C(190-210)

Waste Category:	2/3
Rock Type:	Troctolitic
Geology:	Duluth Complex
Sulfur:	0.42%

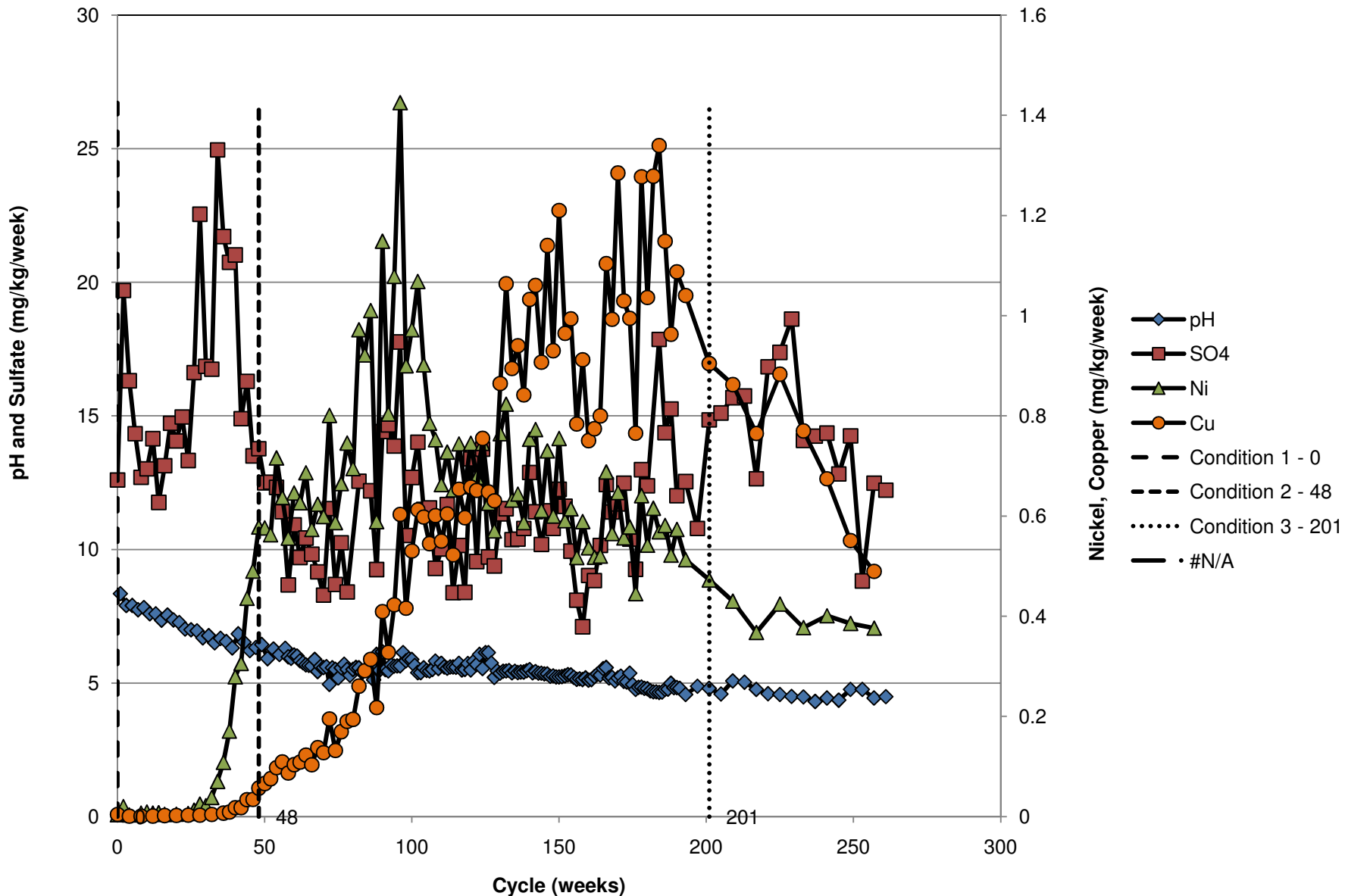



# 00-367C(495-500)

Waste Category:	2/3
Rock Type:	Troctolitic
Geology:	Duluth Complex
Sulfur:	0.28%

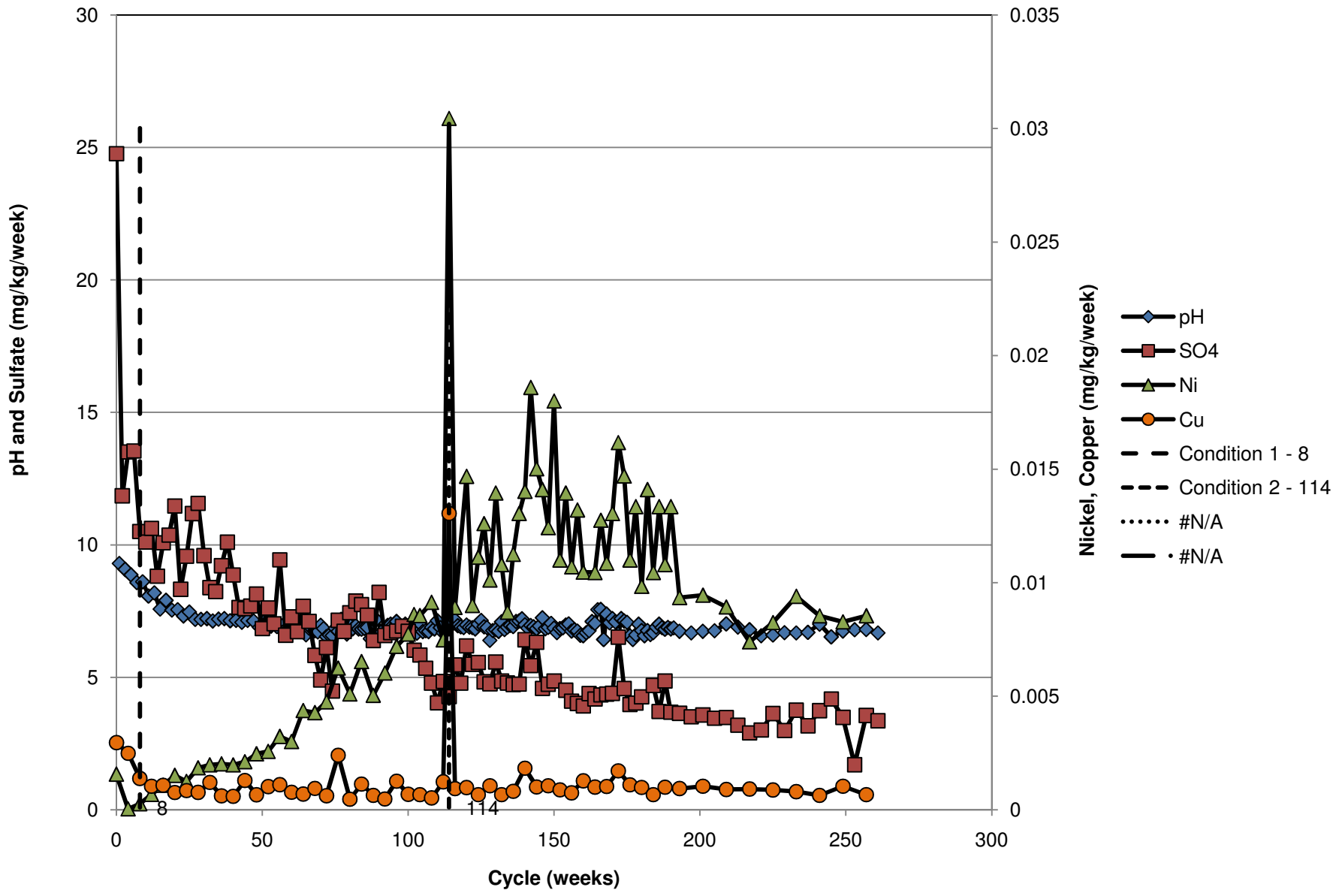

# 00-327C(225-245)

Waste Category:	2/3
Rock Type:	Troctolitic
Geology:	Duluth Complex
Sulfur:	0.44%

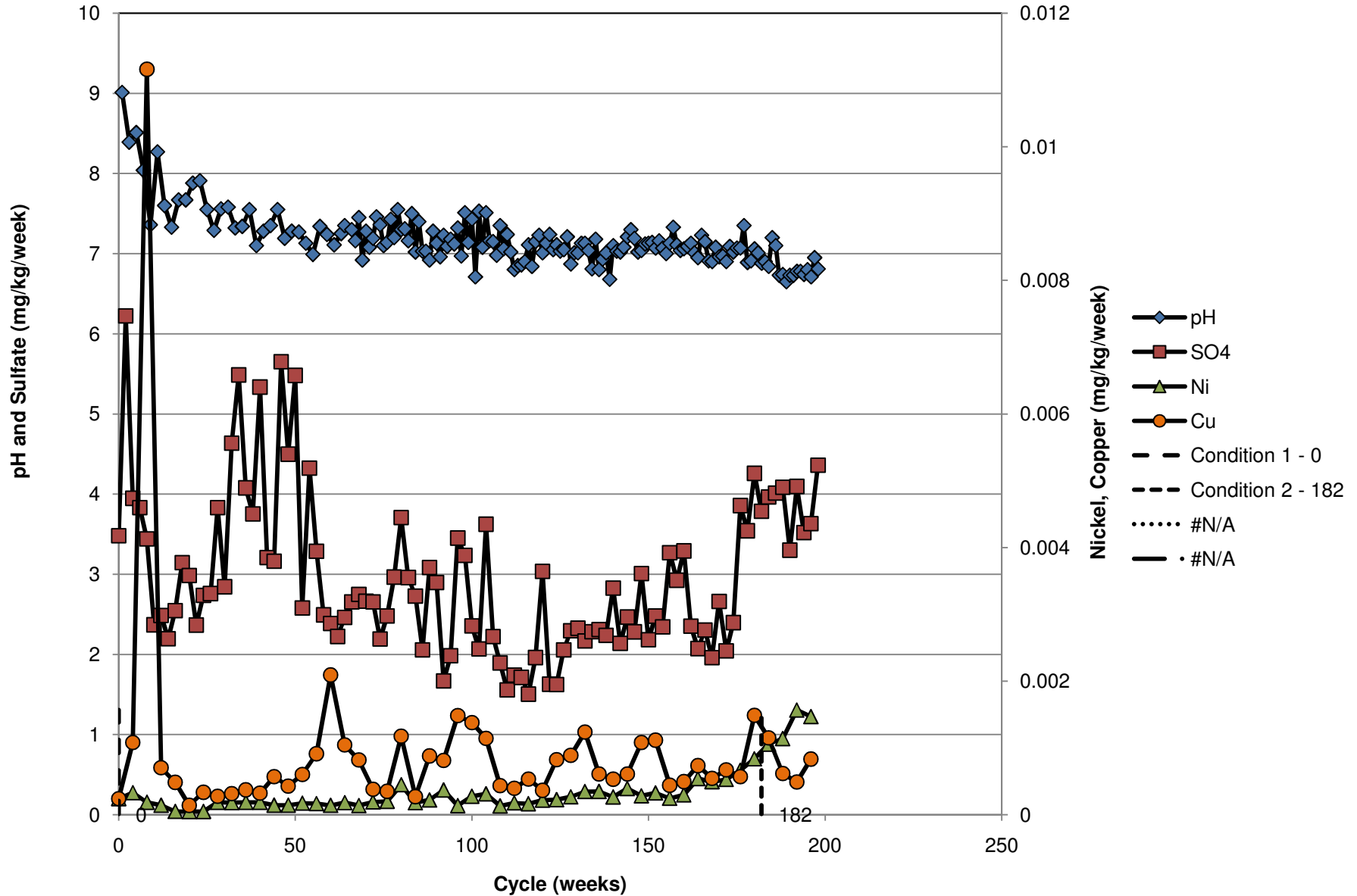

# 00-340C(380-390)

Waste Category:	2/3
Rock Type:	Troctolitic
Geology:	Duluth Complex
Sulfur:	0.15%

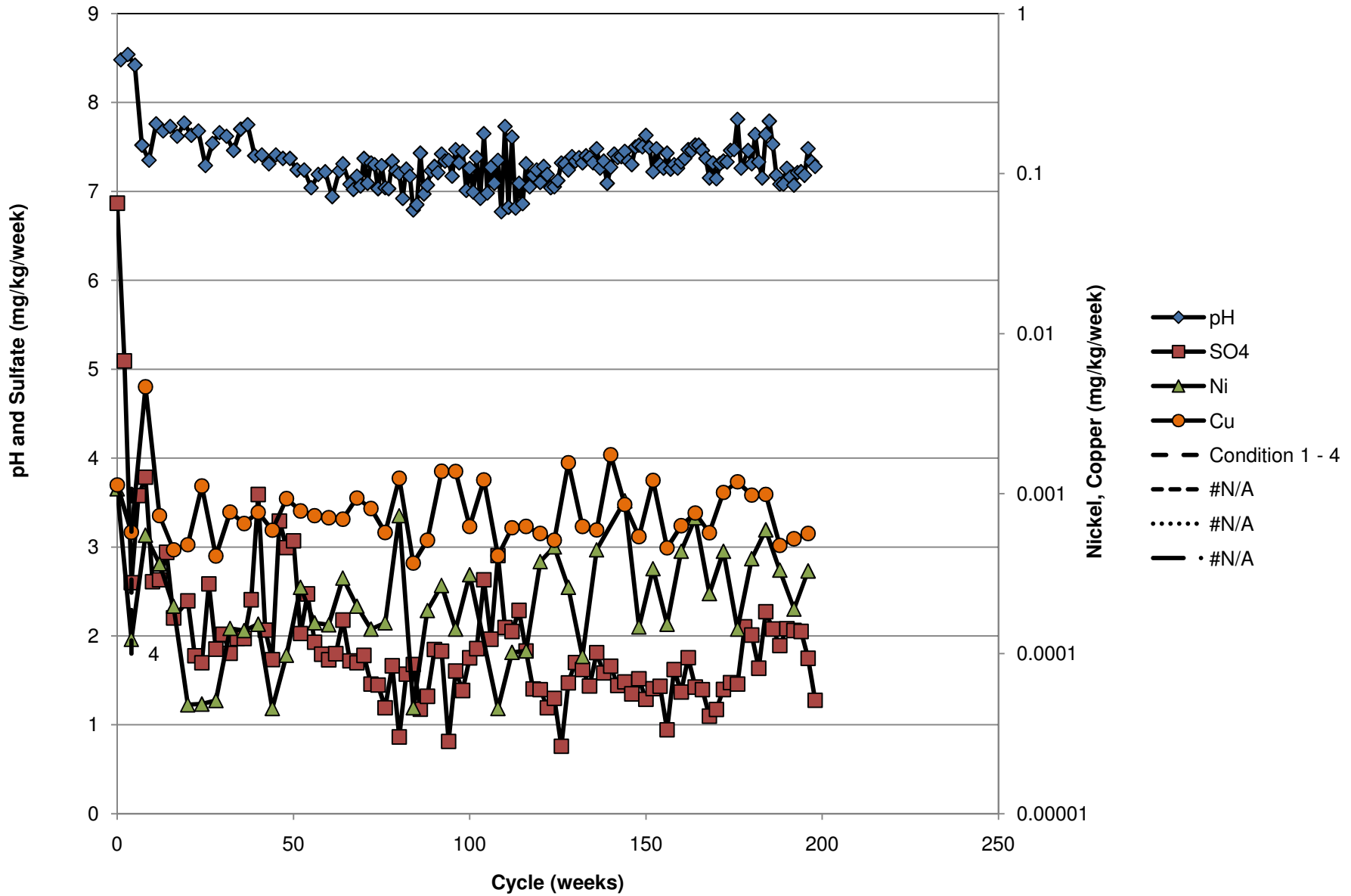

# 26049+26030

Waste Category: 2/3  
Rock Type: Troctolitic  
Geology: Duluth Complex  
Sulfur: 0.59%

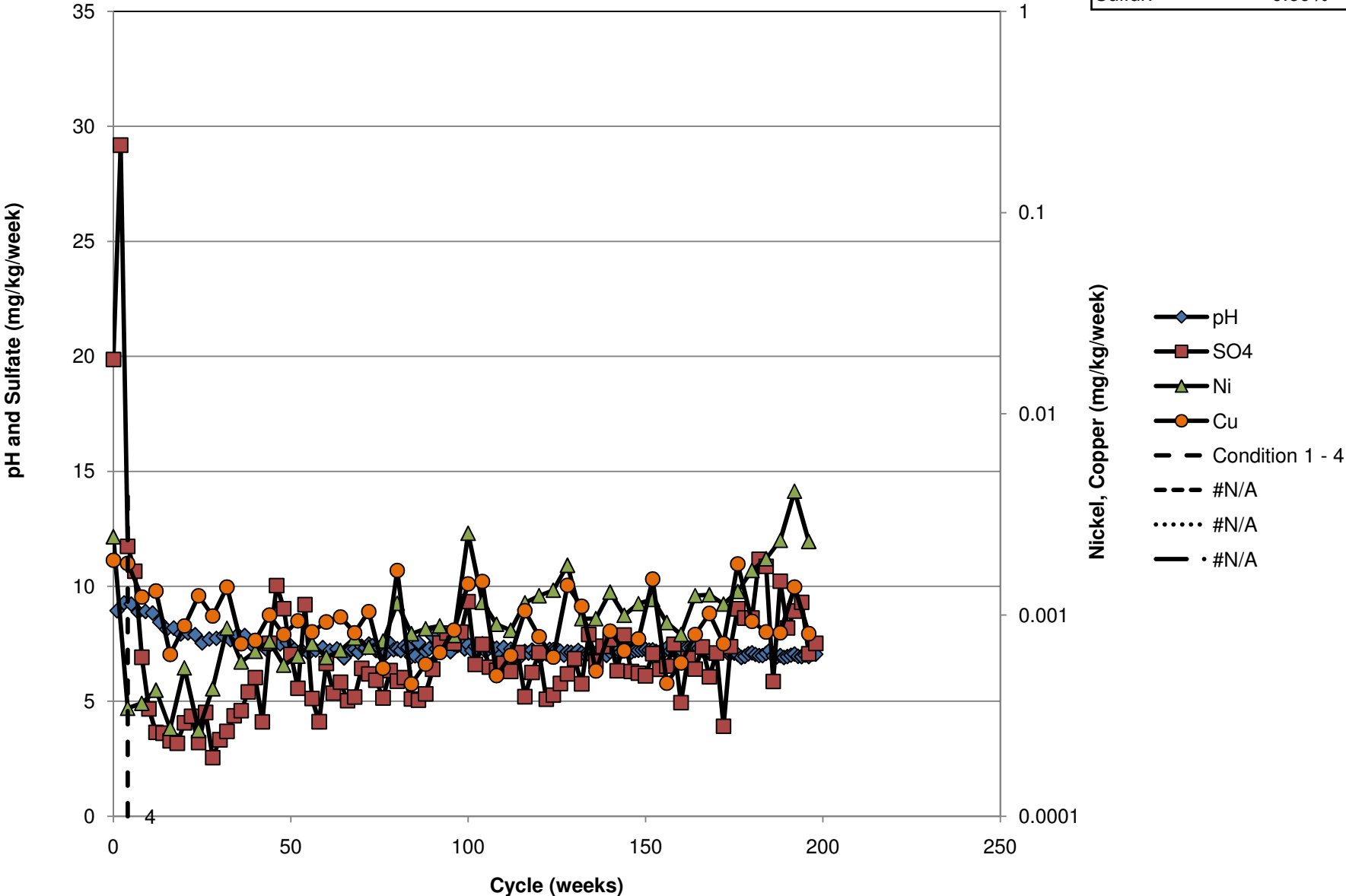

# 26056(282-292)

Waste Category:	2/3
Rock Type:	Troctolitic
Geology:	Duluth Complex
Sulfur:	0.32%

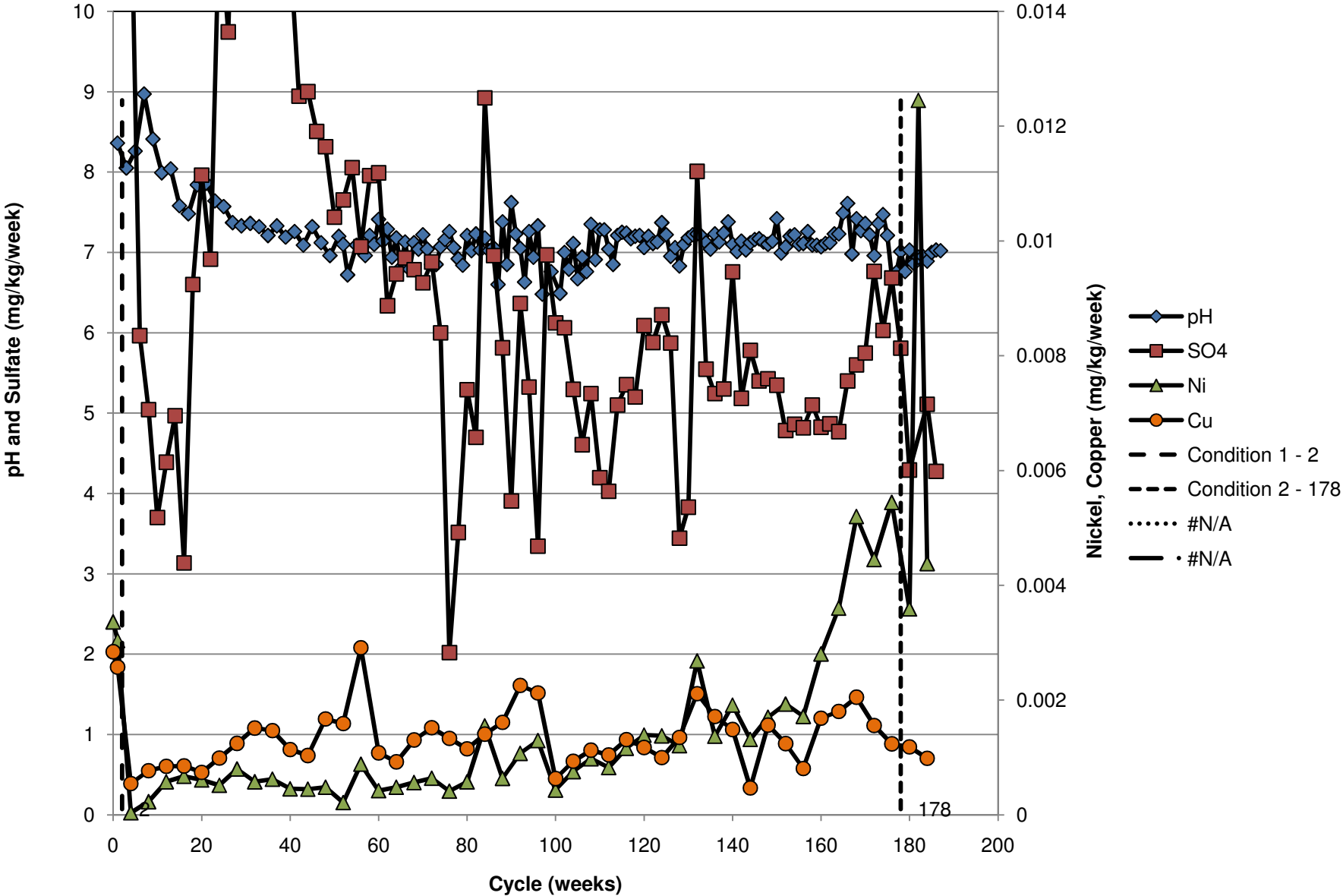

# 00-357C(535-540)

Waste Category:	2/3
Rock Type:	Ultramafic
Geology:	Duluth Complex
Sulfur:	0.20%

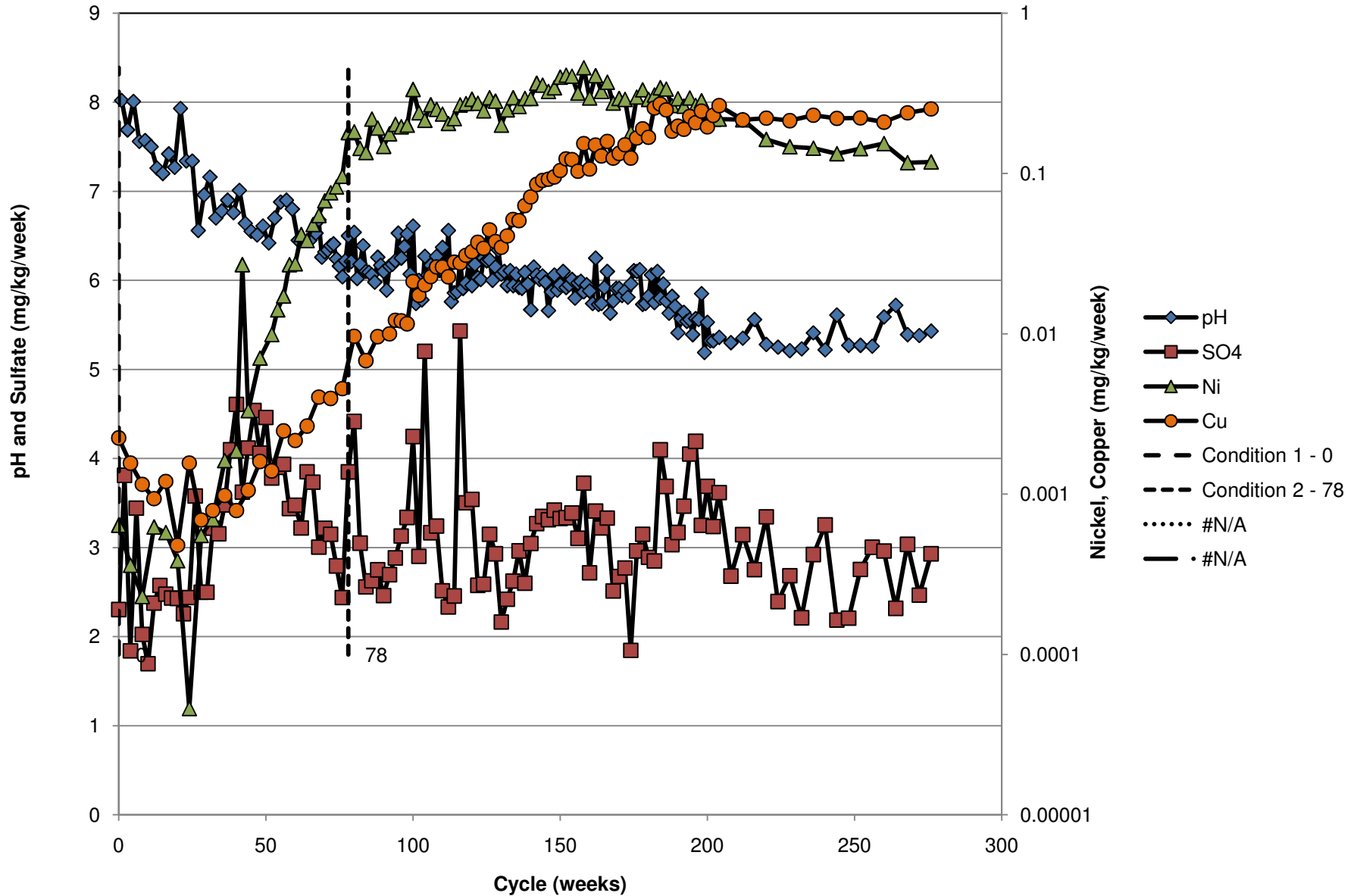

# 00-326C(680-685)

Waste Category:	2/3
Rock Type:	Ultramafic
Geology:	Duluth Complex
Sulfur:	0.30%

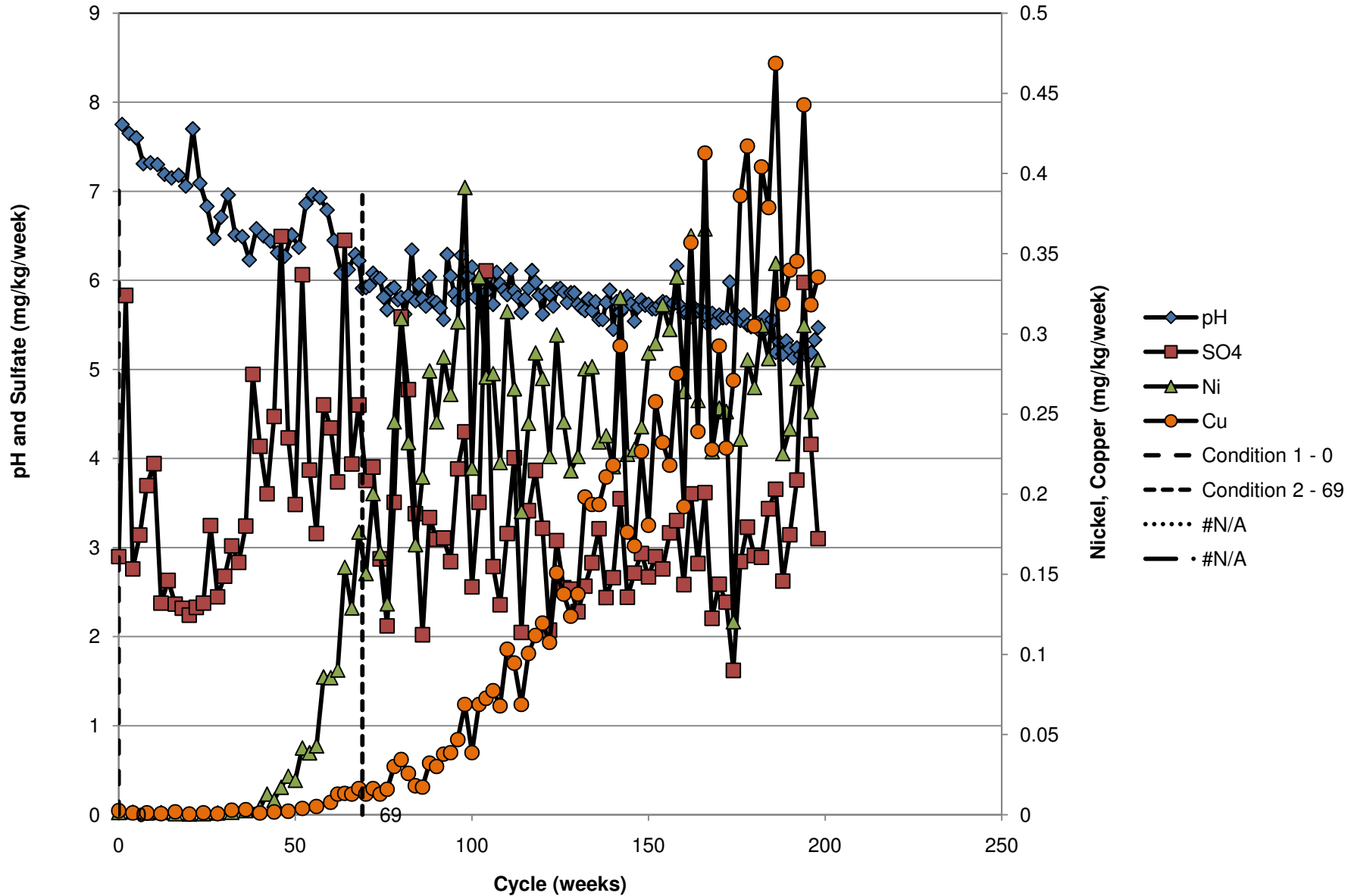

# 00-344C(630-635)

Waste Category:	2/3
Rock Type:	Ultramafic
Geology:	Duluth Complex
Sulfur:	0.34%

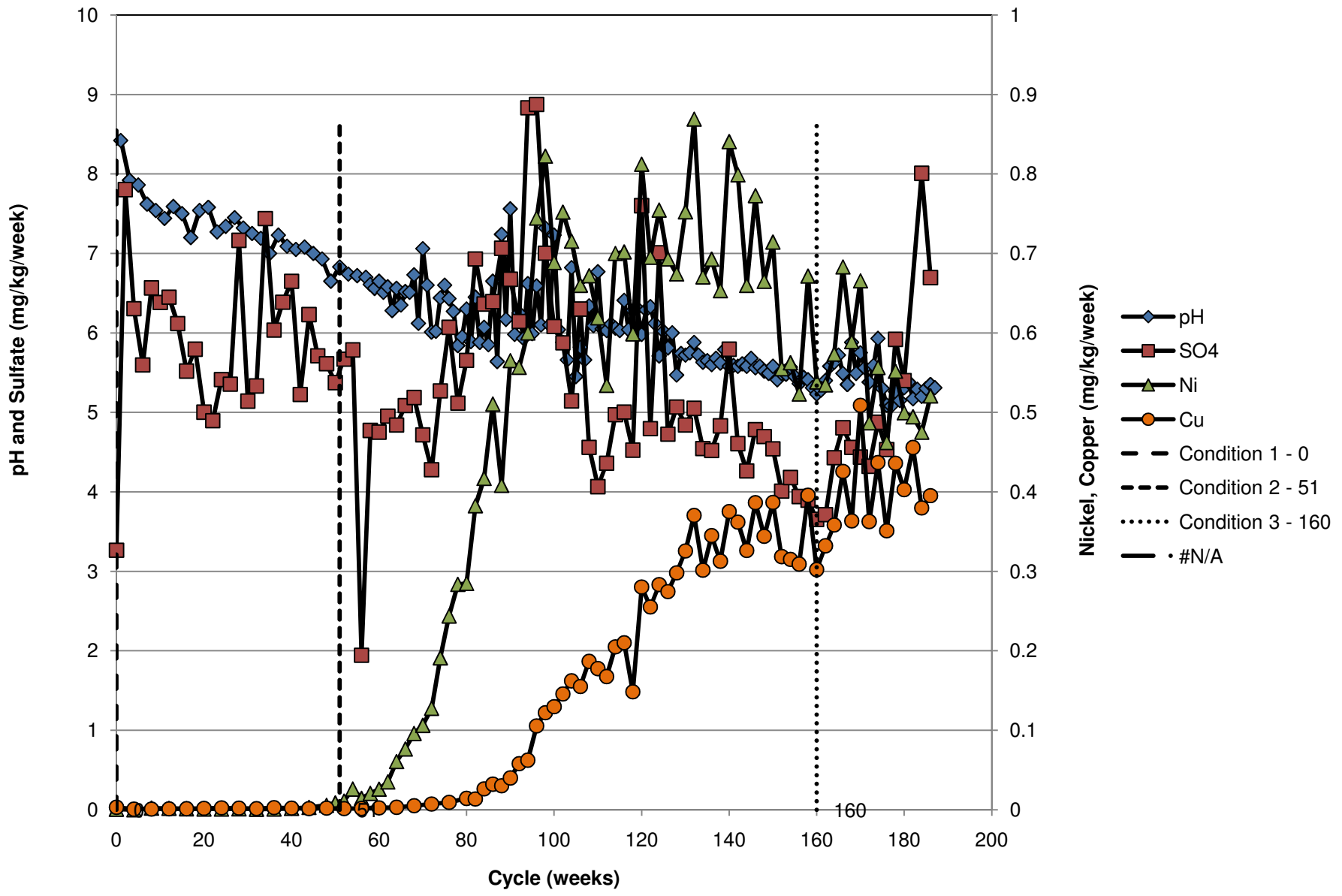



# 00-326C(495-505)

Waste Category:	2/3
Rock Type:	Ultramafic
Geology:	Duluth Complex
Sulfur:	0.16%

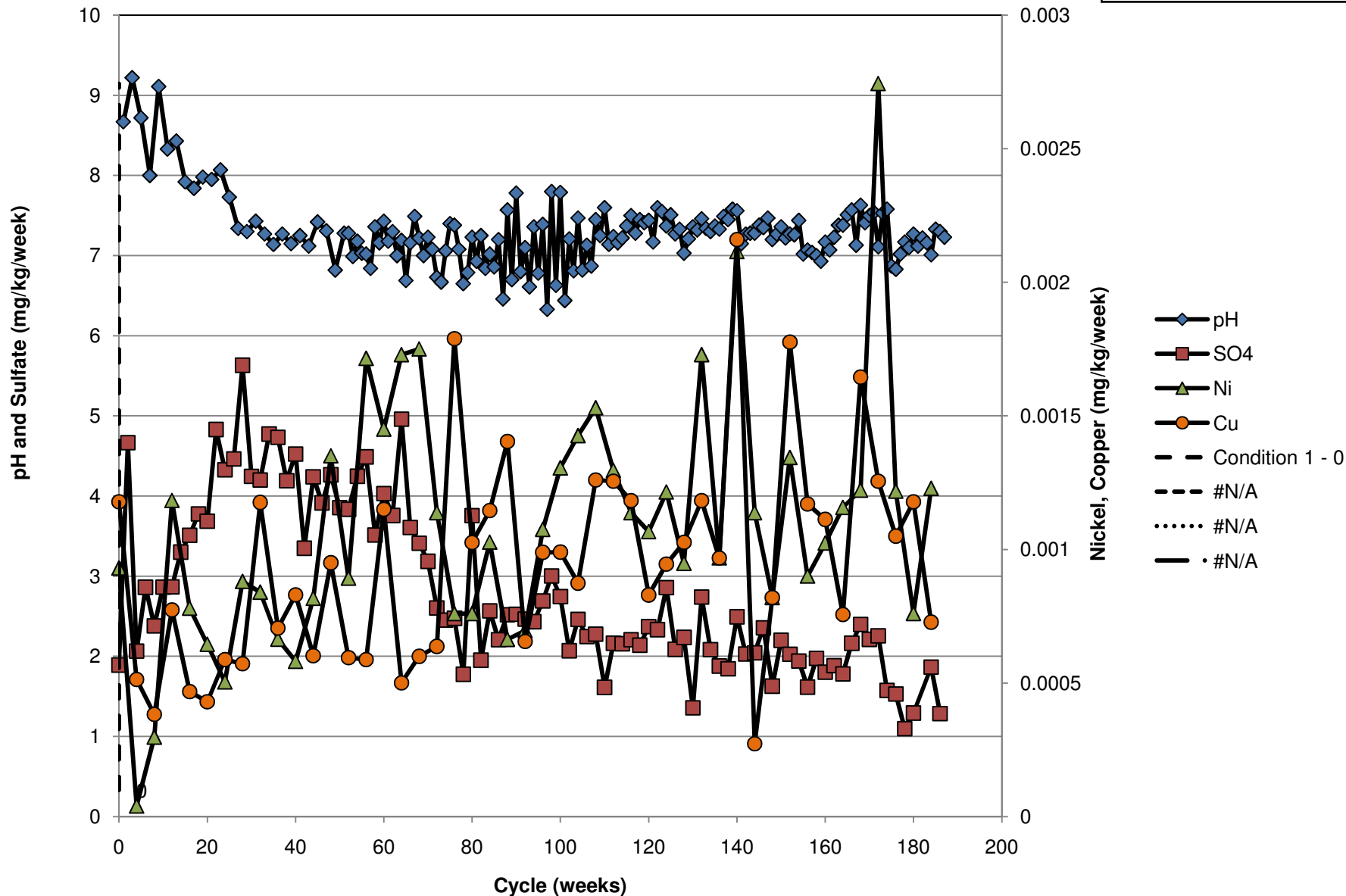

**c. Category 4 (Duluth Complex)**

# 26027(616-626)

Waste Category:	4
Rock Type:	Anorthositic
Geology:	Duluth Complex
Sulfur:	1.83%

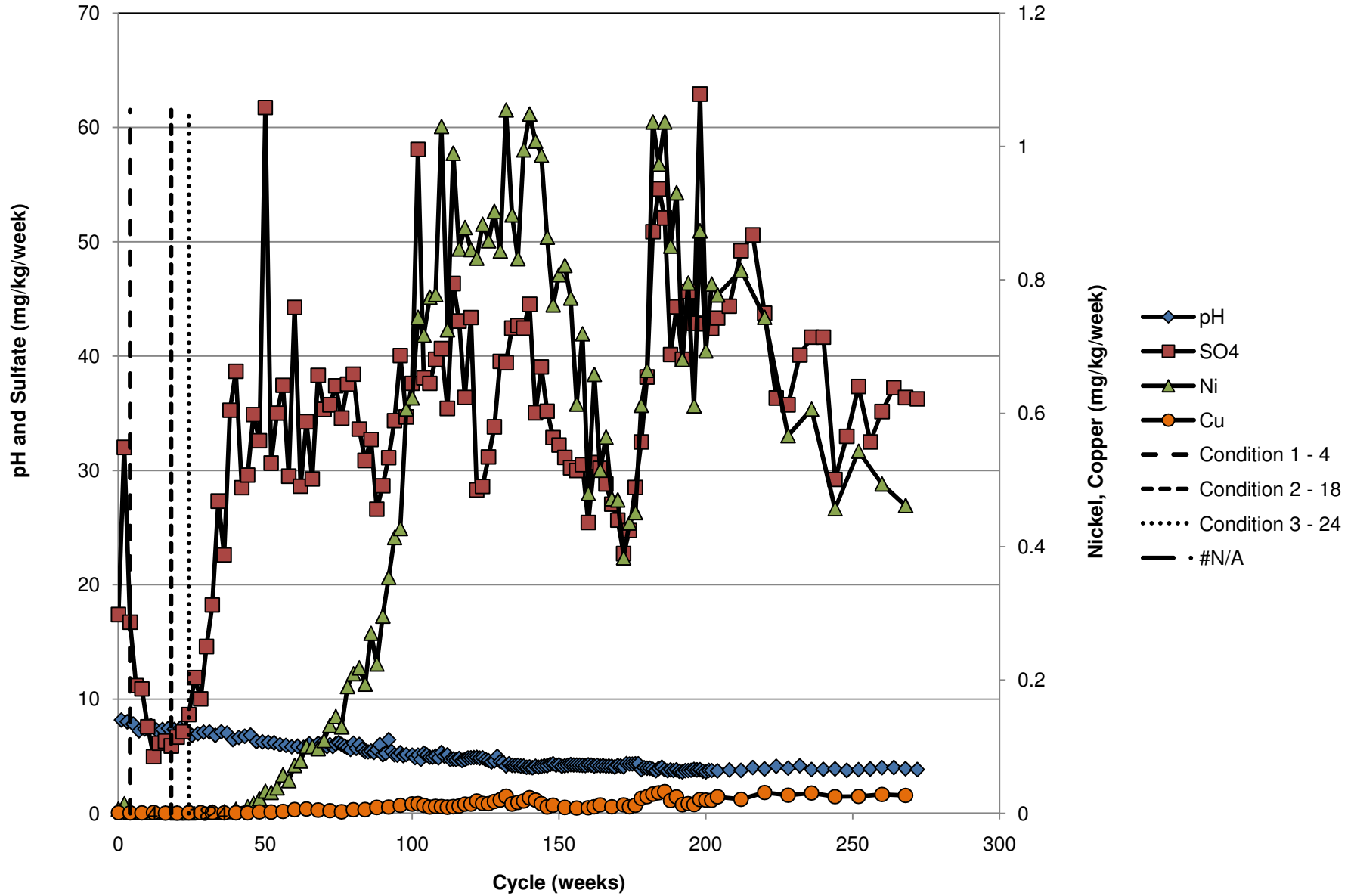

# 00-331C(255-260)

Waste Category:	4
Rock Type:	Anorthositic
Geology:	Duluth Complex
Sulfur:	0.86%

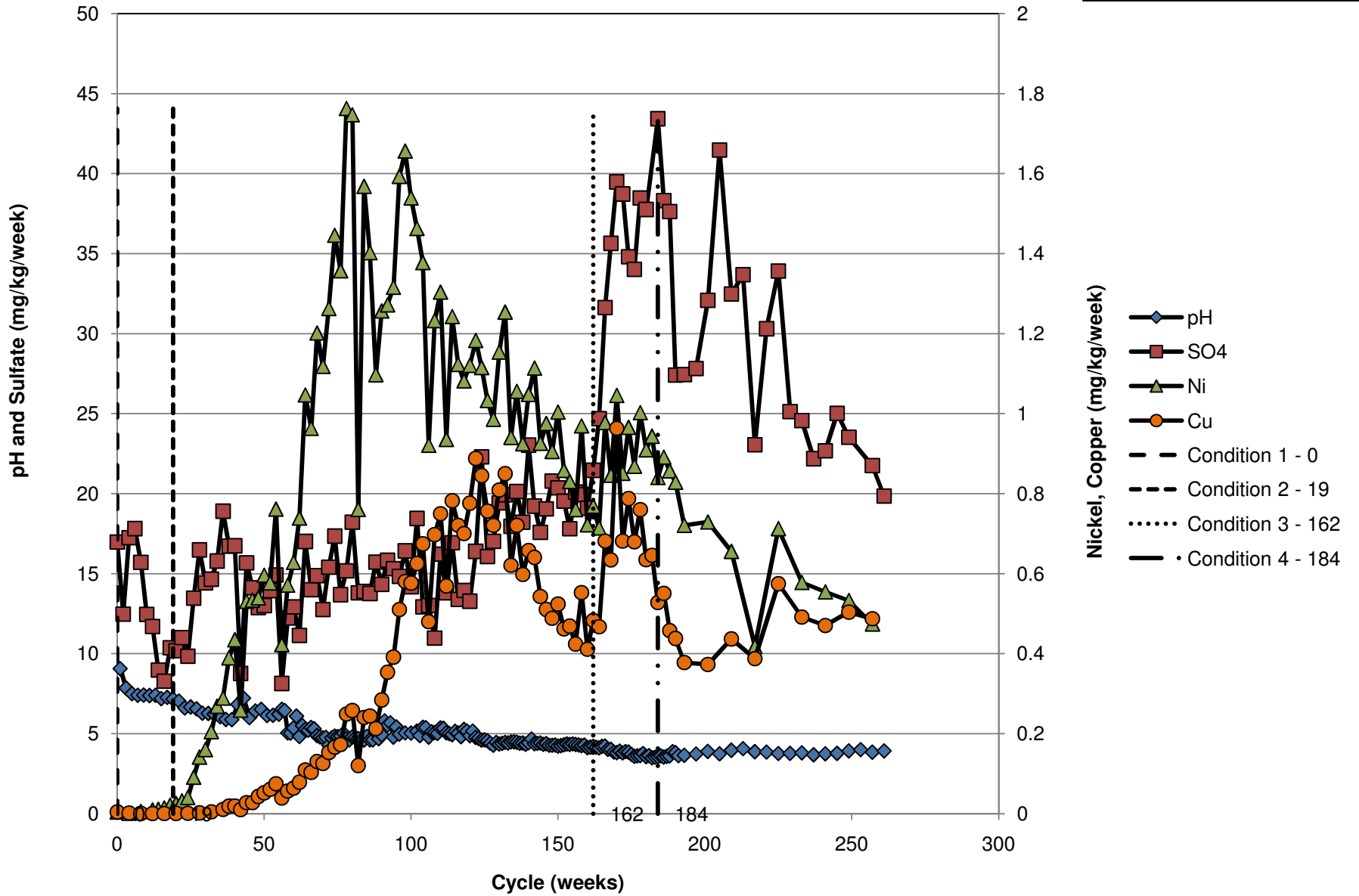

# 00-343C(240-250)

Waste Category:	4
Rock Type:	Anorthositic
Geology:	Duluth Complex
Sulfur:	0.68%

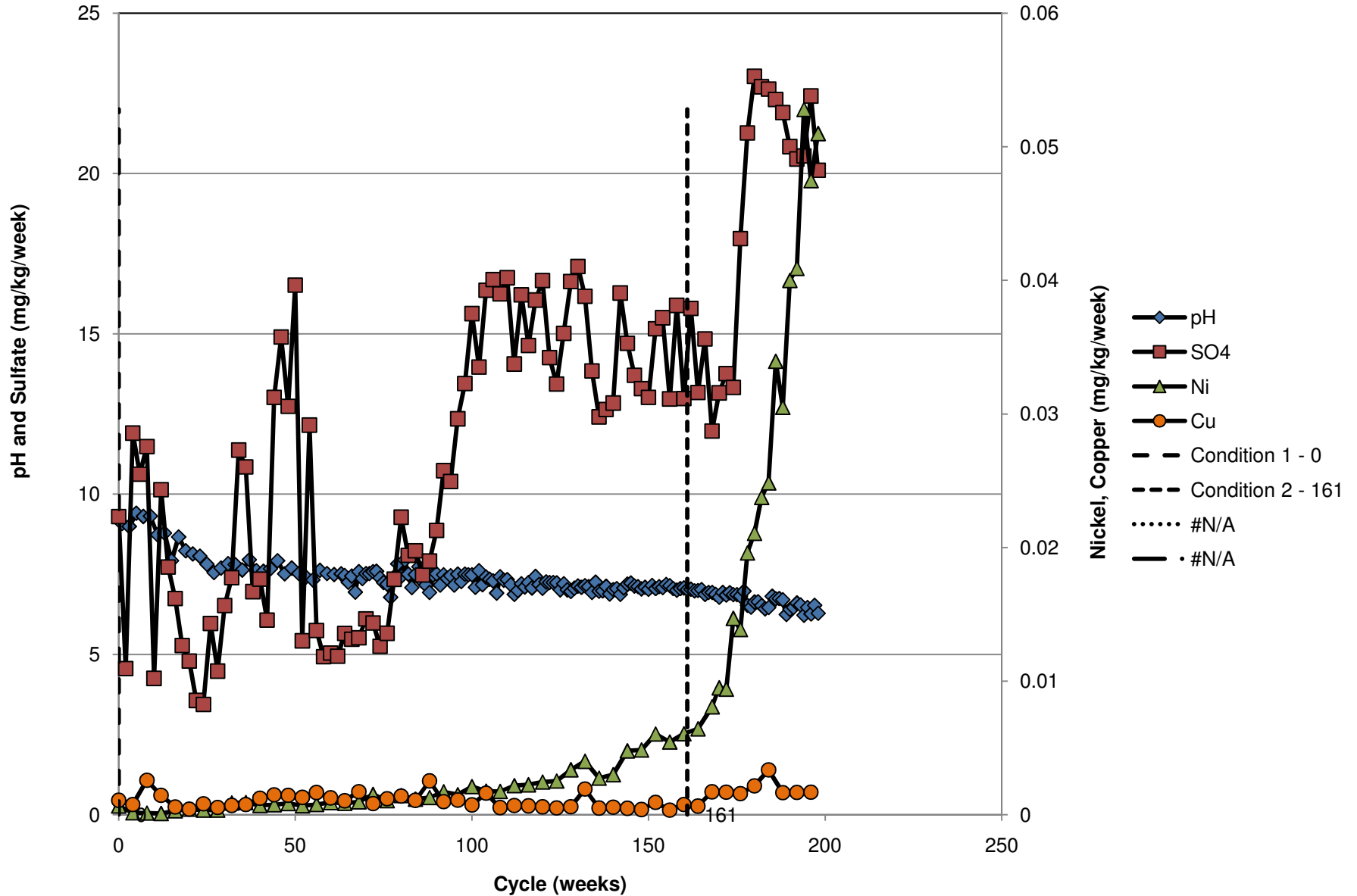

# 26043+26027

Waste Category:	4
Rock Type:	Sedimentary Hornfels
Geology:	Duluth Complex
Sulfur:	2.47%

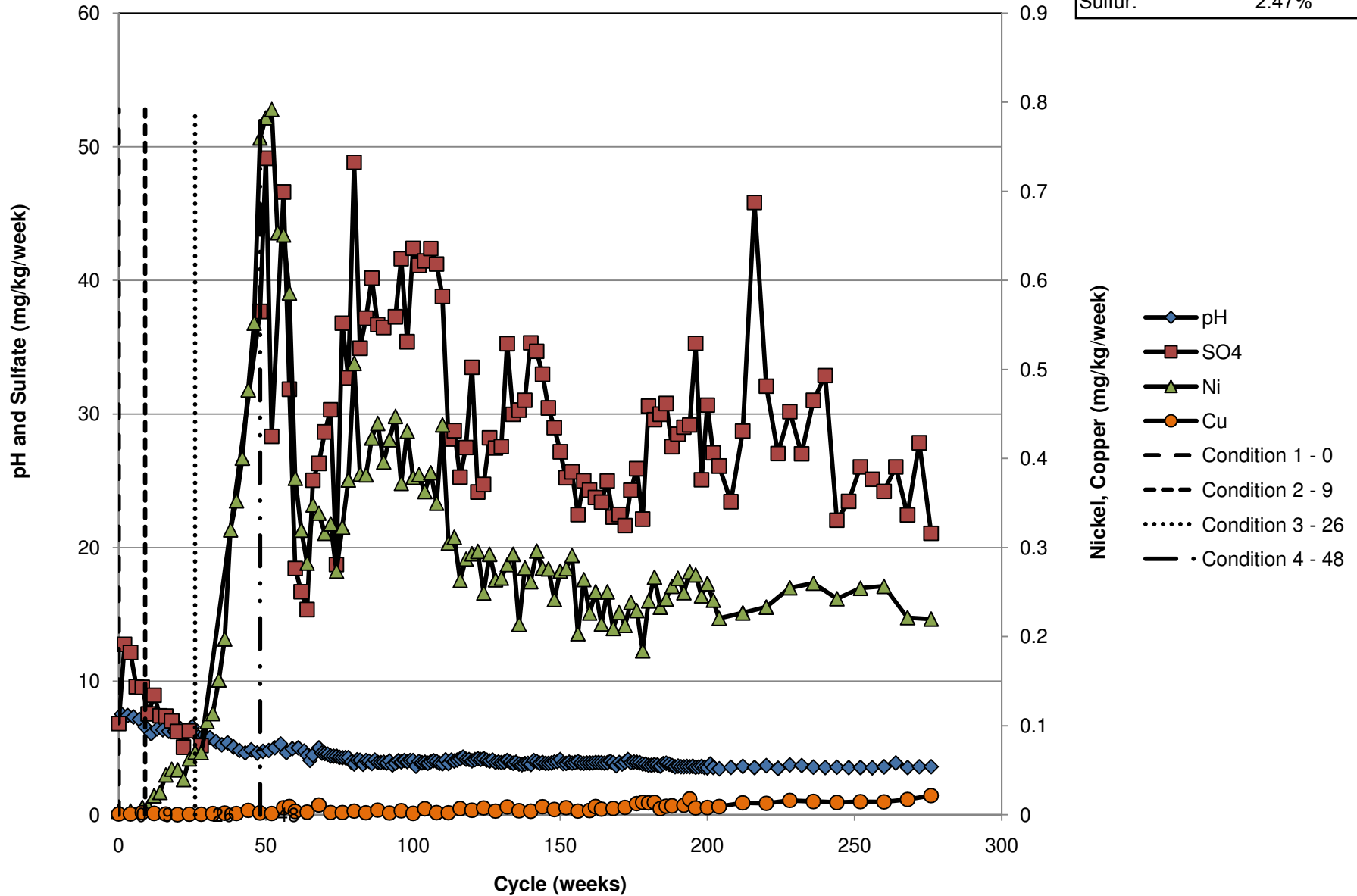

# 26062+26026

Waste Category: 4  
Rock Type: Sedimentary Hornfels  
Geology: Duluth Complex  
Sulfur: 4.46%

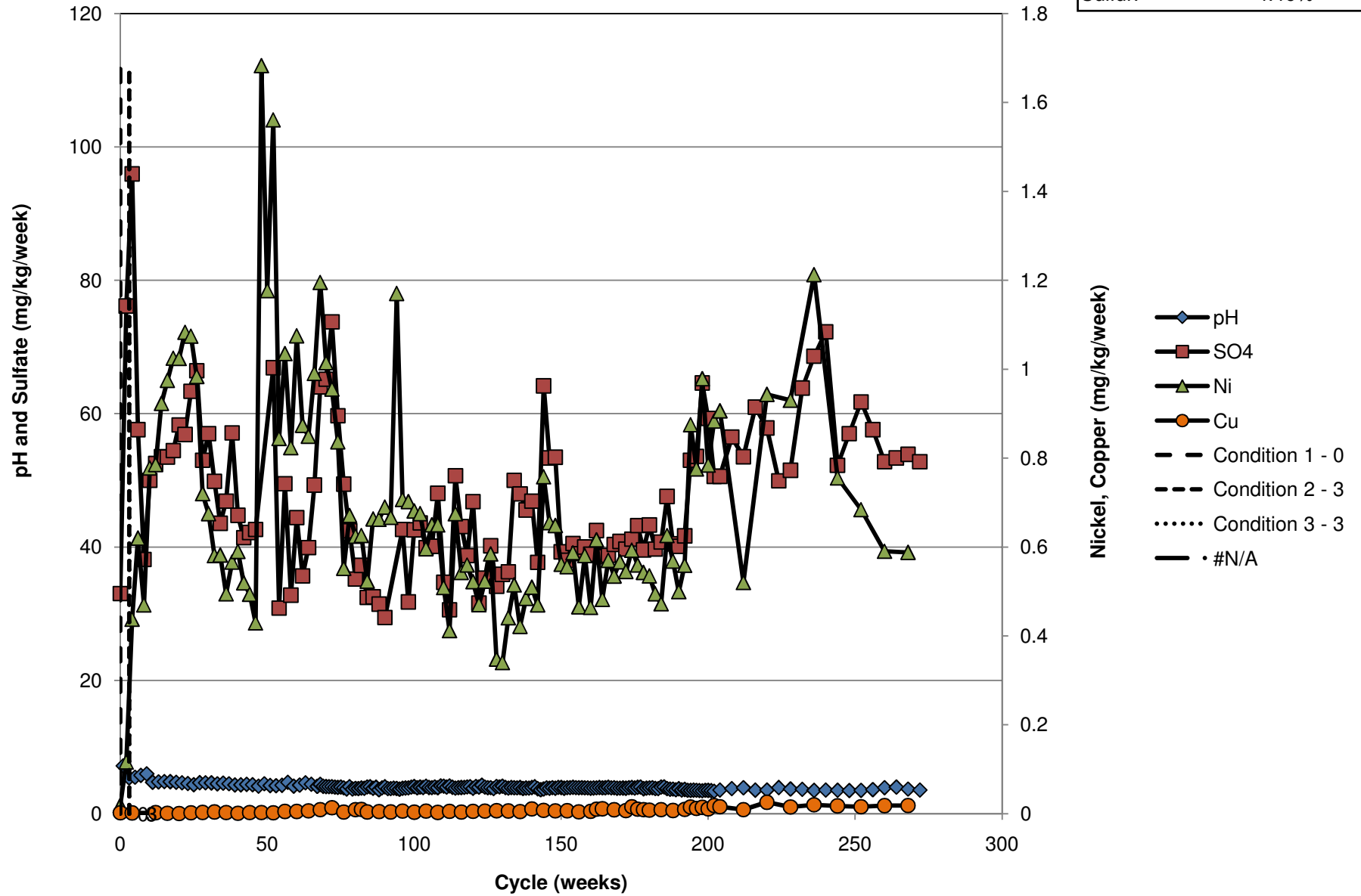

# 26058(704-715)

Waste Category:	4
Rock Type:	Sedimentary Hornfels
Geology:	Duluth Complex
Sulfur:	1.46%

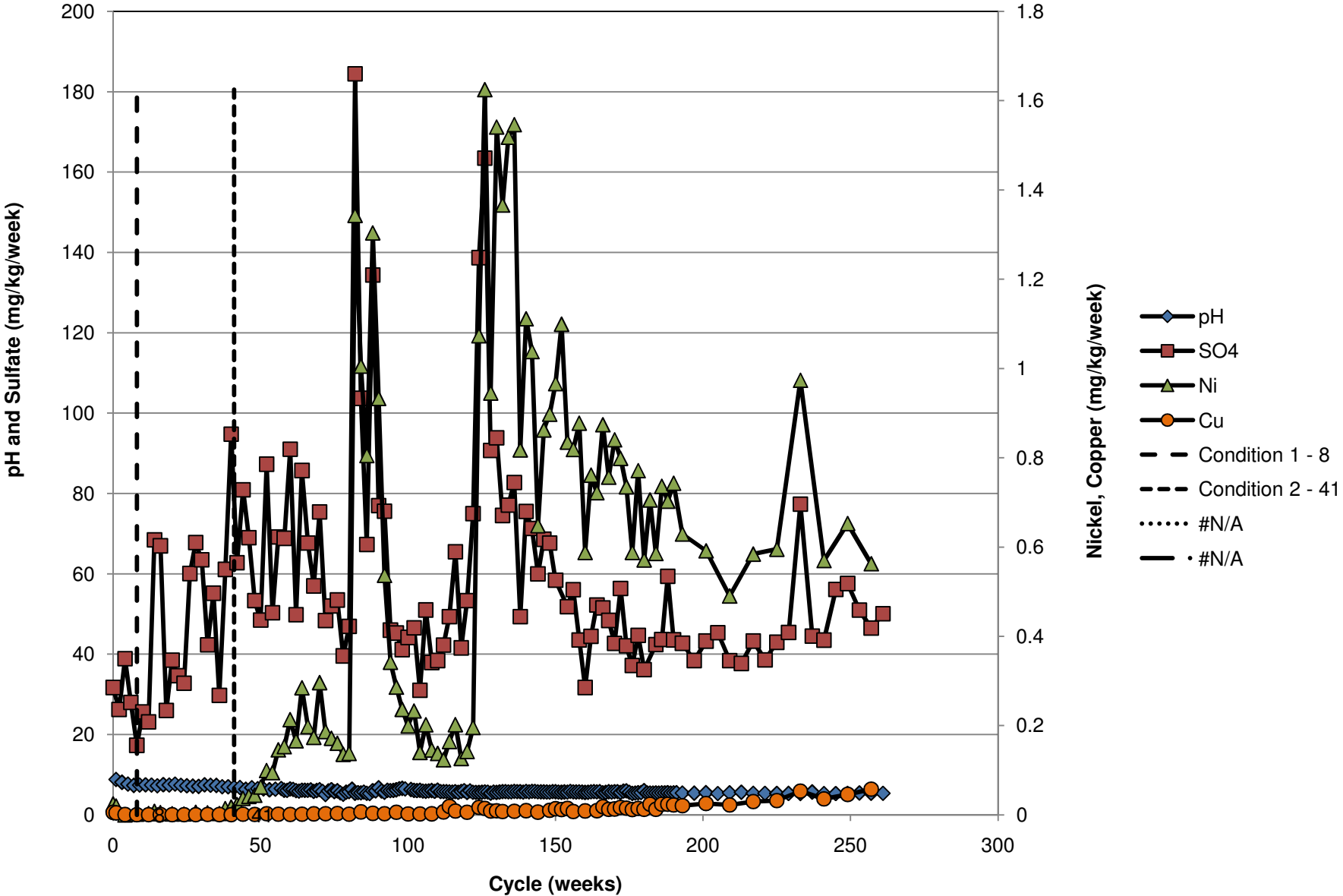



# 00-340C(965-974.5)

Waste Category:	4
Rock Type:	Sedimentary Hornfels
Geology:	Duluth Complex
Sulfur:	1.74%

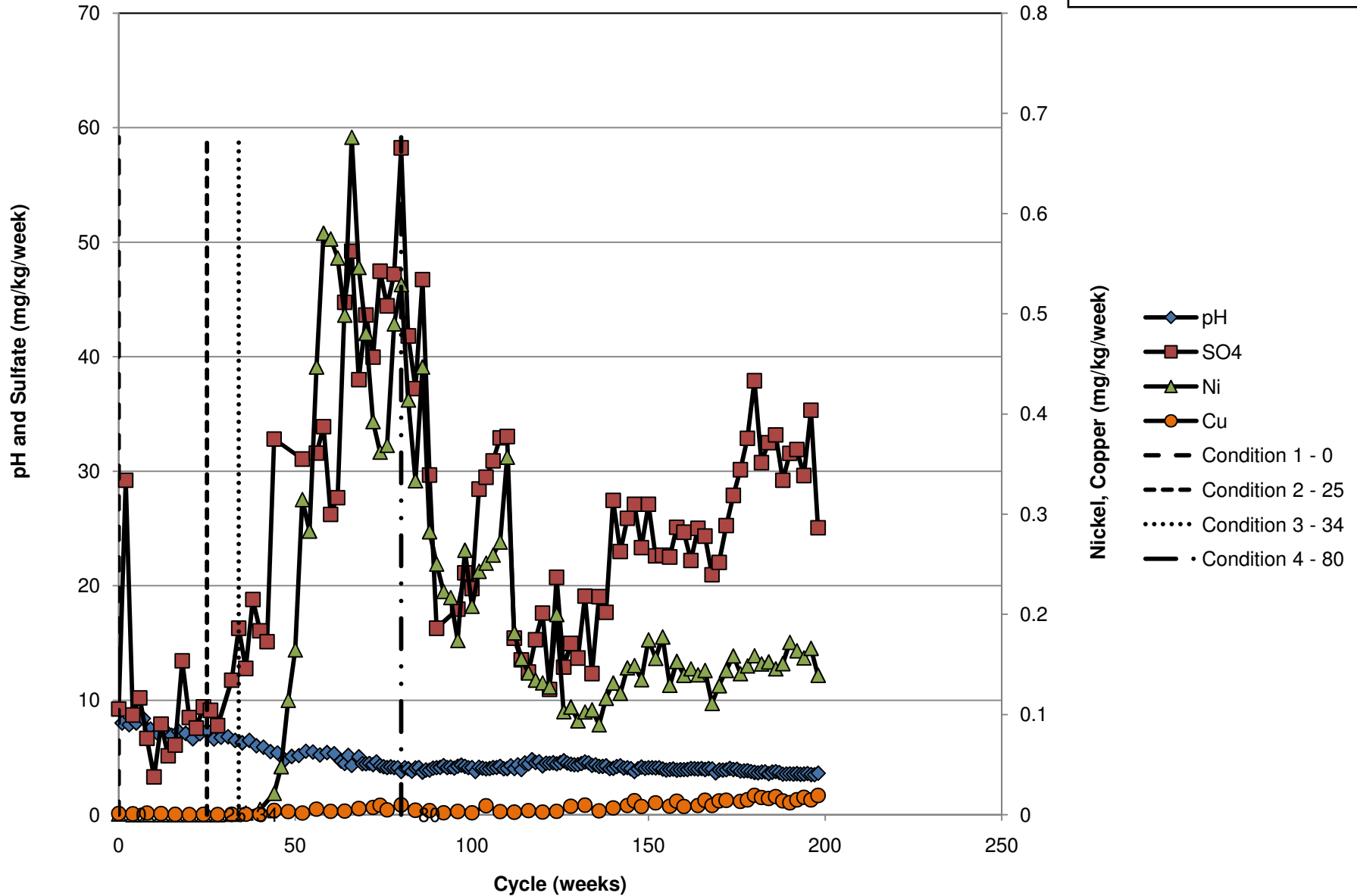

# 00-371C(435-440)

Waste Category:	4
Rock Type:	Troctolitic
Geology:	Duluth Complex
Sulfur:	0.88%

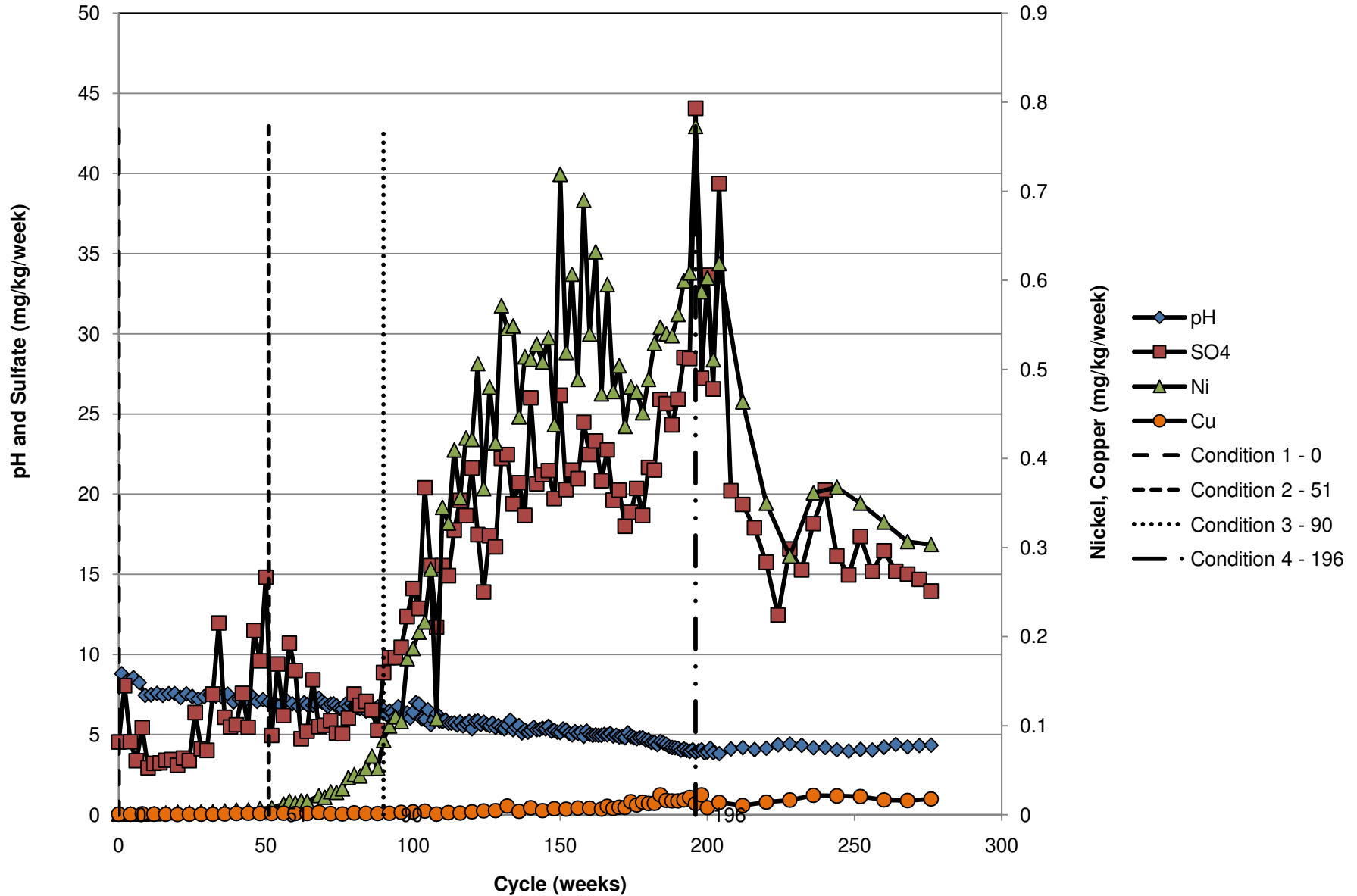

# 00-340C(765-780)

Waste Category:	4
Rock Type:	Troctolitic
Geology:	Duluth Complex
Sulfur:	1.68%

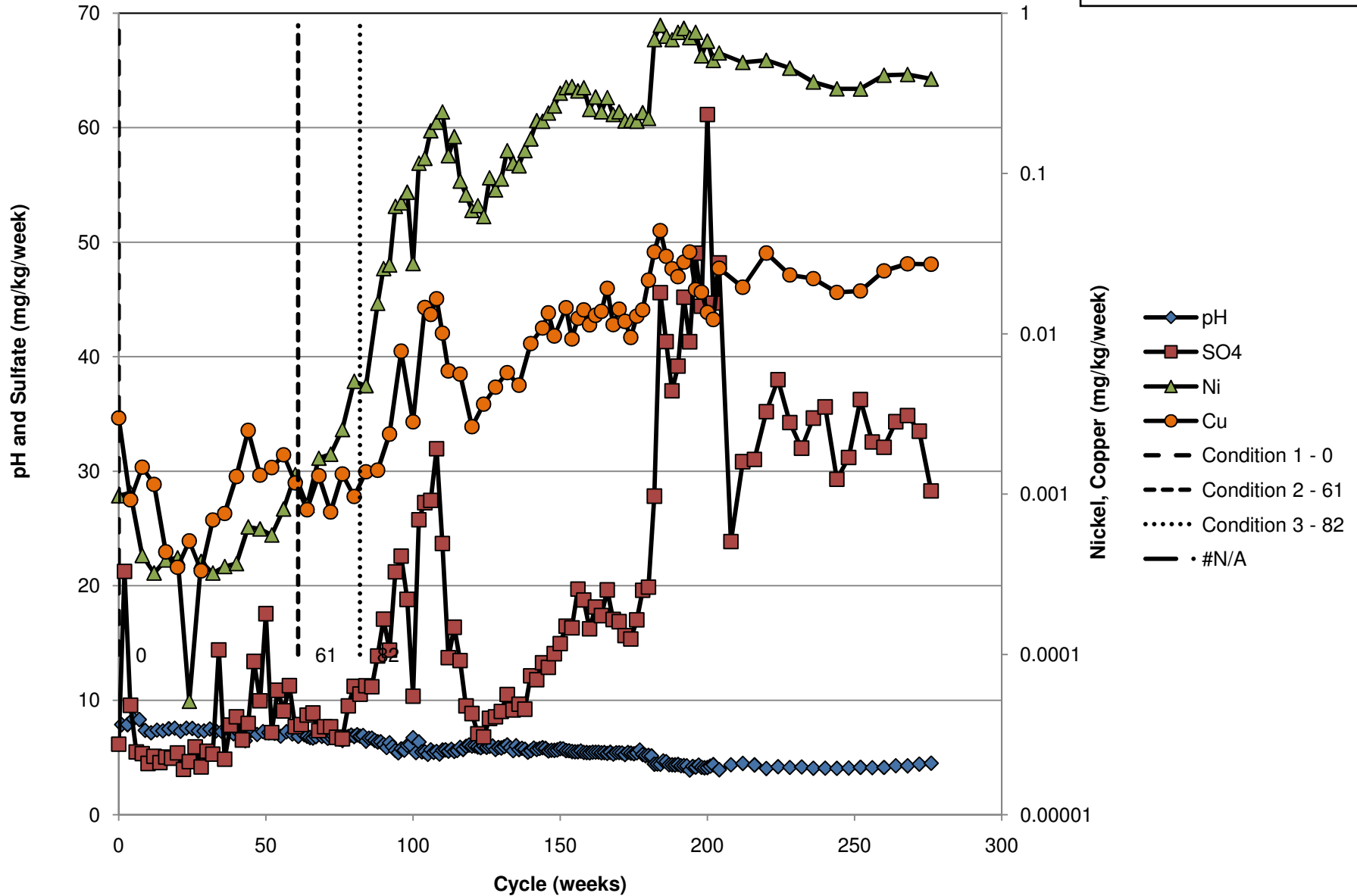

# 00-367C(395-400)

Waste Category:	4
Rock Type:	Troctolitic
Geology:	Duluth Complex
Sulfur:	0.77%

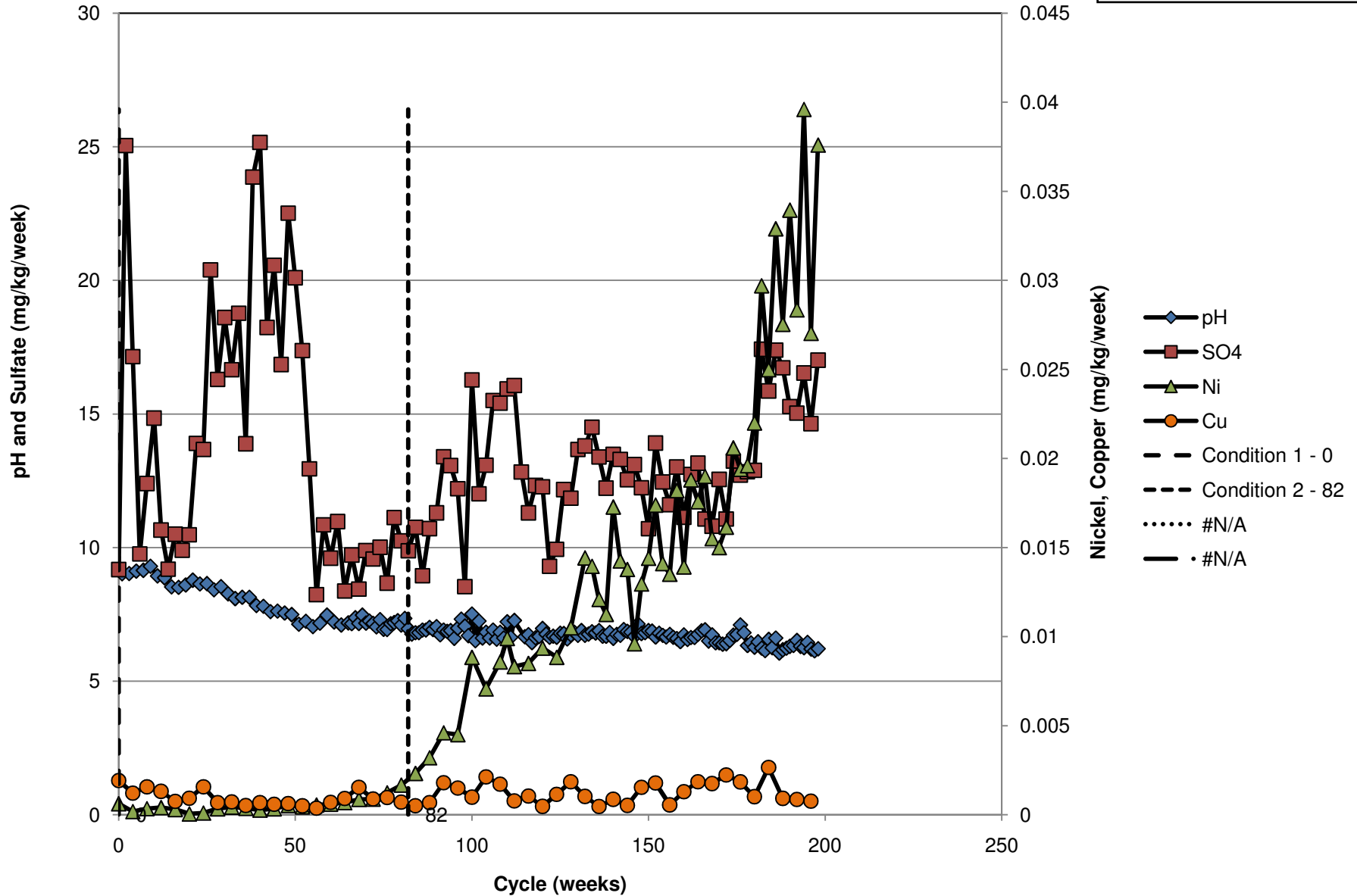

# 00-340C(725-745)

Waste Category:	4
Rock Type:	Troctolitic
Geology:	Duluth Complex
Sulfur:	0.91%

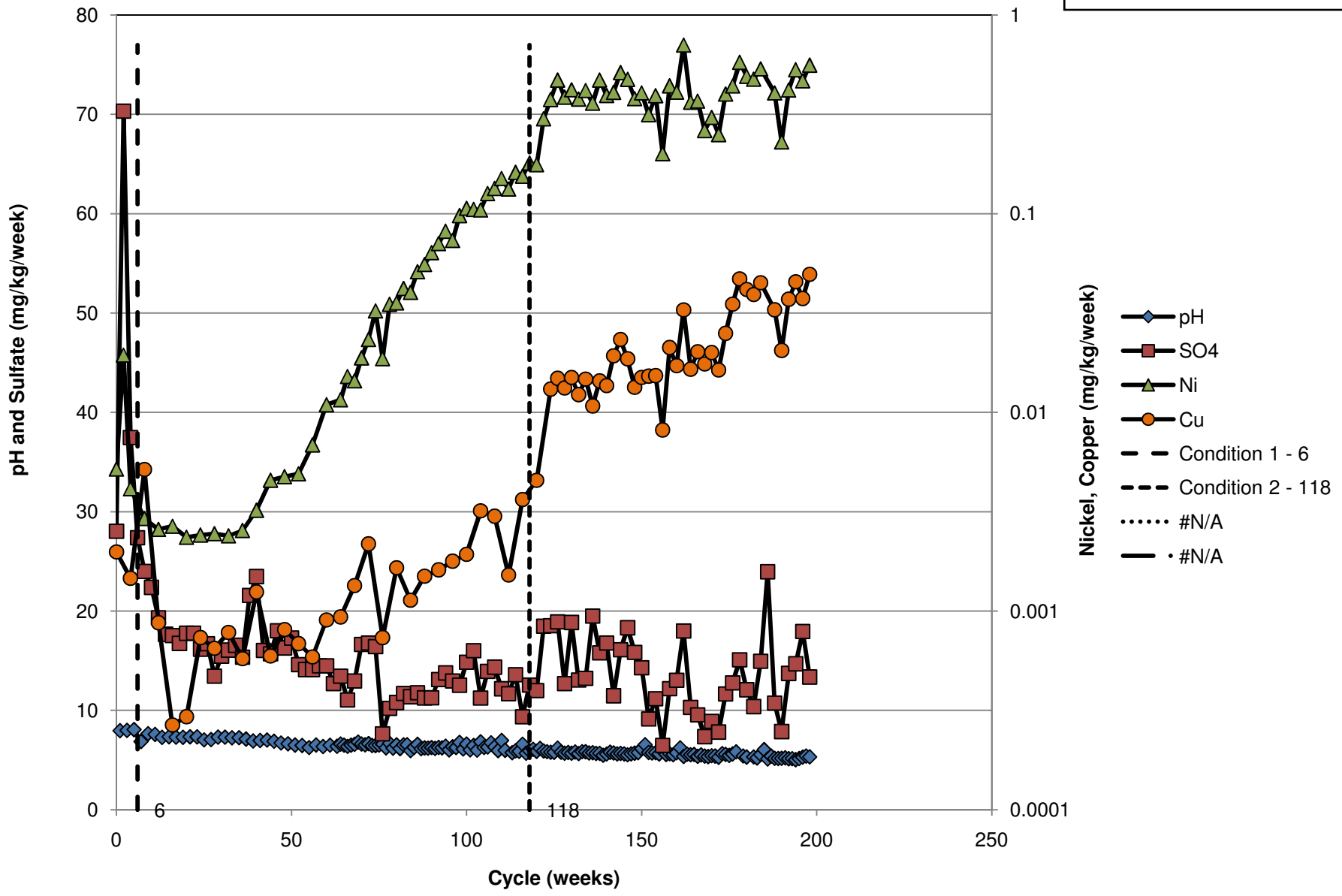

# 00-367(400-405)

Waste Category:	4
Rock Type:	Troctolitic
Geology:	Duluth Complex
Sulfur:	1.37%

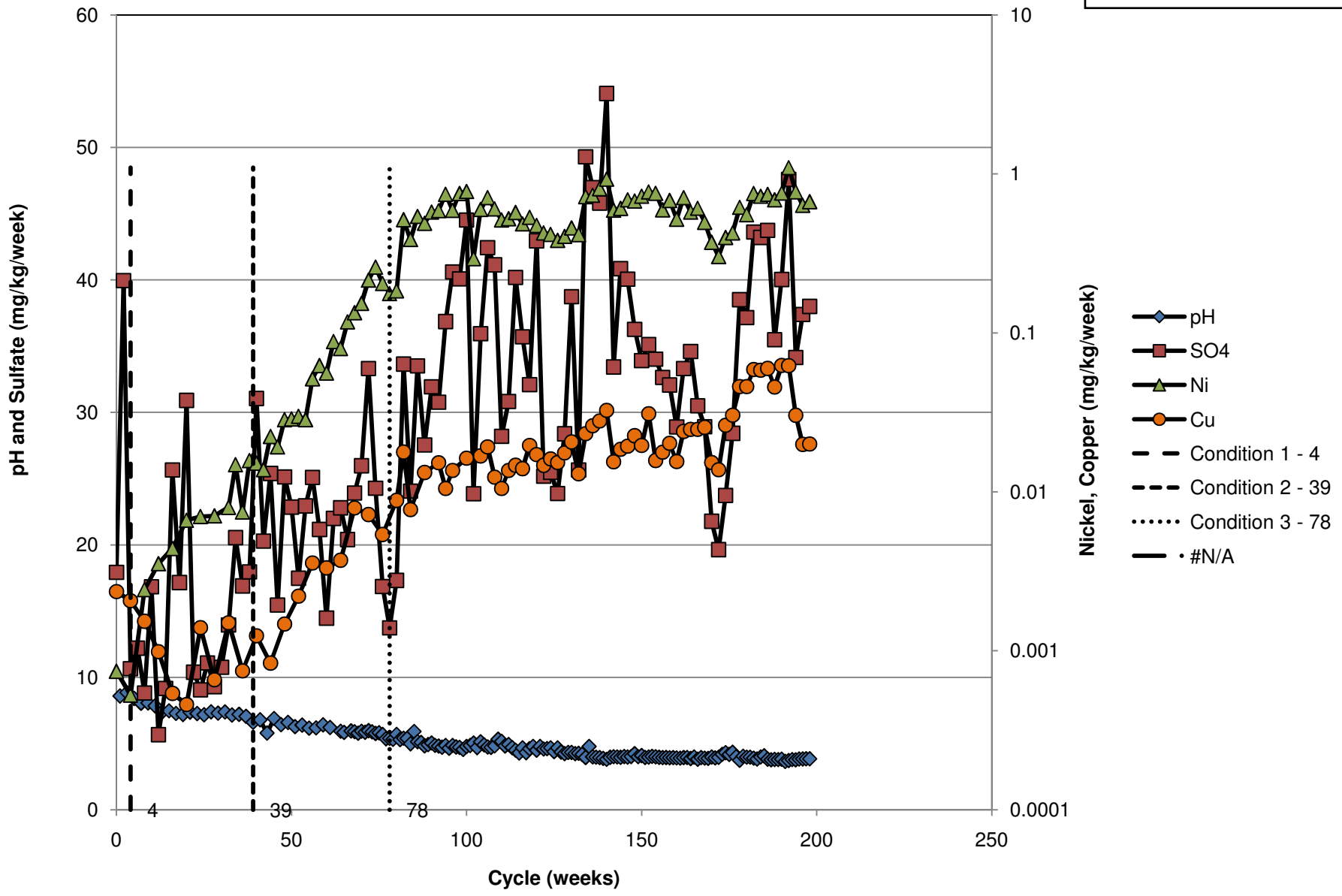

# 99-318C(725-735)

Waste Category:	4
Rock Type:	Ultramafic
Geology:	Duluth Complex
Sulfur:	0.72%

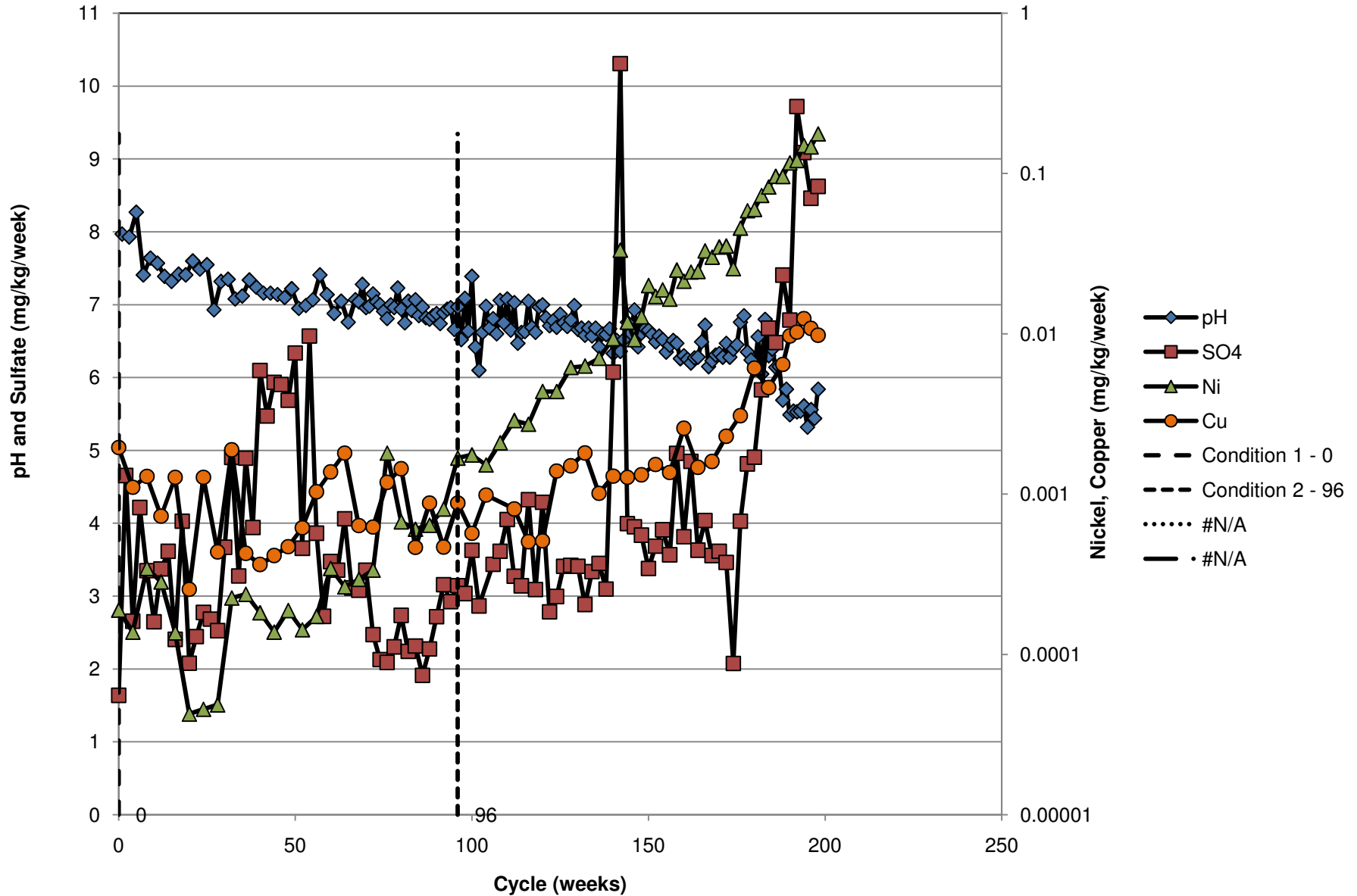

# 99-317C(460-470)

Waste Category:	4
Rock Type:	Ultramafic
Geology:	Duluth Complex
Sulfur:	1.24%

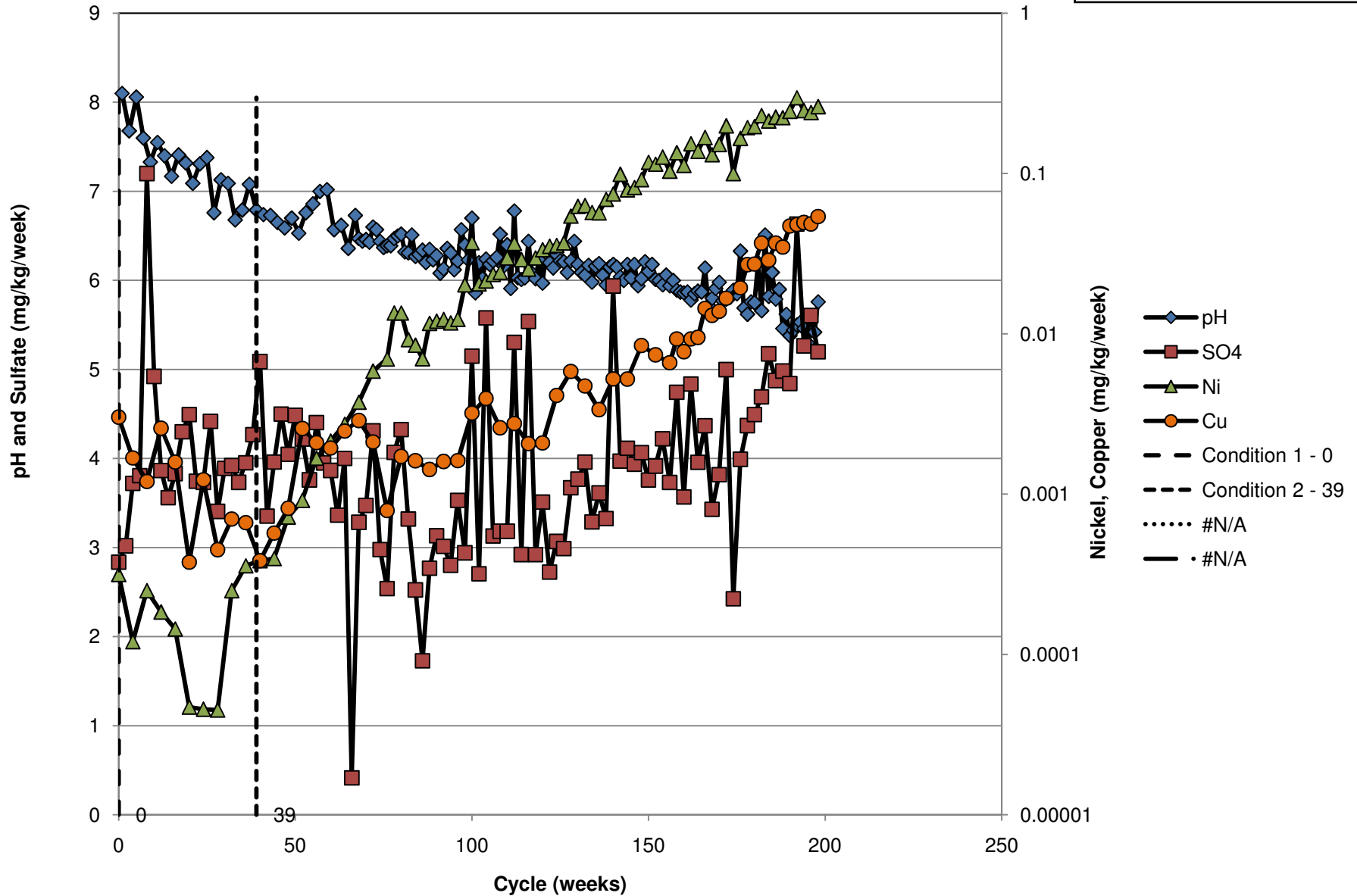



# 00-344C(515-520)

Waste Category:	4
Rock Type:	Ultramafic
Geology:	Duluth Complex
Sulfur:	1.20%

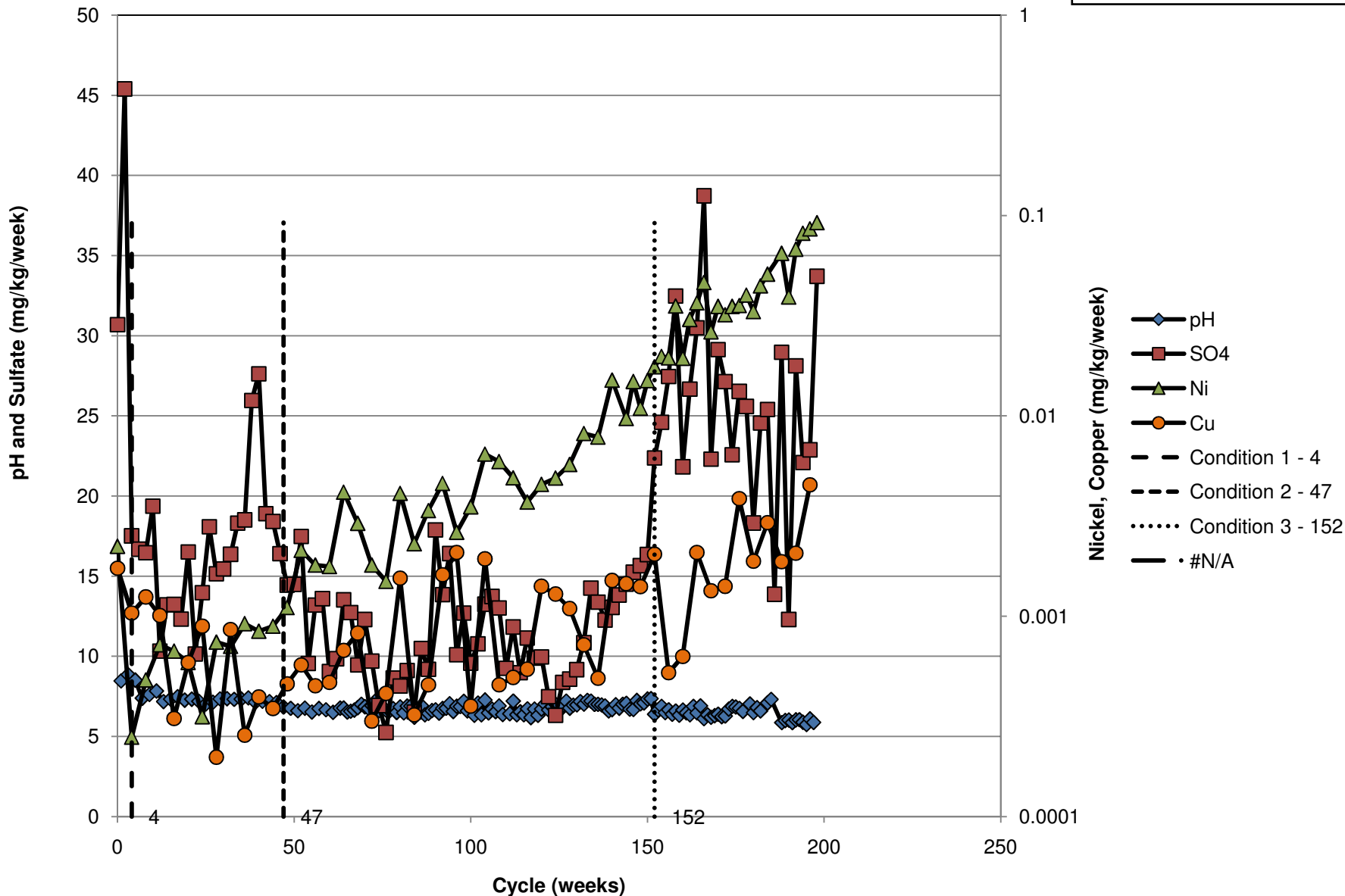

# 00-330C(275-280)

Waste Category:	4
Rock Type:	Ultramafic
Geology:	Duluth Complex
Sulfur:	0.75%

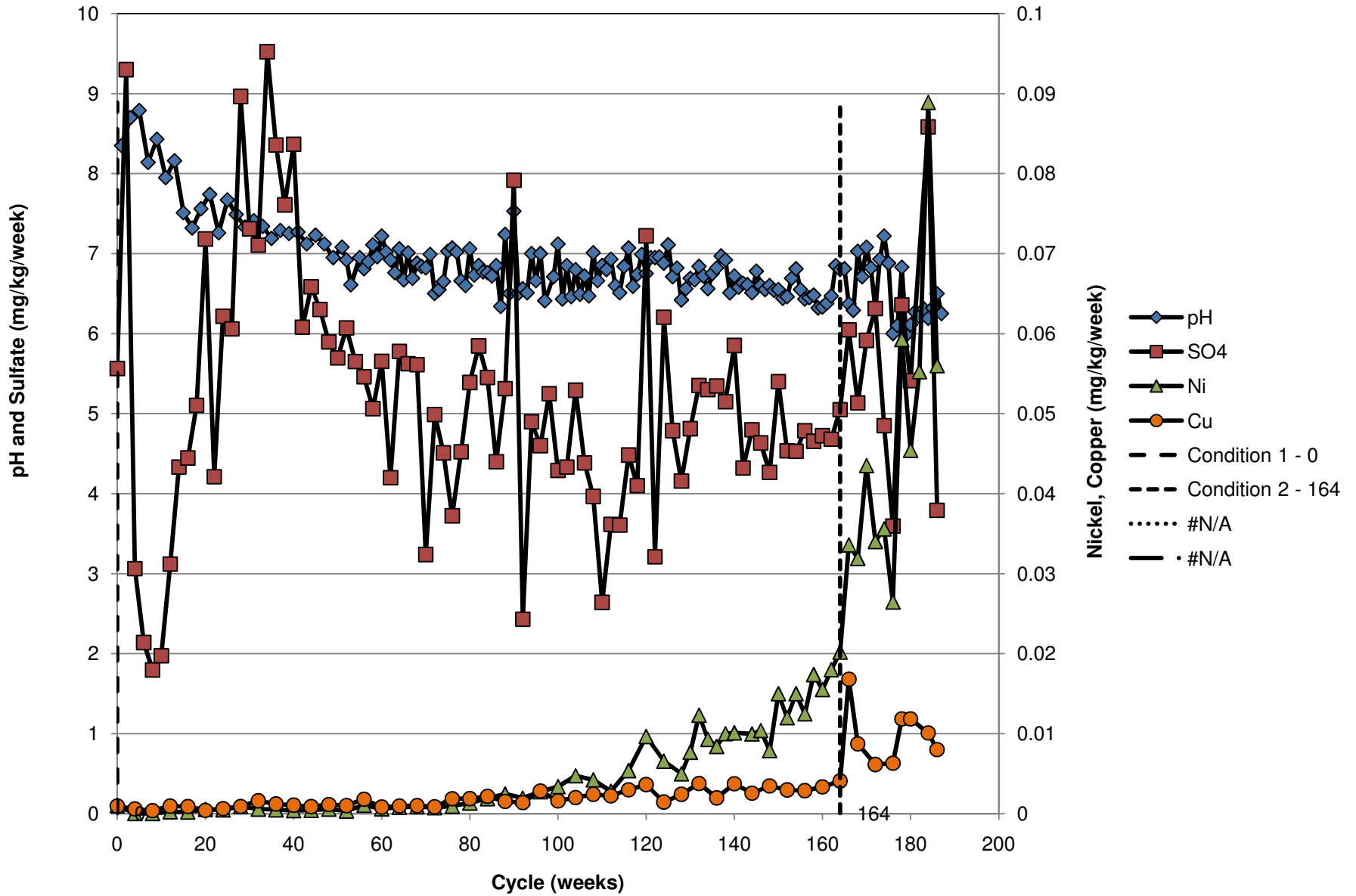

**d. Category 4 (Virginia Formation)**

# 00-361C(737-749)

Waste Category:	4
Rock Type:	Virginia
Geology:	Virginia Formation
Sulfur:	2.00%

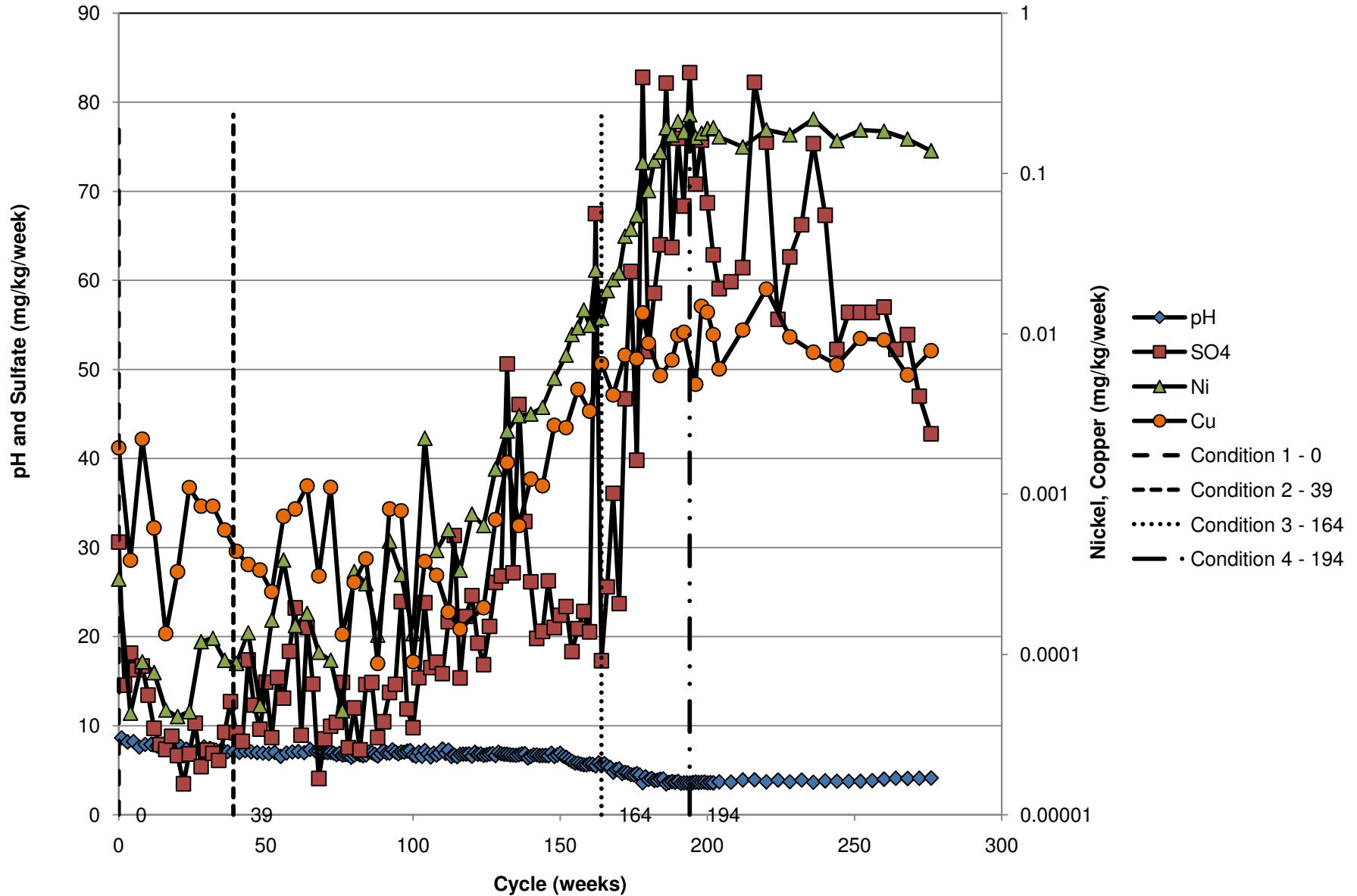

# 00-364C(210-229)

Waste Category:	4
Rock Type:	Virginia
Geology:	Virginia Formation
Sulfur:	3.79%

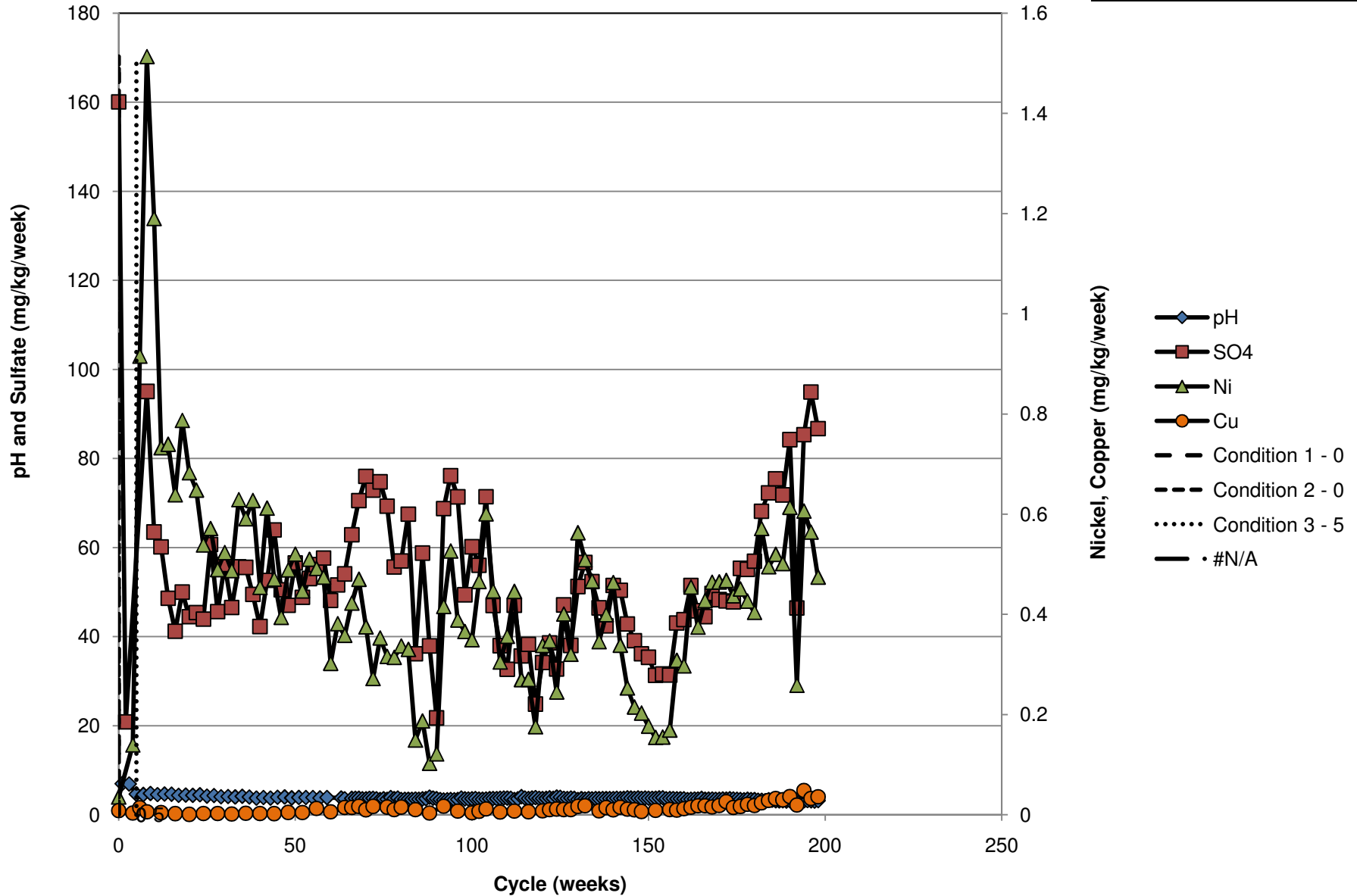

# 00-337C(510-520)

Waste Category:	4
Rock Type:	Virginia
Geology:	Virginia Formation
Sulfur:	5.68%

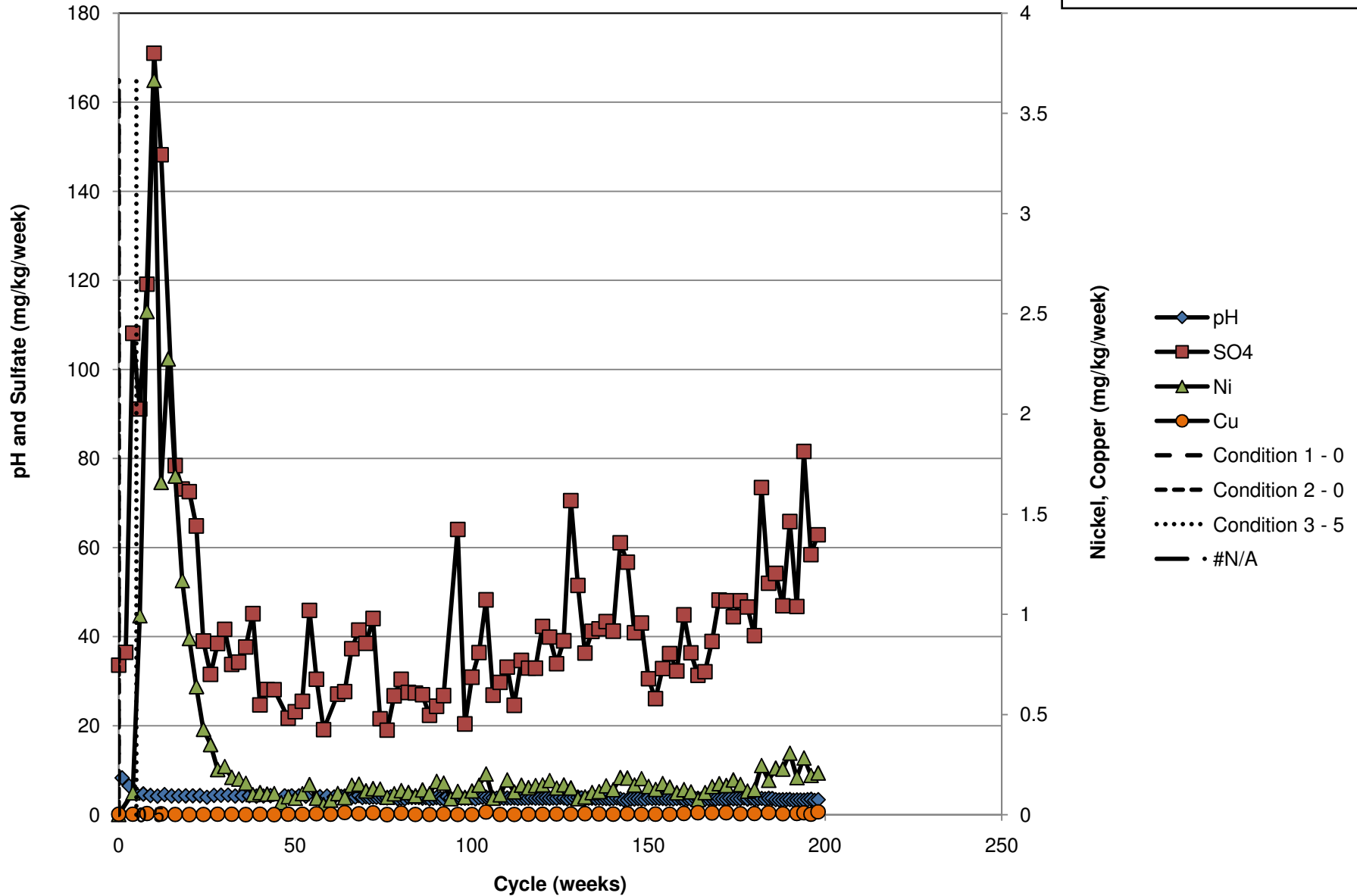

**e. Ore Composites**

# P10

Waste Category:	Ore
Rock Type:	Ore Composite
Geology:	Duluth Complex
Sulfur:	0.86%

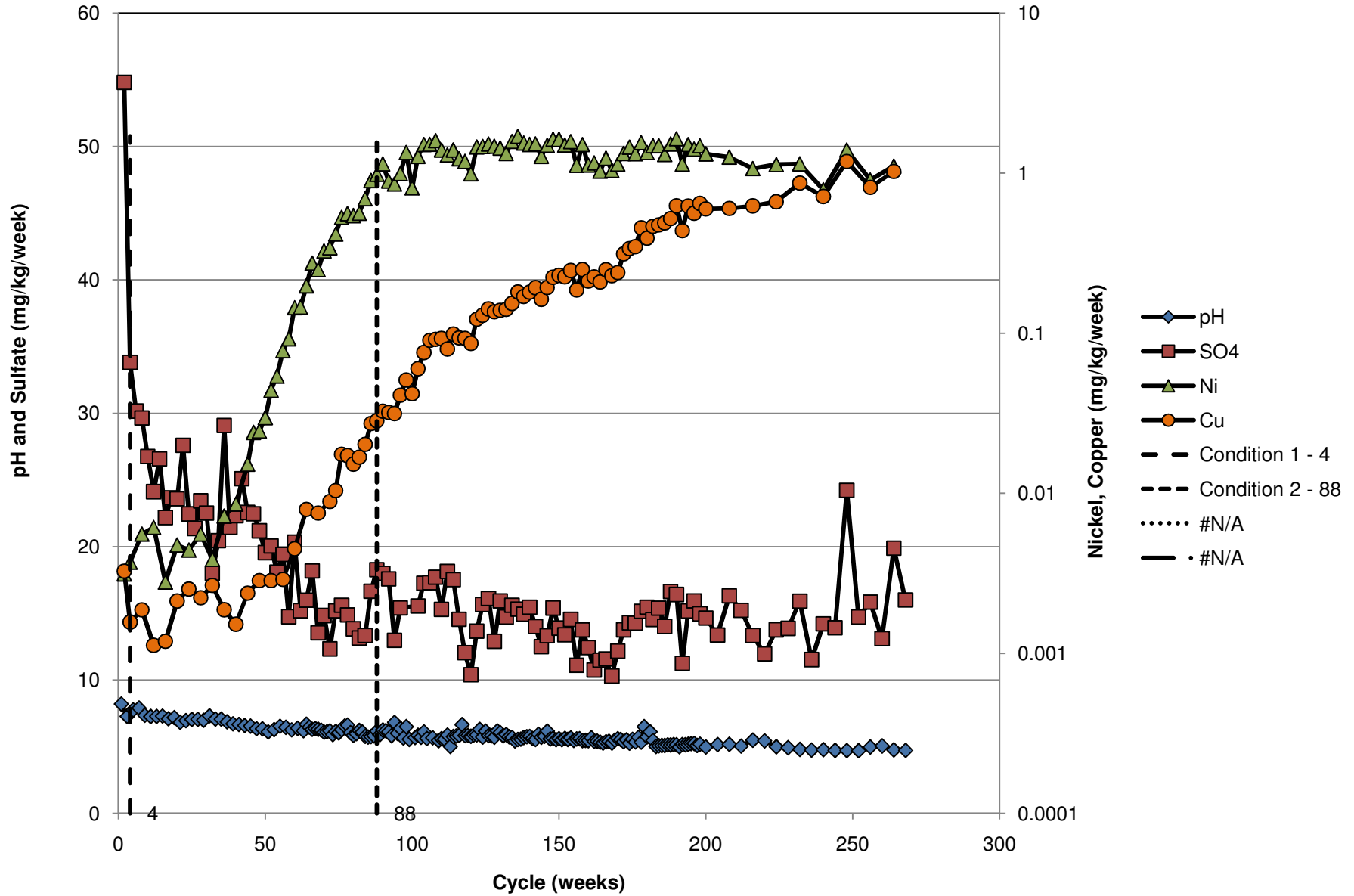



# P20

Waste Category: Ore  
Rock Type: Ore Composite  
Geology: Duluth Complex  
Sulfur: 0.90%

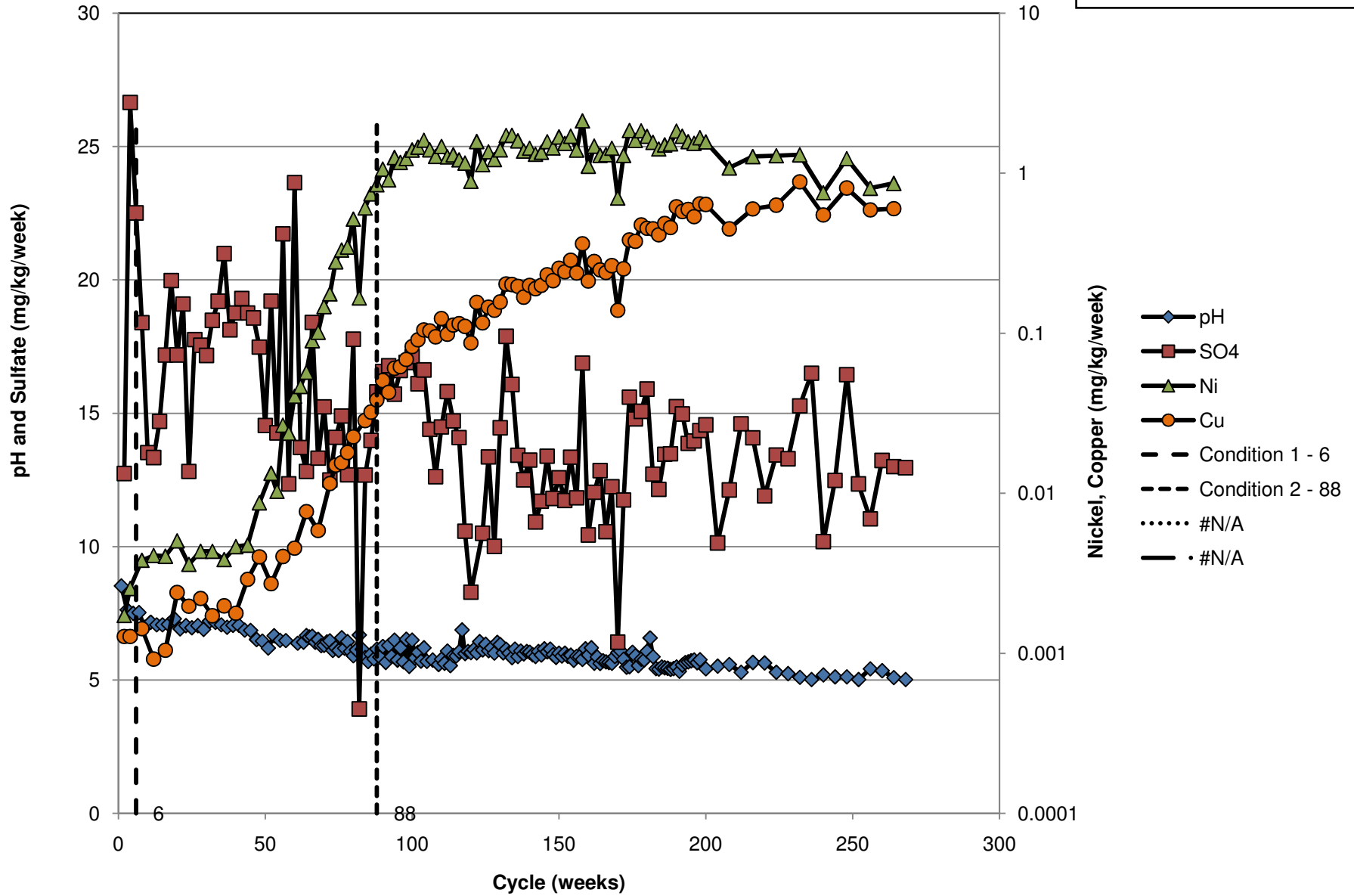

# P30

Waste Category: Ore  
Rock Type: Ore Composite  
Geology: Duluth Complex  
Sulfur: 0.86%

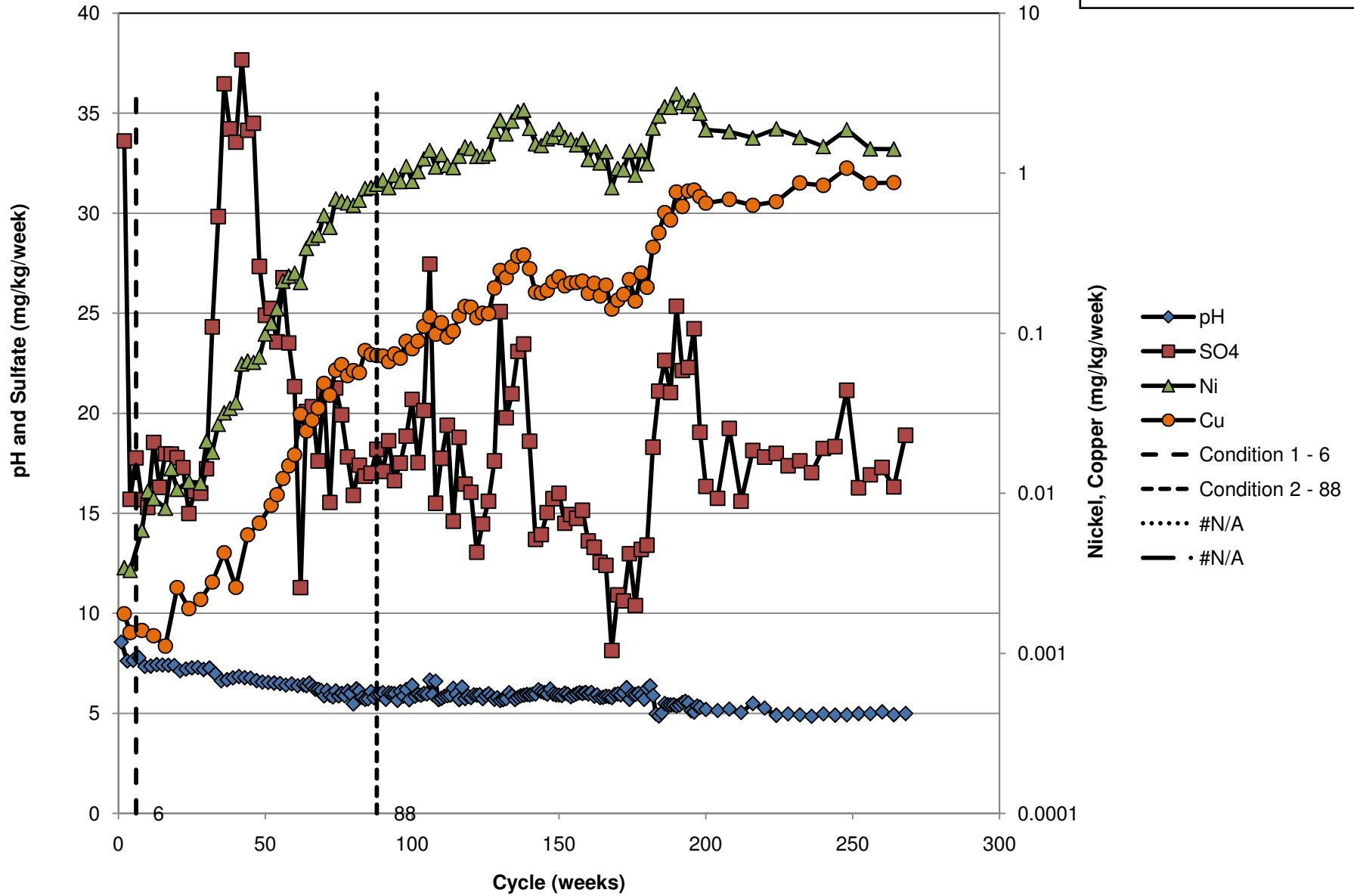



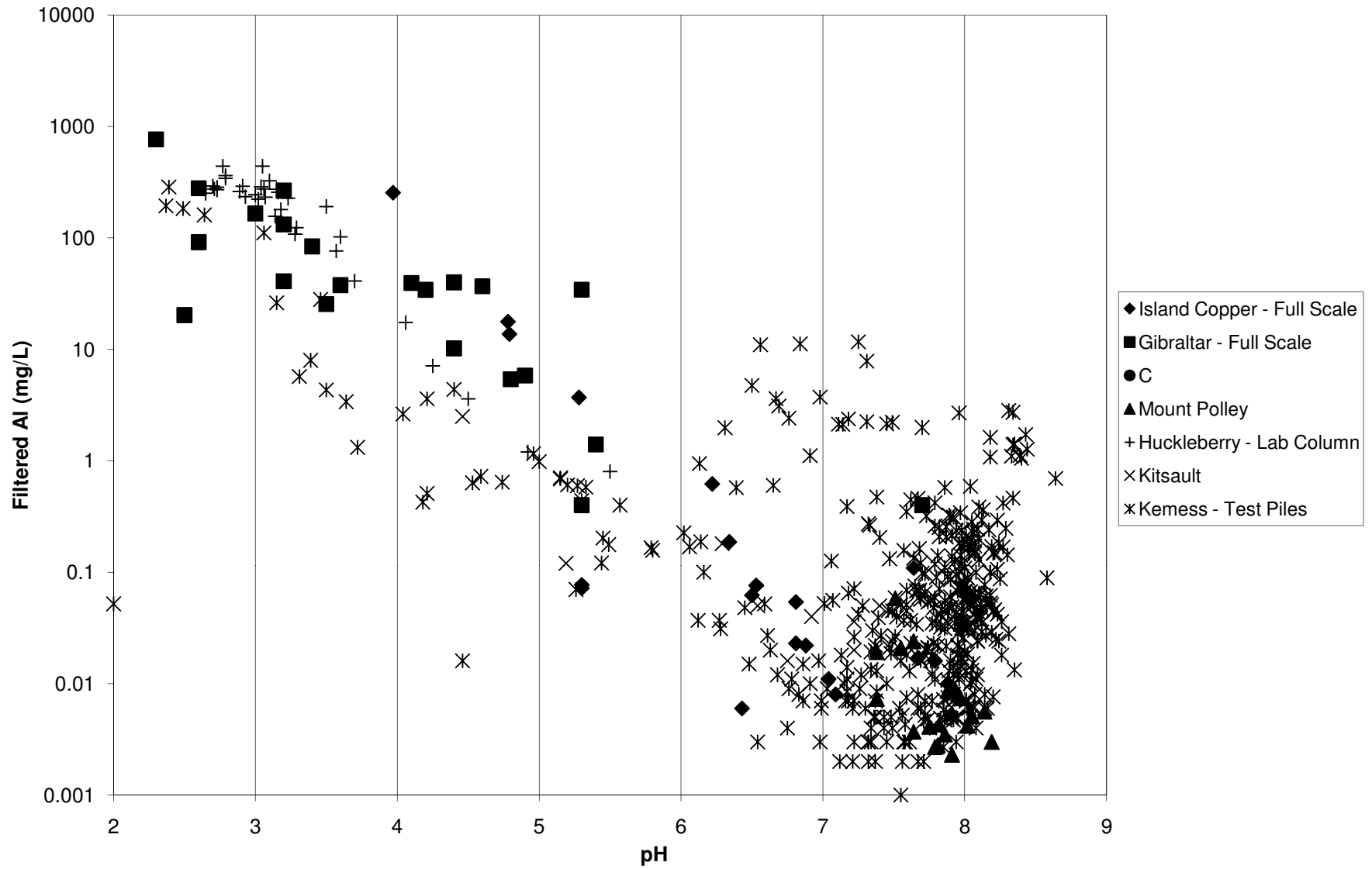

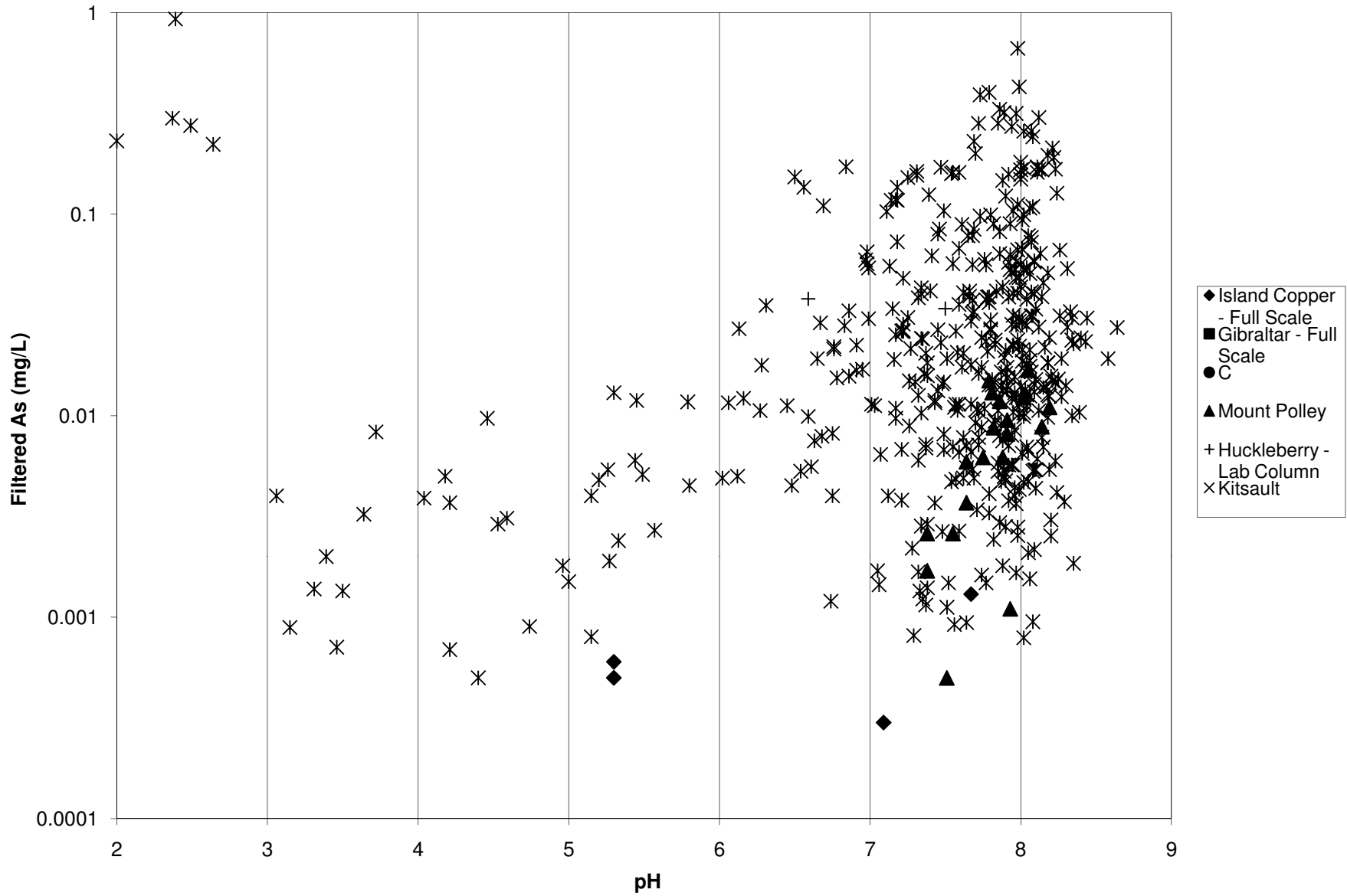

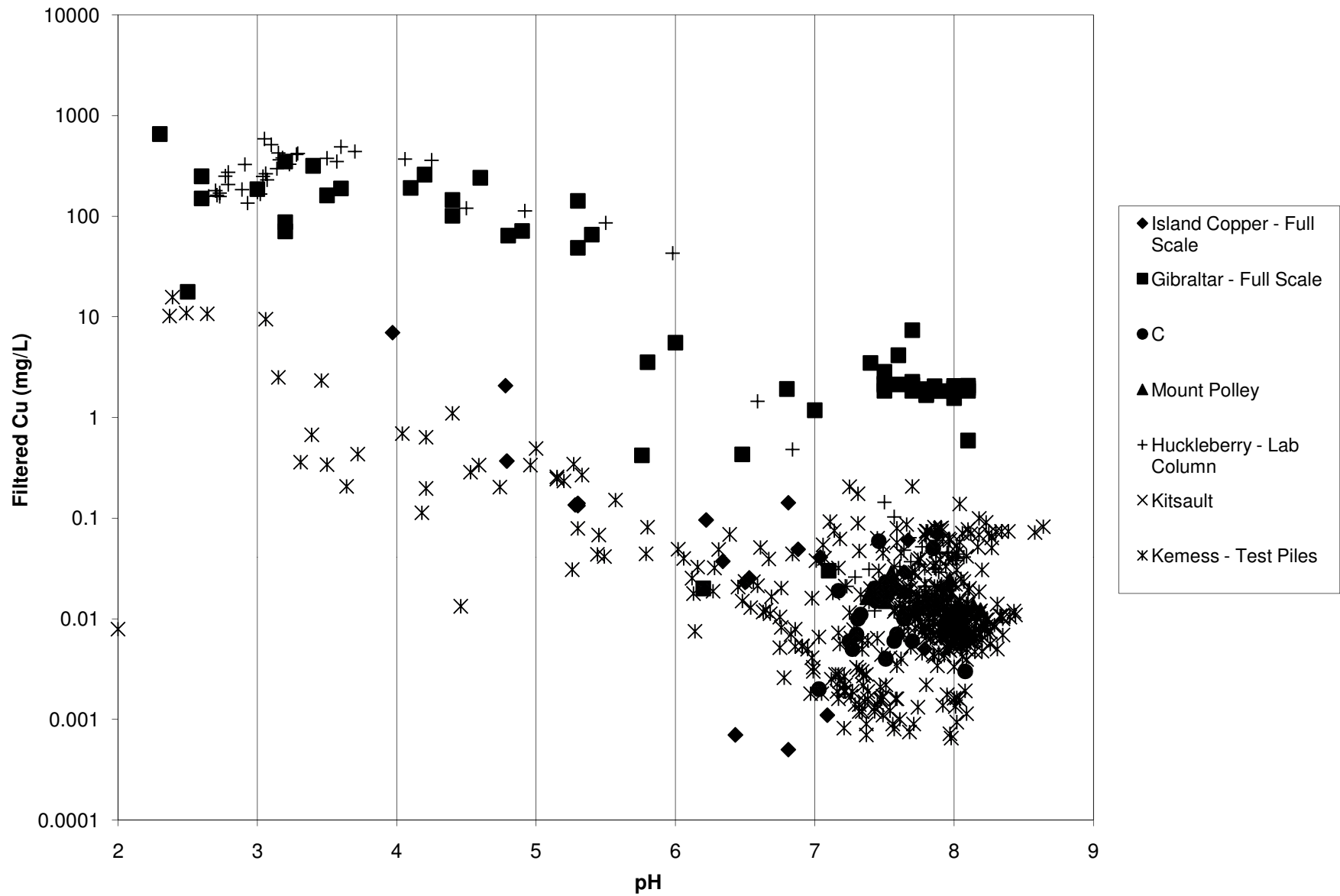

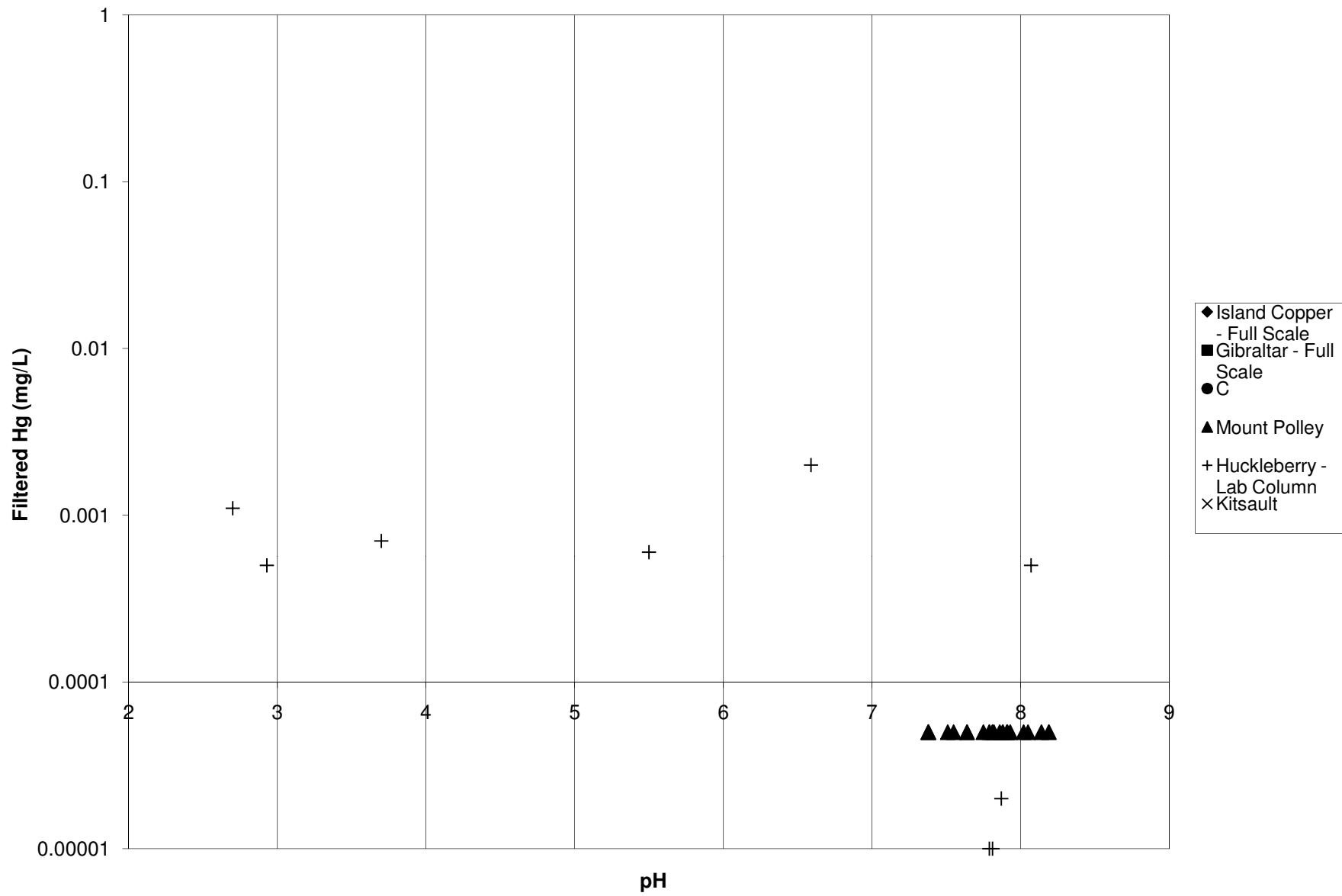

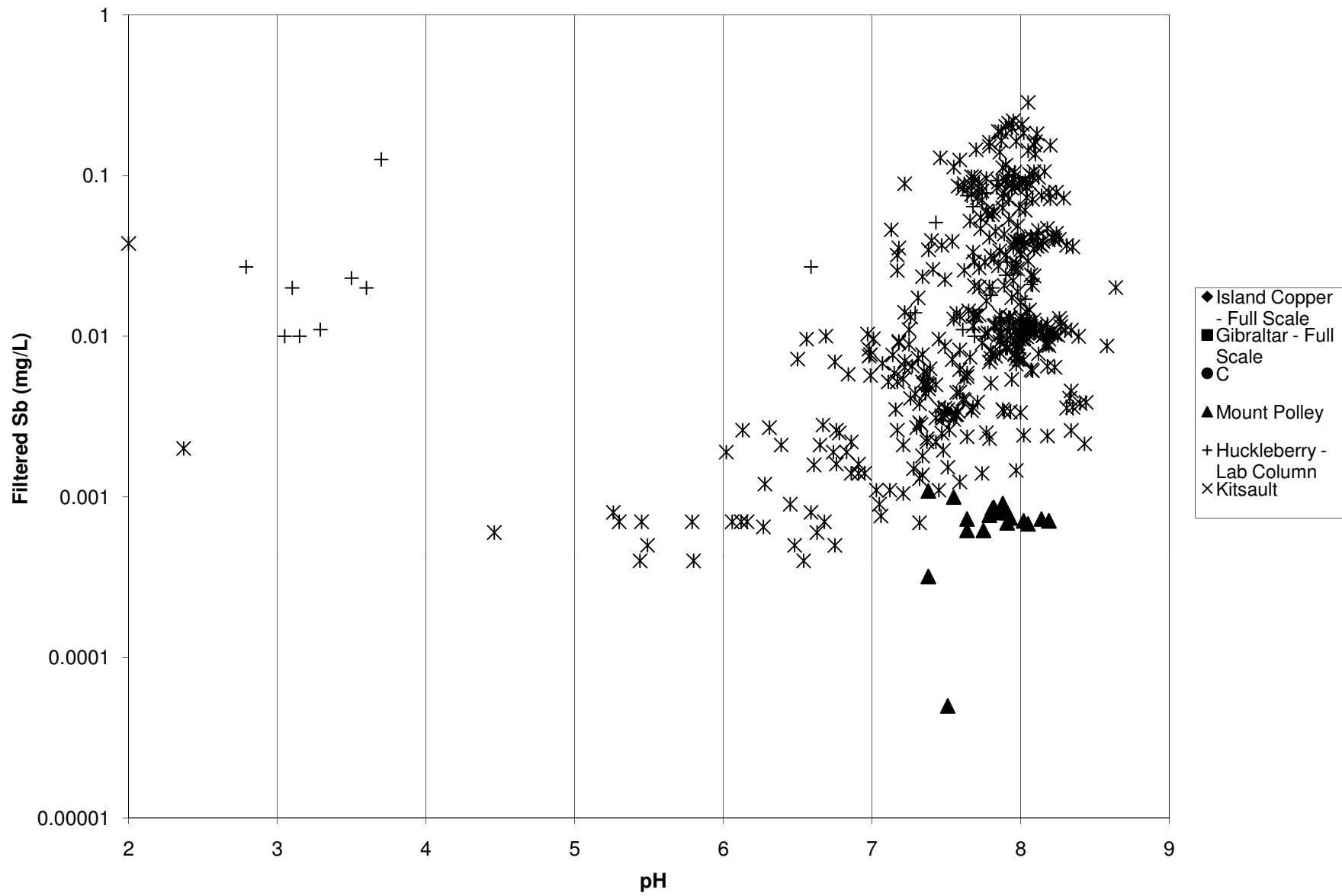



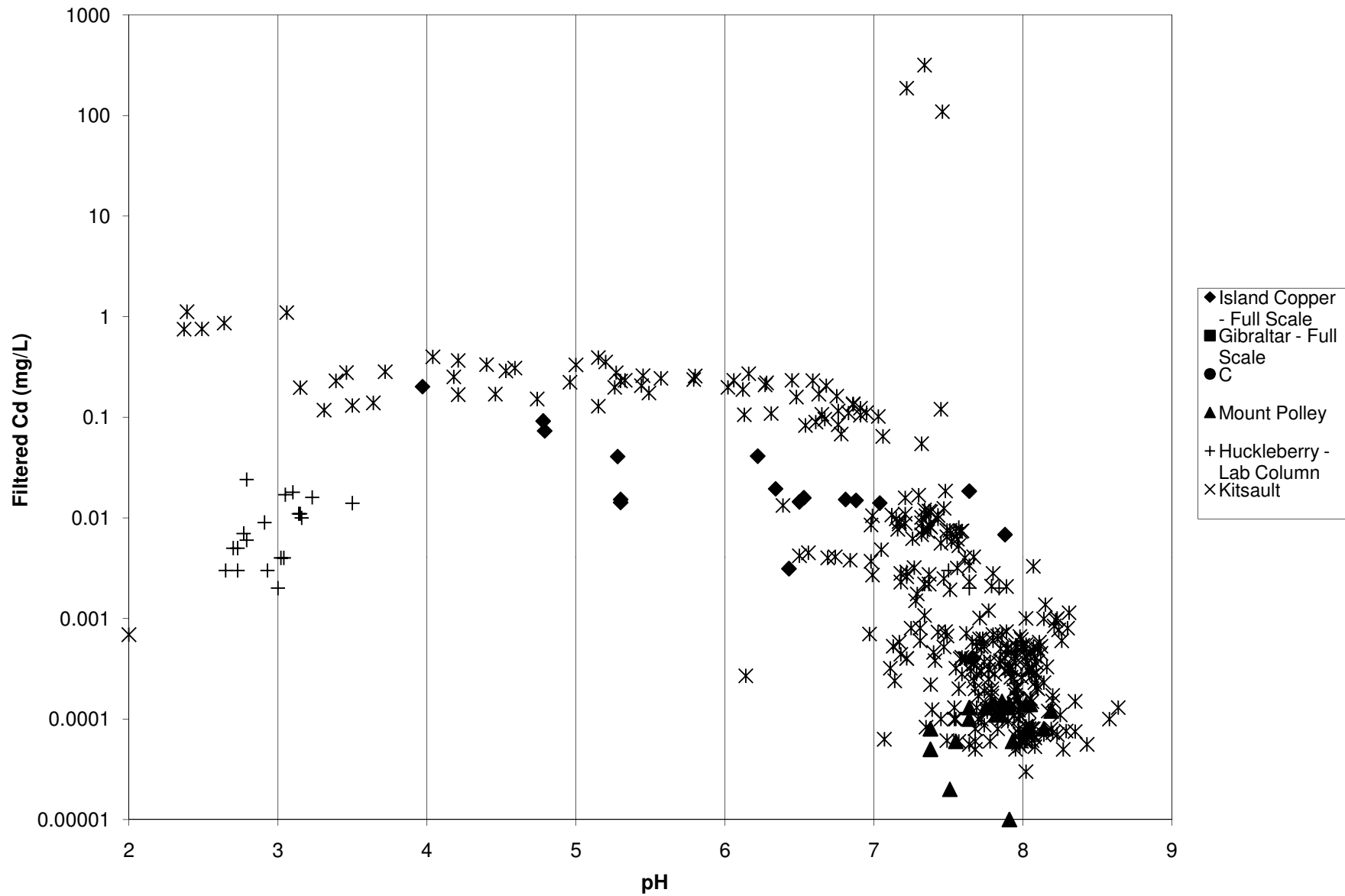

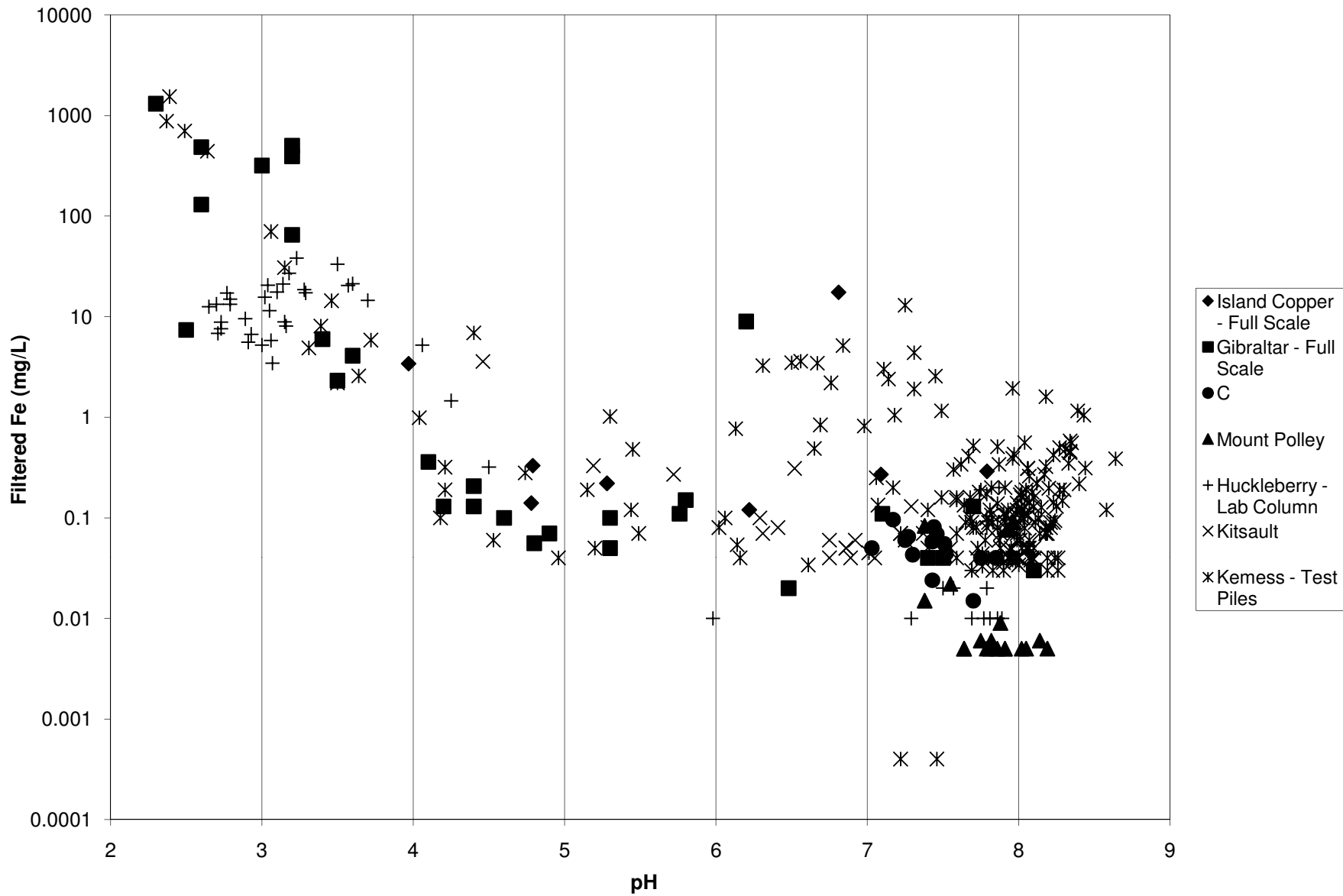

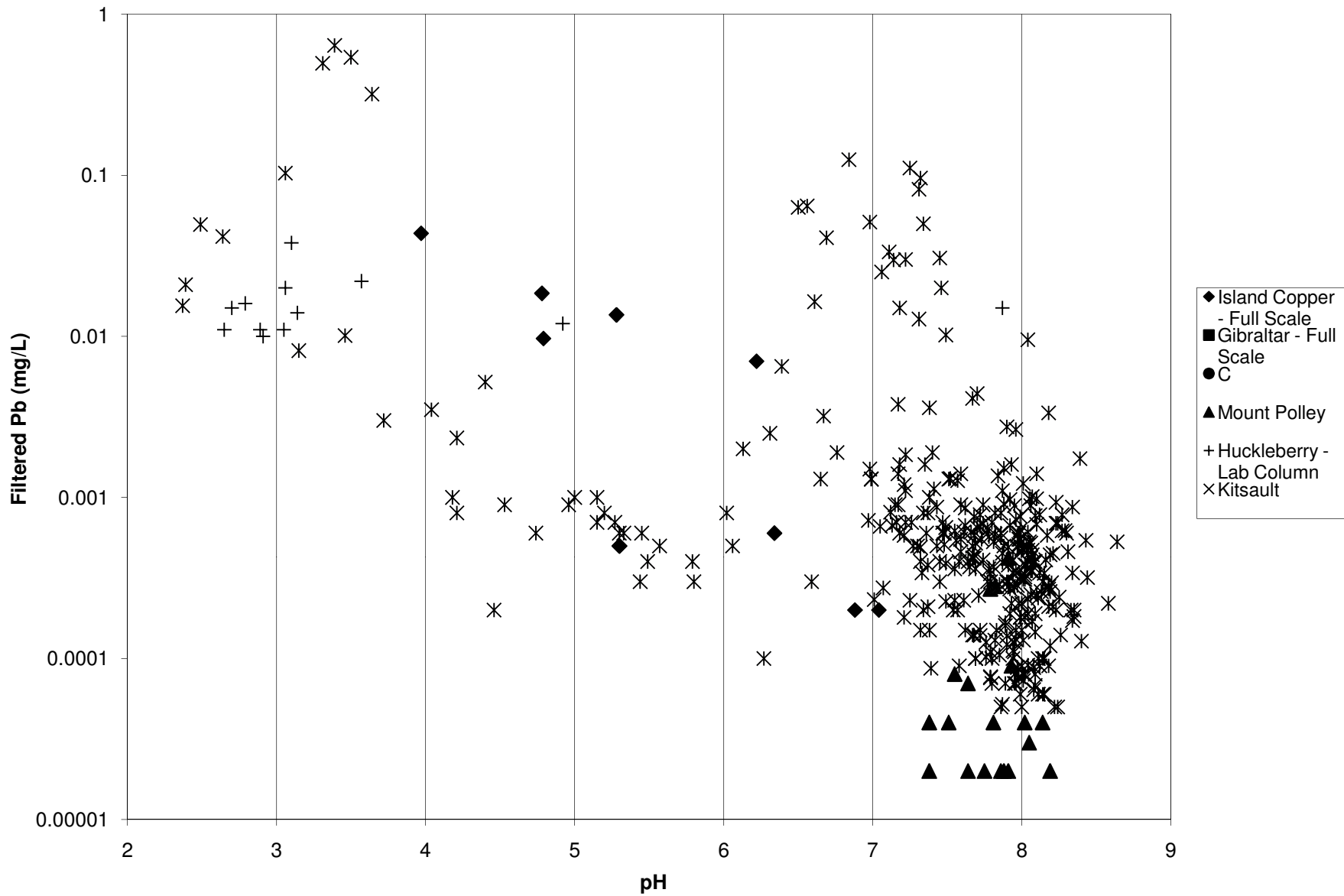

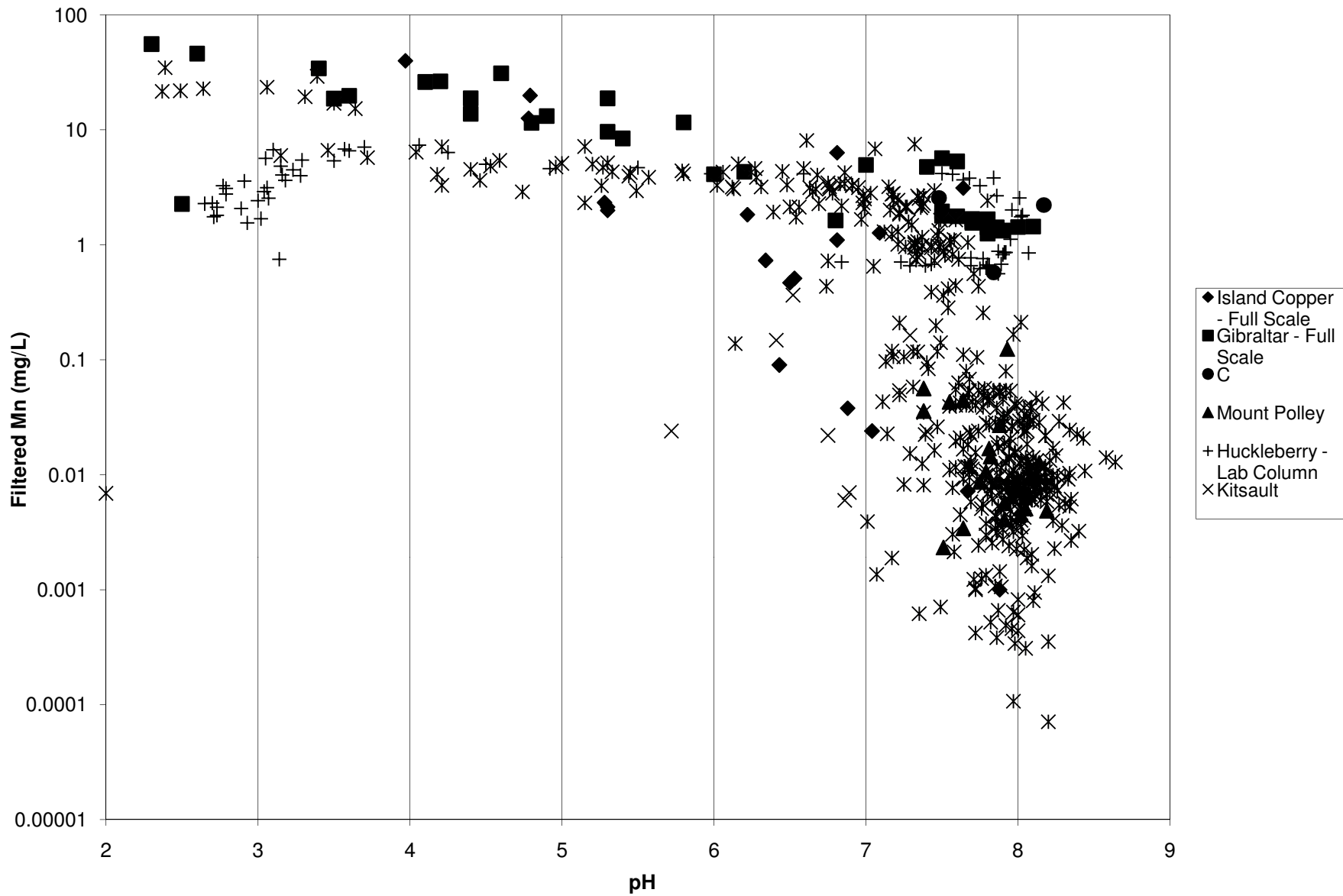

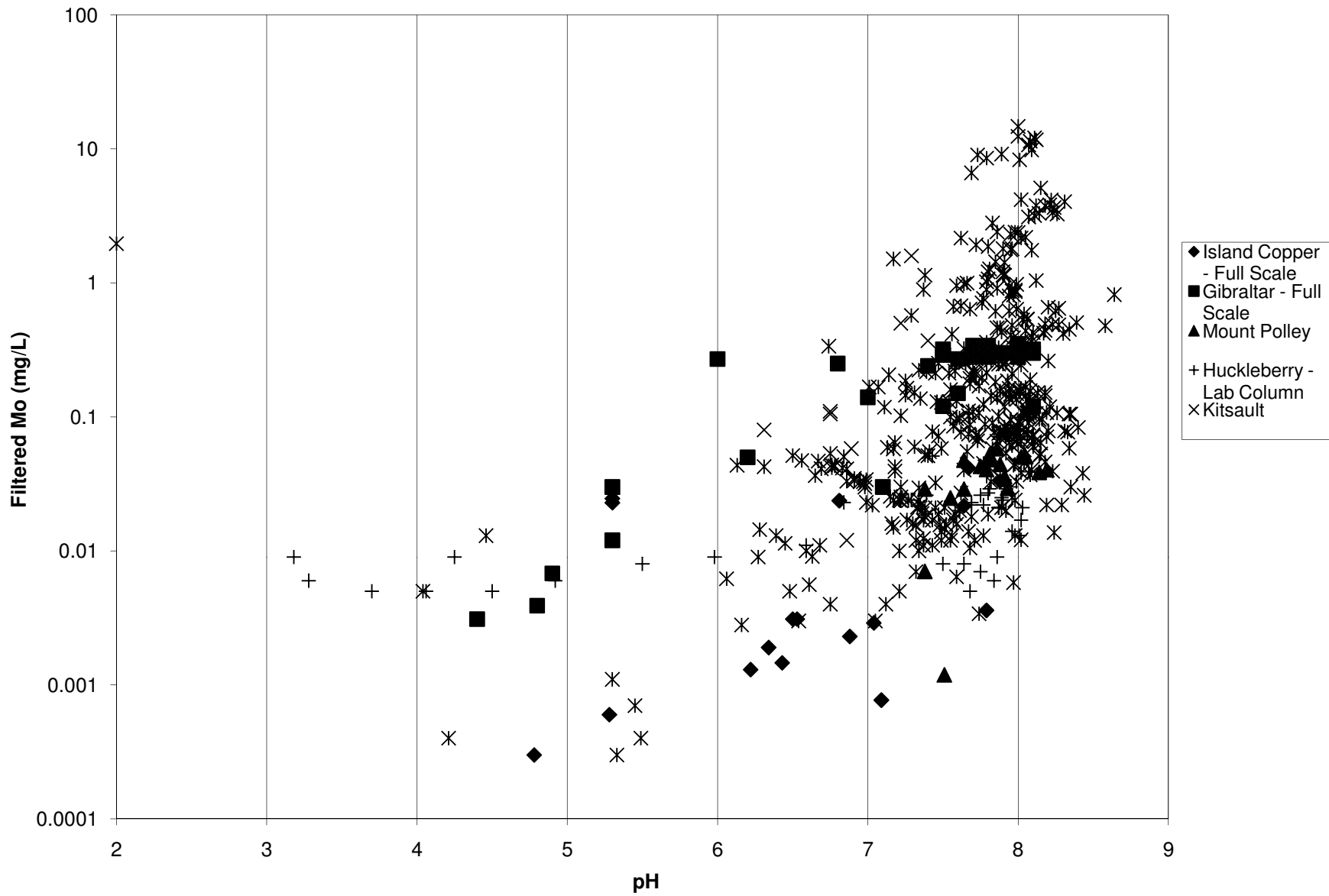

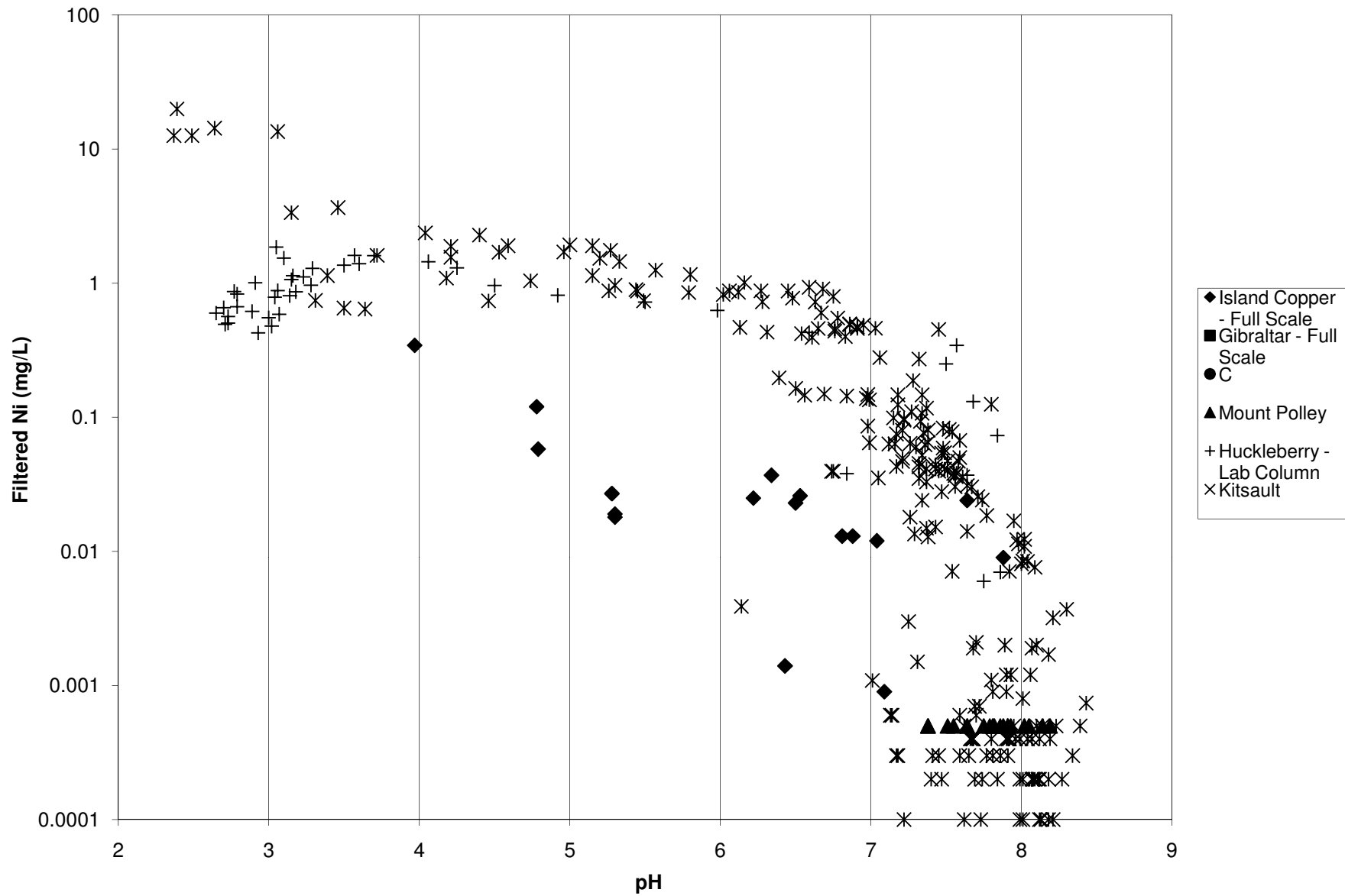

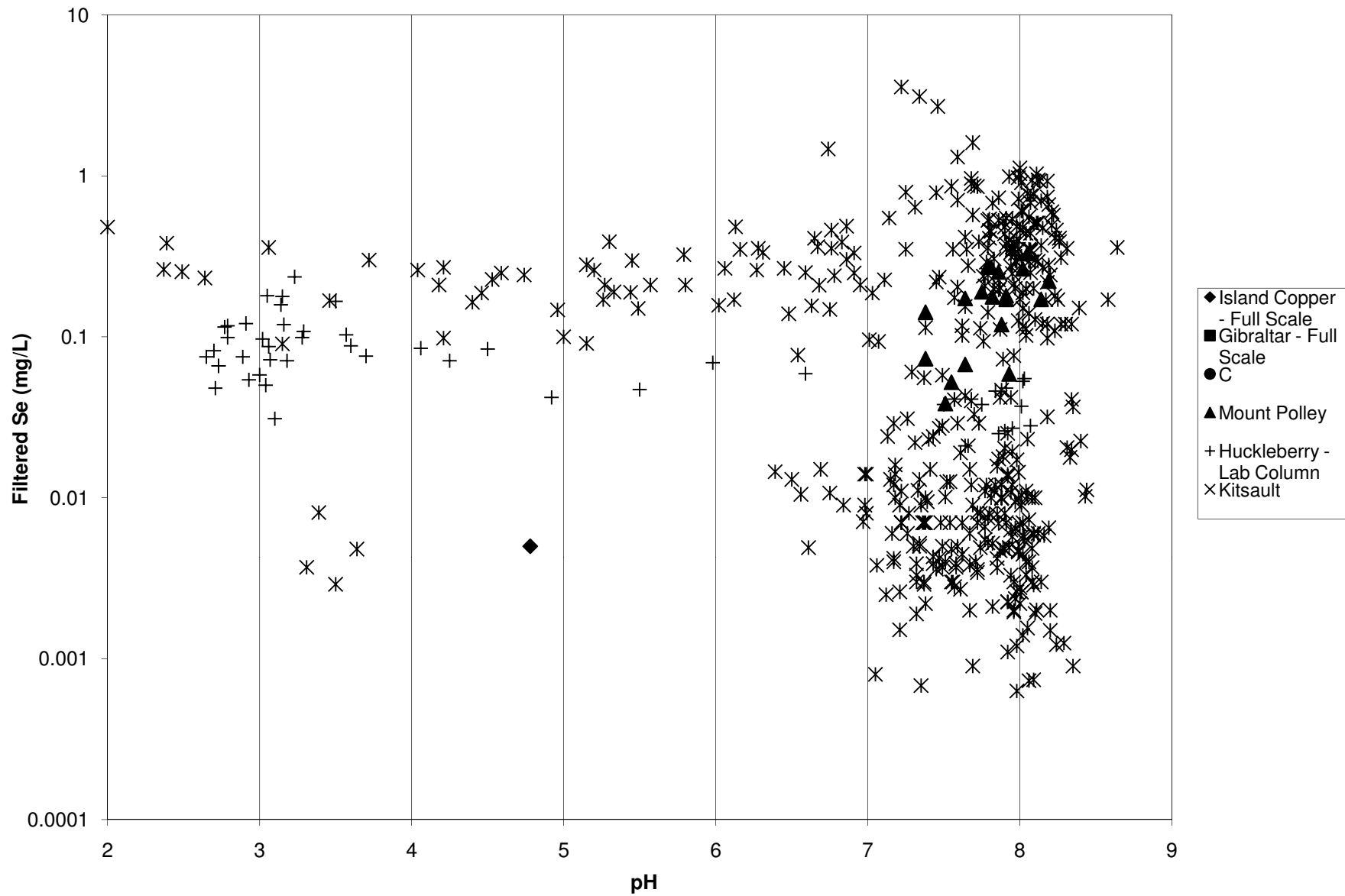

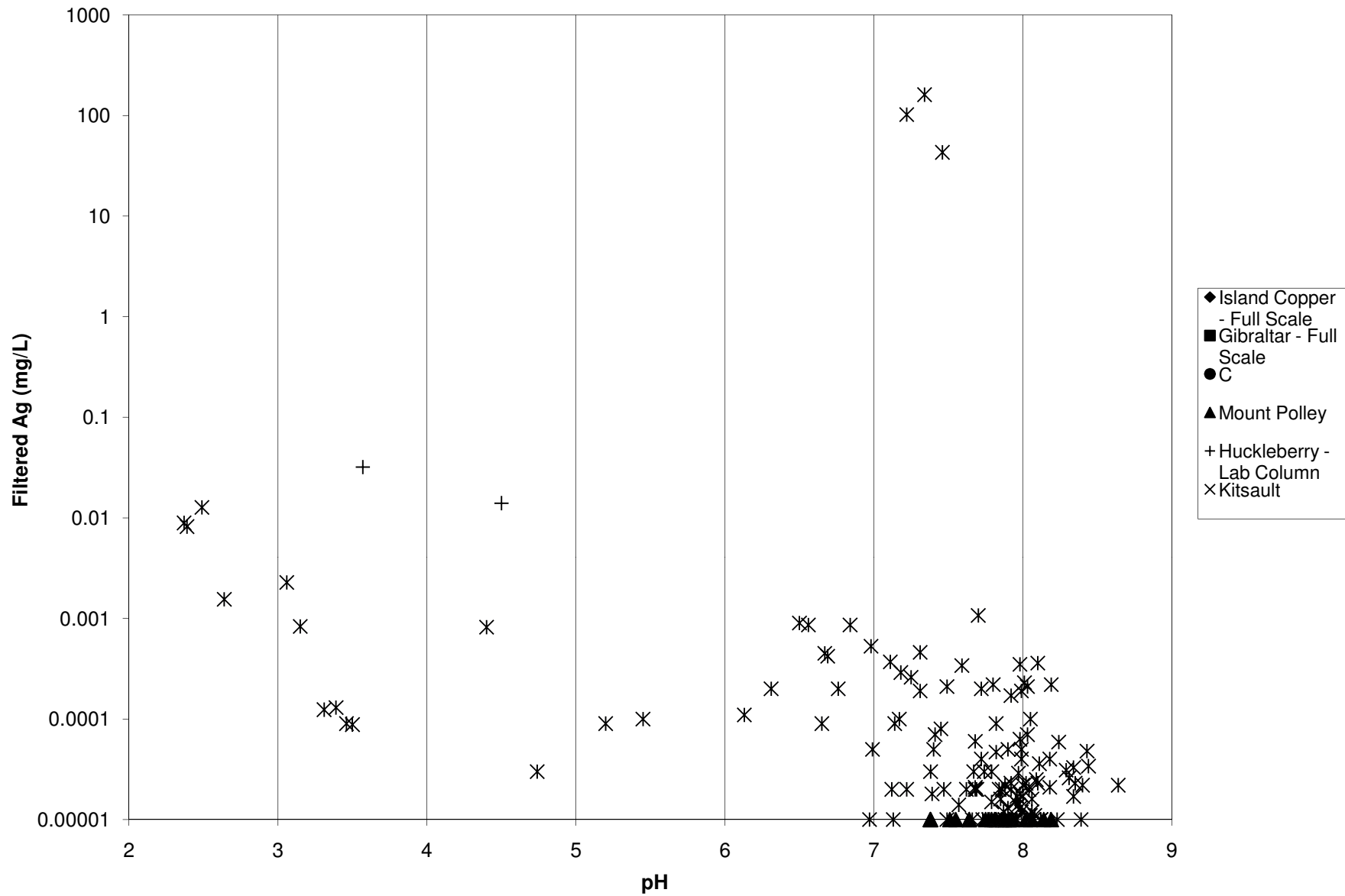



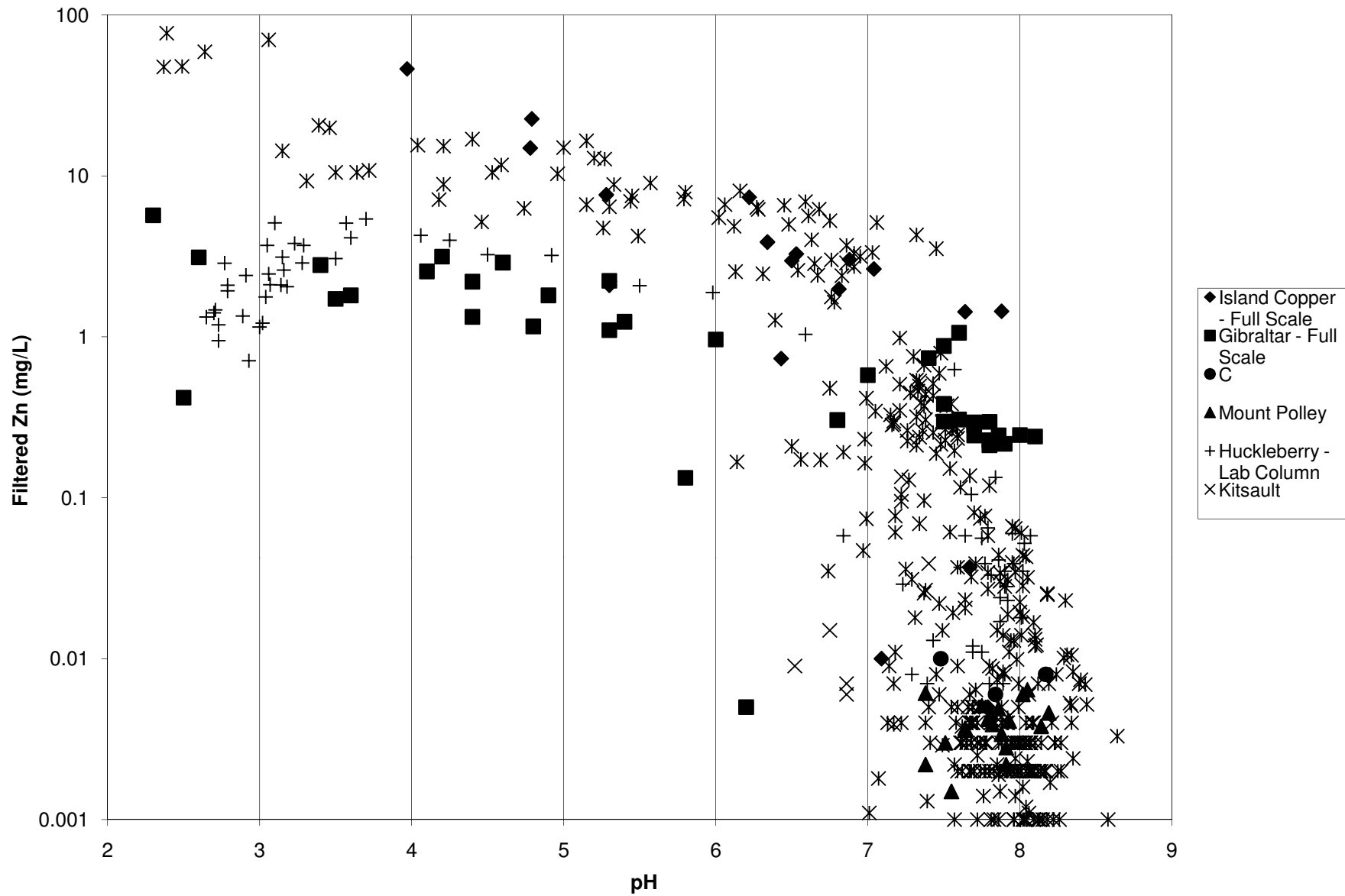

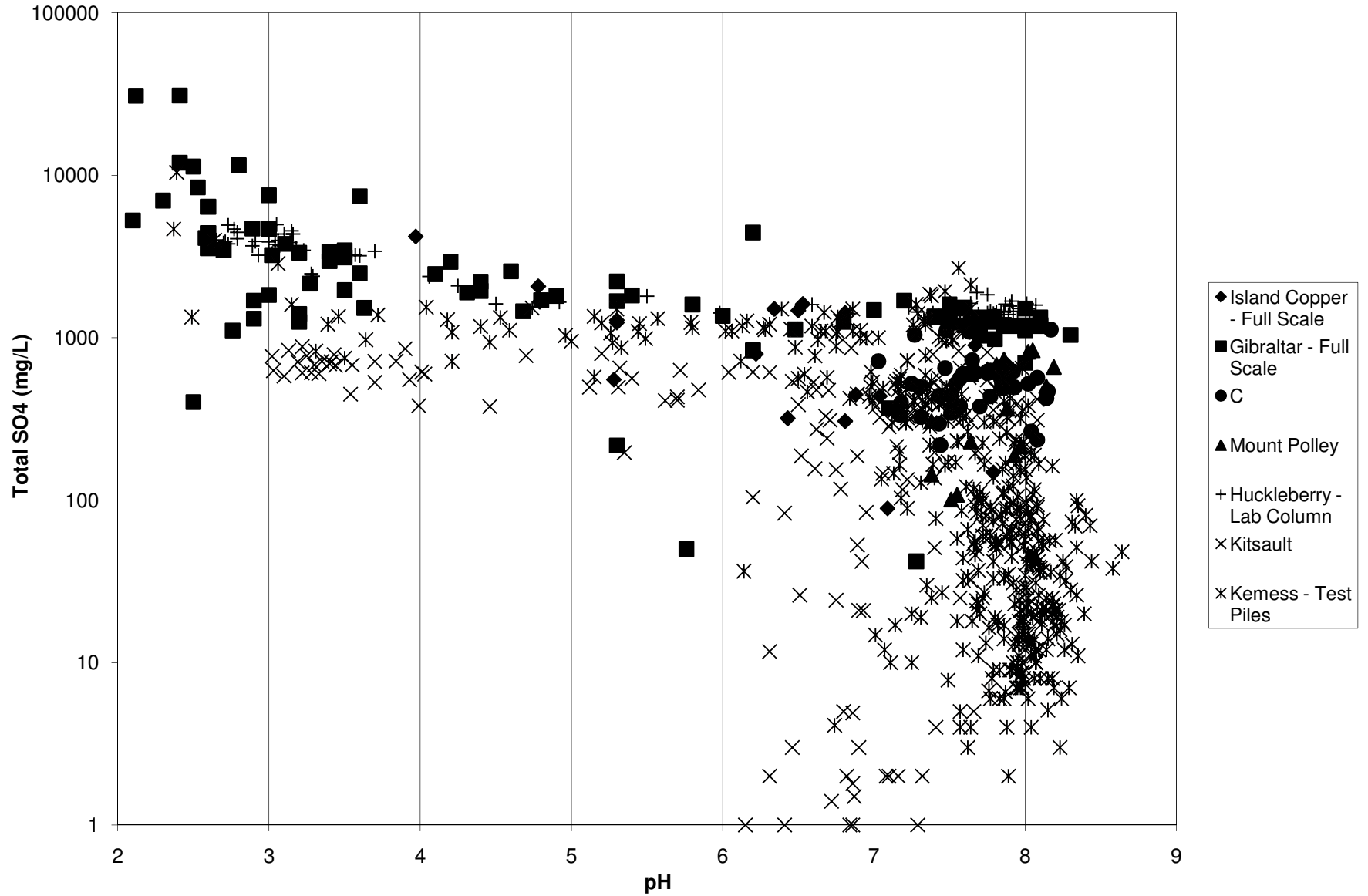

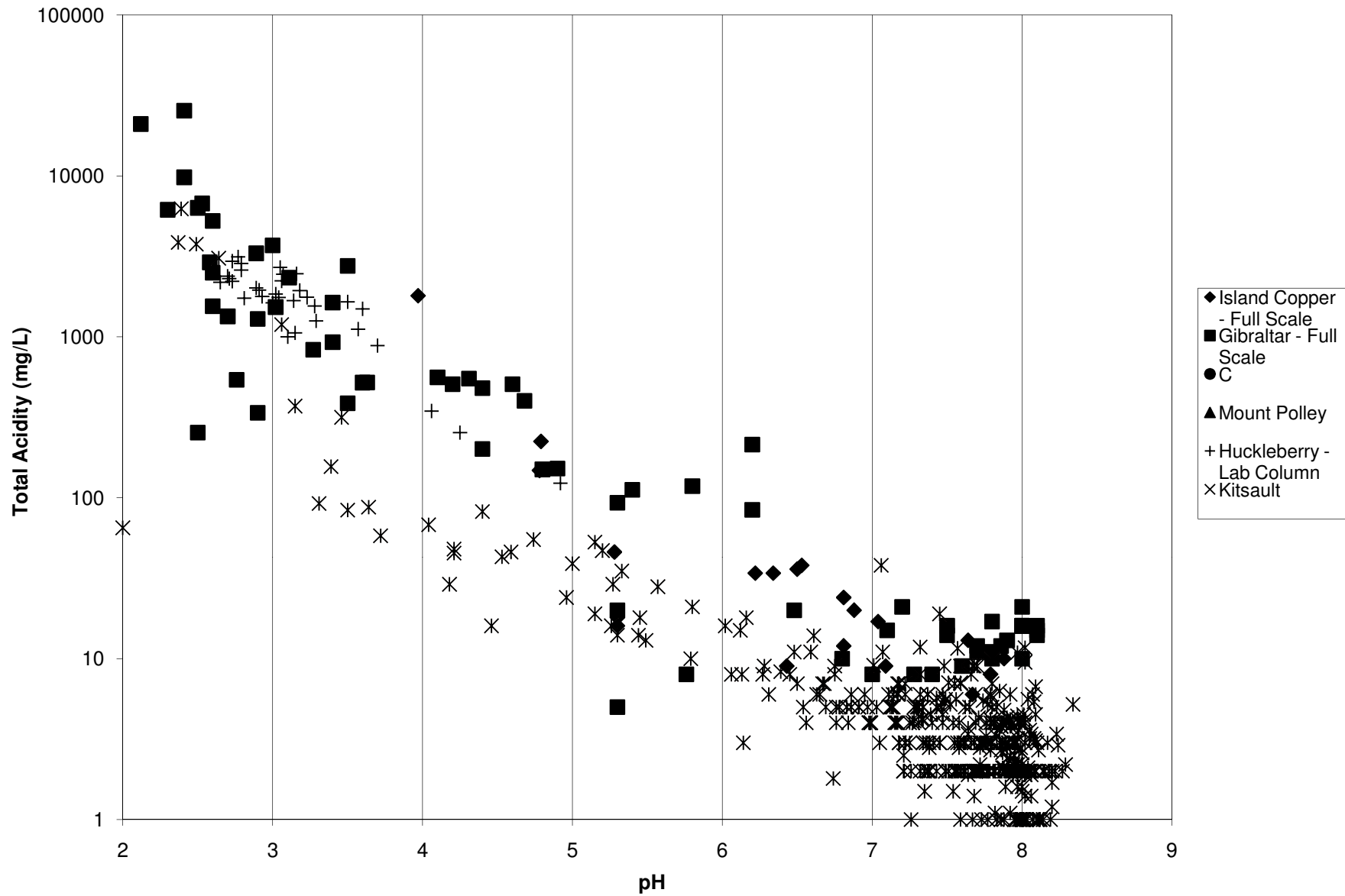

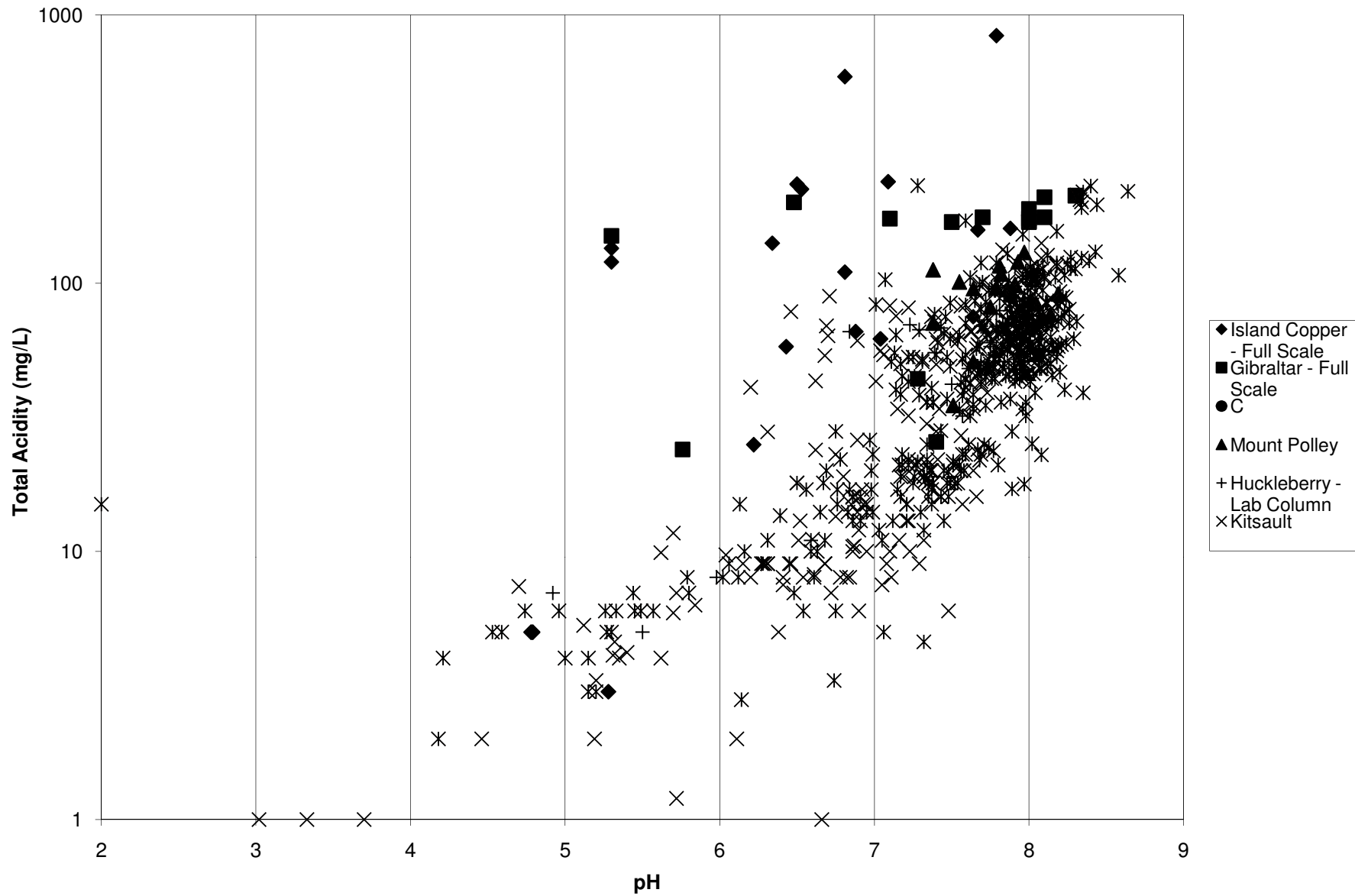







## Drainage Chemistry for Monitoring Location V32, Vangorda Mine Waste Rock Dump

STATION	YEAR	DATE	AG-D mg/L	AG-T mg/L	AL-D mg/L	ALK-T mg/L	AL-T mg/L	AS-D mg/L	AS-T mg/L	BA-D mg/L	BA-T mg/L	B-D mg/L	BE-D mg/L	BE-T mg/L	BI-D mg/L	BI-T mg/L	B-T mg/L	CA-D mg/L	CA-T mg/L	CD-D mg/L	CD-T mg/L
V32	1988	6/15/1988	#N/A	#N/A	#N/A	-1	#N/A	#N/A	#N/A	#N/A	#N/A	#N/A	#N/A	#N/A	#N/A	#N/A	#N/A	#N/A	#N/A	#N/A	#N/A
V32	1988	7/7/1988	#N/A	#N/A	#N/A	13.12	#N/A	#N/A	#N/A	#N/A	#N/A	#N/A	#N/A	#N/A	#N/A	#N/A	#N/A	#N/A	#N/A	#N/A	#N/A
V32	1988	7/11/1988	#N/A	#N/A	#N/A	13.12	#N/A	#N/A	#N/A	#N/A	#N/A	#N/A	#N/A	#N/A	#N/A	#N/A	#N/A	#N/A	#N/A	#N/A	#N/A
V32	1988	7/20/1988	#N/A	#N/A	#N/A	12.6	#N/A	#N/A	#N/A	#N/A	#N/A	#N/A	#N/A	#N/A	#N/A	#N/A	#N/A	#N/A	#N/A	#N/A	#N/A
V32	1988	7/27/1988	#N/A	#N/A	#N/A	12.6	#N/A	#N/A	#N/A	#N/A	#N/A	#N/A	#N/A	#N/A	#N/A	#N/A	#N/A	#N/A	#N/A	#N/A	#N/A
V32	1988	8/24/1988	#N/A	#N/A	#N/A	15.8	#N/A	#N/A	#N/A	#N/A	#N/A	#N/A	#N/A	#N/A	#N/A	#N/A	#N/A	#N/A	#N/A	#N/A	#N/A
V32	1988	8/24/1988	#N/A	#N/A	#N/A	#N/A	#N/A	#N/A	#N/A	#N/A	#N/A	#N/A	#N/A	#N/A	#N/A	#N/A	#N/A	#N/A	#N/A	#N/A	#N/A
V32	1988	9/13/1988	#N/A	#N/A	#N/A	14.5	#N/A	#N/A	#N/A	#N/A	#N/A	#N/A	#N/A	#N/A	#N/A	#N/A	#N/A	#N/A	#N/A	#N/A	#N/A
V32	1988	9/13/1988	#N/A	#N/A	#N/A	#N/A	#N/A	#N/A	#N/A	#N/A	#N/A	#N/A	#N/A	#N/A	#N/A	#N/A	#N/A	#N/A	#N/A	#N/A	#N/A
V32	1988	10/6/1988	#N/A	#N/A	#N/A	16	#N/A	#N/A	#N/A	#N/A	#N/A	#N/A	#N/A	#N/A	#N/A	#N/A	#N/A	#N/A	#N/A	#N/A	#N/A
V32	1988	10/6/1988	#N/A	#N/A	#N/A	#N/A	#N/A	#N/A	#N/A	#N/A	#N/A	#N/A	#N/A	#N/A	#N/A	#N/A	#N/A	#N/A	#N/A	#N/A	#N/A
V32	1994	8/9/1994	#N/A	0.009	#N/A	#N/A	4	#N/A	-0.02	#N/A	-0.0006	#N/A	#N/A	-0.0002	#N/A	#N/A	#N/A	#N/A	513	#N/A	0.558
V32	1994	8/9/1994	#N/A	#N/A	#N/A	#N/A	#N/A	#N/A	#N/A	#N/A	#N/A	#N/A	#N/A	#N/A	#N/A	#N/A	#N/A	#N/A	#N/A	#N/A	#N/A
V32	1994	8/9/1994	#N/A	#N/A	#N/A	#N/A	#N/A	#N/A	#N/A	#N/A	#N/A	#N/A	#N/A	#N/A	#N/A	#N/A	#N/A	#N/A	#N/A	#N/A	#N/A
V32	1994	8/9/1994	#N/A	#N/A	#N/A	#N/A	#N/A	#N/A	#N/A	#N/A	#N/A	#N/A	#N/A	#N/A	#N/A	#N/A	#N/A	#N/A	#N/A	#N/A	#N/A
V32	1994	8/9/1994	#N/A	#N/A	#N/A	0	#N/A	#N/A	#N/A	#N/A	#N/A	#N/A	#N/A	#N/A	#N/A	#N/A	#N/A	#N/A	#N/A	#N/A	#N/A
V32	1995	5/9/1995	#N/A	0.015	#N/A	-5	0.66	#N/A	-0.02	#N/A	0.0127	#N/A	#N/A	-0.0002	#N/A	#N/A	#N/A	#N/A	453	#N/A	0.146
V32	1995	5/9/1995	#N/A	#N/A	#N/A	#N/A	#N/A	#N/A	#N/A	#N/A	#N/A	#N/A	#N/A	#N/A	#N/A	#N/A	#N/A	#N/A	#N/A	#N/A	#N/A
V32	1995	5/9/1995	#N/A	#N/A	#N/A	#N/A	#N/A	#N/A	#N/A	#N/A	#N/A	#N/A	#N/A	#N/A	#N/A	#N/A	#N/A	#N/A	#N/A	#N/A	#N/A
V32	1995	5/9/1995	#N/A	#N/A	#N/A	#N/A	#N/A	#N/A	#N/A	#N/A	#N/A	#N/A	#N/A	#N/A	#N/A	#N/A	#N/A	#N/A	#N/A	#N/A	#N/A
V32	1996	5/27/1996	0.04	#N/A	2.6	-5	#N/A	-0.2	#N/A	0.35	#N/A	#N/A	0.09	#N/A	-0.4	#N/A	#N/A	426	#N/A	0.39	#N/A
V32	1996	5/27/1996	#N/A	#N/A	#N/A	#N/A	#N/A	#N/A	#N/A	#N/A	#N/A	#N/A	#N/A	#N/A	#N/A	#N/A	#N/A	#N/A	#N/A	#N/A	#N/A
V32	1996	9/11/1996	-0.03	#N/A	2.2	#N/A	#N/A	0.5	#N/A	0.46	#N/A	#N/A	0.02	#N/A	-0.4	#N/A	#N/A	412	#N/A	0.57	#N/A
V32	1996	9/11/1996	#N/A	#N/A	#N/A	#N/A	#N/A	#N/A	#N/A	#N/A	#N/A	#N/A	#N/A	#N/A	#N/A	#N/A	#N/A	#N/A	#N/A	#N/A	#N/A
V32	1996	9/11/1996	#N/A	#N/A	#N/A	#N/A	#N/A	#N/A	#N/A	#N/A	#N/A	#N/A	#N/A	#N/A	#N/A	#N/A	#N/A	#N/A	#N/A	#N/A	#N/A
V32	1997	5/12/1997	#N/A	0.034	#N/A	#N/A	1.68	#N/A	-0.02	#N/A	0.61	#N/A	#N/A	0.134	#N/A	0.37	4.98	#N/A	322.2	#N/A	0.556
V32	1997	5/12/1997	#N/A	#N/A	#N/A	#N/A	#N/A	#N/A	#N/A	#N/A	#N/A	#N/A	#N/A	#N/A	#N/A	#N/A	#N/A	#N/A	#N/A	#N/A	#N/A
V32	1997	5/12/1997	#N/A	#N/A	#N/A	0	#N/A	#N/A	#N/A	#N/A	#N/A	#N/A	#N/A	#N/A	#N/A	#N/A	#N/A	#N/A	#N/A	#N/A	#N/A
V32	1997	6/30/1997	-0.003	-0.003	7.29	-5	7.42	0.12	0.14	0.021	0.018	-0.05	0.006	0.006	-0.04	-0.04	-0.05	411.2	433.7	1.305	1.295
V32	1997	6/30/1997	#N/A	#N/A	#N/A	#N/A	#N/A	#N/A	#N/A	#N/A	#N/A	#N/A	#N/A	#N/A	#N/A	#N/A	#N/A	#N/A	#N/A	#N/A	#N/A
V32	1997	7/22/1997	#N/A	#N/A	16	#N/A	#N/A	1.2	#N/A	0.1	#N/A	3.8	#N/A	#N/A	1.1	#N/A	#N/A	364.7	#N/A	2	#N/A
V32	1997	7/22/1997	#N/A	#N/A	#N/A	#N/A	#N/A	#N/A	#N/A	#N/A	#N/A	#N/A	#N/A	#N/A	#N/A	#N/A	#N/A	#N/A	#N/A	#N/A	#N/A
V32	1997	7/22/1997	#N/A	#N/A	#N/A	#N/A	#N/A	#N/A	#N/A	#N/A	#N/A	#N/A	#N/A	#N/A	#N/A	#N/A	#N/A	#N/A	#N/A	#N/A	#N/A
V32	1997	8/6/1997	#N/A	#N/A	#N/A	#N/A	#N/A	#N/A	#N/A	#N/A	#N/A	#N/A	#N/A	#N/A	#N/A	#N/A	#N/A	#N/A	#N/A	#N/A	#N/A
V32	1997	8/11/1997	#N/A	0.08	#N/A	#N/A	5.38	#N/A	-0.02	#N/A	0.019	#N/A	#N/A	0.006	#N/A	-0.04	-0.05	#N/A	368	#N/A	1.4
V32	1997	8/11/1997	#N/A	#N/A	#N/A	#N/A	#N/A	#N/A	#N/A	#N/A	#N/A	#N/A	#N/A	#N/A	#N/A	#N/A	#N/A	#N/A	#N/A	#N/A	#N/A
V32	1997	8/11/1997	0.071	#N/A	4.97	#N/A	#N/A	-0.02	#N/A	0.018	#N/A	-0.05	0.006	#N/A	-0.04	#N/A	#N/A	342.5	#N/A	1.265	#N/A
V32	1997	9/30/1997	#N/A	#N/A	#N/A	#N/A	#N/A	#N/A	#N/A	#N/A	#N/A	#N/A	#N/A	#N/A	#N/A	#N/A	#N/A	#N/A	#N/A	#N/A	#N/A
V32	1997	9/30/1997	#N/A	#N/A	#N/A	#N/A	#N/A	#N/A	#N/A	#N/A	#N/A	#N/A	#N/A	#N/A	#N/A	#N/A	#N/A	#N/A	#N/A	#N/A	#N/A
V32	1997	9/30/1997	#N/A	0.039	#N/A	#N/A	5.04	#N/A	0.62	#N/A	0.799	#N/A	#N/A	0.008	#N/A	0.68	-0.05	#N/A	398.9	#N/A	2.247
V32	1997	9/30/1997	0.023	#N/A	3.54	#N/A	#N/A	1.01	#N/A	0.55	#N/A	0.09	0.008	#N/A	0.78	#N/A	#N/A	405.4	#N/A	2.243	#N/A
V32	1997	10/20/1997	0.03	#N/A	2.4	#N/A	#N/A	-0.02	#N/A	1.169	#N/A	1.24	0.299	#N/A	-0.04	#N/A	#N/A	430.3	#N/A	2.113	#N/A
V32	1997	10/20/1997	#N/A	#N/A	#N/A	#N/A	#N/A	#N/A	#N/A	#N/A	#N/A	#N/A	#N/A	#N/A	#N/A	#N/A	#N/A	#N/A	#N/A	#N/A	#N/A
V32	1997	10/20/1997	#N/A	#N/A	#N/A	#N/A	#N/A	#N/A	#N/A	#N/A	#N/A	#N/A	#N/A	#N/A	#N/A	#N/A	#N/A	#N/A	#N/A	#N/A	#N/A
V32	1997	12/22/1997	0.007	#N/A	2.92	#N/A	#N/A	0.09	#N/A	0.553	#N/A	1.32	0.3	#N/A	-0.04	#N/A	#N/A	390.3	#N/A	1.91	#N/A
V32	1997	12/22/1997	#N/A	#N/A	#N/A	#N/A	#N/A	#N/A	#N/A	#N/A	#N/A	#N/A	#N/A	#N/A	#N/A	#N/A	#N/A	#N/A	#N/A	#N/A	#N/A
V32	1998	5/18/1998	0.059	#N/A	3.2	-5	#N/A	0.59	#N/A	0.101	#N/A	-0.05	0.005	#N/A	-0.04	#N/A	#N/A	335.4	#N/A	1.59	#N/A
V32	1998	5/18/1998	#N/A	#N/A	#N/A	#N/A	#N/A	#N/A	#N/A	#N/A	#N/A	#N/A	#N/A	#N/A	#N/A	#N/A	#N/A	#N/A	#N/A	#N/A	#N/A
V32	1998	6/29/1998	0.137	#N/A	4.56	#N/A	#N/A	2.11	#N/A	0.664	#N/A	0.07	0.012	#N/A	1.26	#N/A	#N/A	447	#N/A	3.86	#N/A
V32	1998	6/29/1998	#N/A	#N/A	#N/A	#N/A	#N/A	#N/A	#N/A	#N/A	#N/A	#N/A	#N/A	#N/A	#N/A	#N/A	#N/A	#N/A	#N/A	#N/A	#N/A
V32	1998	6/29/1998	#N/A	#N/A	#N/A	#N/A	#N/A	#N/A	#N/A	#N/A	#N/A	#N/A	#N/A	#N/A	#N/A	#N/A	#N/A	#N/A	#N/A	#N/A	#N/A
V32	1998	9/14/1998	0.174	#N/A	7.6	#N/A	#N/A	1.44	#N/A	0.294	#N/A	-0.05	0.001	#N/A	-0.04	#N/A	#N/A	407	#N/A	3.953	#N/A
V32	1998	9/14/1998	#N/A	#N/A	#N/A	#N/A	#N/A	#N/A	#N/A	#N/A	#N/A	#N/A	#N/A	#N/A	#N/A	#N/A	#N/A	#N/A	#N/A	#N/A	#N/A
V32	1998	9/14/1998	#N/A	#N/A	#N/A	#N/A	#N/A	#N/A	#N/A	#N/A	#N/A	#N/A	#N/A	#N/A	#N/A	#N/A	#N/A	#N/A	#N/A	#N/A	#N/A



## Drainage Chemistry for Monitoring Location V32, Vangorda Mine Waste Rock Dump

STATION	YEAR	DATE	AG-D mg/L	AG-T mg/L	AL-D mg/L	ALK-T mg/L	AL-T mg/L	AS-D mg/L	AS-T mg/L	BA-D mg/L	BA-T mg/L	B-D mg/L	BE-D mg/L	BE-T mg/L	BI-D mg/L	BI-T mg/L	B-T mg/L	CA-D mg/L	CA-T mg/L	CD-D mg/L	CD-T mg/L
V32	1999	5/18/1999	0.103	#N/A	1.38	#N/A	#N/A	0.048	#N/A	0.177	#N/A	-0.05	0.007	#N/A	-0.04	#N/A	#N/A	349.5	#N/A	2.025	#N/A
V32	1999	5/18/1999	#N/A	#N/A	#N/A	#N/A	#N/A	#N/A	#N/A	#N/A	#N/A	#N/A	#N/A	#N/A	#N/A	#N/A	#N/A	#N/A	#N/A	#N/A	#N/A
V32	1999	6/18/1999	-0.003	#N/A	2.22	#N/A	#N/A	-0.005	#N/A	0.523	#N/A	-0.05	0.009	#N/A	-0.04	#N/A	#N/A	400.2	#N/A	2.909	#N/A
V32	1999	6/18/1999	#N/A	#N/A	#N/A	#N/A	#N/A	#N/A	#N/A	#N/A	#N/A	#N/A	#N/A	#N/A	#N/A	#N/A	#N/A	#N/A	#N/A	#N/A	#N/A
V32	1999	8/12/1999	#N/A	#N/A	0.94	#N/A	#N/A	2.414	#N/A	#N/A	#N/A	2.44	0.038	#N/A	-0.04	#N/A	#N/A	455.4	#N/A	6.316	#N/A
V32	1999	8/12/1999	#N/A	#N/A	#N/A	#N/A	#N/A	#N/A	#N/A	#N/A	#N/A	#N/A	#N/A	#N/A	#N/A	#N/A	#N/A	#N/A	#N/A	#N/A	#N/A
V32	1999	8/12/1999	0.517	#N/A	#N/A	#N/A	#N/A	#N/A	#N/A	1.655	#N/A	#N/A	#N/A	#N/A	#N/A	#N/A	#N/A	#N/A	#N/A	#N/A	#N/A
V32	1999	10/12/1999	-0.003	#N/A	6.03	-5	#N/A	-0.005	#N/A	0.382	#N/A	0.06	0.006	#N/A	-0.04	#N/A	#N/A	394.1	#N/A	5.496	#N/A
V32	1999	10/12/1999	#N/A	#N/A	#N/A	#N/A	#N/A	#N/A	#N/A	#N/A	#N/A	#N/A	#N/A	#N/A	#N/A	#N/A	#N/A	#N/A	#N/A	#N/A	#N/A
V32	1999	10/12/1999	#N/A	#N/A	#N/A	#N/A	#N/A	#N/A	#N/A	#N/A	#N/A	#N/A	#N/A	#N/A	#N/A	#N/A	#N/A	#N/A	#N/A	#N/A	#N/A
V32	1999	12/13/1999	-0.003	#N/A	6.2	#N/A	#N/A	0.419	#N/A	0.979	#N/A	2.23	0.135	#N/A	-0.04	#N/A	#N/A	406.6	#N/A	4.359	#N/A
V32	1999	12/13/1999	#N/A	#N/A	#N/A	#N/A	#N/A	#N/A	#N/A	#N/A	#N/A	#N/A	#N/A	#N/A	#N/A	#N/A	#N/A	#N/A	#N/A	#N/A	#N/A
V32	1999	12/13/1999	#N/A	#N/A	#N/A	#N/A	#N/A	#N/A	#N/A	#N/A	#N/A	#N/A	#N/A	#N/A	#N/A	#N/A	#N/A	#N/A	#N/A	#N/A	#N/A
V32	2000	5/31/2000	0.148	#N/A	7.89	#N/A	#N/A	-0.005	#N/A	0.423	#N/A	0.42	0.007	#N/A	-0.05	#N/A	#N/A	448.7	#N/A	4.763	#N/A
V32	2000	5/31/2000	#N/A	#N/A	#N/A	#N/A	#N/A	#N/A	#N/A	#N/A	#N/A	#N/A	#N/A	#N/A	#N/A	#N/A	#N/A	#N/A	#N/A	#N/A	#N/A
V32	2000	5/31/2000	#N/A	#N/A	#N/A	#N/A	#N/A	#N/A	#N/A	#N/A	#N/A	#N/A	#N/A	#N/A	#N/A	#N/A	#N/A	#N/A	#N/A	#N/A	#N/A
V32	2000	9/12/2000	0.015	#N/A	8.44	#N/A	#N/A	1.02	#N/A	0.083	#N/A	-0.05	0.009	#N/A	-0.05	#N/A	#N/A	354.6	#N/A	4.23	#N/A
V32	2000	9/12/2000	#N/A	#N/A	#N/A	#N/A	#N/A	#N/A	#N/A	#N/A	#N/A	#N/A	#N/A	#N/A	#N/A	#N/A	#N/A	#N/A	#N/A	#N/A	#N/A
V32	2001	6/13/2001	0.163	#N/A	15.73	#N/A	#N/A	0.014	#N/A	0.078	#N/A	1.2	-0.001	#N/A	0.08	#N/A	#N/A	335.2	#N/A	8.976	#N/A
V32	2001	6/13/2001	#N/A	#N/A	#N/A	#N/A	#N/A	#N/A	#N/A	#N/A	#N/A	#N/A	#N/A	#N/A	#N/A	#N/A	#N/A	#N/A	#N/A	#N/A	#N/A
V32	2001	6/13/2001	#N/A	#N/A	#N/A	#N/A	#N/A	#N/A	#N/A	#N/A	#N/A	#N/A	#N/A	#N/A	#N/A	#N/A	#N/A	#N/A	#N/A	#N/A	#N/A
V32	2003	6/17/2003	0.0007	#N/A	21.965	#N/A	22.089	0.007	#N/A	0.008	0.008	1.3	0.0057	0.0057	0.09	0.08	1.32	478.1	472.8	5.6536	5.5935
V32	2003	6/17/2003	#N/A	0.0008	#N/A	#N/A	#N/A	#N/A	0.007	#N/A	#N/A	#N/A	#N/A	#N/A	#N/A	#N/A	#N/A	#N/A	#N/A	#N/A	#N/A
V32	2003	9/15/2003	0.0294	#N/A	41.248	#N/A	#N/A	0.748	#N/A	0.009	#N/A	1.46	0.0075	#N/A	0.11	#N/A	#N/A	485.9	#N/A	6.7453	#N/A
V32	2003	9/15/2003	#N/A	#N/A	#N/A	#N/A	#N/A	#N/A	#N/A	#N/A	#N/A	#N/A	#N/A	#N/A	#N/A	#N/A	#N/A	#N/A	#N/A	#N/A	#N/A
V32	2004	6/28/2004	-0.00025	#N/A	#N/A	#N/A	#N/A	0.032	#N/A	0.016	#N/A	-0.05	0.01	#N/A	-0.001	#N/A	#N/A	488	#N/A	8.26	#N/A
V32	2004	6/28/2004	#N/A	#N/A	#N/A	#N/A	#N/A	#N/A	#N/A	#N/A	#N/A	#N/A	#N/A	#N/A	#N/A	#N/A	#N/A	#N/A	#N/A	#N/A	#N/A
V32	2004	6/28/2004	#N/A	#N/A	220	#N/A	#N/A	#N/A	#N/A	#N/A	#N/A	#N/A	#N/A	#N/A	#N/A	#N/A	#N/A	#N/A	#N/A	#N/A	#N/A
V32	2004	9/20/2004	-0.00025	#N/A	193	#N/A	#N/A	0.018	#N/A	0.007	#N/A	-0.05	0.016	#N/A	-0.001	#N/A	#N/A	403	#N/A	#N/A	#N/A
V32	2004	9/20/2004	#N/A	#N/A	#N/A	#N/A	#N/A	#N/A	#N/A	#N/A	#N/A	#N/A	#N/A	#N/A	#N/A	#N/A	#N/A	#N/A	#N/A	#N/A	#N/A
V32	2004	9/20/2004	#N/A	#N/A	#N/A	#N/A	#N/A	#N/A	#N/A	#N/A	#N/A	#N/A	#N/A	#N/A	#N/A	#N/A	#N/A	#N/A	#N/A	#N/A	#N/A
V32	2005	6/22/2005	-0.00025	#N/A	363	#N/A	#N/A	0.018	#N/A	0.007	#N/A	-0.05	0.023	#N/A	-0.001	#N/A	#N/A	499	#N/A	19.9	#N/A
V32	2005	6/22/2005	#N/A	#N/A	#N/A	#N/A	#N/A	#N/A	#N/A	#N/A	#N/A	#N/A	#N/A	#N/A	#N/A	#N/A	#N/A	#N/A	#N/A	#N/A	#N/A
V32	2005	9/19/2005	-0.00025	#N/A	290	#N/A	#N/A	0.024	#N/A	0.008	#N/A	-0.05	0.016	#N/A	-0.001	#N/A	#N/A	469	#N/A	14.8	#N/A
V32	2005	9/19/2005	#N/A	#N/A	#N/A	#N/A	#N/A	#N/A	#N/A	#N/A	#N/A	#N/A	#N/A	#N/A	#N/A	#N/A	#N/A	#N/A	#N/A	#N/A	#N/A
V32	2006	6/8/2006	-0.00025	#N/A	160	#N/A	#N/A	0.015	#N/A	0.005	#N/A	-0.05	0.011	#N/A	-0.001	#N/A	#N/A	334	#N/A	7.33	#N/A
V32	2006	9/18/2006	0.011	#N/A	131	#N/A	#N/A	0.016	#N/A	0.006	#N/A	-0.05	0.01	#N/A	-0.001	#N/A	#N/A	407	#N/A	5.77	#N/A
V32	2007	6/11/2007	0.017	#N/A	221	#N/A	#N/A	0.011	#N/A	0.004	#N/A	-0.05	0.017	#N/A	-0.001	#N/A	#N/A	366	#N/A	5.03	#N/A
V32	2007	10/1/2007	#N/A	#N/A	353	#N/A	#N/A	#N/A	#N/A	-0.1	#N/A	#N/A	-0.3	#N/A	#N/A	#N/A	#N/A	425	#N/A	10	#N/A
V32	2008	6/1/2008	0.027	#N/A	691	#N/A	#N/A	0.017	#N/A	0.005	#N/A	-0.05	0.02	#N/A	-0.001	#N/A	#N/A	437	#N/A	6.36	#N/A
V32	2008	9/29/2008	0.02	#N/A	482	#N/A	#N/A	0.013	#N/A	0.007	#N/A	-0.05	0.025	#N/A	-0.001	#N/A	#N/A	374	#N/A	9.88	#N/A

## Drainage Chemistry for Monitoring Location V32, Vangorda Mine Waste Rock Dump

STATION	YEAR	DATE	CN-T mg/L	LN-WAD mg	CO-D mg/L	COLOR CU	DND-F μS	DND-L μS/d	CO-T mg/L	CR-D mg/L	CR-T mg/L	CU-D mg/L	CU-T mg/L	DO mg/L	DO-% %	DOC mg/L	FE-D mg/L	FE-T mg/L	OWLS L/s	WM3S m <sup>3</sup>	HARD mg/L	
V32	1988	6/15/1988	#N/A	#N/A	#N/A	#N/A	#N/A	#N/A	#N/A	#N/A	#N/A	#N/A	#N/A	#N/A	#N/A	#N/A	#N/A	#N/A	#N/A	#N/A	#N/A	#N/A
V32	1988	7/7/1988	#N/A	#N/A	#N/A	#N/A	#N/A	#N/A	#N/A	#N/A	#N/A	#N/A	#N/A	#N/A	#N/A	#N/A	#N/A	#N/A	#N/A	#N/A	#N/A	#N/A
V32	1988	7/11/1988	#N/A	#N/A	#N/A	#N/A	#N/A	#N/A	#N/A	#N/A	#N/A	#N/A	#N/A	#N/A	#N/A	#N/A	#N/A	#N/A	#N/A	#N/A	#N/A	#N/A
V32	1988	7/20/1988	#N/A	#N/A	#N/A	#N/A	#N/A	#N/A	#N/A	#N/A	#N/A	#N/A	#N/A	#N/A	#N/A	#N/A	#N/A	#N/A	#N/A	#N/A	#N/A	#N/A
V32	1988	7/27/1988	#N/A	#N/A	#N/A	#N/A	#N/A	#N/A	#N/A	#N/A	#N/A	#N/A	#N/A	#N/A	#N/A	#N/A	#N/A	#N/A	#N/A	#N/A	#N/A	#N/A
V32	1988	8/24/1988	#N/A	#N/A	#N/A	#N/A	#N/A	#N/A	#N/A	#N/A	#N/A	#N/A	#N/A	0.002	#N/A	#N/A	#N/A	#N/A	#N/A	#N/A	#N/A	#N/A
V32	1988	8/24/1988	#N/A	#N/A	#N/A	#N/A	#N/A	#N/A	#N/A	#N/A	#N/A	#N/A	#N/A	#N/A	#N/A	#N/A	#N/A	#N/A	#N/A	#N/A	#N/A	#N/A
V32	1988	9/13/1988	#N/A	#N/A	#N/A	#N/A	#N/A	#N/A	#N/A	#N/A	#N/A	#N/A	#N/A	0.002	#N/A	#N/A	#N/A	#N/A	#N/A	#N/A	#N/A	#N/A
V32	1988	9/13/1988	#N/A	#N/A	#N/A	#N/A	#N/A	#N/A	#N/A	#N/A	#N/A	#N/A	#N/A	#N/A	#N/A	#N/A	#N/A	#N/A	#N/A	#N/A	#N/A	#N/A
V32	1988	10/6/1988	#N/A	#N/A	#N/A	#N/A	#N/A	#N/A	#N/A	#N/A	#N/A	#N/A	#N/A	-0.002	#N/A	#N/A	#N/A	#N/A	0.095	#N/A	#N/A	#N/A
V32	1988	10/6/1988	#N/A	#N/A	#N/A	#N/A	#N/A	#N/A	#N/A	#N/A	#N/A	#N/A	#N/A	#N/A	#N/A	#N/A	#N/A	#N/A	#N/A	#N/A	#N/A	#N/A
V32	1994	8/9/1994	#N/A	#N/A	#N/A	#N/A	7200	#N/A	15	#N/A	-0.001	#N/A	-0.002	#N/A	#N/A	#N/A	#N/A	#N/A	0.807	#N/A	#N/A	4240
V32	1994	8/9/1994	#N/A	#N/A	#N/A	#N/A	#N/A	6900	#N/A	#N/A	#N/A	#N/A	#N/A	#N/A	#N/A	#N/A	#N/A	#N/A	#N/A	#N/A	#N/A	#N/A
V32	1994	8/9/1994	#N/A	#N/A	#N/A	#N/A	#N/A	#N/A	#N/A	#N/A	#N/A	#N/A	#N/A	#N/A	#N/A	#N/A	#N/A	#N/A	#N/A	#N/A	#N/A	#N/A
V32	1994	8/9/1994	#N/A	#N/A	#N/A	#N/A	#N/A	#N/A	#N/A	#N/A	#N/A	#N/A	#N/A	#N/A	#N/A	#N/A	#N/A	#N/A	#N/A	#N/A	0	#N/A
V32	1994	8/9/1994	#N/A	#N/A	#N/A	#N/A	#N/A	#N/A	#N/A	#N/A	#N/A	#N/A	#N/A	#N/A	#N/A	#N/A	#N/A	#N/A	#N/A	#N/A	#N/A	#N/A
V32	1995	5/9/1995	#N/A	#N/A	#N/A	#N/A	7090	#N/A	10.1	#N/A	0.036	#N/A	-0.002	#N/A	#N/A	#N/A	#N/A	#N/A	112	#N/A	#N/A	4
V32	1995	5/9/1995	#N/A	#N/A	#N/A	#N/A	#N/A	6600	#N/A	#N/A	#N/A	#N/A	#N/A	#N/A	#N/A	#N/A	#N/A	#N/A	#N/A	#N/A	#N/A	#N/A
V32	1995	5/9/1995	#N/A	#N/A	#N/A	#N/A	#N/A	#N/A	#N/A	#N/A	#N/A	#N/A	#N/A	#N/A	#N/A	#N/A	#N/A	#N/A	#N/A	#N/A	#N/A	#N/A
V32	1995	5/9/1995	#N/A	#N/A	#N/A	#N/A	#N/A	#N/A	#N/A	#N/A	#N/A	#N/A	#N/A	#N/A	#N/A	#N/A	#N/A	#N/A	#N/A	#N/A	0	#N/A
V32	1996	5/27/1996	#N/A	#N/A	6.62	#N/A	#N/A	3008	#N/A	-0.05	#N/A	0.06	#N/A	#N/A	#N/A	#N/A	#N/A	17.7	#N/A	0.019	#N/A	2389
V32	1996	5/27/1996	#N/A	#N/A	#N/A	#N/A	#N/A	#N/A	#N/A	#N/A	#N/A	#N/A	#N/A	#N/A	#N/A	#N/A	#N/A	#N/A	#N/A	#N/A	#N/A	#N/A
V32	1996	9/11/1996	#N/A	#N/A	7.43	#N/A	#N/A	9220	#N/A	-0.05	#N/A	0.12	#N/A	#N/A	#N/A	#N/A	#N/A	36.8	#N/A	#N/A	#N/A	#N/A
V32	1996	9/11/1996	#N/A	#N/A	#N/A	#N/A	#N/A	#N/A	#N/A	#N/A	#N/A	#N/A	#N/A	#N/A	#N/A	#N/A	#N/A	#N/A	#N/A	#N/A	#N/A	#N/A
V32	1996	9/11/1996	#N/A	#N/A	#N/A	#N/A	#N/A	#N/A	#N/A	#N/A	#N/A	#N/A	#N/A	#N/A	#N/A	#N/A	#N/A	#N/A	#N/A	#N/A	#N/A	#N/A
V32	1997	5/12/1997	#N/A	#N/A	#N/A	#N/A	#N/A	5150	6.392	#N/A	-0.005	#N/A	0.09	#N/A	#N/A	#N/A	#N/A	#N/A	33.81	0.02	#N/A	#N/A
V32	1997	5/12/1997	#N/A	#N/A	#N/A	#N/A	#N/A	#N/A	#N/A	#N/A	#N/A	#N/A	#N/A	#N/A	#N/A	#N/A	#N/A	#N/A	#N/A	#N/A	#N/A	#N/A
V32	1997	5/12/1997	#N/A	#N/A	#N/A	#N/A	#N/A	#N/A	#N/A	#N/A	#N/A	#N/A	#N/A	#N/A	#N/A	#N/A	#N/A	#N/A	#N/A	#N/A	#N/A	#N/A
V32	1997	6/30/1997	#N/A	#N/A	10.175	#N/A	#N/A	9120	10.378	-0.005	-0.005	0.079	0.094	#N/A	#N/A	#N/A	#N/A	2.29	18.23	0.05	#N/A	#N/A
V32	1997	6/30/1997	#N/A	#N/A	#N/A	#N/A	#N/A	#N/A	#N/A	#N/A	#N/A	#N/A	#N/A	#N/A	#N/A	#N/A	#N/A	#N/A	#N/A	#N/A	#N/A	#N/A
V32	1997	7/22/1997	#N/A	#N/A	12.1	#N/A	#N/A	9550	#N/A	-0.005	#N/A	0.1	#N/A	#N/A	#N/A	#N/A	#N/A	28.3	#N/A	0.02	#N/A	#N/A
V32	1997	7/22/1997	#N/A	#N/A	#N/A	#N/A	#N/A	#N/A	#N/A	#N/A	#N/A	#N/A	#N/A	#N/A	#N/A	#N/A	#N/A	#N/A	#N/A	#N/A	#N/A	#N/A
V32	1997	7/22/1997	#N/A	#N/A	#N/A	#N/A	#N/A	#N/A	#N/A	#N/A	#N/A	#N/A	#N/A	#N/A	#N/A	#N/A	#N/A	#N/A	#N/A	#N/A	#N/A	#N/A
V32	1997	8/6/1997	#N/A	#N/A	#N/A	#N/A	#N/A	#N/A	#N/A	#N/A	#N/A	#N/A	#N/A	#N/A	#N/A	#N/A	#N/A	#N/A	#N/A	#N/A	0.02	#N/A
V32	1997	8/11/1997	#N/A	#N/A	#N/A	#N/A	#N/A	#N/A	10.503	#N/A	-0.005	#N/A	0.106	#N/A	#N/A	#N/A	#N/A	#N/A	27.79	0.02	#N/A	#N/A
V32	1997	8/11/1997	#N/A	#N/A	#N/A	#N/A	#N/A	#N/A	#N/A	#N/A	#N/A	#N/A	#N/A	#N/A	#N/A	#N/A	#N/A	#N/A	#N/A	#N/A	#N/A	#N/A
V32	1997	8/11/1997	#N/A	#N/A	9.917	#N/A	#N/A	#N/A	#N/A	-0.005	#N/A	0.079	#N/A	#N/A	#N/A	#N/A	#N/A	15.02	#N/A	#N/A	#N/A	#N/A
V32	1997	9/30/1997	#N/A	#N/A	#N/A	#N/A	#N/A	9950	#N/A	#N/A	#N/A	#N/A	#N/A	#N/A	#N/A	#N/A	#N/A	#N/A	#N/A	#N/A	0.02	#N/A
V32	1997	9/30/1997	#N/A	#N/A	#N/A	#N/A	#N/A	#N/A	#N/A	#N/A	#N/A	#N/A	#N/A	#N/A	#N/A	#N/A	#N/A	#N/A	#N/A	#N/A	#N/A	#N/A
V32	1997	9/30/1997	#N/A	#N/A	#N/A	#N/A	#N/A	#N/A	11.2	#N/A	-0.005	#N/A	0.138	#N/A	#N/A	#N/A	#N/A	#N/A	22.21	#N/A	#N/A	#N/A
V32	1997	9/30/1997	#N/A	#N/A	11.215	#N/A	#N/A	#N/A	#N/A	-0.005	#N/A	0.077	#N/A	#N/A	#N/A	#N/A	#N/A	16.25	#N/A	#N/A	#N/A	#N/A
V32	1997	10/20/1997	#N/A	#N/A	11.76	#N/A	#N/A	10250	#N/A	-0.005	#N/A	0.122	#N/A	#N/A	#N/A	#N/A	#N/A	2.87	#N/A	0.008	#N/A	#N/A
V32	1997	10/20/1997	#N/A	#N/A	#N/A	#N/A	#N/A	#N/A	#N/A	#N/A	#N/A	#N/A	#N/A	#N/A	#N/A	#N/A	#N/A	#N/A	#N/A	#N/A	#N/A	#N/A
V32	1997	10/20/1997	#N/A	#N/A	#N/A	#N/A	#N/A	#N/A	#N/A	#N/A	#N/A	#N/A	#N/A	#N/A	#N/A	#N/A	#N/A	#N/A	#N/A	#N/A	#N/A	#N/A
V32	1997	12/22/1997	#N/A	#N/A	11.489	#N/A	#N/A	#N/A	#N/A	-0.005	#N/A	0.12	#N/A	#N/A	#N/A	#N/A	#N/A	36.43	#N/A	0.004	#N/A	#N/A
V32	1997	12/22/1997	#N/A	#N/A	#N/A	#N/A	#N/A	#N/A	#N/A	#N/A	#N/A	#N/A	#N/A	#N/A	#N/A	#N/A	#N/A	#N/A	#N/A	#N/A	#N/A	#N/A
V32	1998	5/18/1998	#N/A	#N/A	6.82	#N/A	#N/A	#N/A	#N/A	-0.005	#N/A	0.092	#N/A	#N/A	#N/A	#N/A	#N/A	9.15	#N/A	0.008	#N/A	#N/A
V32	1998	5/18/1998	#N/A	#N/A	#N/A	#N/A	#N/A	#N/A	#N/A	#N/A	#N/A	#N/A	#N/A	#N/A	#N/A	#N/A	#N/A	#N/A	#N/A	#N/A	#N/A	#N/A
V32	1998	6/29/1998	#N/A	#N/A	12.419	#N/A	#N/A	#N/A	#N/A	#N/A	#N/A	#N/A	#N/A	#N/A	#N/A	#N/A	#N/A	55.98	#N/A	0.03	#N/A	#N/A
V32	1998	6/29/1998	#N/A	#N/A	#N/A	#N/A	#N/A	#N/A	#N/A	#N/A	#N/A	#N/A	#N/A	#N/A	#N/A	#N/A	#N/A	#N/A	#N/A	#N/A	#N/A	#N/A
V32	1998	6/29/1998	#N/A	#N/A	#N/A	#N/A	#N/A	#N/A	#N/A	0.87	#N/A	#N/A	#N/A	#N/A	#N/A	#N/A	#N/A	#N/A	#N/A	#N/A	#N/A	#N/A
V32	1998	9/14/1998	#N/A	#N/A	13.682	#N/A	#N/A	#N/A	#N/A	#N/A	#N/A	#N/A	#N/A	#N/A	#N/A	#N/A	#N/A	38.17	#N/A	0.02	#N/A	#N/A
V32	1998	9/14/1998	#N/A	#N/A	#N/A	#N/A	#N/A	#N/A	#N/A	#N/A	#N/A	#N/A	#N/A	#N/A	#N/A	#N/A	#N/A	#N/A	#N/A	#N/A	#N/A	#N/A
V32	1998	9/14/1998	#N/A	#N/A	#N/A	#N/A	#N/A	#N/A	#N/A	0.816	#N/A	#N/A	#N/A	#N/A	#N/A	#N/A	#N/A	#N/A	#N/A	#N/A	#N/A	#N/A

Drainage Chemistry for Monitoring Location V32, Vangorda Mine Waste Rock Dump

STATION	YEAR	DATE	CN-T mg/L	N-WAD mg	CO-D mg/L	COLOR CU	DND-F μS	DND-L μS/d	CO-T mg/L	CR-D mg/L	CR-T mg/L	CU-D mg/L	CU-T mg/L	DO mg/L	DO-% %	DOC mg/L	FE-D mg/L	FE-T mg/L	OWLS L/s	WM3S m^3	HARD mg/L
V32	1999	5/18/1999	#N/A	#N/A	9.669	#N/A	#N/A	#N/A	#N/A	-0.005	#N/A	0.199	#N/A	#N/A	#N/A	#N/A	127.98	#N/A	0.01	#N/A	#N/A
V32	1999	5/18/1999	#N/A	#N/A	#N/A	#N/A	#N/A	#N/A	#N/A	#N/A	#N/A	#N/A	#N/A	#N/A	#N/A	#N/A	#N/A	#N/A	#N/A	#N/A	#N/A
V32	1999	6/18/1999	#N/A	#N/A	11.939	#N/A	#N/A	#N/A	#N/A	0.177	#N/A	0.11	#N/A	#N/A	#N/A	#N/A	224.27	#N/A	0.018	#N/A	#N/A
V32	1999	6/18/1999	#N/A	#N/A	#N/A	#N/A	#N/A	#N/A	#N/A	#N/A	#N/A	#N/A	#N/A	#N/A	#N/A	#N/A	#N/A	#N/A	#N/A	#N/A	#N/A
V32	1999	8/12/1999	#N/A	#N/A	15.582	#N/A	#N/A	#N/A	#N/A	-0.005	#N/A	0.087	#N/A	#N/A	#N/A	#N/A	167.3	#N/A	0.019	#N/A	#N/A
V32	1999	8/12/1999	#N/A	#N/A	#N/A	#N/A	#N/A	#N/A	#N/A	#N/A	#N/A	#N/A	#N/A	#N/A	#N/A	#N/A	#N/A	#N/A	#N/A	#N/A	#N/A
V32	1999	8/12/1999	#N/A	#N/A	#N/A	#N/A	#N/A	#N/A	#N/A	#N/A	#N/A	#N/A	#N/A	#N/A	#N/A	#N/A	#N/A	#N/A	#N/A	#N/A	#N/A
V32	1999	10/12/1999	#N/A	#N/A	9.901	#N/A	#N/A	#N/A	#N/A	-0.005	#N/A	0.114	#N/A	#N/A	#N/A	#N/A	123.7	#N/A	0.03	#N/A	#N/A
V32	1999	10/12/1999	#N/A	#N/A	#N/A	#N/A	#N/A	15200	#N/A	#N/A	#N/A	#N/A	#N/A	#N/A	#N/A	#N/A	#N/A	#N/A	#N/A	#N/A	#N/A
V32	1999	10/12/1999	#N/A	#N/A	#N/A	#N/A	#N/A	#N/A	#N/A	#N/A	#N/A	#N/A	#N/A	#N/A	#N/A	#N/A	#N/A	#N/A	#N/A	#N/A	#N/A
V32	1999	12/13/1999	#N/A	#N/A	22.105	#N/A	#N/A	#N/A	#N/A	-0.005	#N/A	0.375	#N/A	#N/A	#N/A	#N/A	188.88	#N/A	#N/A	#N/A	#N/A
V32	1999	12/13/1999	#N/A	#N/A	#N/A	#N/A	#N/A	#N/A	#N/A	#N/A	#N/A	#N/A	#N/A	#N/A	#N/A	#N/A	#N/A	#N/A	#N/A	#N/A	#N/A
V32	1999	12/13/1999	#N/A	#N/A	#N/A	#N/A	#N/A	#N/A	#N/A	#N/A	#N/A	#N/A	#N/A	#N/A	#N/A	#N/A	#N/A	#N/A	#N/A	#N/A	#N/A
V32	2000	5/31/2000	#N/A	#N/A	12.425	#N/A	#N/A	#N/A	#N/A	-0.005	#N/A	0.112	#N/A	#N/A	#N/A	#N/A	315	#N/A	#N/A	#N/A	#N/A
V32	2000	5/31/2000	#N/A	#N/A	#N/A	#N/A	#N/A	#N/A	#N/A	#N/A	#N/A	#N/A	#N/A	#N/A	#N/A	#N/A	#N/A	#N/A	#N/A	#N/A	#N/A
V32	2000	5/31/2000	#N/A	#N/A	#N/A	#N/A	#N/A	#N/A	#N/A	#N/A	#N/A	#N/A	#N/A	#N/A	#N/A	#N/A	#N/A	#N/A	0.1	#N/A	#N/A
V32	2000	9/12/2000	#N/A	#N/A	11.41	#N/A	#N/A	#N/A	#N/A	0.082	#N/A	0.204	#N/A	#N/A	#N/A	#N/A	273.3	#N/A	#N/A	#N/A	#N/A
V32	2000	9/12/2000	#N/A	#N/A	#N/A	#N/A	#N/A	#N/A	#N/A	#N/A	#N/A	#N/A	#N/A	#N/A	#N/A	#N/A	#N/A	#N/A	#N/A	#N/A	#N/A
V32	2001	6/13/2001	#N/A	#N/A	19.088	#N/A	#N/A	#N/A	#N/A	-0.005	#N/A	0.105	#N/A	#N/A	#N/A	#N/A	679.08	#N/A	#N/A	#N/A	#N/A
V32	2001	6/13/2001	#N/A	#N/A	#N/A	#N/A	#N/A	#N/A	#N/A	#N/A	#N/A	#N/A	#N/A	#N/A	#N/A	#N/A	#N/A	#N/A	#N/A	#N/A	#N/A
V32	2001	6/13/2001	#N/A	#N/A	#N/A	#N/A	#N/A	#N/A	#N/A	#N/A	#N/A	#N/A	#N/A	#N/A	#N/A	#N/A	#N/A	#N/A	#N/A	#N/A	#N/A
V32	2003	6/17/2003	#N/A	#N/A	14.027	#N/A	#N/A	#N/A	13.967	-0.001	-0.001	0.103	0.117	#N/A	#N/A	#N/A	714.108	890.457	#N/A	#N/A	#N/A
V32	2003	6/17/2003	#N/A	#N/A	#N/A	#N/A	#N/A	#N/A	#N/A	#N/A	#N/A	#N/A	#N/A	#N/A	#N/A	#N/A	#N/A	#N/A	#N/A	#N/A	#N/A
V32	2003	9/15/2003	#N/A	#N/A	22.158	#N/A	#N/A	#N/A	#N/A	-0.001	#N/A	#N/A	#N/A	#N/A	#N/A	#N/A	1135.386	#N/A	#N/A	#N/A	#N/A
V32	2003	9/15/2003	#N/A	#N/A	#N/A	#N/A	#N/A	#N/A	#N/A	#N/A	#N/A	0.483	#N/A	#N/A	#N/A	#N/A	#N/A	#N/A	#N/A	#N/A	#N/A
V32	2004	6/28/2004	#N/A	#N/A	26.1	#N/A	#N/A	#N/A	#N/A	0.016	#N/A	0.11	#N/A	#N/A	#N/A	#N/A	1360	#N/A	#N/A	#N/A	#N/A
V32	2004	6/28/2004	#N/A	#N/A	#N/A	#N/A	#N/A	47900	#N/A	#N/A	#N/A	#N/A	#N/A	#N/A	#N/A	#N/A	#N/A	#N/A	#N/A	#N/A	#N/A
V32	2004	6/28/2004	#N/A	#N/A	#N/A	#N/A	#N/A	#N/A	#N/A	#N/A	#N/A	#N/A	#N/A	#N/A	#N/A	#N/A	#N/A	#N/A	#N/A	#N/A	#N/A
V32	2004	9/20/2004	#N/A	#N/A	30.8	#N/A	#N/A	#N/A	#N/A	0.011	#N/A	0.048	#N/A	#N/A	#N/A	#N/A	#N/A	#N/A	#N/A	#N/A	#N/A
V32	2004	9/20/2004	#N/A	#N/A	#N/A	#N/A	#N/A	102000	#N/A	#N/A	#N/A	#N/A	#N/A	#N/A	#N/A	#N/A	#N/A	#N/A	#N/A	#N/A	#N/A
V32	2004	9/20/2004	#N/A	#N/A	#N/A	#N/A	#N/A	#N/A	#N/A	#N/A	#N/A	#N/A	#N/A	#N/A	#N/A	#N/A	2330	#N/A	#N/A	#N/A	#N/A
V32	2005	6/22/2005	#N/A	#N/A	21.8	#N/A	#N/A	#N/A	#N/A	0.01	#N/A	0.037	#N/A	#N/A	#N/A	#N/A	2970	#N/A	#N/A	#N/A	#N/A
V32	2005	6/22/2005	#N/A	#N/A	#N/A	#N/A	#N/A	72400	#N/A	#N/A	#N/A	#N/A	#N/A	#N/A	#N/A	#N/A	#N/A	#N/A	#N/A	#N/A	#N/A
V32	2005	9/19/2005	#N/A	#N/A	29.7	#N/A	#N/A	#N/A	#N/A	0.011	#N/A	0.031	#N/A	#N/A	#N/A	#N/A	2930	#N/A	#N/A	#N/A	#N/A
V32	2005	9/19/2005	#N/A	#N/A	#N/A	#N/A	#N/A	85000	#N/A	#N/A	#N/A	#N/A	#N/A	#N/A	#N/A	#N/A	#N/A	#N/A	#N/A	#N/A	#N/A
V32	2006	6/8/2006	#N/A	#N/A	21.7	#N/A	#N/A	#N/A	#N/A	0.012	#N/A	0.039	#N/A	#N/A	#N/A	#N/A	3240	#N/A	#N/A	#N/A	#N/A
V32	2006	9/18/2006	#N/A	#N/A	24.4	#N/A	#N/A	#N/A	#N/A	0.009	#N/A	0.017	#N/A	#N/A	#N/A	#N/A	3260	#N/A	#N/A	#N/A	#N/A
V32	2007	6/11/2007	#N/A	#N/A	23.8	#N/A	#N/A	97000	#N/A	0.017	#N/A	0.044	#N/A	#N/A	#N/A	#N/A	3650	#N/A	#N/A	#N/A	#N/A
V32	2007	10/1/2007	#N/A	#N/A	26	#N/A	#N/A	98100	#N/A	#N/A	#N/A	#N/A	#N/A	#N/A	#N/A	#N/A	3870	#N/A	#N/A	#N/A	#N/A
V32	2008	6/1/2008	#N/A	#N/A	26.6	#N/A	#N/A	129000	#N/A	0.018	#N/A	0.035	#N/A	#N/A	#N/A	#N/A	5080	#N/A	#N/A	#N/A	#N/A
V32	2008	9/29/2008	#N/A	#N/A	19.6	#N/A	#N/A	77500	#N/A	0.025	#N/A	0.32	#N/A	#N/A	#N/A	#N/A	2710	#N/A	#N/A	#N/A	#N/A

## Drainage Chemistry for Monitoring Location V32, Vangorda Mine Waste Rock Dump

STATION	YEAR	DATE	ARD-C mg/L	HG-D mg/L	HG-T mg/L	K-D mg/L	K-T mg/L	LA-D mg/L	LA-T mg/L	LC50 %v/v	LI-D mg/L	LI-T mg/L	MG-D mg/L	MG-T mg/L	MN-D mg/L	MN-T mg/L	MO-D mg/L	MO-T mg/L	NA-D mg/L	NA-T mg/L	NH3 mg/L		
V32	1988	6/15/1988	#N/A	#N/A	#N/A	#N/A	#N/A	#N/A	#N/A	#N/A	#N/A	#N/A	#N/A	#N/A	#N/A	#N/A	#N/A	#N/A	#N/A	#N/A	#N/A	#N/A	
V32	1988	7/7/1988	#N/A	#N/A	#N/A	#N/A	#N/A	#N/A	#N/A	#N/A	#N/A	#N/A	#N/A	#N/A	#N/A	#N/A	#N/A	#N/A	#N/A	#N/A	#N/A	#N/A	
V32	1988	7/11/1988	#N/A	#N/A	#N/A	#N/A	#N/A	#N/A	#N/A	#N/A	#N/A	#N/A	#N/A	#N/A	#N/A	#N/A	#N/A	#N/A	#N/A	#N/A	#N/A	#N/A	
V32	1988	7/20/1988	#N/A	#N/A	#N/A	#N/A	#N/A	#N/A	#N/A	#N/A	#N/A	#N/A	#N/A	#N/A	#N/A	#N/A	#N/A	#N/A	#N/A	#N/A	#N/A	#N/A	
V32	1988	7/27/1988	#N/A	#N/A	#N/A	#N/A	#N/A	#N/A	#N/A	#N/A	#N/A	#N/A	#N/A	#N/A	#N/A	#N/A	#N/A	#N/A	#N/A	#N/A	#N/A	#N/A	
V32	1988	8/24/1988	#N/A	#N/A	#N/A	#N/A	#N/A	#N/A	#N/A	#N/A	#N/A	#N/A	#N/A	#N/A	#N/A	#N/A	0.006	#N/A	#N/A	#N/A	#N/A	1.8	0.73
V32	1988	8/24/1988	#N/A	#N/A	#N/A	#N/A	#N/A	#N/A	#N/A	#N/A	#N/A	#N/A	#N/A	#N/A	#N/A	#N/A	#N/A	#N/A	#N/A	#N/A	#N/A	#N/A	
V32	1988	9/13/1988	#N/A	#N/A	#N/A	#N/A	#N/A	#N/A	#N/A	#N/A	#N/A	#N/A	#N/A	#N/A	#N/A	#N/A	0.007	#N/A	#N/A	#N/A	#N/A	1.8	0.46
V32	1988	9/13/1988	#N/A	#N/A	#N/A	#N/A	#N/A	#N/A	#N/A	#N/A	#N/A	#N/A	#N/A	#N/A	#N/A	#N/A	#N/A	#N/A	#N/A	#N/A	#N/A	#N/A	
V32	1988	10/6/1988	#N/A	#N/A	#N/A	#N/A	#N/A	#N/A	#N/A	#N/A	#N/A	#N/A	#N/A	#N/A	#N/A	#N/A	0.002	#N/A	#N/A	#N/A	#N/A	1.6	0.1
V32	1988	10/6/1988	#N/A	#N/A	#N/A	#N/A	#N/A	#N/A	#N/A	#N/A	#N/A	#N/A	#N/A	#N/A	#N/A	#N/A	#N/A	#N/A	#N/A	#N/A	#N/A	#N/A	
V32	1994	8/9/1994	#N/A	#N/A	#N/A	#N/A	26	#N/A	#N/A	#N/A	#N/A	#N/A	#N/A	542	#N/A	387	#N/A	-0.005	#N/A	#N/A	14.8	6	
V32	1994	8/9/1994	#N/A	#N/A	#N/A	#N/A	#N/A	#N/A	#N/A	#N/A	#N/A	#N/A	#N/A	#N/A	#N/A	#N/A	#N/A	#N/A	#N/A	#N/A	#N/A	#N/A	
V32	1994	8/9/1994	#N/A	#N/A	#N/A	#N/A	#N/A	#N/A	#N/A	#N/A	#N/A	#N/A	#N/A	#N/A	#N/A	#N/A	#N/A	#N/A	#N/A	#N/A	#N/A	#N/A	
V32	1994	8/9/1994	#N/A	#N/A	#N/A	#N/A	#N/A	#N/A	#N/A	#N/A	#N/A	#N/A	#N/A	#N/A	#N/A	#N/A	#N/A	#N/A	#N/A	#N/A	#N/A	#N/A	
V32	1994	8/9/1994	#N/A	#N/A	#N/A	#N/A	#N/A	#N/A	#N/A	#N/A	#N/A	#N/A	#N/A	#N/A	#N/A	#N/A	#N/A	#N/A	#N/A	#N/A	#N/A	#N/A	
V32	1995	5/9/1995	#N/A	#N/A	#N/A	#N/A	20	#N/A	#N/A	#N/A	#N/A	#N/A	#N/A	543	#N/A	380	#N/A	-0.005	#N/A	#N/A	13.4	5	
V32	1995	5/9/1995	#N/A	#N/A	#N/A	#N/A	#N/A	#N/A	#N/A	#N/A	#N/A	#N/A	#N/A	#N/A	#N/A	#N/A	#N/A	#N/A	#N/A	#N/A	#N/A	#N/A	
V32	1995	5/9/1995	#N/A	#N/A	#N/A	#N/A	#N/A	#N/A	#N/A	#N/A	#N/A	#N/A	#N/A	#N/A	#N/A	#N/A	#N/A	#N/A	#N/A	#N/A	#N/A	#N/A	
V32	1995	5/9/1995	#N/A	#N/A	#N/A	#N/A	#N/A	#N/A	#N/A	#N/A	#N/A	#N/A	#N/A	#N/A	#N/A	#N/A	#N/A	#N/A	#N/A	#N/A	#N/A	#N/A	
V32	1996	5/27/1996	#N/A	-0.2	#N/A	#N/A	#N/A	-0.05	#N/A	#N/A	#N/A	#N/A	378	#N/A	244.5	#N/A	0.02	#N/A	#N/A	27	#N/A	13.52	
V32	1996	5/27/1996	#N/A	#N/A	#N/A	#N/A	#N/A	#N/A	#N/A	#N/A	#N/A	#N/A	#N/A	#N/A	#N/A	#N/A	#N/A	#N/A	#N/A	#N/A	#N/A	#N/A	
V32	1996	9/11/1996	#N/A	-0.2	#N/A	#N/A	#N/A	-0.05	#N/A	#N/A	#N/A	#N/A	578	#N/A	371.1	#N/A	0.04	#N/A	#N/A	#N/A	#N/A	4.73	
V32	1996	9/11/1996	#N/A	#N/A	#N/A	#N/A	#N/A	#N/A	#N/A	#N/A	#N/A	#N/A	#N/A	#N/A	#N/A	#N/A	#N/A	#N/A	#N/A	#N/A	#N/A	#N/A	
V32	1996	9/11/1996	#N/A	#N/A	#N/A	#N/A	#N/A	#N/A	#N/A	#N/A	#N/A	#N/A	#N/A	#N/A	#N/A	#N/A	#N/A	#N/A	#N/A	#N/A	122	#N/A	#N/A
V32	1997	5/12/1997	#N/A	#N/A	#N/A	#N/A	-1	#N/A	0.417	#N/A	#N/A	#N/A	#N/A	426.3	#N/A	305.5	#N/A	-0.002	#N/A	#N/A	19	4.93	
V32	1997	5/12/1997	#N/A	#N/A	#N/A	#N/A	#N/A	#N/A	#N/A	#N/A	#N/A	#N/A	#N/A	#N/A	#N/A	#N/A	#N/A	#N/A	#N/A	#N/A	#N/A	#N/A	
V32	1997	5/12/1997	#N/A	#N/A	#N/A	#N/A	#N/A	#N/A	#N/A	#N/A	#N/A	#N/A	#N/A	#N/A	#N/A	#N/A	#N/A	#N/A	#N/A	#N/A	#N/A	#N/A	
V32	1997	6/30/1997	#N/A	#N/A	#N/A	20	20	0.172	0.158	#N/A	#N/A	#N/A	929.2	928.5	#N/A	#N/A	1.515	1.559	16	15	3.16	#N/A	
V32	1997	6/30/1997	#N/A	#N/A	#N/A	#N/A	#N/A	#N/A	#N/A	#N/A	#N/A	#N/A	#N/A	#N/A	#N/A	#N/A	#N/A	#N/A	#N/A	#N/A	#N/A	#N/A	
V32	1997	7/22/1997	#N/A	#N/A	#N/A	17	#N/A	0.2	#N/A	#N/A	#N/A	#N/A	862	#N/A	779.5	#N/A	2.4	#N/A	29	#N/A	6.7	#N/A	
V32	1997	7/22/1997	#N/A	#N/A	#N/A	#N/A	#N/A	#N/A	#N/A	#N/A	#N/A	#N/A	#N/A	#N/A	#N/A	#N/A	#N/A	#N/A	#N/A	#N/A	#N/A	#N/A	
V32	1997	7/22/1997	#N/A	#N/A	#N/A	#N/A	#N/A	#N/A	#N/A	#N/A	#N/A	#N/A	#N/A	#N/A	#N/A	#N/A	#N/A	#N/A	#N/A	#N/A	#N/A	#N/A	
V32	1997	8/6/1997	#N/A	#N/A	#N/A	#N/A	#N/A	#N/A	#N/A	#N/A	#N/A	#N/A	#N/A	#N/A	#N/A	#N/A	#N/A	#N/A	#N/A	#N/A	#N/A	#N/A	
V32	1997	8/11/1997	#N/A	#N/A	#N/A	#N/A	18	#N/A	0.144	#N/A	#N/A	#N/A	#N/A	885.6	#N/A	536.2	#N/A	1.5	#N/A	14	8.79	#N/A	
V32	1997	8/11/1997	#N/A	#N/A	#N/A	#N/A	#N/A	#N/A	#N/A	#N/A	#N/A	#N/A	#N/A	#N/A	#N/A	#N/A	#N/A	#N/A	#N/A	#N/A	#N/A	#N/A	
V32	1997	8/11/1997	#N/A	#N/A	#N/A	19	#N/A	0.164	#N/A	#N/A	#N/A	#N/A	835.1	#N/A	492.74	#N/A	1.425	#N/A	13	#N/A	#N/A	#N/A	
V32	1997	9/30/1997	#N/A	#N/A	#N/A	#N/A	#N/A	#N/A	#N/A	#N/A	#N/A	#N/A	#N/A	#N/A	#N/A	#N/A	#N/A	#N/A	#N/A	#N/A	#N/A	6.69	
V32	1997	9/30/1997	#N/A	#N/A	#N/A	#N/A	#N/A	#N/A	#N/A	#N/A	#N/A	#N/A	#N/A	#N/A	#N/A	#N/A	#N/A	#N/A	#N/A	#N/A	#N/A	#N/A	
V32	1997	9/30/1997	#N/A	#N/A	#N/A	#N/A	16	#N/A	0.306	#N/A	#N/A	#N/A	#N/A	930.5	#N/A	591.3	#N/A	2.306	#N/A	37	#N/A	#N/A	
V32	1997	9/30/1997	#N/A	#N/A	#N/A	12	#N/A	0.375	#N/A	#N/A	#N/A	#N/A	953.8	#N/A	606.21	#N/A	2.224	#N/A	36	#N/A	#N/A	#N/A	
V32	1997	10/20/1997	#N/A	#N/A	#N/A	26	#N/A	0.202	#N/A	#N/A	#N/A	#N/A	1041	#N/A	750.48	#N/A	0.248	#N/A	39	#N/A	7.14	#N/A	
V32	1997	10/20/1997	#N/A	#N/A	#N/A	#N/A	#N/A	#N/A	#N/A	#N/A	#N/A	#N/A	#N/A	#N/A	#N/A	#N/A	#N/A	#N/A	#N/A	#N/A	#N/A	#N/A	
V32	1997	10/20/1997	#N/A	#N/A	#N/A	#N/A	#N/A	#N/A	#N/A	#N/A	#N/A	#N/A	#N/A	#N/A	#N/A	#N/A	#N/A	#N/A	#N/A	#N/A	#N/A	#N/A	
V32	1997	12/22/1997	#N/A	#N/A	#N/A	7	#N/A	0.023	#N/A	#N/A	#N/A	#N/A	972.7	#N/A	685.28	#N/A	-0.002	#N/A	28	#N/A	6.35	#N/A	
V32	1997	12/22/1997	#N/A	#N/A	#N/A	#N/A	#N/A	#N/A	#N/A	#N/A	#N/A	#N/A	#N/A	#N/A	#N/A	#N/A	#N/A	#N/A	#N/A	#N/A	#N/A	#N/A	
V32	1998	5/18/1998	#N/A	#N/A	#N/A	15	#N/A	-0.005	#N/A	#N/A	#N/A	#N/A	584.2	#N/A	316.6	#N/A	0.98	#N/A	12	#N/A	-0.05	#N/A	
V32	1998	5/18/1998	#N/A	#N/A	#N/A	#N/A	#N/A	#N/A	#N/A	#N/A	#N/A	#N/A	#N/A	#N/A	#N/A	#N/A	#N/A	#N/A	#N/A	#N/A	#N/A	#N/A	
V32	1998	6/29/1998	#N/A	#N/A	#N/A	17	#N/A	0.215	#N/A	#N/A	#N/A	#N/A	1000	#N/A	665.74	#N/A	2.479	#N/A	23	#N/A	-0.05	#N/A	
V32	1998	6/29/1998	#N/A	#N/A	#N/A	#N/A	#N/A	#N/A	#N/A	#N/A	#N/A	#N/A	#N/A	#N/A	#N/A	#N/A	#N/A	#N/A	#N/A	#N/A	#N/A	#N/A	
V32	1998	6/29/1998	#N/A	#N/A	#N/A	#N/A	#N/A	#N/A	#N/A	#N/A	#N/A	#N/A	#N/A	#N/A	#N/A	#N/A	#N/A	#N/A	#N/A	#N/A	#N/A	#N/A	
V32	1998	9/14/1998	#N/A	#N/A	#N/A	18	#N/A	0.336	#N/A	#N/A	#N/A	#N/A	1000	#N/A	940.35	#N/A	2.974	#N/A	22	#N/A	-0.05	#N/A	
V32	1998	9/14/1998	#N/A	#N/A	#N/A	#N/A	#N/A	#N/A	#N/A	#N/A	#N/A	#N/A	#N/A	#N/A	#N/A	#N/A	#N/A	#N/A	#N/A	#N/A	#N/A	#N/A	
V32	1998	9/14/1998	#N/A	#N/A	#N/A	#N/A	#N/A	#N/A	#N/A	#N/A	#N/A	#N/A	#N/A	#N/A	#N/A	#N/A	#N/A	#N/A	#N/A	#N/A	#N/A	#N/A	

## Drainage Chemistry for Monitoring Location V32, Vangorda Mine Waste Rock Dump

STATION	YEAR	DATE	ARD-C mg/L	HG-D mg/L	HG-T mg/L	K-D mg/L	K-T mg/L	LA-D mg/L	LA-T mg/L	LC50 %v/v	LI-D mg/L	LI-T mg/L	MG-D mg/L	MG-T mg/L	MN-D mg/L	MN-T mg/L	MO-D mg/L	MO-T mg/L	NA-D mg/L	NA-T mg/L	NH3 mg/L
V32	1999	5/18/1999	#N/A	#N/A	#N/A	15	#N/A	-0.005	#N/A	#N/A	#N/A	#N/A	767	#N/A	419.04	#N/A	0.839	#N/A	14	#N/A	1.36
V32	1999	5/18/1999	#N/A	#N/A	#N/A	#N/A	#N/A	#N/A	#N/A	#N/A	#N/A	#N/A	#N/A	#N/A	#N/A	#N/A	#N/A	#N/A	#N/A	#N/A	#N/A
V32	1999	6/18/1999	#N/A	#N/A	#N/A	28	#N/A	0.349	#N/A	#N/A	#N/A	#N/A	1038.1	#N/A	661.68	#N/A	3.064	#N/A	22	#N/A	0.29
V32	1999	6/18/1999	#N/A	#N/A	#N/A	#N/A	#N/A	#N/A	#N/A	#N/A	#N/A	#N/A	#N/A	#N/A	#N/A	#N/A	#N/A	#N/A	#N/A	#N/A	#N/A
V32	1999	8/12/1999	#N/A	#N/A	#N/A	-1	#N/A	0.294	#N/A	#N/A	#N/A	#N/A	1740	#N/A	1245.81	#N/A	1.792	#N/A	-1	#N/A	#N/A
V32	1999	8/12/1999	#N/A	#N/A	#N/A	#N/A	#N/A	#N/A	#N/A	#N/A	#N/A	#N/A	#N/A	#N/A	#N/A	#N/A	#N/A	#N/A	#N/A	#N/A	#N/A
V32	1999	8/12/1999	#N/A	#N/A	#N/A	#N/A	#N/A	#N/A	#N/A	#N/A	#N/A	#N/A	#N/A	#N/A	#N/A	#N/A	#N/A	#N/A	#N/A	#N/A	#N/A
V32	1999	10/12/1999	#N/A	#N/A	#N/A	14	#N/A	-0.005	#N/A	#N/A	#N/A	#N/A	1581.1	#N/A	979.15	#N/A	5.188	#N/A	12	#N/A	-0.05
V32	1999	10/12/1999	#N/A	#N/A	#N/A	#N/A	#N/A	#N/A	#N/A	#N/A	#N/A	#N/A	#N/A	#N/A	#N/A	#N/A	#N/A	#N/A	#N/A	#N/A	#N/A
V32	1999	10/12/1999	#N/A	#N/A	#N/A	#N/A	#N/A	#N/A	#N/A	#N/A	#N/A	#N/A	#N/A	#N/A	#N/A	#N/A	#N/A	#N/A	#N/A	#N/A	#N/A
V32	1999	12/13/1999	#N/A	#N/A	#N/A	8	#N/A	-0.005	#N/A	#N/A	#N/A	#N/A	1498.6	#N/A	-0.01	#N/A	#N/A	#N/A	17	#N/A	#N/A
V32	1999	12/13/1999	#N/A	#N/A	#N/A	#N/A	#N/A	#N/A	#N/A	#N/A	#N/A	#N/A	#N/A	#N/A	#N/A	#N/A	#N/A	#N/A	#N/A	#N/A	#N/A
V32	1999	12/13/1999	#N/A	#N/A	#N/A	#N/A	#N/A	#N/A	#N/A	#N/A	#N/A	#N/A	#N/A	#N/A	#N/A	#N/A	98.693	#N/A	#N/A	#N/A	#N/A
V32	2000	5/31/2000	#N/A	#N/A	#N/A	13	#N/A	-0.005	#N/A	#N/A	#N/A	#N/A	1342	#N/A	1199	#N/A	1.941	#N/A	11	#N/A	#N/A
V32	2000	5/31/2000	#N/A	#N/A	#N/A	#N/A	#N/A	#N/A	#N/A	#N/A	#N/A	#N/A	#N/A	#N/A	#N/A	#N/A	#N/A	#N/A	#N/A	#N/A	#N/A
V32	2000	5/31/2000	#N/A	#N/A	#N/A	#N/A	#N/A	#N/A	#N/A	#N/A	#N/A	#N/A	#N/A	#N/A	#N/A	#N/A	#N/A	#N/A	#N/A	#N/A	#N/A
V32	2000	9/12/2000	#N/A	#N/A	#N/A	15	#N/A	0.54	#N/A	#N/A	#N/A	#N/A	1394.1	#N/A	643.9	#N/A	2.84	#N/A	13	#N/A	#N/A
V32	2000	9/12/2000	#N/A	#N/A	#N/A	#N/A	#N/A	#N/A	#N/A	#N/A	#N/A	#N/A	#N/A	#N/A	#N/A	#N/A	#N/A	#N/A	#N/A	#N/A	#N/A
V32	2001	6/13/2001	#N/A	#N/A	#N/A	11	#N/A	0.324	#N/A	#N/A	#N/A	#N/A	1737	#N/A	1231.8	#N/A	-0.002	#N/A	13	#N/A	#N/A
V32	2001	6/13/2001	#N/A	#N/A	#N/A	#N/A	#N/A	#N/A	#N/A	#N/A	#N/A	#N/A	#N/A	#N/A	#N/A	#N/A	#N/A	#N/A	#N/A	#N/A	#N/A
V32	2001	6/13/2001	#N/A	#N/A	#N/A	#N/A	#N/A	#N/A	#N/A	#N/A	#N/A	#N/A	#N/A	#N/A	#N/A	#N/A	#N/A	#N/A	#N/A	#N/A	#N/A
V32	2003	6/17/2003	#N/A	#N/A	#N/A	5.5	5.4	0.367	0.382	#N/A	#N/A	#N/A	3094.2	3024.6	1994.527	1975.2	0.012	0.012	13.5	13.5	#N/A
V32	2003	6/17/2003	#N/A	#N/A	#N/A	#N/A	#N/A	#N/A	#N/A	#N/A	#N/A	#N/A	#N/A	#N/A	#N/A	#N/A	#N/A	#N/A	#N/A	#N/A	#N/A
V32	2003	9/15/2003	#N/A	#N/A	#N/A	4.1	#N/A	0.437	#N/A	#N/A	#N/A	#N/A	3313.1	#N/A	2145.981	#N/A	0.213	#N/A	14.9	#N/A	#N/A
V32	2003	9/15/2003	#N/A	#N/A	#N/A	#N/A	#N/A	#N/A	#N/A	#N/A	#N/A	#N/A	#N/A	#N/A	#N/A	#N/A	#N/A	#N/A	#N/A	#N/A	#N/A
V32	2004	6/28/2004	#N/A	#N/A	#N/A	1.3	#N/A	#N/A	#N/A	#N/A	0.31	#N/A	3190	#N/A	2340	#N/A	-0.0005	#N/A	7.92	#N/A	7.53
V32	2004	6/28/2004	#N/A	#N/A	#N/A	#N/A	#N/A	#N/A	#N/A	#N/A	#N/A	#N/A	#N/A	#N/A	#N/A	#N/A	#N/A	#N/A	#N/A	#N/A	#N/A
V32	2004	6/28/2004	#N/A	#N/A	#N/A	#N/A	#N/A	#N/A	#N/A	#N/A	#N/A	#N/A	#N/A	#N/A	#N/A	#N/A	#N/A	#N/A	#N/A	#N/A	#N/A
V32	2004	9/20/2004	#N/A	#N/A	#N/A	2.3	#N/A	#N/A	#N/A	#N/A	0.44	#N/A	3960	#N/A	3340	#N/A	-0.0005	#N/A	7.44	#N/A	4.82
V32	2004	9/20/2004	#N/A	#N/A	#N/A	#N/A	#N/A	#N/A	#N/A	#N/A	#N/A	#N/A	#N/A	#N/A	#N/A	#N/A	#N/A	#N/A	#N/A	#N/A	#N/A
V32	2004	9/20/2004	#N/A	#N/A	#N/A	#N/A	#N/A	#N/A	#N/A	#N/A	#N/A	#N/A	#N/A	#N/A	#N/A	#N/A	#N/A	#N/A	#N/A	#N/A	#N/A
V32	2005	6/22/2005	#N/A	#N/A	#N/A	1.4	#N/A	#N/A	#N/A	#N/A	0.47	#N/A	3500	#N/A	3290	#N/A	-0.0005	#N/A	7.77	#N/A	3.53
V32	2005	6/22/2005	#N/A	#N/A	#N/A	#N/A	#N/A	#N/A	#N/A	#N/A	#N/A	#N/A	#N/A	#N/A	#N/A	#N/A	#N/A	#N/A	#N/A	#N/A	#N/A
V32	2005	9/19/2005	#N/A	#N/A	#N/A	1.7	#N/A	#N/A	#N/A	#N/A	0.54	#N/A	4430	#N/A	3500	#N/A	-0.0005	#N/A	7.73	#N/A	3.34
V32	2005	9/19/2005	#N/A	#N/A	#N/A	#N/A	#N/A	#N/A	#N/A	#N/A	#N/A	#N/A	#N/A	#N/A	#N/A	#N/A	#N/A	#N/A	#N/A	#N/A	#N/A
V32	2006	6/8/2006	#N/A	#N/A	#N/A	1.1	#N/A	#N/A	#N/A	#N/A	0.42	#N/A	3310	#N/A	3380	#N/A	0.0011	#N/A	8.53	#N/A	3.55
V32	2006	9/18/2006	#N/A	#N/A	#N/A	1.7	#N/A	#N/A	#N/A	#N/A	0.52	#N/A	4670	#N/A	3550	#N/A	0.208	#N/A	9.8	#N/A	7.1
V32	2007	6/11/2007	#N/A	#N/A	#N/A	2	#N/A	#N/A	#N/A	#N/A	0.54	#N/A	4710	#N/A	3690	#N/A	0.298	#N/A	11.3	#N/A	4.86
V32	2007	10/1/2007	#N/A	#N/A	#N/A	34	#N/A	#N/A	#N/A	#N/A	#N/A	#N/A	5530	#N/A	3860	#N/A	-2	#N/A	18	#N/A	6.61
V32	2008	6/1/2008	#N/A	#N/A	#N/A	1.3	#N/A	#N/A	#N/A	#N/A	0.62	#N/A	5770	#N/A	4310	#N/A	0.555	#N/A	12	#N/A	5.38
V32	2008	9/29/2008	#N/A	#N/A	#N/A	0.6	#N/A	#N/A	#N/A	#N/A	0.88	#N/A	3790	#N/A	2320	#N/A	0.281	#N/A	7	#N/A	2.73

## Drainage Chemistry for Monitoring Location V32, Vangorda Mine Waste Rock Dump

STATION	YEAR	DATE	NI-D mg/L	NI-T mg/L	NO2 mg/L	O2NO3 mg/L	NO3 mg/L	N-T mg/L	PB-D mg/L	PB-T mg/L	P-D mg/L	PH-F pH un	PH-L pH un	PO4 mg/L	P-T mg/L	SB-D mg/L	SB-T mg/L	S-D mg/L	SE-D mg/L	SE-T mg/L	SI-D mg/L	
V32	1988	6/15/1988	#N/A	#N/A	#N/A	#N/A	#N/A	#N/A	#N/A	#N/A	#N/A	#N/A	7.05	#N/A	#N/A	#N/A	#N/A	#N/A	#N/A	#N/A	#N/A	#N/A
V32	1988	7/7/1988	#N/A	#N/A	#N/A	#N/A	#N/A	#N/A	#N/A	#N/A	#N/A	#N/A	7.67	#N/A	#N/A	#N/A	#N/A	#N/A	#N/A	#N/A	#N/A	#N/A
V32	1988	7/11/1988	#N/A	#N/A	#N/A	#N/A	#N/A	#N/A	#N/A	#N/A	#N/A	#N/A	7.25	#N/A	#N/A	#N/A	#N/A	#N/A	#N/A	#N/A	#N/A	#N/A
V32	1988	7/20/1988	#N/A	#N/A	#N/A	#N/A	#N/A	#N/A	#N/A	#N/A	#N/A	#N/A	6.5	#N/A	#N/A	#N/A	#N/A	#N/A	#N/A	#N/A	#N/A	#N/A
V32	1988	7/27/1988	#N/A	#N/A	#N/A	#N/A	#N/A	#N/A	#N/A	#N/A	#N/A	#N/A	7.5	#N/A	#N/A	#N/A	#N/A	#N/A	#N/A	#N/A	#N/A	#N/A
V32	1988	8/24/1988	#N/A	#N/A	#N/A	#N/A	#N/A	#N/A	#N/A	0.005	#N/A	#N/A	8.16	#N/A	#N/A	#N/A	#N/A	#N/A	#N/A	#N/A	#N/A	#N/A
V32	1988	8/24/1988	#N/A	#N/A	#N/A	#N/A	#N/A	#N/A	#N/A	#N/A	#N/A	#N/A	#N/A	#N/A	#N/A	#N/A	#N/A	#N/A	#N/A	#N/A	#N/A	#N/A
V32	1988	9/13/1988	#N/A	#N/A	#N/A	#N/A	#N/A	#N/A	#N/A	0.007	#N/A	#N/A	7.8	#N/A	#N/A	#N/A	#N/A	#N/A	#N/A	#N/A	#N/A	#N/A
V32	1988	9/13/1988	#N/A	#N/A	#N/A	#N/A	#N/A	#N/A	#N/A	#N/A	#N/A	#N/A	#N/A	#N/A	#N/A	#N/A	#N/A	#N/A	#N/A	#N/A	#N/A	#N/A
V32	1988	10/6/1988	#N/A	#N/A	#N/A	#N/A	#N/A	#N/A	#N/A	-0.005	#N/A	#N/A	8	#N/A	#N/A	#N/A	#N/A	#N/A	#N/A	#N/A	#N/A	#N/A
V32	1988	10/6/1988	#N/A	#N/A	#N/A	#N/A	#N/A	#N/A	#N/A	#N/A	#N/A	#N/A	#N/A	#N/A	#N/A	#N/A	#N/A	#N/A	#N/A	#N/A	#N/A	#N/A
V32	1994	8/9/1994	#N/A	10.8	-50	#N/A	-10	#N/A	#N/A	-0.01	#N/A	4.5	4.5	#N/A	-0.06	#N/A	-0.02	#N/A	#N/A	-0.02	#N/A	#N/A
V32	1994	8/9/1994	#N/A	#N/A	#N/A	#N/A	#N/A	#N/A	#N/A	#N/A	#N/A	#N/A	#N/A	#N/A	#N/A	#N/A	#N/A	#N/A	#N/A	#N/A	#N/A	#N/A
V32	1994	8/9/1994	#N/A	#N/A	#N/A	#N/A	#N/A	#N/A	#N/A	#N/A	#N/A	#N/A	#N/A	#N/A	#N/A	#N/A	#N/A	#N/A	#N/A	#N/A	#N/A	#N/A
V32	1994	8/9/1994	#N/A	#N/A	#N/A	#N/A	#N/A	#N/A	#N/A	#N/A	#N/A	#N/A	#N/A	#N/A	#N/A	#N/A	#N/A	#N/A	#N/A	#N/A	#N/A	#N/A
V32	1994	8/9/1994	#N/A	#N/A	#N/A	#N/A	#N/A	#N/A	#N/A	#N/A	#N/A	#N/A	#N/A	#N/A	#N/A	#N/A	#N/A	#N/A	#N/A	#N/A	#N/A	#N/A
V32	1995	5/9/1995	#N/A	6.57	-50	#N/A	-5	#N/A	#N/A	0.23	#N/A	5.5	3.8	#N/A	-0.06	#N/A	-0.02	#N/A	#N/A	-0.02	#N/A	#N/A
V32	1995	5/9/1995	#N/A	#N/A	#N/A	#N/A	#N/A	#N/A	#N/A	#N/A	#N/A	#N/A	#N/A	#N/A	#N/A	#N/A	#N/A	#N/A	#N/A	#N/A	#N/A	#N/A
V32	1995	5/9/1995	#N/A	#N/A	#N/A	#N/A	#N/A	#N/A	#N/A	#N/A	#N/A	#N/A	#N/A	#N/A	#N/A	#N/A	#N/A	#N/A	#N/A	#N/A	#N/A	#N/A
V32	1995	5/9/1995	#N/A	#N/A	#N/A	#N/A	#N/A	#N/A	#N/A	#N/A	#N/A	#N/A	#N/A	#N/A	#N/A	#N/A	#N/A	#N/A	#N/A	#N/A	#N/A	#N/A
V32	1996	5/27/1996	3.59	#N/A	#N/A	#N/A	#N/A	#N/A	-0.2	#N/A	0.9	5	#N/A	#N/A	#N/A	0.8	#N/A	#N/A	#N/A	#N/A	#N/A	4.4
V32	1996	5/27/1996	#N/A	#N/A	#N/A	#N/A	#N/A	#N/A	#N/A	#N/A	#N/A	#N/A	#N/A	#N/A	#N/A	#N/A	#N/A	#N/A	#N/A	#N/A	#N/A	#N/A
V32	1996	9/11/1996	4.42	#N/A	#N/A	#N/A	#N/A	#N/A	0.6	#N/A	0.6	5.34	#N/A	#N/A	#N/A	1.1	#N/A	#N/A	#N/A	#N/A	#N/A	11.5
V32	1996	9/11/1996	#N/A	#N/A	#N/A	#N/A	#N/A	#N/A	#N/A	#N/A	#N/A	#N/A	#N/A	#N/A	#N/A	#N/A	#N/A	#N/A	#N/A	#N/A	#N/A	#N/A
V32	1996	9/11/1996	#N/A	#N/A	#N/A	#N/A	#N/A	#N/A	#N/A	#N/A	#N/A	#N/A	#N/A	#N/A	#N/A	#N/A	#N/A	#N/A	#N/A	#N/A	#N/A	#N/A
V32	1997	5/12/1997	#N/A	3.261	#N/A	#N/A	#N/A	#N/A	#N/A	0.32	#N/A	5.22	#N/A	#N/A	2.08	#N/A	1.13	#N/A	#N/A	-0.03	#N/A	#N/A
V32	1997	5/12/1997	#N/A	#N/A	#N/A	#N/A	#N/A	#N/A	#N/A	#N/A	#N/A	#N/A	#N/A	#N/A	#N/A	#N/A	#N/A	#N/A	#N/A	#N/A	#N/A	#N/A
V32	1997	5/12/1997	#N/A	#N/A	#N/A	#N/A	#N/A	#N/A	#N/A	#N/A	#N/A	#N/A	#N/A	#N/A	#N/A	#N/A	#N/A	#N/A	#N/A	#N/A	#N/A	#N/A
V32	1997	6/30/1997	6.346	6.399	#N/A	#N/A	#N/A	#N/A	4.17	4.24	96.23	4.08	#N/A	#N/A	97.54	3.2	3.19	#N/A	-0.03	-0.03	13.4	#N/A
V32	1997	6/30/1997	#N/A	#N/A	#N/A	#N/A	#N/A	#N/A	#N/A	#N/A	#N/A	#N/A	#N/A	#N/A	#N/A	#N/A	#N/A	#N/A	#N/A	#N/A	#N/A	#N/A
V32	1997	7/22/1997	7.7	#N/A	#N/A	#N/A	#N/A	#N/A	8.9	#N/A	168.6	3.91	#N/A	#N/A	#N/A	4.8	#N/A	#N/A	-0.03	#N/A	21.2	#N/A
V32	1997	7/22/1997	#N/A	#N/A	#N/A	#N/A	#N/A	#N/A	#N/A	#N/A	#N/A	#N/A	#N/A	#N/A	#N/A	#N/A	#N/A	#N/A	#N/A	#N/A	#N/A	#N/A
V32	1997	7/22/1997	#N/A	#N/A	#N/A	#N/A	#N/A	#N/A	#N/A	#N/A	#N/A	#N/A	#N/A	#N/A	#N/A	#N/A	#N/A	#N/A	#N/A	#N/A	#N/A	#N/A
V32	1997	8/6/1997	#N/A	#N/A	#N/A	#N/A	#N/A	#N/A	#N/A	#N/A	#N/A	#N/A	#N/A	#N/A	#N/A	#N/A	#N/A	#N/A	#N/A	#N/A	#N/A	#N/A
V32	1997	8/11/1997	#N/A	6.411	#N/A	#N/A	#N/A	#N/A	#N/A	4.46	#N/A	4.14	#N/A	#N/A	97.02	#N/A	3.14	#N/A	#N/A	-0.03	#N/A	#N/A
V32	1997	8/11/1997	#N/A	#N/A	#N/A	#N/A	#N/A	#N/A	#N/A	#N/A	#N/A	#N/A	#N/A	#N/A	#N/A	#N/A	#N/A	#N/A	#N/A	#N/A	#N/A	#N/A
V32	1997	8/11/1997	6.053	#N/A	#N/A	#N/A	#N/A	#N/A	4.22	#N/A	93.1	#N/A	#N/A	#N/A	#N/A	2.82	#N/A	#N/A	-0.03	#N/A	11.5	#N/A
V32	1997	9/30/1997	#N/A	#N/A	#N/A	#N/A	#N/A	#N/A	#N/A	#N/A	#N/A	3.7	#N/A	#N/A	#N/A	#N/A	#N/A	#N/A	#N/A	#N/A	#N/A	#N/A
V32	1997	9/30/1997	#N/A	#N/A	#N/A	#N/A	#N/A	#N/A	#N/A	#N/A	#N/A	#N/A	#N/A	#N/A	#N/A	#N/A	#N/A	#N/A	#N/A	#N/A	#N/A	#N/A
V32	1997	9/30/1997	#N/A	6.931	#N/A	#N/A	#N/A	#N/A	#N/A	6.98	#N/A	#N/A	#N/A	#N/A	148.74	#N/A	7.8	#N/A	#N/A	-0.03	#N/A	#N/A
V32	1997	9/30/1997	7.024	#N/A	#N/A	#N/A	#N/A	#N/A	7.37	#N/A	141.82	#N/A	#N/A	#N/A	#N/A	8.1	#N/A	#N/A	-0.03	#N/A	14.4	#N/A
V32	1997	10/20/1997	7.673	#N/A	#N/A	#N/A	#N/A	#N/A	0.95	#N/A	3.57	4.21	#N/A	#N/A	#N/A	3.06	#N/A	#N/A	1.25	#N/A	19.5	#N/A
V32	1997	10/20/1997	#N/A	#N/A	#N/A	#N/A	#N/A	#N/A	#N/A	#N/A	#N/A	#N/A	#N/A	#N/A	#N/A	#N/A	#N/A	#N/A	#N/A	#N/A	#N/A	#N/A
V32	1997	10/20/1997	#N/A	#N/A	#N/A	#N/A	#N/A	#N/A	#N/A	#N/A	#N/A	#N/A	#N/A	#N/A	#N/A	#N/A	#N/A	#N/A	#N/A	#N/A	#N/A	#N/A
V32	1997	12/22/1997	7.656	#N/A	#N/A	#N/A	#N/A	#N/A	0.34	#N/A	10.88	4.31	#N/A	#N/A	#N/A	1.66	#N/A	#N/A	0.095	#N/A	17.2	#N/A
V32	1997	12/22/1997	#N/A	#N/A	#N/A	#N/A	#N/A	#N/A	#N/A	#N/A	#N/A	#N/A	#N/A	#N/A	#N/A	#N/A	#N/A	#N/A	#N/A	#N/A	#N/A	#N/A
V32	1998	5/18/1998	4.182	#N/A	#N/A	#N/A	#N/A	#N/A	3.65	#N/A	82.5	4.7	#N/A	#N/A	#N/A	2.51	#N/A	#N/A	-0.03	#N/A	9.7	#N/A
V32	1998	5/18/1998	#N/A	#N/A	#N/A	#N/A	#N/A	#N/A	#N/A	#N/A	#N/A	#N/A	#N/A	#N/A	#N/A	#N/A	#N/A	#N/A	#N/A	#N/A	#N/A	#N/A
V32	1998	6/29/1998	8.551	#N/A	#N/A	#N/A	#N/A	#N/A	11.82	#N/A	291.97	3.37	#N/A	#N/A	#N/A	6.18	#N/A	#N/A	-0.03	#N/A	17	#N/A
V32	1998	6/29/1998	#N/A	#N/A	#N/A	#N/A	#N/A	#N/A	#N/A	#N/A	#N/A	#N/A	#N/A	#N/A	#N/A	#N/A	#N/A	#N/A	#N/A	#N/A	#N/A	#N/A
V32	1998	6/29/1998	#N/A	#N/A	#N/A	#N/A	#N/A	#N/A	#N/A	#N/A	#N/A	#N/A	#N/A	#N/A	#N/A	#N/A	#N/A	#N/A	#N/A	#N/A	#N/A	#N/A
V32	1998	9/14/1998	10.116	#N/A	#N/A	#N/A	#N/A	#N/A	11.22	#N/A	240.05	3.51	#N/A	#N/A	#N/A	7.67	#N/A	#N/A	-0.03	#N/A	16.5	#N/A
V32	1998	9/14/1998	#N/A	#N/A	#N/A	#N/A	#N/A	#N/A	#N/A	#N/A	#N/A	#N/A	#N/A	#N/A	#N/A	#N/A	#N/A	#N/A	#N/A	#N/A	#N/A	#N/A
V32	1998	9/14/1998	#N/A	#N/A	#N/A	#N/A	#N/A	#N/A	#N/A	#N/A	#N/A	#N/A	#N/A	#N/A	#N/A	#N/A	#N/A	#N/A	#N/A	#N/A	#N/A	#N/A

## Drainage Chemistry for Monitoring Location V32, Vangorda Mine Waste Rock Dump

STATION	YEAR	DATE	NI-D mg/L	NI-T mg/L	NO2 mg/L	O2NO3 mg	NO3 mg/L	N-T mg/L	PB-D mg/L	PB-T mg/L	P-D mg/L	PH-F pH un	PH-L pH un	PO4 mg/L	P-T mg/L	SB-D mg/L	SB-T mg/L	S-D mg/L	SE-D mg/L	SE-T mg/L	SI-D mg/L
V32	1999	5/18/1999	5.943	#N/A	#N/A	#N/A	#N/A	#N/A	4.99	#N/A	119.64	5.82	#N/A	#N/A	#N/A	1.49	#N/A	#N/A	-0.03	#N/A	9.3
V32	1999	5/18/1999	#N/A	#N/A	#N/A	#N/A	#N/A	#N/A	#N/A	#N/A	#N/A	#N/A	#N/A	#N/A	#N/A	#N/A	#N/A	#N/A	#N/A	#N/A	#N/A
V32	1999	6/18/1999	7.451	#N/A	#N/A	#N/A	#N/A	#N/A	9.6	#N/A	257.07	4.61	#N/A	#N/A	#N/A	9.06	#N/A	#N/A	-0.03	#N/A	11.5
V32	1999	6/18/1999	#N/A	#N/A	#N/A	#N/A	#N/A	#N/A	#N/A	#N/A	#N/A	#N/A	#N/A	#N/A	#N/A	#N/A	#N/A	#N/A	#N/A	#N/A	#N/A
V32	1999	8/12/1999	11.64	#N/A	#N/A	#N/A	#N/A	#N/A	6.8	#N/A	18.9	4.81	#N/A	#N/A	#N/A	#N/A	#N/A	#N/A	-0.005	#N/A	28.7
V32	1999	8/12/1999	#N/A	#N/A	#N/A	#N/A	#N/A	#N/A	#N/A	#N/A	#N/A	#N/A	#N/A	#N/A	#N/A	#N/A	#N/A	#N/A	#N/A	#N/A	#N/A
V32	1999	8/12/1999	#N/A	#N/A	#N/A	#N/A	#N/A	#N/A	#N/A	#N/A	#N/A	#N/A	#N/A	#N/A	#N/A	#N/A	#N/A	#N/A	#N/A	#N/A	#N/A
V32	1999	10/12/1999	9.756	#N/A	#N/A	#N/A	#N/A	#N/A	4.71	#N/A	19.38	3.04	#N/A	#N/A	#N/A	5.26	#N/A	#N/A	-0.005	#N/A	12.2
V32	1999	10/12/1999	#N/A	#N/A	#N/A	#N/A	#N/A	#N/A	#N/A	#N/A	#N/A	#N/A	#N/A	#N/A	#N/A	#N/A	#N/A	#N/A	#N/A	#N/A	#N/A
V32	1999	10/12/1999	#N/A	#N/A	#N/A	#N/A	#N/A	#N/A	#N/A	#N/A	#N/A	#N/A	#N/A	#N/A	#N/A	#N/A	#N/A	#N/A	#N/A	#N/A	#N/A
V32	1999	12/13/1999	9.578	#N/A	#N/A	#N/A	#N/A	#N/A	1.62	#N/A	9.11	3.98	#N/A	#N/A	#N/A	5.52	#N/A	#N/A	-0.005	#N/A	19.5
V32	1999	12/13/1999	#N/A	#N/A	#N/A	#N/A	#N/A	#N/A	#N/A	#N/A	#N/A	#N/A	#N/A	#N/A	#N/A	#N/A	#N/A	#N/A	#N/A	#N/A	#N/A
V32	1999	12/13/1999	#N/A	#N/A	#N/A	#N/A	#N/A	#N/A	#N/A	#N/A	#N/A	#N/A	#N/A	#N/A	#N/A	#N/A	#N/A	#N/A	#N/A	#N/A	#N/A
V32	2000	5/31/2000	8.023	#N/A	#N/A	#N/A	#N/A	#N/A	6.49	#N/A	18	3.55	#N/A	#N/A	#N/A	-0.03	#N/A	#N/A	-0.005	#N/A	16.7
V32	2000	5/31/2000	#N/A	#N/A	#N/A	#N/A	#N/A	#N/A	#N/A	#N/A	#N/A	#N/A	#N/A	#N/A	#N/A	#N/A	#N/A	#N/A	#N/A	#N/A	#N/A
V32	2000	5/31/2000	#N/A	#N/A	#N/A	#N/A	#N/A	#N/A	#N/A	#N/A	#N/A	#N/A	#N/A	#N/A	#N/A	#N/A	#N/A	#N/A	#N/A	#N/A	#N/A
V32	2000	9/12/2000	7.6	#N/A	#N/A	#N/A	#N/A	#N/A	6.14	#N/A	304	3.81	#N/A	#N/A	#N/A	6.29	#N/A	#N/A	-0.005	#N/A	13.7
V32	2000	9/12/2000	#N/A	#N/A	#N/A	#N/A	#N/A	#N/A	#N/A	#N/A	#N/A	#N/A	#N/A	#N/A	#N/A	#N/A	#N/A	#N/A	#N/A	#N/A	#N/A
V32	2001	6/13/2001	8.436	#N/A	#N/A	#N/A	#N/A	#N/A	1.49	#N/A	-1	3.6	#N/A	#N/A	#N/A	-0.03	#N/A	#N/A	0.93	#N/A	16.4
V32	2001	6/13/2001	#N/A	#N/A	#N/A	#N/A	#N/A	#N/A	#N/A	#N/A	#N/A	#N/A	#N/A	#N/A	#N/A	#N/A	#N/A	#N/A	#N/A	#N/A	#N/A
V32	2001	6/13/2001	#N/A	#N/A	#N/A	#N/A	#N/A	#N/A	#N/A	#N/A	#N/A	#N/A	#N/A	#N/A	#N/A	#N/A	#N/A	#N/A	#N/A	#N/A	#N/A
V32	2003	6/17/2003	13.049	12.834	#N/A	#N/A	#N/A	#N/A	0.272	0.27	-0.01	#N/A	#N/A	#N/A	-0.01	-0.002	-0.002	#N/A	#N/A	3.346	#N/A
V32	2003	6/17/2003	#N/A	#N/A	#N/A	#N/A	#N/A	#N/A	#N/A	#N/A	#N/A	#N/A	#N/A	#N/A	#N/A	#N/A	#N/A	#N/A	#N/A	3.287	#N/A
V32	2003	9/15/2003	13.094	#N/A	#N/A	#N/A	#N/A	#N/A	0.682	#N/A	-0.01	2.8	#N/A	#N/A	#N/A	-0.002	#N/A	#N/A	1.231	#N/A	#N/A
V32	2003	9/15/2003	#N/A	#N/A	#N/A	#N/A	#N/A	#N/A	#N/A	#N/A	#N/A	#N/A	#N/A	#N/A	#N/A	#N/A	#N/A	#N/A	#N/A	#N/A	#N/A
V32	2004	6/28/2004	19.8	#N/A	#N/A	#N/A	#N/A	#N/A	#N/A	#N/A	0.2	2.2	#N/A	#N/A	#N/A	-0.001	#N/A	#N/A	0.18	#N/A	#N/A
V32	2004	6/28/2004	#N/A	#N/A	#N/A	#N/A	#N/A	#N/A	#N/A	#N/A	#N/A	#N/A	#N/A	#N/A	#N/A	#N/A	#N/A	#N/A	#N/A	#N/A	#N/A
V32	2004	6/28/2004	#N/A	#N/A	#N/A	#N/A	#N/A	#N/A	0.11	#N/A	#N/A	#N/A	#N/A	#N/A	#N/A	#N/A	#N/A	#N/A	#N/A	#N/A	53.7
V32	2004	9/20/2004	#N/A	#N/A	#N/A	#N/A	#N/A	#N/A	0.84	#N/A	-0.15	3.2	#N/A	#N/A	#N/A	0.002	#N/A	#N/A	0.13	#N/A	41.2
V32	2004	9/20/2004	#N/A	#N/A	#N/A	#N/A	#N/A	#N/A	#N/A	#N/A	#N/A	#N/A	#N/A	#N/A	#N/A	#N/A	#N/A	#N/A	#N/A	#N/A	#N/A
V32	2004	9/20/2004	23.2	#N/A	#N/A	#N/A	#N/A	#N/A	#N/A	#N/A	#N/A	#N/A	#N/A	#N/A	#N/A	#N/A	#N/A	#N/A	#N/A	#N/A	#N/A
V32	2005	6/22/2005	14.1	#N/A	#N/A	#N/A	#N/A	#N/A	0.54	#N/A	-0.15	3.2	#N/A	#N/A	#N/A	0.002	#N/A	#N/A	0.1	#N/A	36.9
V32	2005	6/22/2005	#N/A	#N/A	#N/A	#N/A	#N/A	#N/A	#N/A	#N/A	#N/A	#N/A	#N/A	#N/A	#N/A	#N/A	#N/A	#N/A	#N/A	#N/A	#N/A
V32	2005	9/19/2005	22.3	#N/A	#N/A	#N/A	#N/A	#N/A	0.52	#N/A	-0.15	3.3	#N/A	#N/A	#N/A	0.001	#N/A	#N/A	0.12	#N/A	33.2
V32	2005	9/19/2005	#N/A	#N/A	#N/A	#N/A	#N/A	#N/A	#N/A	#N/A	#N/A	#N/A	#N/A	#N/A	#N/A	#N/A	#N/A	#N/A	#N/A	#N/A	#N/A
V32	2006	6/8/2006	14.1	#N/A	#N/A	#N/A	#N/A	#N/A	0.69	#N/A	-0.15	3.5	#N/A	#N/A	#N/A	0.001	#N/A	#N/A	0.077	#N/A	20.3
V32	2006	9/18/2006	11.3	#N/A	#N/A	#N/A	#N/A	#N/A	0.55	#N/A	-0.15	3.1	#N/A	#N/A	#N/A	0.001	#N/A	#N/A	0.094	#N/A	15.9
V32	2007	6/11/2007	12.8	#N/A	#N/A	#N/A	#N/A	#N/A	1.2	#N/A	-0.15	2.9	#N/A	#N/A	#N/A	0.001	#N/A	#N/A	0.072	#N/A	16.9
V32	2007	10/1/2007	19	#N/A	#N/A	#N/A	#N/A	#N/A	#N/A	#N/A	-15	3.1	#N/A	#N/A	#N/A	#N/A	#N/A	#N/A	#N/A	#N/A	22
V32	2008	6/1/2008	15	#N/A	#N/A	#N/A	#N/A	#N/A	0.35	#N/A	-0.15	2.7	#N/A	#N/A	#N/A	0.001	#N/A	#N/A	0.11	#N/A	16
V32	2008	9/29/2008	16.7	#N/A	#N/A	#N/A	#N/A	#N/A	1	#N/A	-0.15	3.7	#N/A	#N/A	#N/A	0.002	#N/A	#N/A	0.074	#N/A	13

## Drainage Chemistry for Monitoring Location V32, Vangorda Mine Waste Rock Dump

STATION	YEAR	DATE	SI-T mg/L	SN-D mg/L	SN-T mg/L	SO4 mg/L	SR-D mg/L	SR-T mg/L	S-T mg/L	SWEL m	TDS mg/L	TE-D mg/L	TEMP-F °C	TEMP-L °C	TE-T mg/L	TH-D mg/L	TH-T mg/L	TI-D mg/L	TI-T mg/L	TKN mg/L	TL-D mg/L		
V32	1988	6/15/1988	#N/A	#N/A	#N/A	#N/A	#N/A	#N/A	#N/A	#N/A	#N/A	#N/A	14	#N/A	#N/A	#N/A	#N/A	#N/A	#N/A	#N/A	#N/A	#N/A	
V32	1988	7/7/1988	#N/A	#N/A	#N/A	#N/A	#N/A	#N/A	#N/A	#N/A	#N/A	#N/A	9	#N/A	#N/A	#N/A	#N/A	#N/A	#N/A	#N/A	#N/A	#N/A	
V32	1988	7/11/1988	#N/A	#N/A	#N/A	#N/A	#N/A	#N/A	#N/A	#N/A	#N/A	#N/A	#N/A	#N/A	#N/A	#N/A	#N/A	#N/A	#N/A	#N/A	#N/A	#N/A	
V32	1988	7/20/1988	#N/A	#N/A	#N/A	#N/A	#N/A	#N/A	#N/A	#N/A	#N/A	#N/A	#N/A	#N/A	#N/A	#N/A	#N/A	#N/A	#N/A	#N/A	#N/A	#N/A	
V32	1988	7/27/1988	#N/A	#N/A	#N/A	#N/A	#N/A	#N/A	#N/A	#N/A	#N/A	#N/A	8	#N/A	#N/A	#N/A	#N/A	#N/A	#N/A	#N/A	#N/A	#N/A	
V32	1988	8/24/1988	#N/A	#N/A	#N/A	#N/A	#N/A	#N/A	#N/A	#N/A	#N/A	#N/A	5	#N/A	#N/A	#N/A	#N/A	#N/A	#N/A	#N/A	#N/A	#N/A	
V32	1988	8/24/1988	#N/A	#N/A	#N/A	-1	#N/A	#N/A	#N/A	#N/A	#N/A	#N/A	#N/A	#N/A	#N/A	#N/A	#N/A	#N/A	#N/A	#N/A	#N/A	#N/A	
V32	1988	9/13/1988	#N/A	#N/A	#N/A	#N/A	#N/A	#N/A	#N/A	#N/A	#N/A	#N/A	3	#N/A	#N/A	#N/A	#N/A	#N/A	#N/A	#N/A	#N/A	#N/A	
V32	1988	9/13/1988	#N/A	#N/A	#N/A	-1	#N/A	#N/A	#N/A	#N/A	#N/A	#N/A	#N/A	#N/A	#N/A	#N/A	#N/A	#N/A	#N/A	#N/A	#N/A	#N/A	
V32	1988	10/6/1988	#N/A	#N/A	#N/A	#N/A	#N/A	#N/A	#N/A	#N/A	#N/A	#N/A	8	#N/A	#N/A	#N/A	#N/A	#N/A	#N/A	#N/A	#N/A	#N/A	
V32	1988	10/6/1988	#N/A	#N/A	#N/A	-1	#N/A	#N/A	#N/A	#N/A	#N/A	#N/A	#N/A	#N/A	#N/A	#N/A	#N/A	#N/A	#N/A	#N/A	#N/A	#N/A	
V32	1994	8/9/1994	7.39	#N/A	-0.01	#N/A	#N/A	0.78	2060	#N/A	8080	#N/A	#N/A	21.6	#N/A	#N/A	#N/A	#N/A	#N/A	-0.001	#N/A	#N/A	
V32	1994	8/9/1994	#N/A	#N/A	#N/A	#N/A	#N/A	#N/A	#N/A	#N/A	#N/A	#N/A	#N/A	#N/A	#N/A	#N/A	#N/A	#N/A	#N/A	#N/A	#N/A	#N/A	
V32	1994	8/9/1994	#N/A	#N/A	#N/A	6390	#N/A	#N/A	#N/A	#N/A	#N/A	#N/A	#N/A	#N/A	#N/A	#N/A	#N/A	#N/A	#N/A	#N/A	#N/A	#N/A	
V32	1994	8/9/1994	#N/A	#N/A	#N/A	#N/A	#N/A	#N/A	#N/A	#N/A	#N/A	#N/A	#N/A	#N/A	#N/A	#N/A	#N/A	#N/A	#N/A	#N/A	#N/A	#N/A	
V32	1994	8/9/1994	#N/A	#N/A	#N/A	#N/A	#N/A	#N/A	#N/A	#N/A	#N/A	#N/A	#N/A	#N/A	#N/A	#N/A	#N/A	#N/A	#N/A	#N/A	#N/A	#N/A	
V32	1995	5/9/1995	9.94	#N/A	0.02	#N/A	#N/A	0.64	1890	#N/A	10100	#N/A	#N/A	13.6	#N/A	#N/A	#N/A	#N/A	#N/A	0.01	#N/A	#N/A	
V32	1995	5/9/1995	#N/A	#N/A	#N/A	#N/A	#N/A	#N/A	#N/A	#N/A	#N/A	#N/A	#N/A	#N/A	#N/A	#N/A	#N/A	#N/A	#N/A	#N/A	#N/A	#N/A	
V32	1995	5/9/1995	#N/A	#N/A	#N/A	7110	#N/A	#N/A	#N/A	#N/A	#N/A	#N/A	#N/A	#N/A	#N/A	#N/A	#N/A	#N/A	#N/A	#N/A	#N/A	#N/A	
V32	1995	5/9/1995	#N/A	#N/A	#N/A	#N/A	#N/A	#N/A	#N/A	#N/A	#N/A	#N/A	#N/A	#N/A	#N/A	#N/A	#N/A	#N/A	#N/A	#N/A	#N/A	#N/A	
V32	1996	5/27/1996	#N/A	#N/A	#N/A	#N/A	0.69	#N/A	#N/A	#N/A	1470	#N/A	#N/A	9	#N/A	#N/A	#N/A	#N/A	#N/A	-0.05	#N/A	#N/A	
V32	1996	5/27/1996	#N/A	#N/A	#N/A	3775	#N/A	#N/A	#N/A	#N/A	#N/A	#N/A	#N/A	#N/A	#N/A	#N/A	#N/A	#N/A	#N/A	#N/A	#N/A	#N/A	
V32	1996	9/11/1996	#N/A	#N/A	#N/A	#N/A	1.06	#N/A	#N/A	#N/A	#N/A	#N/A	#N/A	9	#N/A	#N/A	#N/A	#N/A	#N/A	-0.05	#N/A	#N/A	
V32	1996	9/11/1996	#N/A	#N/A	#N/A	5459	#N/A	#N/A	#N/A	#N/A	#N/A	#N/A	#N/A	#N/A	#N/A	#N/A	#N/A	#N/A	#N/A	#N/A	#N/A	#N/A	
V32	1996	9/11/1996	#N/A	#N/A	#N/A	#N/A	#N/A	#N/A	#N/A	#N/A	#N/A	#N/A	#N/A	#N/A	#N/A	#N/A	#N/A	#N/A	#N/A	#N/A	#N/A	#N/A	
V32	1997	5/12/1997	10.4	#N/A	0.14	#N/A	#N/A	0.664	1250	#N/A	#N/A	#N/A	#N/A	4.5	#N/A	#N/A	#N/A	#N/A	#N/A	0.034	#N/A	#N/A	
V32	1997	5/12/1997	#N/A	#N/A	#N/A	3689	#N/A	#N/A	#N/A	#N/A	#N/A	#N/A	#N/A	#N/A	#N/A	#N/A	#N/A	#N/A	#N/A	#N/A	#N/A	#N/A	
V32	1997	5/12/1997	#N/A	#N/A	#N/A	#N/A	#N/A	#N/A	#N/A	#N/A	#N/A	#N/A	#N/A	#N/A	#N/A	#N/A	#N/A	#N/A	#N/A	#N/A	#N/A	#N/A	
V32	1997	6/30/1997	13.8	-0.01	-0.01	#N/A	1.006	1.048	1074	#N/A	#N/A	#N/A	#N/A	19.6	#N/A	#N/A	#N/A	#N/A	#N/A	0.03	0.033	#N/A	#N/A
V32	1997	6/30/1997	#N/A	#N/A	#N/A	3319	#N/A	#N/A	#N/A	#N/A	#N/A	#N/A	#N/A	#N/A	#N/A	#N/A	#N/A	#N/A	#N/A	#N/A	#N/A	#N/A	
V32	1997	7/22/1997	#N/A	-0.01	#N/A	#N/A	1.2	#N/A	#N/A	#N/A	#N/A	#N/A	#N/A	12.1	#N/A	#N/A	#N/A	#N/A	#N/A	0.3	#N/A	#N/A	
V32	1997	7/22/1997	#N/A	#N/A	#N/A	3868	#N/A	#N/A	#N/A	#N/A	#N/A	#N/A	#N/A	#N/A	#N/A	#N/A	#N/A	#N/A	#N/A	#N/A	#N/A	#N/A	
V32	1997	7/22/1997	#N/A	#N/A	#N/A	#N/A	#N/A	#N/A	#N/A	#N/A	#N/A	#N/A	#N/A	#N/A	#N/A	#N/A	#N/A	#N/A	#N/A	#N/A	#N/A	#N/A	
V32	1997	8/6/1997	#N/A	#N/A	#N/A	#N/A	#N/A	#N/A	#N/A	#N/A	#N/A	#N/A	#N/A	#N/A	#N/A	#N/A	#N/A	#N/A	#N/A	#N/A	#N/A	#N/A	
V32	1997	8/11/1997	13.4	#N/A	-0.01	#N/A	#N/A	0.952	1315	#N/A	#N/A	#N/A	#N/A	15.8	#N/A	#N/A	#N/A	#N/A	#N/A	0.029	#N/A	#N/A	
V32	1997	8/11/1997	#N/A	#N/A	#N/A	3944	#N/A	#N/A	#N/A	#N/A	#N/A	#N/A	#N/A	#N/A	#N/A	#N/A	#N/A	#N/A	#N/A	#N/A	#N/A	#N/A	
V32	1997	8/11/1997	#N/A	-0.01	#N/A	#N/A	0.876	#N/A	#N/A	#N/A	#N/A	#N/A	#N/A	#N/A	#N/A	#N/A	#N/A	#N/A	#N/A	0.026	#N/A	#N/A	
V32	1997	9/30/1997	#N/A	#N/A	#N/A	#N/A	#N/A	#N/A	#N/A	#N/A	#N/A	#N/A	#N/A	5.2	#N/A	#N/A	#N/A	#N/A	#N/A	#N/A	#N/A	#N/A	
V32	1997	9/30/1997	#N/A	#N/A	#N/A	10493	#N/A	#N/A	#N/A	#N/A	#N/A	#N/A	#N/A	#N/A	#N/A	#N/A	#N/A	#N/A	#N/A	#N/A	#N/A	#N/A	
V32	1997	9/30/1997	14.8	#N/A	-0.01	#N/A	#N/A	0.811	3498	#N/A	#N/A	#N/A	#N/A	#N/A	#N/A	#N/A	#N/A	#N/A	#N/A	0.059	#N/A	#N/A	
V32	1997	9/30/1997	#N/A	-0.01	#N/A	#N/A	0.84	#N/A	#N/A	#N/A	#N/A	#N/A	#N/A	#N/A	#N/A	#N/A	#N/A	#N/A	#N/A	0.053	#N/A	#N/A	
V32	1997	10/20/1997	#N/A	#N/A	#N/A	#N/A	1.094	#N/A	#N/A	#N/A	#N/A	#N/A	#N/A	2.1	#N/A	#N/A	#N/A	#N/A	#N/A	0.025	#N/A	#N/A	
V32	1997	10/20/1997	#N/A	#N/A	#N/A	9267	#N/A	#N/A	#N/A	#N/A	#N/A	#N/A	#N/A	#N/A	#N/A	#N/A	#N/A	#N/A	#N/A	#N/A	#N/A	#N/A	
V32	1997	10/20/1997	#N/A	0.1	#N/A	#N/A	#N/A	#N/A	#N/A	#N/A	#N/A	#N/A	#N/A	#N/A	#N/A	#N/A	#N/A	#N/A	#N/A	#N/A	#N/A	#N/A	
V32	1997	12/22/1997	#N/A	0.06	#N/A	#N/A	0.941	#N/A	#N/A	#N/A	#N/A	#N/A	#N/A	#N/A	#N/A	#N/A	#N/A	#N/A	#N/A	-0.005	#N/A	#N/A	
V32	1997	12/22/1997	#N/A	#N/A	#N/A	8558	#N/A	#N/A	#N/A	#N/A	#N/A	#N/A	#N/A	#N/A	#N/A	#N/A	#N/A	#N/A	#N/A	#N/A	#N/A	#N/A	
V32	1998	5/18/1998	#N/A	-0.01	#N/A	#N/A	0.607	#N/A	#N/A	#N/A	#N/A	#N/A	#N/A	#N/A	#N/A	#N/A	#N/A	#N/A	#N/A	0.081	#N/A	#N/A	
V32	1998	5/18/1998	#N/A	#N/A	#N/A	3003	#N/A	#N/A	#N/A	#N/A	#N/A	#N/A	#N/A	#N/A	#N/A	#N/A	#N/A	#N/A	#N/A	#N/A	#N/A	#N/A	
V32	1998	6/29/1998	#N/A	-0.01	#N/A	#N/A	1.012	#N/A	#N/A	#N/A	#N/A	#N/A	#N/A	#N/A	#N/A	#N/A	#N/A	#N/A	#N/A	0.112	#N/A	#N/A	
V32	1998	6/29/1998	#N/A	#N/A	#N/A	3961	#N/A	#N/A	#N/A	#N/A	#N/A	#N/A	#N/A	#N/A	#N/A	#N/A	#N/A	#N/A	#N/A	#N/A	#N/A	#N/A	
V32	1998	6/29/1998	#N/A	#N/A	#N/A	#N/A	#N/A	#N/A	#N/A	#N/A	#N/A	#N/A	#N/A	#N/A	#N/A	#N/A	#N/A	#N/A	#N/A	#N/A	#N/A	#N/A	
V32	1998	9/14/1998	#N/A	-0.01	#N/A	#N/A	0.907	#N/A	#N/A	#N/A	#N/A	#N/A	#N/A	2	#N/A	#N/A	#N/A	#N/A	#N/A	0.018	#N/A	#N/A	
V32	1998	9/14/1998	#N/A	#N/A	#N/A	10947	#N/A	#N/A	#N/A	#N/A	#N/A	#N/A	#N/A	#N/A	#N/A	#N/A	#N/A	#N/A	#N/A	#N/A	#N/A	#N/A	
V32	1998	9/14/1998	#N/A	#N/A	#N/A	#N/A	#N/A	#N/A	#N/A	#N/A	#N/A	#N/A	#N/A	#N/A	#N/A	#N/A	#N/A	#N/A	#N/A	#N/A	#N/A	#N/A	



## Drainage Chemistry for Monitoring Location V32, Vangorda Mine Waste Rock Dump

STATION	YEAR	DATE	SI-T mg/L	SN-D mg/L	SN-T mg/L	SO4 mg/L	SR-D mg/L	SR-T mg/L	S-T mg/L	SWEL m	TDS mg/L	TE-D mg/L	TEMP-F °C	TEMP-L °C	TE-T mg/L	TH-D mg/L	TH-T mg/L	TI-D mg/L	TI-T mg/L	TKN mg/L	TL-D mg/L	
V32	1999	5/18/1999	#N/A	-0.01	#N/A	#N/A	0.688	#N/A	#N/A	#N/A	#N/A	#N/A	#N/A	#N/A	#N/A	#N/A	#N/A	0.022	#N/A	#N/A	#N/A	
V32	1999	5/18/1999	#N/A	#N/A	#N/A	9365	#N/A	#N/A	#N/A	#N/A	#N/A	#N/A	#N/A	#N/A	#N/A	#N/A	#N/A	#N/A	#N/A	#N/A	#N/A	
V32	1999	6/18/1999	#N/A	-0.01	#N/A	#N/A	1.029	#N/A	#N/A	#N/A	#N/A	#N/A	#N/A	#N/A	12	#N/A	#N/A	#N/A	-0.005	#N/A	#N/A	#N/A
V32	1999	6/18/1999	#N/A	#N/A	#N/A	9550	#N/A	#N/A	#N/A	#N/A	#N/A	#N/A	#N/A	#N/A	#N/A	#N/A	#N/A	#N/A	#N/A	#N/A	#N/A	
V32	1999	8/12/1999	#N/A	-0.01	#N/A	#N/A	0.711	#N/A	#N/A	#N/A	#N/A	#N/A	#N/A	#N/A	19	#N/A	#N/A	#N/A	-0.005	#N/A	#N/A	#N/A
V32	1999	8/12/1999	#N/A	#N/A	#N/A	17010	#N/A	#N/A	#N/A	#N/A	#N/A	#N/A	#N/A	#N/A	#N/A	#N/A	#N/A	#N/A	#N/A	#N/A	#N/A	
V32	1999	8/12/1999	#N/A	#N/A	#N/A	#N/A	#N/A	#N/A	#N/A	#N/A	#N/A	#N/A	#N/A	#N/A	#N/A	#N/A	#N/A	#N/A	#N/A	#N/A	#N/A	
V32	1999	10/12/1999	#N/A	-0.01	#N/A	#N/A	0.677	#N/A	#N/A	#N/A	#N/A	#N/A	#N/A	#N/A	1	#N/A	#N/A	#N/A	0.068	#N/A	#N/A	#N/A
V32	1999	10/12/1999	#N/A	#N/A	#N/A	#N/A	#N/A	#N/A	#N/A	#N/A	#N/A	#N/A	#N/A	#N/A	#N/A	#N/A	#N/A	#N/A	#N/A	#N/A	#N/A	
V32	1999	10/12/1999	#N/A	#N/A	#N/A	16970	#N/A	#N/A	#N/A	#N/A	#N/A	#N/A	#N/A	#N/A	#N/A	#N/A	#N/A	#N/A	#N/A	#N/A	#N/A	
V32	1999	12/13/1999	#N/A	-0.01	#N/A	#N/A	0.763	#N/A	#N/A	#N/A	#N/A	#N/A	#N/A	#N/A	#N/A	#N/A	#N/A	#N/A	-0.005	#N/A	#N/A	#N/A
V32	1999	12/13/1999	#N/A	#N/A	#N/A	14645	#N/A	#N/A	#N/A	#N/A	#N/A	#N/A	#N/A	#N/A	#N/A	#N/A	#N/A	#N/A	#N/A	#N/A	#N/A	
V32	1999	12/13/1999	#N/A	#N/A	#N/A	#N/A	#N/A	#N/A	#N/A	#N/A	#N/A	#N/A	#N/A	#N/A	#N/A	#N/A	#N/A	#N/A	#N/A	#N/A	#N/A	
V32	2000	5/31/2000	#N/A	-0.01	#N/A	#N/A	0.679	#N/A	#N/A	#N/A	#N/A	#N/A	#N/A	#N/A	11	#N/A	#N/A	#N/A	0.064	#N/A	#N/A	#N/A
V32	2000	5/31/2000	#N/A	#N/A	#N/A	15389	#N/A	#N/A	#N/A	#N/A	#N/A	#N/A	#N/A	#N/A	#N/A	#N/A	#N/A	#N/A	#N/A	#N/A	#N/A	
V32	2000	5/31/2000	#N/A	#N/A	#N/A	#N/A	#N/A	#N/A	#N/A	#N/A	#N/A	#N/A	#N/A	#N/A	#N/A	#N/A	#N/A	#N/A	#N/A	#N/A	#N/A	
V32	2000	9/12/2000	#N/A	-0.01	#N/A	#N/A	0.662	#N/A	#N/A	#N/A	#N/A	#N/A	#N/A	#N/A	5.7	#N/A	#N/A	#N/A	0.107	#N/A	#N/A	#N/A
V32	2000	9/12/2000	#N/A	#N/A	#N/A	17040	#N/A	#N/A	#N/A	#N/A	#N/A	#N/A	#N/A	#N/A	#N/A	#N/A	#N/A	#N/A	#N/A	#N/A	#N/A	
V32	2001	6/13/2001	#N/A	-0.01	#N/A	#N/A	0.51	#N/A	#N/A	#N/A	#N/A	#N/A	#N/A	#N/A	8.7	#N/A	#N/A	#N/A	#N/A	#N/A	#N/A	#N/A
V32	2001	6/13/2001	#N/A	#N/A	#N/A	14666	#N/A	#N/A	#N/A	#N/A	#N/A	#N/A	#N/A	#N/A	#N/A	#N/A	#N/A	#N/A	#N/A	#N/A	#N/A	
V32	2001	6/13/2001	#N/A	#N/A	#N/A	#N/A	#N/A	#N/A	#N/A	#N/A	#N/A	#N/A	#N/A	#N/A	#N/A	#N/A	#N/A	#N/A	2.179	#N/A	#N/A	#N/A
V32	2003	6/17/2003	#N/A	-0.002	-0.002	25050	1.062	1.075	8576.6	#N/A	#N/A	#N/A	#N/A	#N/A	#N/A	#N/A	#N/A	#N/A	#N/A	0.003	#N/A	-0.002
V32	2003	6/17/2003	#N/A	#N/A	#N/A	#N/A	#N/A	#N/A	#N/A	#N/A	#N/A	#N/A	#N/A	#N/A	#N/A	#N/A	#N/A	#N/A	#N/A	#N/A	#N/A	#N/A
V32	2003	9/15/2003	#N/A	0.022	#N/A	6431	1.089	#N/A	#N/A	#N/A	#N/A	#N/A	#N/A	#N/A	5.2	#N/A	#N/A	#N/A	#N/A	#N/A	#N/A	-0.002
V32	2003	9/15/2003	#N/A	#N/A	#N/A	#N/A	#N/A	#N/A	#N/A	#N/A	#N/A	#N/A	#N/A	#N/A	#N/A	#N/A	#N/A	#N/A	0.004	#N/A	#N/A	#N/A
V32	2004	6/28/2004	#N/A	-0.001	#N/A	41100	0.15	#N/A	#N/A	#N/A	#N/A	-0.001	#N/A	17.3	#N/A	0.019	#N/A	0.005	#N/A	#N/A	#N/A	0.0096
V32	2004	6/28/2004	#N/A	#N/A	#N/A	#N/A	#N/A	#N/A	#N/A	#N/A	#N/A	#N/A	#N/A	#N/A	#N/A	#N/A	#N/A	#N/A	#N/A	#N/A	#N/A	#N/A
V32	2004	6/28/2004	#N/A	#N/A	#N/A	#N/A	#N/A	#N/A	#N/A	#N/A	#N/A	#N/A	#N/A	#N/A	#N/A	#N/A	#N/A	#N/A	#N/A	#N/A	#N/A	#N/A
V32	2004	9/20/2004	#N/A	-0.001	#N/A	93000	0.68	#N/A	#N/A	#N/A	#N/A	-0.001	1.8	#N/A	#N/A	0.016	#N/A	#N/A	#N/A	#N/A	#N/A	0.012
V32	2004	9/20/2004	#N/A	#N/A	#N/A	#N/A	#N/A	#N/A	#N/A	#N/A	#N/A	#N/A	#N/A	#N/A	#N/A	#N/A	#N/A	#N/A	#N/A	#N/A	#N/A	#N/A
V32	2004	9/20/2004	#N/A	#N/A	#N/A	#N/A	#N/A	#N/A	#N/A	#N/A	#N/A	#N/A	#N/A	#N/A	#N/A	#N/A	#N/A	#N/A	0.004	#N/A	#N/A	#N/A
V32	2005	6/22/2005	#N/A	-0.001	#N/A	59900	0.044	#N/A	#N/A	#N/A	#N/A	-0.001	10	#N/A	#N/A	0.0098	#N/A	0.002	#N/A	#N/A	#N/A	0.0081
V32	2005	6/22/2005	#N/A	#N/A	#N/A	#N/A	#N/A	#N/A	#N/A	#N/A	#N/A	#N/A	#N/A	#N/A	#N/A	#N/A	#N/A	#N/A	#N/A	#N/A	#N/A	#N/A
V32	2005	9/19/2005	#N/A	-0.001	#N/A	59300	0.064	#N/A	#N/A	#N/A	#N/A	-0.001	6.7	#N/A	#N/A	0.012	#N/A	0.004	#N/A	#N/A	#N/A	0.012
V32	2005	9/19/2005	#N/A	#N/A	#N/A	#N/A	#N/A	#N/A	#N/A	#N/A	#N/A	#N/A	#N/A	#N/A	#N/A	#N/A	#N/A	#N/A	#N/A	#N/A	#N/A	#N/A
V32	2006	6/8/2006	#N/A	-0.001	#N/A	53900	0.99	#N/A	#N/A	#N/A	#N/A	-0.001	11.5	#N/A	#N/A	0.012	#N/A	0.002	#N/A	#N/A	#N/A	0.012
V32	2006	9/18/2006	#N/A	-0.001	#N/A	65900	1.16	#N/A	#N/A	#N/A	#N/A	-0.001	3.8	#N/A	#N/A	0.0087	#N/A	0.004	#N/A	#N/A	#N/A	0.014
V32	2007	6/11/2007	#N/A	-0.001	#N/A	54500	1	#N/A	#N/A	#N/A	#N/A	-0.001	12.1	#N/A	#N/A	0.023	#N/A	0.005	#N/A	#N/A	#N/A	0.021
V32	2007	10/1/2007	#N/A	-3	#N/A	67400	0.4	#N/A	#N/A	#N/A	#N/A	#N/A	0.4	#N/A	#N/A	#N/A	#N/A	-0.5	#N/A	#N/A	#N/A	#N/A
V32	2008	6/1/2008	#N/A	-0.001	#N/A	78200	1.04	#N/A	#N/A	#N/A	#N/A	-0.001	8.6	#N/A	#N/A	0.009	#N/A	0.006	#N/A	#N/A	#N/A	0.011
V32	2008	9/29/2008	#N/A	-0.001	#N/A	53700	0.75	#N/A	#N/A	#N/A	#N/A	-0.001	4	#N/A	#N/A	0.013	#N/A	0.005	#N/A	#N/A	#N/A	0.0078

## Drainage Chemistry for Monitoring Location V32, Vangorda Mine Waste Rock Dump

STATION	YEAR	DATE	TL-T mg/L	TOC mg/L	TSS mg/L	TURB NTU	U-D mg/L	U-T mg/L	V-D mg/L	V-T mg/L	WL ELEV m	WL-S m	W-T mg/L	ZN-D mg/L	ZN-IH mg/L	ZN-T mg/L	ZR-D mg/L	ZR-T mg/L
V32	1988	6/15/1988	#N/A	#N/A	#N/A	#N/A	#N/A	#N/A	#N/A	#N/A	#N/A	#N/A	#N/A	#N/A	#N/A	#N/A	#N/A	#N/A
V32	1988	7/7/1988	#N/A	#N/A	#N/A	#N/A	#N/A	#N/A	#N/A	#N/A	#N/A	#N/A	#N/A	#N/A	#N/A	0.021	#N/A	#N/A
V32	1988	7/11/1988	#N/A	#N/A	#N/A	#N/A	#N/A	#N/A	#N/A	#N/A	#N/A	#N/A	#N/A	#N/A	#N/A	0.01	#N/A	#N/A
V32	1988	7/20/1988	#N/A	#N/A	#N/A	#N/A	#N/A	#N/A	#N/A	#N/A	#N/A	#N/A	#N/A	#N/A	#N/A	0.019	#N/A	#N/A
V32	1988	7/27/1988	#N/A	#N/A	#N/A	#N/A	#N/A	#N/A	#N/A	#N/A	#N/A	#N/A	#N/A	#N/A	#N/A	#N/A	#N/A	#N/A
V32	1988	8/24/1988	#N/A	#N/A	-1	#N/A	#N/A	#N/A	#N/A	#N/A	#N/A	#N/A	#N/A	#N/A	#N/A	0.008	#N/A	#N/A
V32	1988	8/24/1988	#N/A	#N/A	#N/A	#N/A	#N/A	#N/A	#N/A	#N/A	#N/A	#N/A	#N/A	#N/A	#N/A	#N/A	#N/A	#N/A
V32	1988	9/13/1988	#N/A	#N/A	-1	#N/A	#N/A	#N/A	#N/A	#N/A	#N/A	#N/A	#N/A	#N/A	#N/A	0.015	#N/A	#N/A
V32	1988	9/13/1988	#N/A	#N/A	#N/A	#N/A	#N/A	#N/A	#N/A	#N/A	#N/A	#N/A	#N/A	#N/A	#N/A	#N/A	#N/A	#N/A
V32	1988	10/6/1988	#N/A	#N/A	-1	#N/A	#N/A	#N/A	#N/A	#N/A	#N/A	#N/A	#N/A	#N/A	#N/A	0.003	#N/A	#N/A
V32	1988	10/6/1988	#N/A	#N/A	#N/A	#N/A	#N/A	#N/A	#N/A	#N/A	#N/A	#N/A	#N/A	#N/A	#N/A	#N/A	#N/A	#N/A
V32	1994	8/9/1994	#N/A	#N/A	116	2	#N/A	#N/A	#N/A	-0.002	#N/A	#N/A	#N/A	#N/A	#N/A	1680	#N/A	#N/A
V32	1994	8/9/1994	#N/A	#N/A	#N/A	#N/A	#N/A	#N/A	#N/A	#N/A	#N/A	#N/A	#N/A	#N/A	#N/A	#N/A	#N/A	#N/A
V32	1994	8/9/1994	#N/A	#N/A	#N/A	#N/A	#N/A	#N/A	#N/A	#N/A	#N/A	#N/A	#N/A	#N/A	#N/A	#N/A	#N/A	#N/A
V32	1994	8/9/1994	#N/A	#N/A	#N/A	#N/A	#N/A	#N/A	#N/A	#N/A	#N/A	#N/A	#N/A	#N/A	#N/A	#N/A	#N/A	#N/A
V32	1994	8/9/1994	#N/A	#N/A	#N/A	#N/A	#N/A	#N/A	#N/A	#N/A	#N/A	#N/A	#N/A	#N/A	#N/A	#N/A	#N/A	#N/A
V32	1995	5/9/1995	#N/A	#N/A	38	170	#N/A	#N/A	#N/A	-0.002	#N/A	#N/A	#N/A	#N/A	#N/A	1220	#N/A	#N/A
V32	1995	5/9/1995	#N/A	#N/A	#N/A	#N/A	#N/A	#N/A	#N/A	#N/A	#N/A	#N/A	#N/A	#N/A	#N/A	#N/A	#N/A	#N/A
V32	1995	5/9/1995	#N/A	#N/A	#N/A	#N/A	#N/A	#N/A	#N/A	#N/A	#N/A	#N/A	#N/A	#N/A	#N/A	#N/A	#N/A	#N/A
V32	1995	5/9/1995	#N/A	#N/A	#N/A	#N/A	#N/A	#N/A	#N/A	#N/A	#N/A	#N/A	#N/A	#N/A	#N/A	#N/A	#N/A	#N/A
V32	1996	5/27/1996	#N/A	#N/A	#N/A	#N/A	#N/A	#N/A	-0.05	#N/A	#N/A	#N/A	#N/A	851	#N/A	#N/A	#N/A	#N/A
V32	1996	5/27/1996	#N/A	#N/A	#N/A	#N/A	#N/A	#N/A	#N/A	#N/A	#N/A	#N/A	#N/A	#N/A	#N/A	#N/A	#N/A	#N/A
V32	1996	9/11/1996	#N/A	#N/A	67	#N/A	#N/A	#N/A	-0.05	#N/A	#N/A	#N/A	#N/A	964.9	#N/A	#N/A	#N/A	#N/A
V32	1996	9/11/1996	#N/A	#N/A	#N/A	#N/A	#N/A	#N/A	#N/A	#N/A	#N/A	#N/A	#N/A	#N/A	#N/A	#N/A	#N/A	#N/A
V32	1996	9/11/1996	#N/A	#N/A	#N/A	#N/A	#N/A	#N/A	#N/A	#N/A	#N/A	#N/A	#N/A	#N/A	#N/A	#N/A	#N/A	#N/A
V32	1997	5/12/1997	#N/A	#N/A	#N/A	#N/A	#N/A	#N/A	#N/A	0.047	#N/A	#N/A	2.55	#N/A	#N/A	726.06	#N/A	#N/A
V32	1997	5/12/1997	#N/A	#N/A	#N/A	#N/A	#N/A	#N/A	#N/A	#N/A	#N/A	#N/A	#N/A	#N/A	#N/A	#N/A	#N/A	#N/A
V32	1997	5/12/1997	#N/A	#N/A	#N/A	#N/A	#N/A	#N/A	#N/A	#N/A	#N/A	#N/A	#N/A	#N/A	#N/A	#N/A	#N/A	#N/A
V32	1997	6/30/1997	#N/A	#N/A	17	#N/A	#N/A	#N/A	-0.005	-0.005	#N/A	#N/A	45.7	849.5	#N/A	843.64	#N/A	#N/A
V32	1997	6/30/1997	#N/A	#N/A	#N/A	#N/A	#N/A	#N/A	#N/A	#N/A	#N/A	#N/A	#N/A	#N/A	#N/A	#N/A	#N/A	#N/A
V32	1997	7/22/1997	#N/A	#N/A	45	#N/A	#N/A	#N/A	-0.005	#N/A	#N/A	#N/A	#N/A	1986	#N/A	#N/A	#N/A	#N/A
V32	1997	7/22/1997	#N/A	#N/A	#N/A	#N/A	#N/A	#N/A	#N/A	#N/A	#N/A	#N/A	#N/A	#N/A	#N/A	#N/A	#N/A	#N/A
V32	1997	7/22/1997	#N/A	#N/A	#N/A	#N/A	#N/A	#N/A	#N/A	#N/A	#N/A	#N/A	#N/A	#N/A	#N/A	#N/A	#N/A	#N/A
V32	1997	8/6/1997	#N/A	#N/A	#N/A	#N/A	#N/A	#N/A	#N/A	#N/A	#N/A	#N/A	#N/A	#N/A	#N/A	#N/A	#N/A	#N/A
V32	1997	8/11/1997	#N/A	#N/A	51	#N/A	#N/A	#N/A	#N/A	-0.005	#N/A	#N/A	-0.03	#N/A	#N/A	865.48	#N/A	#N/A
V32	1997	8/11/1997	#N/A	#N/A	#N/A	#N/A	#N/A	#N/A	#N/A	#N/A	#N/A	#N/A	#N/A	#N/A	#N/A	#N/A	#N/A	#N/A
V32	1997	8/11/1997	#N/A	#N/A	#N/A	#N/A	#N/A	#N/A	-0.005	#N/A	#N/A	#N/A	#N/A	832.97	#N/A	#N/A	#N/A	#N/A
V32	1997	9/30/1997	#N/A	#N/A	29	#N/A	#N/A	#N/A	#N/A	#N/A	#N/A	#N/A	#N/A	#N/A	#N/A	#N/A	#N/A	#N/A
V32	1997	9/30/1997	#N/A	#N/A	#N/A	#N/A	#N/A	#N/A	#N/A	#N/A	#N/A	#N/A	#N/A	#N/A	#N/A	#N/A	#N/A	#N/A
V32	1997	9/30/1997	#N/A	#N/A	#N/A	#N/A	#N/A	#N/A	#N/A	-0.005	#N/A	#N/A	38.58	#N/A	#N/A	1652	#N/A	#N/A
V32	1997	9/30/1997	#N/A	#N/A	#N/A	#N/A	#N/A	#N/A	-0.005	#N/A	#N/A	#N/A	#N/A	1682	#N/A	#N/A	#N/A	#N/A
V32	1997	10/20/1997	#N/A	#N/A	#N/A	#N/A	#N/A	#N/A	-0.005	#N/A	#N/A	#N/A	#N/A	1957	#N/A	#N/A	#N/A	#N/A
V32	1997	10/20/1997	#N/A	#N/A	#N/A	#N/A	#N/A	#N/A	#N/A	#N/A	#N/A	#N/A	#N/A	#N/A	#N/A	#N/A	#N/A	#N/A
V32	1997	10/20/1997	#N/A	#N/A	#N/A	#N/A	#N/A	#N/A	#N/A	#N/A	#N/A	#N/A	#N/A	#N/A	#N/A	#N/A	#N/A	#N/A
V32	1997	12/22/1997	#N/A	#N/A	#N/A	#N/A	#N/A	#N/A	-0.005	#N/A	#N/A	#N/A	#N/A	1788.2	#N/A	#N/A	#N/A	#N/A
V32	1997	12/22/1997	#N/A	#N/A	#N/A	#N/A	#N/A	#N/A	#N/A	#N/A	#N/A	#N/A	#N/A	#N/A	#N/A	#N/A	#N/A	#N/A
V32	1998	5/18/1998	#N/A	#N/A	#N/A	#N/A	#N/A	#N/A	-0.005	#N/A	#N/A	#N/A	#N/A	706.1	#N/A	#N/A	#N/A	#N/A
V32	1998	5/18/1998	#N/A	#N/A	#N/A	#N/A	#N/A	#N/A	#N/A	#N/A	#N/A	#N/A	#N/A	#N/A	#N/A	#N/A	#N/A	#N/A
V32	1998	6/29/1998	#N/A	#N/A	#N/A	#N/A	#N/A	#N/A	0.184	#N/A	#N/A	#N/A	#N/A	1800.2	#N/A	#N/A	#N/A	#N/A
V32	1998	6/29/1998	#N/A	#N/A	#N/A	#N/A	#N/A	#N/A	#N/A	#N/A	#N/A	#N/A	#N/A	#N/A	#N/A	#N/A	#N/A	#N/A
V32	1998	6/29/1998	#N/A	#N/A	#N/A	#N/A	#N/A	#N/A	#N/A	#N/A	#N/A	#N/A	#N/A	#N/A	#N/A	#N/A	#N/A	#N/A
V32	1998	9/14/1998	#N/A	#N/A	#N/A	#N/A	#N/A	#N/A	-0.005	#N/A	#N/A	#N/A	#N/A	2179.79	#N/A	#N/A	#N/A	#N/A
V32	1998	9/14/1998	#N/A	#N/A	#N/A	#N/A	#N/A	#N/A	#N/A	#N/A	#N/A	#N/A	#N/A	#N/A	#N/A	#N/A	#N/A	#N/A
V32	1998	9/14/1998	#N/A	#N/A	#N/A	#N/A	#N/A	#N/A	#N/A	#N/A	#N/A	#N/A	#N/A	#N/A	#N/A	#N/A	#N/A	#N/A

## Drainage Chemistry for Monitoring Location V32, Vangorda Mine Waste Rock Dump

STATION	YEAR	DATE	TL-T mg/L	TOC mg/L	TSS mg/L	TURB NTU	U-D mg/L	U-T mg/L	V-D mg/L	V-T mg/L	WL ELEV m	WL-S m	W-T mg/L	ZN-D mg/L	ZN-IH mg/L	ZN-T mg/L	ZR-D mg/L	ZR-T mg/L
V32	1999	5/18/1999	#N/A	#N/A	#N/A	#N/A	#N/A	#N/A	-0.005	#N/A	#N/A	#N/A	#N/A	1155.76	#N/A	#N/A	#N/A	#N/A
V32	1999	5/18/1999	#N/A	#N/A	#N/A	#N/A	#N/A	#N/A	#N/A	#N/A	#N/A	#N/A	#N/A	#N/A	#N/A	#N/A	#N/A	#N/A
V32	1999	6/18/1999	#N/A	#N/A	#N/A	#N/A	#N/A	#N/A	-0.005	#N/A	#N/A	#N/A	#N/A	2243.28	#N/A	#N/A	#N/A	#N/A
V32	1999	6/18/1999	#N/A	#N/A	#N/A	#N/A	#N/A	#N/A	#N/A	#N/A	#N/A	#N/A	#N/A	#N/A	#N/A	#N/A	#N/A	#N/A
V32	1999	8/12/1999	#N/A	#N/A	#N/A	#N/A	#N/A	#N/A	#N/A	#N/A	#N/A	#N/A	#N/A	4044	#N/A	#N/A	#N/A	#N/A
V32	1999	8/12/1999	#N/A	#N/A	#N/A	#N/A	#N/A	#N/A	#N/A	#N/A	#N/A	#N/A	#N/A	#N/A	#N/A	#N/A	#N/A	#N/A
V32	1999	8/12/1999	#N/A	#N/A	#N/A	#N/A	#N/A	#N/A	0.503	#N/A	#N/A	#N/A	#N/A	#N/A	#N/A	#N/A	#N/A	#N/A
V32	1999	10/12/1999	#N/A	#N/A	#N/A	#N/A	#N/A	#N/A	-0.005	#N/A	#N/A	#N/A	#N/A	2886	#N/A	#N/A	#N/A	#N/A
V32	1999	10/12/1999	#N/A	#N/A	#N/A	#N/A	#N/A	#N/A	#N/A	#N/A	#N/A	#N/A	#N/A	#N/A	#N/A	#N/A	#N/A	#N/A
V32	1999	10/12/1999	#N/A	#N/A	#N/A	#N/A	#N/A	#N/A	#N/A	#N/A	#N/A	#N/A	#N/A	#N/A	#N/A	#N/A	#N/A	#N/A
V32	1999	12/13/1999	#N/A	#N/A	#N/A	#N/A	#N/A	#N/A	-0.005	#N/A	#N/A	#N/A	#N/A	3101.95	#N/A	#N/A	#N/A	#N/A
V32	1999	12/13/1999	#N/A	#N/A	#N/A	#N/A	#N/A	#N/A	#N/A	#N/A	#N/A	#N/A	#N/A	#N/A	#N/A	#N/A	#N/A	#N/A
V32	1999	12/13/1999	#N/A	#N/A	#N/A	#N/A	#N/A	#N/A	#N/A	#N/A	#N/A	#N/A	#N/A	#N/A	#N/A	#N/A	#N/A	#N/A
V32	2000	5/31/2000	#N/A	#N/A	#N/A	#N/A	#N/A	#N/A	-0.005	#N/A	#N/A	#N/A	#N/A	3410.8	#N/A	#N/A	#N/A	#N/A
V32	2000	5/31/2000	#N/A	#N/A	#N/A	#N/A	#N/A	#N/A	#N/A	#N/A	#N/A	#N/A	#N/A	#N/A	#N/A	#N/A	#N/A	#N/A
V32	2000	5/31/2000	#N/A	#N/A	#N/A	#N/A	#N/A	#N/A	#N/A	#N/A	#N/A	#N/A	#N/A	#N/A	#N/A	#N/A	#N/A	#N/A
V32	2000	9/12/2000	#N/A	#N/A	#N/A	#N/A	#N/A	#N/A	-0.005	#N/A	#N/A	#N/A	#N/A	1099.82	#N/A	#N/A	#N/A	#N/A
V32	2000	9/12/2000	#N/A	#N/A	#N/A	#N/A	#N/A	#N/A	#N/A	#N/A	#N/A	#N/A	#N/A	#N/A	#N/A	#N/A	#N/A	#N/A
V32	2001	6/13/2001	#N/A	#N/A	99	#N/A	#N/A	#N/A	-0.005	#N/A	#N/A	#N/A	#N/A	6700	#N/A	#N/A	#N/A	#N/A
V32	2001	6/13/2001	#N/A	#N/A	#N/A	#N/A	#N/A	#N/A	#N/A	#N/A	#N/A	#N/A	#N/A	#N/A	#N/A	#N/A	#N/A	#N/A
V32	2001	6/13/2001	#N/A	#N/A	#N/A	#N/A	#N/A	#N/A	#N/A	#N/A	#N/A	#N/A	#N/A	#N/A	#N/A	#N/A	#N/A	#N/A
V32	2003	6/17/2003	-0.002	#N/A	#N/A	#N/A	#N/A	#N/A	-0.001	-0.001	#N/A	#N/A	-0.03	2994.352	#N/A	5106.077	#N/A	#N/A
V32	2003	6/17/2003	#N/A	#N/A	292	#N/A	#N/A	#N/A	#N/A	#N/A	#N/A	#N/A	#N/A	#N/A	#N/A	#N/A	#N/A	#N/A
V32	2003	9/15/2003	#N/A	#N/A	#N/A	#N/A	#N/A	#N/A	0.002	#N/A	#N/A	#N/A	#N/A	8231.812	#N/A	#N/A	#N/A	#N/A
V32	2003	9/15/2003	#N/A	#N/A	#N/A	#N/A	#N/A	#N/A	#N/A	#N/A	#N/A	#N/A	#N/A	#N/A	#N/A	#N/A	#N/A	#N/A
V32	2004	6/28/2004	#N/A	#N/A	-1	#N/A	0.184	#N/A	-0.001	#N/A	#N/A	#N/A	#N/A	7510	#N/A	#N/A	-0.01	#N/A
V32	2004	6/28/2004	#N/A	#N/A	#N/A	#N/A	#N/A	#N/A	#N/A	#N/A	#N/A	#N/A	#N/A	#N/A	#N/A	#N/A	#N/A	#N/A
V32	2004	6/28/2004	#N/A	#N/A	#N/A	#N/A	#N/A	#N/A	#N/A	#N/A	#N/A	#N/A	#N/A	#N/A	#N/A	#N/A	#N/A	#N/A
V32	2004	9/20/2004	#N/A	#N/A	43	#N/A	0.562	#N/A	0.004	#N/A	#N/A	#N/A	#N/A	10700	#N/A	#N/A	-0.01	#N/A
V32	2004	9/20/2004	#N/A	#N/A	#N/A	#N/A	#N/A	#N/A	#N/A	#N/A	#N/A	#N/A	#N/A	#N/A	#N/A	#N/A	#N/A	#N/A
V32	2004	9/20/2004	#N/A	#N/A	#N/A	#N/A	#N/A	#N/A	#N/A	#N/A	#N/A	#N/A	#N/A	#N/A	#N/A	#N/A	#N/A	#N/A
V32	2005	6/22/2005	#N/A	#N/A	11	#N/A	0.502	#N/A	0.004	#N/A	#N/A	#N/A	#N/A	10200	#N/A	#N/A	-0.01	#N/A
V32	2005	6/22/2005	#N/A	#N/A	#N/A	#N/A	#N/A	#N/A	#N/A	#N/A	#N/A	#N/A	#N/A	#N/A	#N/A	#N/A	#N/A	#N/A
V32	2005	9/19/2005	#N/A	#N/A	28	#N/A	0.611	#N/A	0.005	#N/A	#N/A	#N/A	#N/A	10500	#N/A	#N/A	-0.01	#N/A
V32	2005	9/19/2005	#N/A	#N/A	#N/A	#N/A	#N/A	#N/A	#N/A	#N/A	#N/A	#N/A	#N/A	#N/A	#N/A	#N/A	#N/A	#N/A
V32	2006	6/8/2006	#N/A	#N/A	#N/A	#N/A	0.393	#N/A	0.004	#N/A	#N/A	#N/A	#N/A	9820	#N/A	#N/A	-0.01	#N/A
V32	2006	9/18/2006	#N/A	#N/A	#N/A	#N/A	0.409	#N/A	0.005	#N/A	#N/A	#N/A	#N/A	10600	#N/A	#N/A	-0.01	#N/A
V32	2007	6/11/2007	#N/A	#N/A	11	#N/A	0.946	#N/A	0.007	#N/A	#N/A	#N/A	#N/A	10300	#N/A	#N/A	-0.01	#N/A
V32	2007	10/1/2007	#N/A	#N/A	26	#N/A	#N/A	#N/A	#N/A	#N/A	#N/A	#N/A	#N/A	11300	#N/A	#N/A	-2	#N/A
V32	2008	6/1/2008	#N/A	#N/A	29	#N/A	0.75	#N/A	0.006	#N/A	#N/A	#N/A	#N/A	12500	#N/A	#N/A	-0.01	#N/A
V32	2008	9/29/2008	#N/A	#N/A	78	#N/A	1.06	#N/A	0.005	#N/A	#N/A	#N/A	#N/A	7380	#N/A	#N/A	-0.01	#N/A

**Attachment B**

**Results of an Experiment to Evaluate Solubility Limits for Category 1 Waste Rock**

## Memo

---

<b>To:</b>	Jim Scott, PolyMet	<b>Date:</b>	February 16, 2011
<b>cc:</b>	Peter Hinck, Barr Richard Patelke, PolyMet	<b>From:</b>	Stephen Day
<b>Subject:</b>	Results of an Experiment to Evaluate Solubility Limits for Category 1 Waste Rock, NorthMet Project DRAFT	<b>Project #:</b>	1UP005.001

---

### 1 Background

#### 1.1 Introduction

The water quality prediction method for waste rock stockpiles and pit walls for the NorthMet Project relies on scale-up of laboratory tests (humidity cells) and consideration of constraining concentrations (solubility limits or concentration caps) resulting from the finite solubility of secondary minerals produced by weathering processes. As described by SRK (2010), solubility limits for some elements can be estimated using thermodynamic data for well-understood minerals (for example, sulfate constrained by gypsum solubility); however, the majority of elements occur as trace components in major secondary minerals (for example, cobalt co-precipitated with ferric oxyhydroxides). For this reason, solubility cannot be readily evaluated using thermodynamic data for the secondary minerals and other analogous data sources are needed.

SRK (2007)<sup>1</sup> previously used data from the AMAX field experiments directed by the MNDNR as analogs for the low sulfur Category 1/2 (now Category 1) waste rock stockpiles. For parameters not monitored by the MNDNR, laboratory-scale data obtained by PolyMet Inc. for the NorthMet Project were used as analogs. This approach was less than ideal because the field experiments were performed on rock classified as ore, whereas the laboratory experiments are affected by dilution resulting from the high liquid-to-solid leaching ratios. Concentrations from the field experiments may over-estimate solubility limits while laboratory experiments may under-estimate solubility limits.

This memorandum provides results of an experiment to directly evaluate solubility limits for Category 1 waste rock.

#### 1.2 Method Design

The method used is referred to as a Sequential Meteoric Water Mobility Procedure (SMWMP). It is designed to simulate the accumulation of solutes that occur as a package of water contacts oxidizing waste along a flowpath. SRK (2000)<sup>2</sup> used the method as part of assessment of the Fort Knox Mine's True North Project for the Alaska Department of Environmental Conservation (AKDEC).

---

<sup>1</sup> SRK Consulting, 2007. RS53/RS42 – Waste Rock Characteristics/Waste Water Quality Modeling - Waste Rock and Lean Ore – NorthMet Project – DRAFT 01. March 9, 2007.

<sup>2</sup> SRK Consulting 2000. Review of geochemical issues True North Project Fort Knox Mine. Prepared for Alaska Department of Environmental Conservation. . December 2000. SRK Project 1UA004.01.

It was recognized that single pass leach procedures may not give a reliable indication of contact water chemistry because:

- the time frame of leaching was not sufficient to allow the solution chemistry to approach the theoretical limits indicated by the thermodynamic properties;
- the leachate produced by dissolution of readily soluble minerals did not react with less soluble minerals;
- the high liquid to solid ratio resulted in complete dissolution of a mineral component before the solubility limit could be reached.

Concerns have been raised by others about the limitations of single pass leach tests<sup>3</sup>. The method has subsequently been used to assess solubility limits for several projects in the Yukon Territory for a Canadian federal process<sup>4</sup>, British Columbia for a provincial and federal process<sup>5</sup> and Chile.

The method is a modification of the Nevada Department of Environmental Protection's (NVDEP 1990<sup>6</sup>) Meteoric Water Mobility Procedure Method (MWMP) which results in a single pass of leachate at about a ratio of 1 L of water to 1 kg of waste. The SMWMP involves recovery of leachate from each leaching step and re-application of the leachate (less a split retained from analysis) to an unleached sample of the waste. The procedure is repeated until insufficient leachate is available for analysis. The leaching ratio (1 L/kg) is maintained for each step. As a result, the mass of sample leached in each step decreases due to loss of water for analysis and retention in the solids. The leaching ratio in the final step is therefore  $\frac{1}{n}$  L/kg where n is the number of leaching steps.

To be effective, the method must be performed on well-oxidized waste so that soluble weathering products are available for leaching.

## 2 Methods

### 2.1 Composite Preparation

Coarse rejects from preparation of exploration drill core for analysis from 2005 onwards were available for testing. Six composites with sulfur concentrations of 0.02%, 0.04%, 0.06%, 0.08%, 0.10% and 0.12% were prepared by PolyMet to represent the expected range of sulfur concentrations in Category 1 waste rock. To obtain these concentrations and sufficient material (35 kg) for the procedure, it was necessary to composite materials from different locations throughout the project area.

Sample intervals used to prepare the composites are provided in Attachment 1.

Splits of each composite were analyzed for total metals and sulfur using PolyMet's exploration method. Metal analysis was performed using both an aqua regia and four-acid digestion.

### 2.2 Leach Procedure

#### 2.2.1 Initial Leach

Initial sequential shake flask extraction procedures were performed to determine if the samples had oxidized in storage and were suitable for the SMWMP. This procedure involved in a 3:1 liquid to solid extraction in which the leachate was recovered and re-applied to an unleached split. Seven

---

<sup>3</sup> Schafer, W. 2008. Critical Review of Geochemical Prediction at Mines. Paper presented at Northwest Mining Association meeting, Reno, NV. December 3, 2008.

<sup>4</sup> SRK Consulting, 2004. Results of sequential leach tests on Blue Pit waste rock Brewery Creek Mine. Report prepared for Viceroy Minerals Corporation. SRK Project 1CV001.001. February 2004.

<sup>5</sup> SRK Consulting, 2006. Galore Creek Project ML/ARD Characterization Report. Report prepared for Novagold Resources Inc. SRK Project. 1CR003.002. May 2006.

<sup>6</sup> Nevada Division of Environmental Protection. 1990. Meteoric Water Mobility Procedure, Bureau of Mining Regulation and Reclamation, Nevada Division of Environmental Protection, 9/19/90. 6 pages.  
<http://ndep.nv.gov/bmrr/mobilty1.pdf>.

24-hour leaching steps were performed and each leachate was analyzed for pH and conductivity. The final leachate was also analyzed for sulfate. The procedure confirmed the composites contained oxidation products and were suitable for the SMWMP.

### 2.2.2 SMWMP

The leaching procedure consisted of a series of extractions performed in columns. The leachate from each column was used as the feed for leaching of a fresh sample.

Each leaching step was performed in a leach column as follows:

- The sample was placed in a 15.2 cm diameter column.
- The volume of feed water was determined as the amount needed to achieve a 1:1 leachate to sample ratio using the procedure described by NVDEP (1990). This volume was dripped through the column over a period of 96 hours.
- 200 mL of the resulting leachate is removed for analysis and the remainder is used for the next leach step.

Due to the decrease in leachate volume from retention of water in the solids, the mass of sample was calculated to provide sufficient leachate for seven leaching steps.

Leachates were analyzed for at least pH, Eh, electrical conductivity, ORP, dissolved major cations and anions and trace ions. The mass of sample used in each step, the volume of water applied and the volume of water collected from each stage were recorded.

## 2.3 Quality Control

A method blank using exactly the same procedure was used to assess the potential effects of the column construction materials. The resulting leachate had a pH 4.99 and conductivity of 3  $\mu\text{S}/\text{cm}$ . Major ions were not detected in the leachates though several trace elements were detected at below parts per billion levels. The most significant detection was copper at 0.004 mg/L.

Leachate ion balances were normally within  $\pm 10\%$  with exceptions occurring in the first and second relatively dilute leach cycles. Imbalances were generally positive (cation excess) with the exception of the two samples containing the higher sulfur concentrations which yielded some negative imbalances between 5 and 10%.

Due to the small volume of leachate available in the final leaching step, and the presence of highest ion strengths (therefore requiring leachate dilution), analytical precision was lowest for these analyses.

## 3 Results

### 3.1 Solid Characteristics

Solids characteristics are provided in Table 1.

**Table 1: Composite Solids Characteristics**

Composite	Total S %	As mg/kg	Cd mg/kg	Co mg/kg	Cr mg/kg	Cu mg/kg	Fe %	Ni mg/kg	Sb mg/kg	Zn mg/kg
CAPCON 2	0.02	0.1	0.03	39.7	77	117.5	4.44	189	<0.05	49
CAPCON 4	0.04	0.3	0.09	44.3	94	214	5.61	185.5	0.1	70
CAPCON 6	0.05	0.6	0.07	45.8	72	284	5.48	217	0.06	65
CAPCON 8	0.07	0.4	0.09	44.1	91	354	5.58	206	0.07	72
CAPCON 10	0.1	2.8	0.14	48.2	90	457	6.05	226	0.12	76
CAPCON 12	0.11	2	0.09	51.7	54	560	6.57	278	0.14	77

1. Element concentrations determined by aqua regia.

Source:G:\PolyMet Mining\1UP005.01\_Northmet\_project\_2004\Testwork\2010-07\_SWMP\4.Interpretations\[SMWMP\_Graphs\_1UP005001\_SJD.ver00.xlsx]

## 3.2 SMWMP Leachates

Attachment 2 shows charts for each element.

### 3.2.1 Major Ions

All leachates reached stable pHs after the first leach step. The range of stable pHs was from 7.9 to 8.4 with lowest pHs from the higher sulfur samples. Anion chemistry was dominated by sulfate and alkalinity (as bicarbonate), but chloride reached 490 mg/L for composite 10. Cation chemistry was dominated by sodium then calcium and magnesium. Sulfate increased as the experiment continued resulting in final concentrations ranging from 110 mg/L to 910 mg/L. Sulfate leaching was exactly correlated with sulfur content.

Alkalinity showed the reverse trend with lowest alkalinity correlated with higher sulfur content. Alkalinity increased mostly rapidly earliest then tended to stabilize except for the two lowest sulfur content samples which showed increasing concentrations up to 300 mgCaCO<sub>3</sub>/L.

Chloride generally increased consistently with the exception of steps 3 to 4 for Sample 10.

Cations showed upward trends with absolute values and slopes of increases being greater for the higher sulfur content samples. A tendency toward flattening was apparent for the last step but as noted in Section 2.3; results for the last step were affected by the ionic strength and small sample available for analysis.

### 3.2.2 Trace Elements

Behavior of trace elements can be divided into the following broad groups:

- Concentrations increased in parallel with sulfate and did not reach a stable well-defined level – Ba, B, Cr (erratically), Cu, Mo, Ni, Se.
- Concentrations reached stable well-defined levels – Ba, F, Sb, As, Co, Cu, Mn, Ni, P, Si.
- Low concentrations showed neither increasing nor decreasing trends but were erratic – Ag, Cd, Fe, Hg, Pb, Tl, Zn.
- Concentrations decreased as the test progressed – Al, V.
- Concentrations were consistently undetected – Be

Barium, copper and nickel are shown in two of the groups because concentrations increased for samples with higher sulfur content but appeared to be stable for samples with lower sulfur content.

Many elements yielded strong correlations of leachable concentrations with bulk sulfur content, including arsenic, barium, chromium (weak), copper, nickel and selenium. Molybdenum leaching was negatively correlated with sulfur content. A few elements also yielded leachable concentrations correlated with their bulk content of the element, including arsenic, copper, molybdenum, nickel and selenium.



Elements for which correlations were not apparent included antimony, cadmium, cobalt, lead, manganese, silver, thallium, vanadium and zinc. These elements occurred at low concentrations in leachates and/or the solid phase.

## 4 Discussion

### 4.1 Sample Representation

The targeted sulfur range in the samples was achieved with coverage of the 0 to 90<sup>th</sup> percentile of the sulfur range. As a result of the tendency for copper concentrations to increase as sulfur content also increases, copper concentrations also covered a similar percentile range.

For other elements, the correlation with sulfide content is weaker and the process of compositing resulted in near median (50<sup>th</sup> percentile) metal content in most samples except the lower sulfur content samples.

### 4.2 Leachate Chemistry

#### 4.2.1 Major Elements

Sulfate leaching was consistent with the oxidation of sulfides (pyrrhotite and chalcopyrite) in storage resulting in generation of sulfate and acidity. Sulfate leaching was strongly positively correlated with sulfur content, and the spread of pH and alkalinity showed that more acidity was generated at higher sulfide content.

The source of alkalinity for neutralization of sulfuric acid was likely to be carbonate minerals. Saturation indices for calcite and dolomite show that both minerals approached then exceeded saturation for each test<sup>7</sup> (Attachment 3). Carbonate minerals may be present as hydrothermal alteration products of plagioclase and olivine, or as weathering products accumulated while in storage. While some sodium probably accumulated in SMWMP leachates due to leaching of trapped sodium chloride connate waters and drill fluids, the presence of elevated sodium concentrations indicates that sodium and carbonate minerals accumulated partly while in storage due to weathering of plagioclase. The relative enrichment of sodium in leachates is probably a result of retention of calcium as sparingly soluble calcium carbonate. In contrast, sodium carbonate and bicarbonate are both readily soluble, and are therefore flushed from the rock. These conclusions appear to be supported by the strong correlation of the calcium leaching trend with sulfate, but much weaker sodium correlation after allowing for sodium chloride (**Figure 1**).

Silicon leaching occurred at levels well below the concentration equivalent to sodium leaching from plagioclase. Silicon concentrations appeared to be constrained. Saturation indices were below saturation for amorphous silica but above the saturation level of kaolinite. It appears that silicon leaching was constrained by formation of an alumino-silicate weathering product.

The SMWMP data did not provide a direct indication of a solubility control for sulfate because concentrations were not constrained but it is likely that gypsum will control sulfate concentrations. The release of sodium and the implied presence of calcium carbonates showed that plagioclase will contribute both sodium and calcium. Olivine will contribute magnesium. The sulfate concentration supported by this solution chemistry is dependent on the  $\frac{Ca}{(Mg + Na)}$  ratio because magnesium and sodium sulfates are highly soluble compared to gypsum. Humidity cell data indicate an average molar ratio of 1.2 which results in a modeled sulfate solubility limit of 2900 mg/L<sup>8</sup>.

<sup>7</sup> Saturation indices were calculated using PHREEQC version 2.17.4137 and MINTEQA2 version 8 database. Charts showing SI trends are provided in Attachment 3.

<sup>8</sup> Calculated using Geochemist's Workbench assuming a temperature of 3°C.

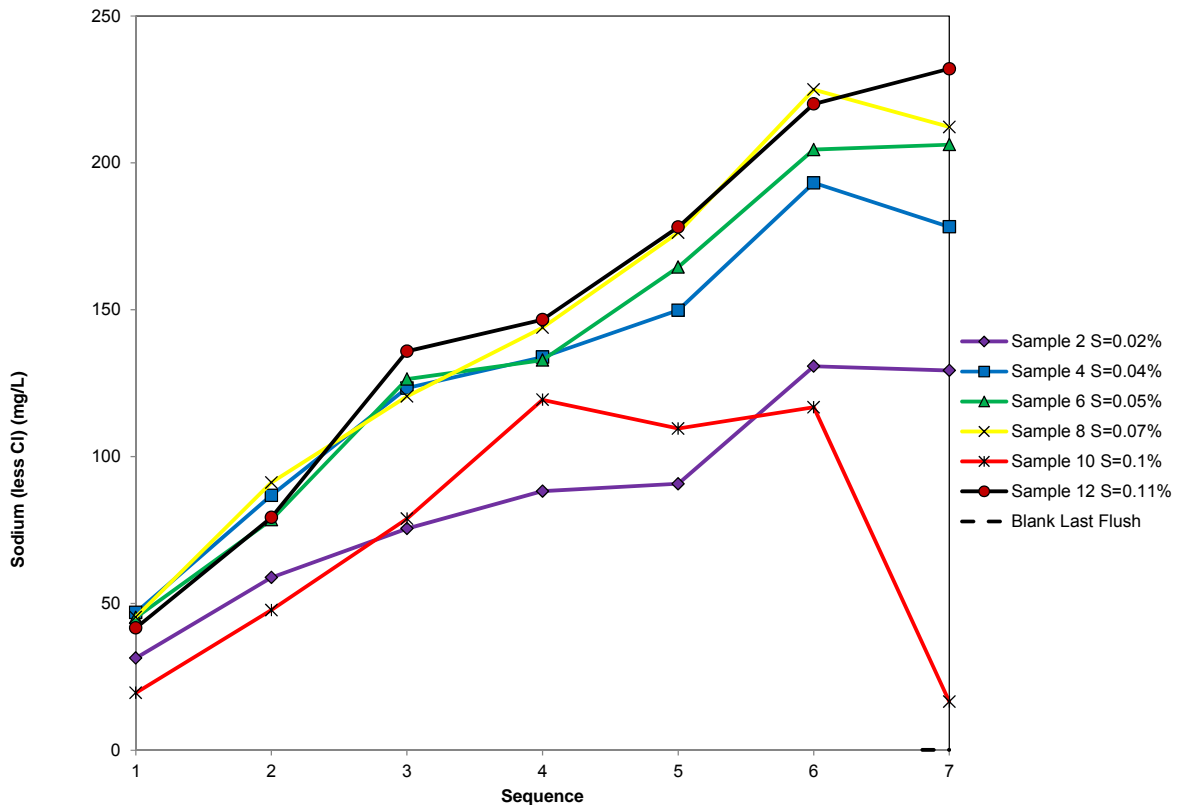

G:\PolyMet Mining\1UP005.01\_Northmet\_project\_2004\Testwork\2010-07\_SWMP\4.Interpretations\SMWMP\_Graphs\_1UP005001\_SJD.ver00.xlsx

**Figure 1: Trend in Sodium Leaching After Allowing for Sodium Associated with Chloride**

## 4.2.2 Trace Elements

### *Unconstrained Elements*

Several elements in this group (chromium, molybdenum, selenium) occur in solution as oxyanions at basic pH, or in the case of boron as uncharged  $\text{H}_3\text{BO}_3^0$ . Mobility of these ions may be high due to their weak tendency to adsorb. Molybdenum and selenium likely originate directly from oxidation of sulfide minerals. Chromium and boron are lithophile elements and therefore are probably leached from silicate rather than sulfide minerals.

Concentrations of these elements were well below saturation for secondary minerals they might form. The tests therefore did not provide a direct indication of solubility constraints for these elements. The last concentration measured indicates a minimum solubility constraint.

Both boron and chromium concentrations were close to those observed in the blank and therefore may reflect leaching of the column materials. Chromium co-precipitation with barite (see below) is a possible mechanism to constrain chromium concentrations (Prieto et al. 2002)<sup>9</sup>.

Selenium concentrations were not constrained but selenium is sequestered by gypsum (Fernández-González et al. 2006<sup>10</sup>). The selenium to sulfate ratio indicated by the tests ( $7 \times 10^{-6}$ ,  $r=0.93$ ) was used to estimate a selenium concentration constraint of 0.02 mg/L.

<sup>9</sup> Prieto, M., Fernández-González, A. and Martín-Díaz, R. 2002. Sorption of chromate ions diffusing through barite-hydrogel composites: Implications for the fate and transport of chromium in the environment. *Geochimica et Cosmochimica Acta*, Vol. 66, No. 5, pp. 783–795, 2002.

<sup>10</sup> Fernández-González, A., Andara, A., María Alía, J., and Prieto, M. 2006. Miscibility in the  $\text{CaSO}_4 \cdot 2\text{H}_2\text{O}$ – $\text{CaSeO}_4 \cdot 2\text{H}_2\text{O}$  system: Implications for the crystallisation and dehydration behaviour. *Chemical Geology*: 225 (3-4); 256-265.

Mobility of molybdenum may be controlled by formation of molybdate secondary minerals such as powellite ( $\text{CaMoO}_4$ ) or ferrimolybdate ( $\text{Fe}_2(\text{MoO}_4)_3 \cdot 8\text{H}_2\text{O}$ ). Under basic conditions, the former is more likely though it is relatively soluble and supports molybdenum concentrations between 1 and 10 mg/L (e.g. Day et al. 2000<sup>11</sup>; Day et al. 2003<sup>12</sup>).

Barium likely originates from weathering of feldspars and probably occurs as a co-precipitated carbonate. It may be constrained by barium sulfate (barite) but the barite saturation indices for the samples yielding the higher sulfate concentrations exceeded 0 implying that barium leaching was not constrained by barite.

Copper concentrations for four of the tests (sulfur concentrations exceeding 0.04%) showed upward trends in copper concentrations; however, as a result of increasing alkalinity, saturation indices for tenorite showed weaker upward possibly stabilizing trends though the indices were well below 0. This implies that copper concentrations are possibly constrained by an oxide, and that tenorite would represent a maximum solubility for copper.

Two tests with more than 0.07% sulfur showed upward trending nickel concentrations. The other tests showed low nickel concentrations which appear to be constrained at parts per billion levels. Nickel concentrations were well below secondary minerals for which saturation indices could be calculated. However, the range of saturation indices for bunsenite ( $\text{NiO}$ ) was much narrower than the range of nickel concentrations and showed flatter and similar trends for all tests implying that nickel solubility is controlled by co-precipitation with an oxide.

#### *Well-Defined Constrained Elements*

Elements in this group showed conventional behavior consistent in most cases with accumulation of solutes in sequence then stabilizing.

Antimony concentrations increased to maximum concentrations that were weakly related to sulfur content and unrelated to the low antimony content of the samples. It is likely that antimony is a trace component of sulfides, is released by oxidation then sorbed with iron oxhydroxides.

Arsenic trends in some cases showed decreases rather than increases before stabilizing. Due to the correlation with sulfur it is likely that arsenic also originates from oxidation of sulfides.

Cobalt leached at below parts per billion levels though only Sample 10 showed an increasing trend before stabilizing at 0.3  $\mu\text{g/L}$ . The trend for this sample included a jump in concentrations in step 4. Manganese showed similar trends to cobalt though Sample 10 showed a peak in step 4 before following a decreasing trend.

Fluoride leaching typically showed a peak and then decreased or was stable. There was no relationship with other parameters. Fluorite saturation indices were well below 0 due to the low calcium concentrations but the indices were relatively stable implying that fluoride is constrained though not by fluorite.

Phosphorous leaching was stable with the exception of Sample 2 which contained lowest sulfur concentrations. Other samples either showed flat or slightly decreasing trends. Leachates were well over-saturated with respect to hydroxylapatite and well undersaturated with respect to a calcium phosphate phase in the thermodynamic database. However, the inverse relationship with calcium leaching implies a calcium phosphate control on leaching.

Silicon leaching was described in Section 3.2.1.

---

<sup>11</sup> Day, S., Sexsmith, K., Bowell, R. and Hockley, D. 2000. Geochemistry of Molybdenum Leaching at British Columbia Copper and Molybdenum Mines. Presented at BC Metal Leaching and Acid Rock Drainage Workshop. December 2000.

<sup>12</sup> Day, S., Sexsmith, K and Millard, J. 2003. Acidic Drainage From Calcareous Coarse Kimberlite Reject, Ekati Diamond Mine™, Northwest Territories, Canada. Presented at Sixth International Conference on Acid Rock Drainage, Cairns, Australia. July 12 to 18, 2003. Pages 587-600.

### *Erratic Non-Trending Elements*

Silver, cadmium, lead, mercury, thallium and zinc all yielded concentrations usually within ten times of the low respective detection limits (5, 5, 30, 10, 10, 100 ng/L, respectively). Concentrations were erratic reflecting lower precision near the detection limits and no apparent increasing or decreasing trends were apparent. These elements are speciated as cations under these conditions and are therefore expected to be readily sorbed to ferric oxyhydroxides formed by oxidation of pyrrhotite. Since these elements are chalcophilic, they are probably released by oxidation of pyrrhotite which further favors sorption to ferric iron oxidation products.

Iron also falls into this group. Its concentrations were well above the saturation limits for ferrihydrite indicating that iron may have been released by the test as colloids which passed the 0.45 µm filter. This may in part contribute to the erratic concentrations indicated by the other elements though iron concentrations were not correlated with their concentrations.

### *Elements Showing Decreasing Concentrations*

Aluminum concentrations decreased as the tests progressed reaching stable concentrations lower at the end of the test than at the beginning. The trend is unexpected because the dominant aluminum species is calculated to be  $\text{Al}(\text{OH})_4^-$  which is favored as leachates became more basic. Notably, greater concentrations were observed for the low sulfur tests (higher leachate pH) and vice versa which is consistent with the ionic form and control by precipitation of a basic aluminum mineral. The decrease in aluminum suggests initial release with subsequent precipitation as another ion is released. Vanadium showed very similar results and trends. Its dominant ionic forms were calculated to be anionic ( $\text{H}_2\text{VO}_4^-$ ,  $\text{HVO}_4^{2-}$ ).

### *Non-Detected Elements*

Only beryllium was not detected consistently at its detection limit of 10 ng/L. The absence of a leaching trend does not eliminate a trend existing because it may be below the detection limit. However, concentrations were very low in the solids (close to the detection limit of 0.5 mg/kg), and beryllium most likely occurs with silicates. Also, beryllium is expected to occur in solution mainly as a cation which would favor adsorption. Low levels of beryllium leaching are therefore expected.

### *Summary of Solubility Constraints*

Table 2 compares solubility constraints indicated by SMWMPs and other methods for Category 1 waste rock with those compiled previously to broadly cover non-acidic conditions for all waste rock categories in RS42. The SMWMP values are the highest concentrations for stable conditions. The qualifier indicates the highest value is shown but the trend was not stable.

For the majority of parameters, the SMWMP provided a useful indicator of solubility constraints and are shown as not qualified in Table 2. In a few cases, the constraints increased (Sb, Hg, Tl) from those presented in RS42. For Sb, leachates from the small MDNR reactor tests were used previously due to quality control problems for humidity cells. The difference for mercury reflects the higher detection limit for the SMWMP. Other tests have more reliably shown that mercury is readily sorbed to the rock (SRK 2005). The increase for thallium was minor.

Many parameters (As, Cd, Co, Pb, Mn, Ag, Zn) yielded lower constraints reflecting that Category 1 rock is much less mineralized than the data sources used previously in RS42.

Some parameters were not constrained by the SMWMPs. For sulfate, a calculated value based on the  $\frac{\text{Ca}}{(\text{Mg} + \text{Na})}$  ratio is shown. This resulted in a higher value than used previously in RS42. Copper was not constrained but the tests imply an oxide constraint. The concentration shown is for tenorite solubility at pH 7.9 which is the low end of the observed pH range.

Boron, chromium, molybdenum and nickel were not constrained by the SMWMP. For nickel, the concentration indicated in RS42 (0.86 mg/L) remains the recommended solubility limit for basic pH conditions. Boron and chromium are not expected to be readily soluble. Leaching in the SMWMP may reflect leaching from column materials. Chromium may co-precipitate with barite.

**Table 2: Comparison of Solubility Constraints Indicated by SMWMP for Category 1 Waste Rock with RS42**

Parameter	Units	RS42	SMWMP	SWMP Qualifier	Other
pH		8.0	7.9		
F	mg/L	-	0.57		
SO <sub>4</sub>	mg/L	2150	910	>	2884 (gypsum model)
Al	mg/L	1.68	0.073		
Sb	mg/L	0.003	0.012		
As	mg/L	0.71	0.053		
Ba	mg/L	0.19	0.035	>	
Be	mg/L	0.0002	0.00001	>	
B	mg/L	0.76	0.46	>	
Cd	mg/L	0.00018	0.000051		
Cr	mg/L	0.0015	0.0032	>	
Co	mg/L	0.052	0.00031		
Cu	mg/L	0.092	0.0065	>	0.04 (tenorite model)
Fe	mg/L	0.81	0.012		
Pb	mg/L	0.0528	0.0011		
Mn	mg/L	0.75	0.017		
Hg	µg/L	0.006	0.03		
Mo	mg/L	0.0051	0.021	>	
Ni	mg/L	0.86	0.021	>	
Se	mg/L	0.0029	0.0077	>	0.02 (gypsum sequestration)
Ag	mg/L	0.0007	0.00005		
Tl	mg/L	0.00002	0.00005		
V	mg/L	-	0.003		
Zn	mg/L	0.09	0.0089		

Source:G:\PolyMet Mining\1UP005.01\_Northmet\_project\_2004\Testwork\2010-07\_SWMP\4.Interpretations\SMWMP\_Graphs\_1UP005001\_SJD.ver00.xlsx]

## 5 Conclusions

The Sequential Meteoric Water Mobility Procedure (SMWMP) performed to evaluate solubility constraints for Category 1 waste rock indicated the following:

- Leachates from low sulfur waste rock are expected to be basic with pH near 8.
- Leaching of Ag, Al, As, Be, Cd, Co, F, Fe, Hg, Mn, P, Pb, Sb, Si, Tl, V and Zn are better defined.
- Solubility of Ba, Cu, Se and SO<sub>4</sub> were not constrained in the procedure but concentrations are probably limited by secondary minerals.
- Leaching of B, Mo, Ni and Cr were not constrained by the procedure.

Attachments

Attachment 1  
Composite Preparation

## CAPPING CONCENTRATION SAMPLES

Richard Patelke-PolyMet

Revised, January, 2011

### A) SAMPLE SELECTION PROCESS

Concepts for the use of the “capping concentration” samples are covered in memos by SRK.

The goal was obtain at least 80 pounds for each composite. Sample selection followed this sequence:

- Using block model data, the minimum, average, and maximum for copper and nickel were calculated for six subsets of Waste Rock Category 1 blocks, those with sulfur % values (not ranges or averages, but actual values) of 0.02, 0.04, 0.06, 0.08, 0.10, and 0.12.
- The assay data base was sorted down to low sulfur samples with coarse reject material that was available and accessible. Material was all selected from the 2005 drilling, which is the oldest available, and therefore has a better chance of being slightly oxidized.
- Samples were identified based first on sulfur, then copper and nickel. Weighted averages were checked based on expected sample weights.
- Samples were pulled from storage, if available, weighed, and the weighted average was recalculated for sulfur, copper, nickel.
- This was repeated until sufficient sample was found (89 to 127 lbs).
- No sample splitting was done at PolyMet.
- Samples were shipped in buckets and plastic bags via UPS to SGS / CEMI in Vancouver for compositing, and a split from each was sent to ALS-Chemex in Vancouver for analysis.
- Once samples were proved to be of “correct” chemistry, testing at SGS / CEMI proceeded, as detailed by SRK.



## B) TABLES ATTACHED

Sample listing, with DDH, from, to, length, rocktype, unit, and weights

Calculated values vs. assayed values for each composite-elements above detection limits and mentioned in Steve Day memo to PolyMet on January 2, 2011

Values, where available, for assayed elements mentioned in Steve Day memo to PolyMet on January 2, 2011, where values are at or near detection limits. Boron, Chlorine, Fluorine, Selenium, and Silicon are not tested with this assay method (ALS-Chemex ME-ICP61). Thallium and Uranium were previously (2005) not tested by this method, but are now (2010).

## C) MAP ATTACHED

Map showing collar locations of drill holes supplying sample to this project, with APA mine pit outlines.







POLYMET / SRK CAPPING CONCENTRATION SAMPLES-CALCULATED VALUES VS. ASSAYED VALUES																					
		TARGET COPPER	TARGET NICKEL	TARGET SULFUR	S% ME- ICP61	S% LECO	CU%	NI%	CO_PPM	ZN_PPM	BA_PPM	CR_PPM	V_PPM	AL%	CA%	FE%	MG%	MN_PPM	K%	NA%	P_PPM
CAPCON 2	WEIGHTED AVERAGE	0.012	0.029	0.02	0.02		0.013	0.024	42	64	92	159	71	9.29	6.96	5.54	3.69	731	0.19	1.92	292
CAPCON 2	ASSAY ON COMPOSITE				0.02	0.02	0.013	0.025	45	75	100	206	76	9.32	7.31	5.67	3.47	800	0.22	1.99	300
CAPCON 4	WEIGHTED AVERAGE	0.021	0.026	0.04	0.04		0.021	0.023	50	89	130	152	119	9.22	6.40	7.56	4.19	988	0.36	1.98	538
CAPCON 4	ASSAY ON COMPOSITE				0.04	0.04	0.022	0.024	53	105	150	190	132	10.45	6.79	8.16	4.55	1095	0.41	2.06	580
CAPCON 6	WEIGHTED AVERAGE	0.028	0.026	0.06	0.06		0.028	0.026	50	87	135	148	109	9.65	6.50	7.23	4.25	928	0.37	1.98	592
CAPCON 6	ASSAY ON COMPOSITE				0.06	0.05	0.030	0.028	53	95	150	169	112	9.44	6.81	7.39	4.01	999	0.37	2.06	620
CAPCON 8	WEIGHTED AVERAGE	0.035	0.027	0.08	0.08		0.035	0.025	52	99	136	168	143	9.16	6.25	7.70	4.09	994	0.37	1.97	658
CAPCON 8	ASSAY ON COMPOSITE				0.09	0.07	0.037	0.026	54	103	160	195	147	10.05	6.92	8.18	4.18	1095	0.41	2.13	710
CAPCON 10	WEIGHTED AVERAGE	0.04	0.027	0.1	0.10		0.041	0.026	53	102	151	185	140	9.16	6.18	8.26	4.26	1055	0.43	1.93	712
CAPCON 10	ASSAY ON COMPOSITE				0.12	0.1	0.046	0.028	59	110	150	216	145	9.44	6.51	8.48	4.12	1125	0.44	1.98	720
CAPCON 12	WEIGHTED AVERAGE	0.05	0.028	0.12	0.12		0.049	0.031	56	106	146	139	147	9.00	6.01	8.81	4.56	1108	0.40	1.89	702
CAPCON 12	ASSAY ON COMPOSITE				0.13	0.11	0.057	0.033	59	112	150	164	152	9.18	6.22	9.04	4.48	1180	0.41	1.91	670
METHOD CODE-CHEMEX					ME-ICP61	S-IR08	ME-ICP61	ME-ICP61	ME-ICP61	ME-ICP61	ME-ICP61	ME-ICP61	ME-ICP61	ME-ICP61	ME-ICP61	ME-ICP61	ME-ICP61	ME-ICP61	ME-ICP61	ME-ICP61	ME-ICP61
DETECTION LIMIT					0.01	0.01	1	1	1	2	10	1	1	0.01	0.01	0.01	0.01	5	0.01	0.01	10
ME-ICP61 IS FOUR ACID DIGESTION FOLLOWED BY ICP-AES																					
S-IR08 IS TOTAL SULFUR BY LECO FURNACE																					
"WEIGHTED AVERAGE" IS VALUE CALCULATED FOR COMPOSITE FROM INDIVIDUAL WEIGHED SAMPLES																					

SAMPLES REFERENCED IN STEVE DAY MEMO THAT ARE LARGELY BELOW ASSAY DETECTION LIMITS

	ELEMENT	DETECTION LIMIT	TOTAL NUMBER SAMPLES IN COMPOSITE	TOTAL BELOW DETECTION LIMIT	UNWEIGHTED AVERAGE OF VALUES ABOVE DETECTION LIMIT	SINGLE ASSAY VALUE FROM COMPOSITE USED IN TEST
CAPCON 2	Arsenic	5 ppm	9	6	9	<5
	Antimony	5 ppm	9	9	NA	<5
	Silver	0.5 ppm	9	8	0.6	<0.5
	Beryllium	0.5 ppm	9	9	NA	<0.5
	Cadmium	0.5 ppm	9	9	NA	<0.5
	Lead	2 ppm	9	2	7	<2
	Molybdenum	1 ppm	9	8	3	<1
	Thallium	10 ppm	9	NS	NS	10
	Uranium	10 ppm	9	NS	NS	<10
CAPCON 4	Arsenic	5 ppm	15	10	6	<5
	Antimony	5 ppm	15	14	5	6
	Silver	0.5 ppm	15	14	0.5	<0.5
	Beryllium	0.5 ppm	15	6	0.6	0.5
	Cadmium	0.5 ppm	15	14	0.6	<0.5
	Lead	2 ppm	15	4	6	7
	Molybdenum	1 ppm	15	10	1	1
	Thallium	10 ppm	15	NS	NS	10
	Uranium	10 ppm	15	NS	NS	<10
CAPCON 6	Arsenic	5 ppm	10	5	6	<5
	Antimony	5 ppm	10	9	8	<5
	Silver	0.5 ppm	10	10	NA	<0.5
	Beryllium	0.5 ppm	10	4	0.7	0.5
	Cadmium	0.5 ppm	10	10	NA	<0.5
	Lead	2 ppm	10	2	5	2
	Molybdenum	1 ppm	10	7	1	<1
	Thallium	10 ppm	10	NS	NS	10
	Uranium	10 ppm	10	NS	NS	<10
CAPCON 8	Arsenic	5 ppm	11	7	11	10
	Antimony	5 ppm	11	11	NA	<5
	Silver	0.5 ppm	11	11	NA	<0.5
	Beryllium	0.5 ppm	11	3	0.7	0.6
	Cadmium	0.5 ppm	11	10	0.9	<0.5
	Lead	2 ppm	11	1	7	8
	Molybdenum	1 ppm	11	8	1	1
	Thallium	10 ppm	11	NS	NS	10
	Uranium	10 ppm	11	NS	NS	<10

	ELEMENT	DETECTION LIMIT	TOTAL NUMBER SAMPLES IN COMPOSITE	TOTAL BELOW DETECTION LIMIT	UNWEIGHTED AVERAGE OF VALUES ABOVE DETECTION LIMIT	SINGLE ASSAY VALUE FROM COMPOSITE USED IN TEST
CAPCON 10	Arsenic	5 ppm	15	11	13	13
	Antimony	5 ppm	15	14	7	<5
	Silver	0.5 ppm	15	14	0.5	0.6
	Beryllium	0.5 ppm	15	6	1	0.6
	Cadmium	0.5 ppm	15	15	NA	<0.5
	Lead	2 ppm	15	2	7	10
	Molybdenum	1 ppm	15	9	1	<1
	Thallium	10 ppm	15	NS	NS	<10
	Uranium	10 ppm	15	NS	NS	<10
CAPCON 12	Arsenic	5 ppm	14	7	9	<5
	Antimony	5 ppm	14	13	5	<5
	Silver	0.5 ppm	14	14	NA	<0.5
	Beryllium	0.5 ppm	14	4	0.7	0.6
	Cadmium	0.5 ppm	14	14	NA	<0.5
	Lead	2 ppm	14	10	5	5
	Molybdenum	1 ppm	14	10	1	<1
	Thallium	10 ppm	14	NS	NS	<10
	Uranium	10 ppm	14	NS	NS	<10
	NS = NOT SAMPLED					
	NA = NOT AVAILABLE					

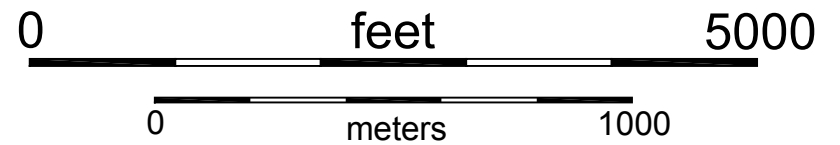
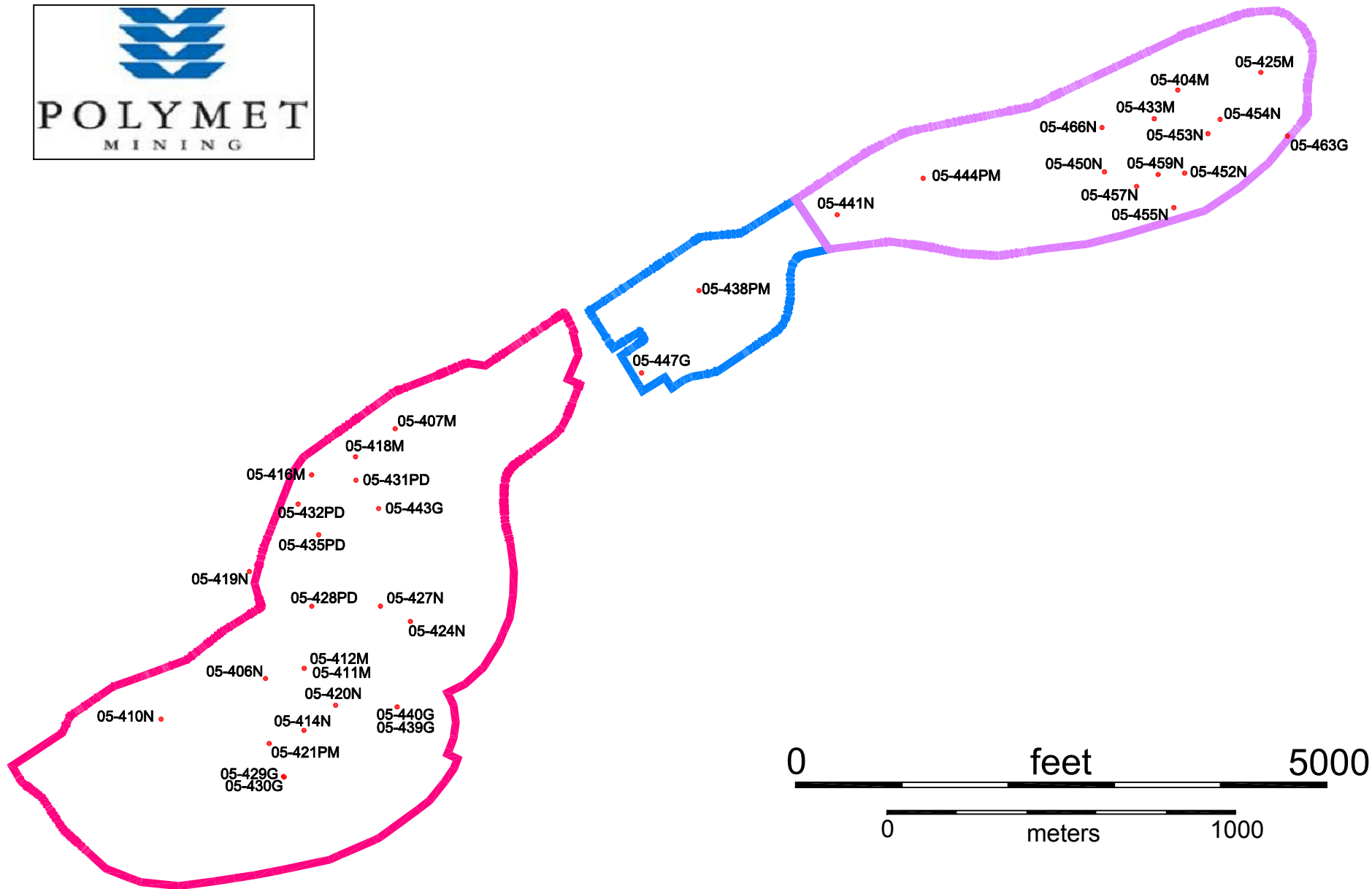

DRILL HOLES FOR "CAPCON" SAMPLES  
COLLAR LOCATIONS  
RLP-JANUARY 2011



Attachment 2  
Graphs of SMWMP Results

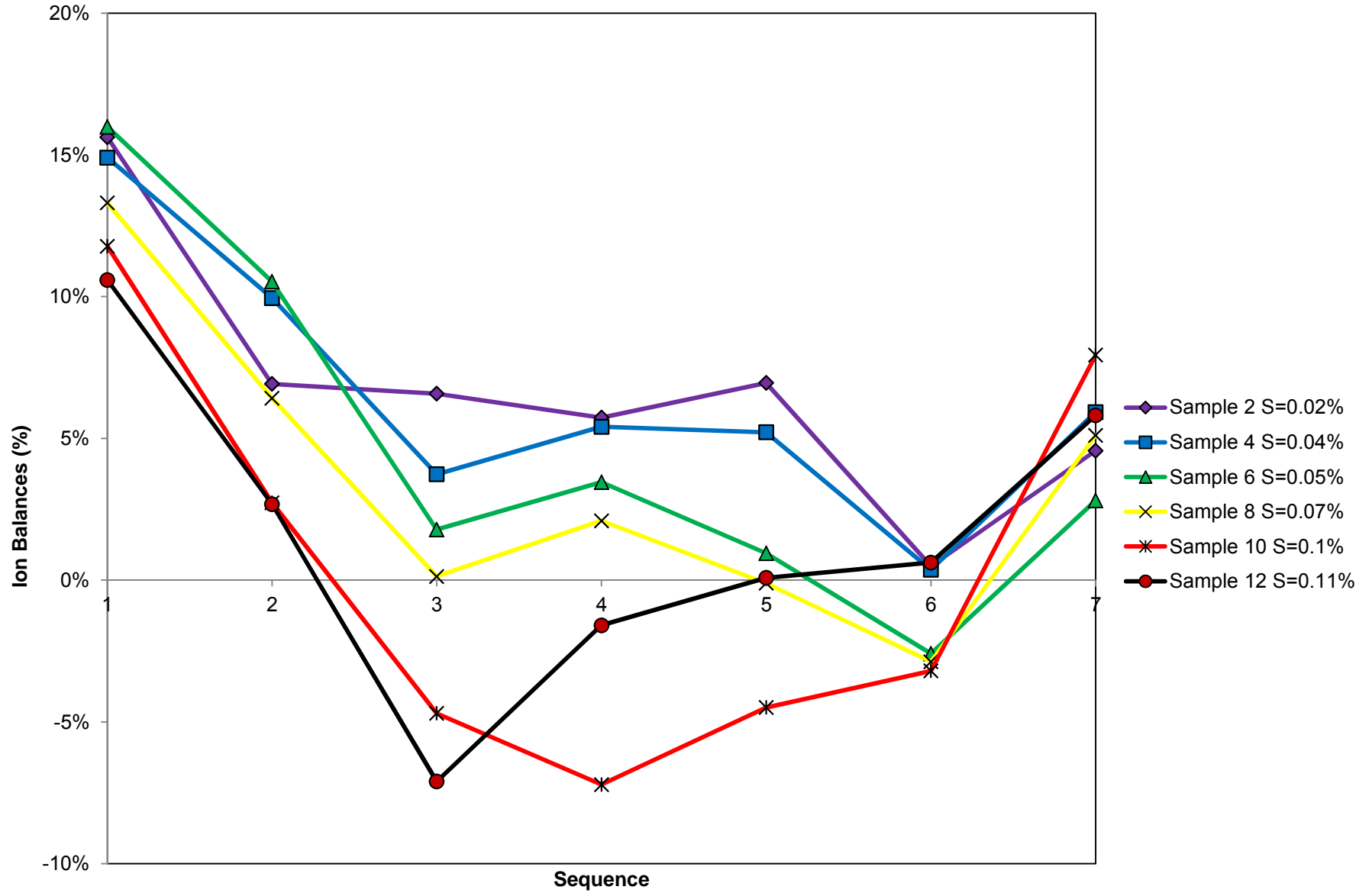

G:\PolyMet Mining\1UP005.01\_Northmet\_project\_2004\Testwork\2010-07\_SWMP\4.Interpretations\[SMWMP\_Graphs\_1UP005001\_SJD.ver00.xlsx]

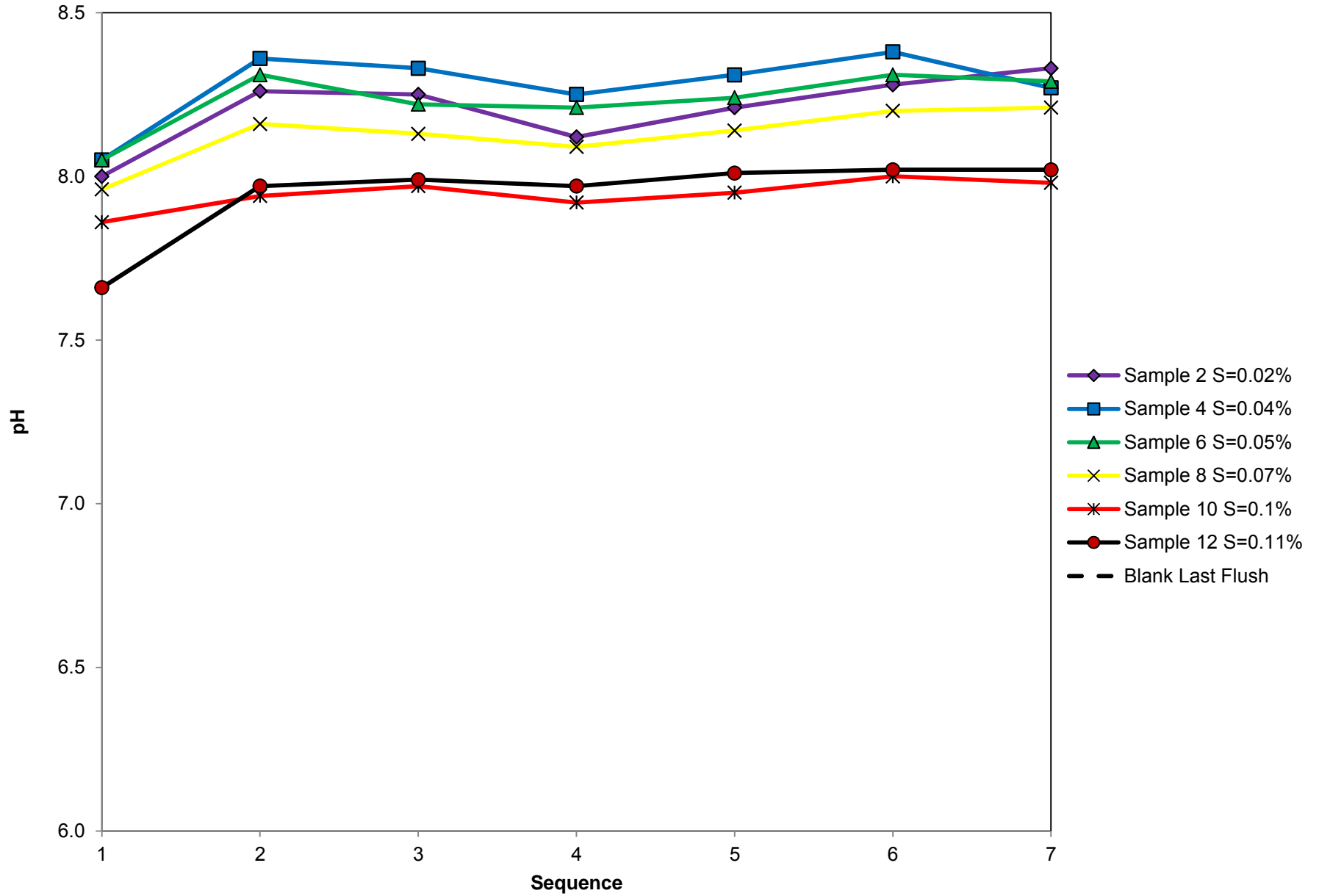

G:\PolyMet Mining\1UP005.01\_Northmet\_project\_2004\Testwork\2010-07\_SWMP\4.Interpretations\[SMWMP\_Graphs\_1UP005001\_SJD.ver00.xlsx]

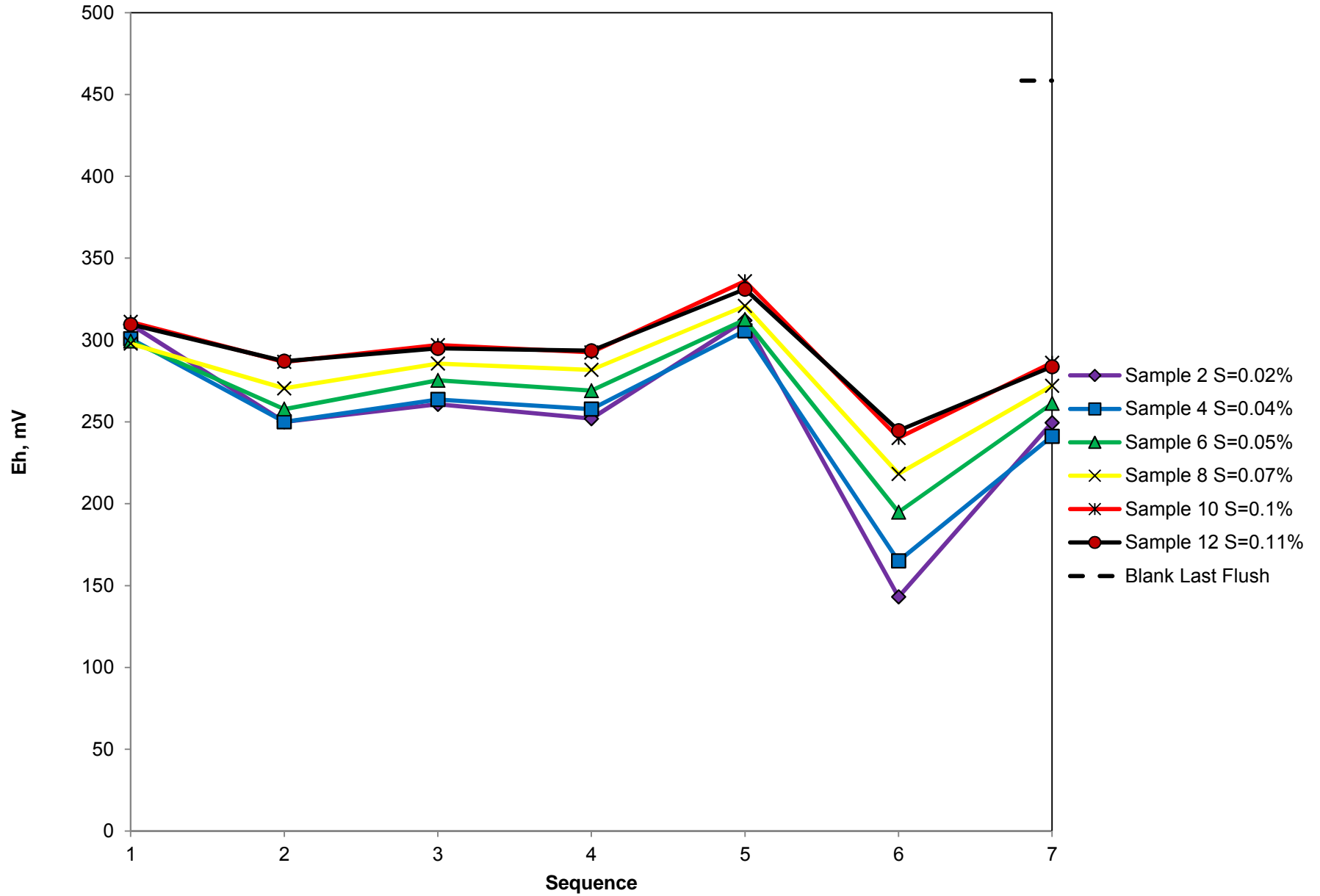

G:\PolyMet Mining\1UP005.01\_Northmet\_project\_2004\Testwork\2010-07\_SWMP\4.Interpretations\[SMWMP\_Graphs\_1UP005001\_SJD.ver00.xlsx]

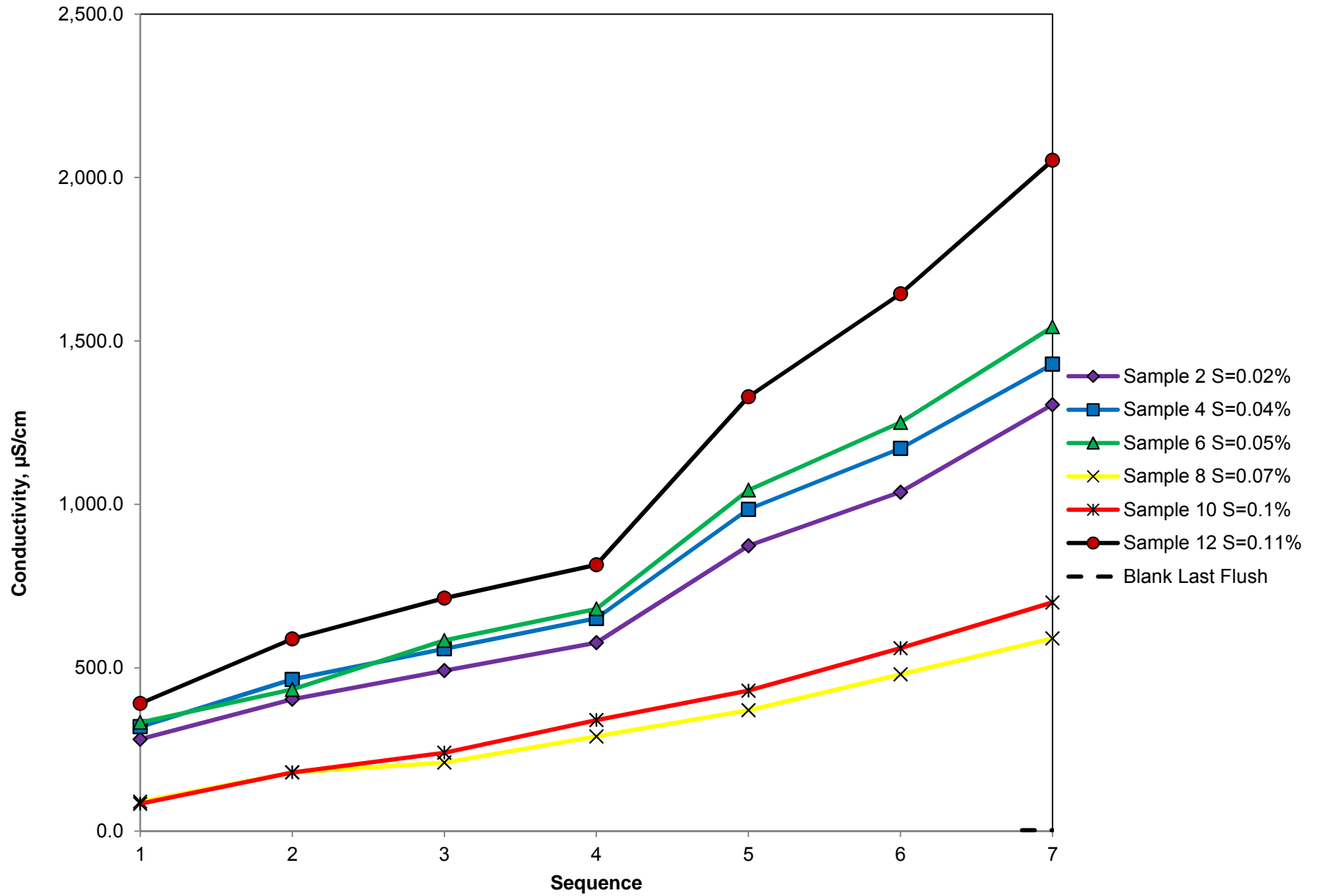

G:\PolyMet Mining\1UP005.01\_Northmet\_project\_2004\Testwork\2010-07\_SWMP\4.Interpretations\SMWMP\_Graphs\_1UP005001\_SJD.ver00.xlsx

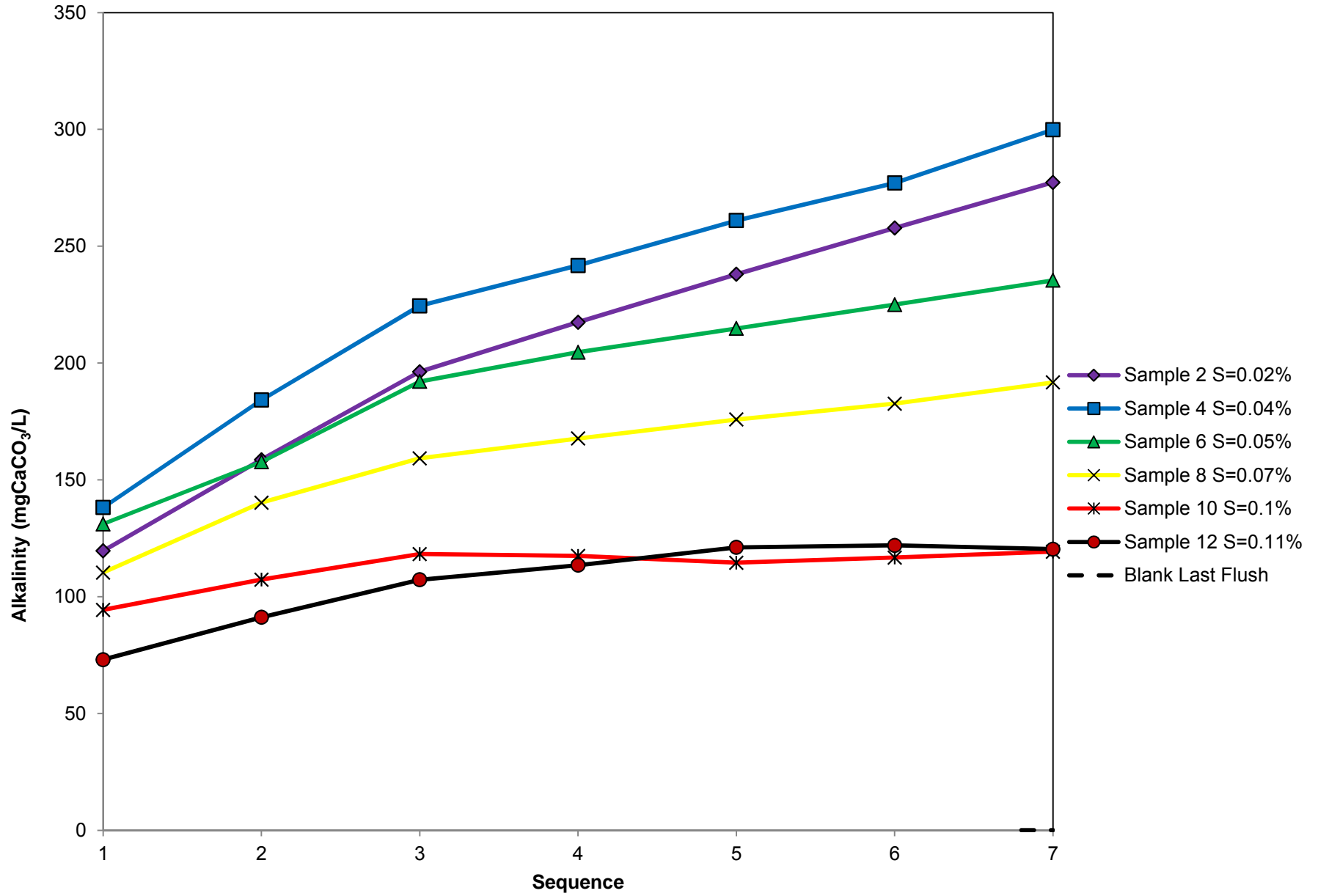

G:\PolyMet Mining\1UP005.01\_Northmet\_project\_2004\Testwork\2010-07\_SWMP\4.Interpretations\[SMWMP\_Graphs\_1UP005001\_SJD.ver00.xlsx]

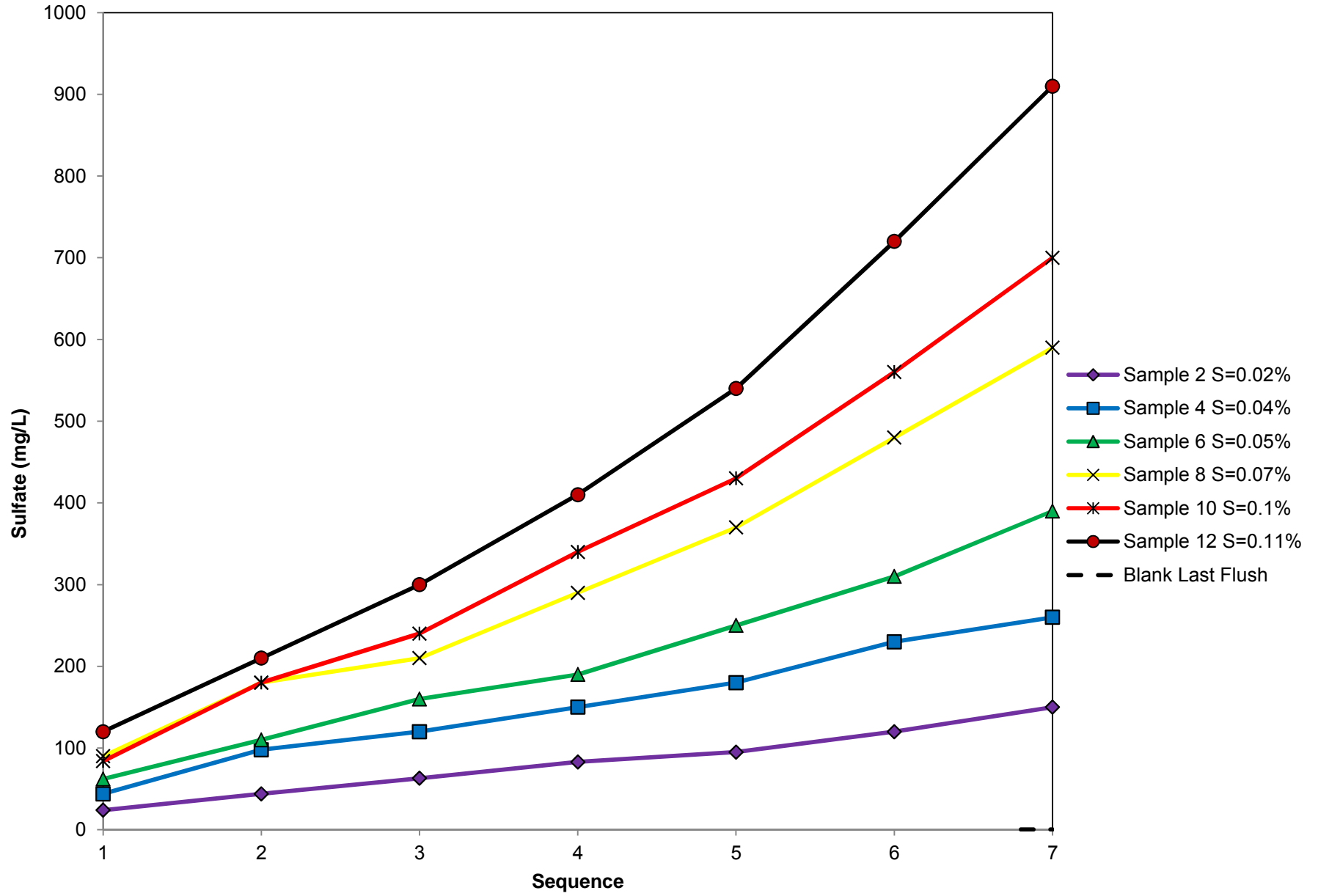

G:\PolyMet Mining\1UP005.01\_Northmet\_project\_2004\Testwork\2010-07\_SWMP\4.Interpretations\SMWMP\_Graphs\_1UP005001\_SJD.ver00.xlsx

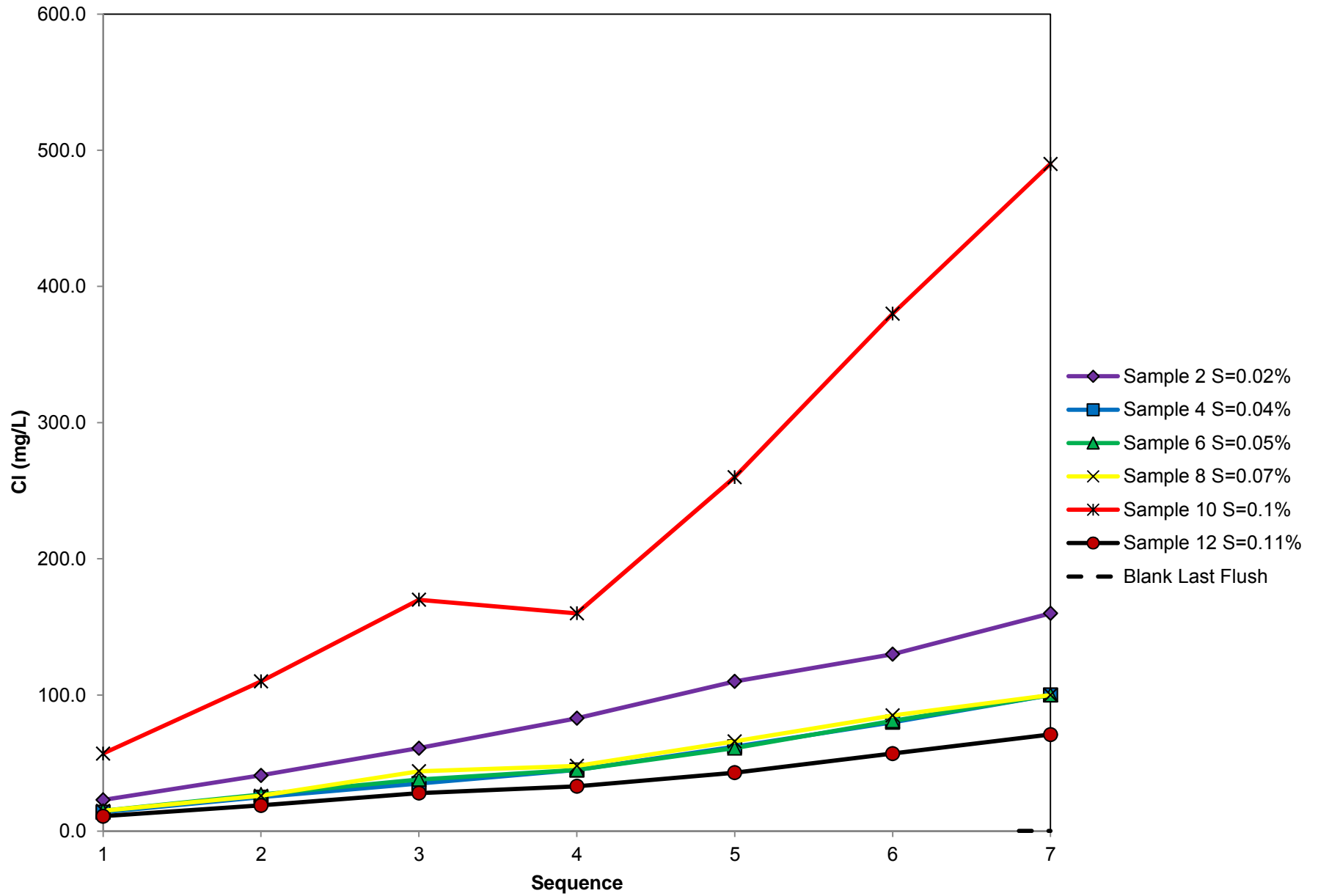

G:\PolyMet Mining\1UP005.01\_Northmet\_project\_2004\Testwork\2010-07\_SWMP\4.Interpretations\[SMWMP\_Graphs\_1UP005001\_SJD.ver00.xlsx]



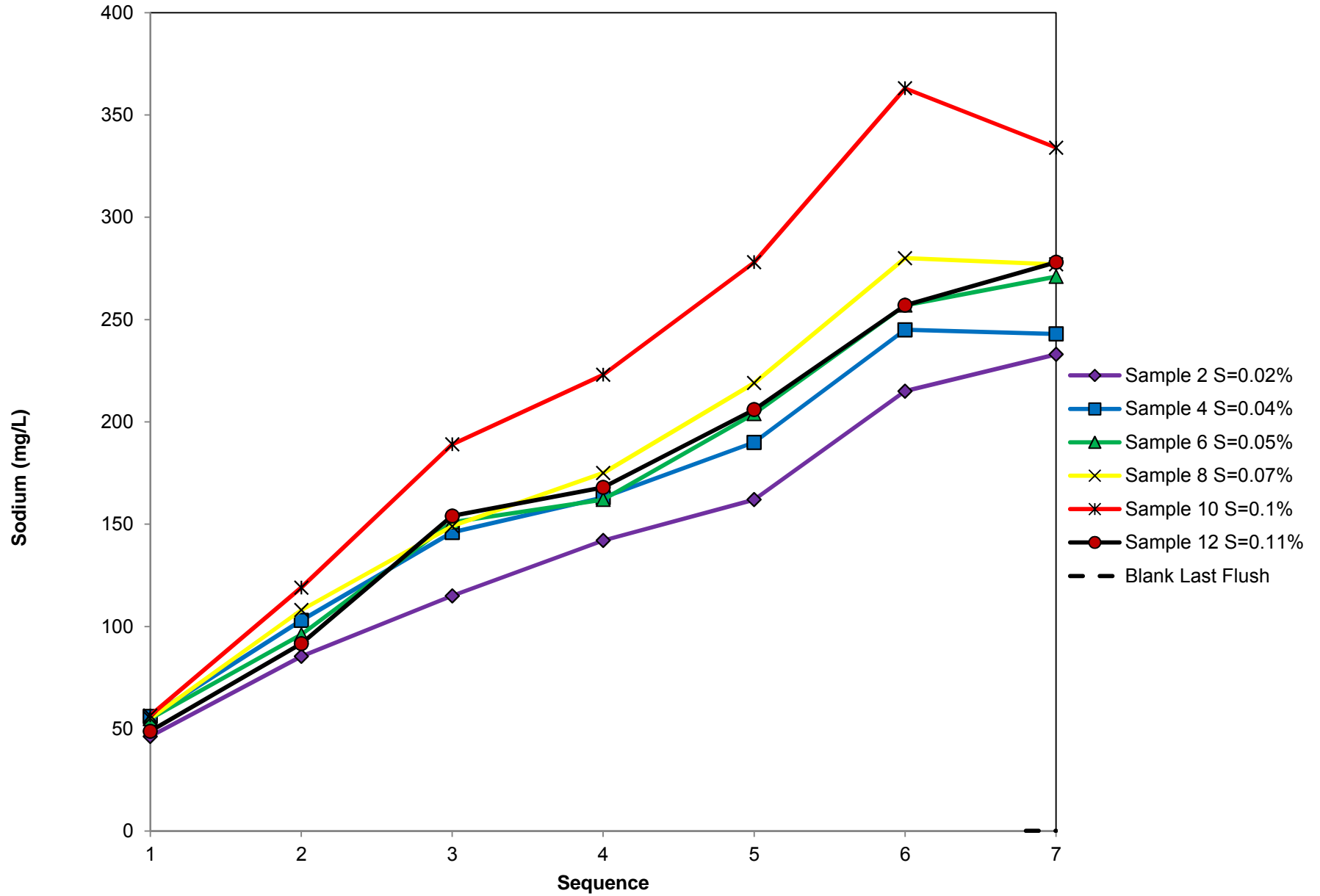

G:\PolyMet Mining\1UP005.01\_Northmet\_project\_2004\Testwork\2010-07\_SWMP\4.Interpretations\[SMWMP\_Graphs\_1UP005001\_SJD.ver00.xlsx]

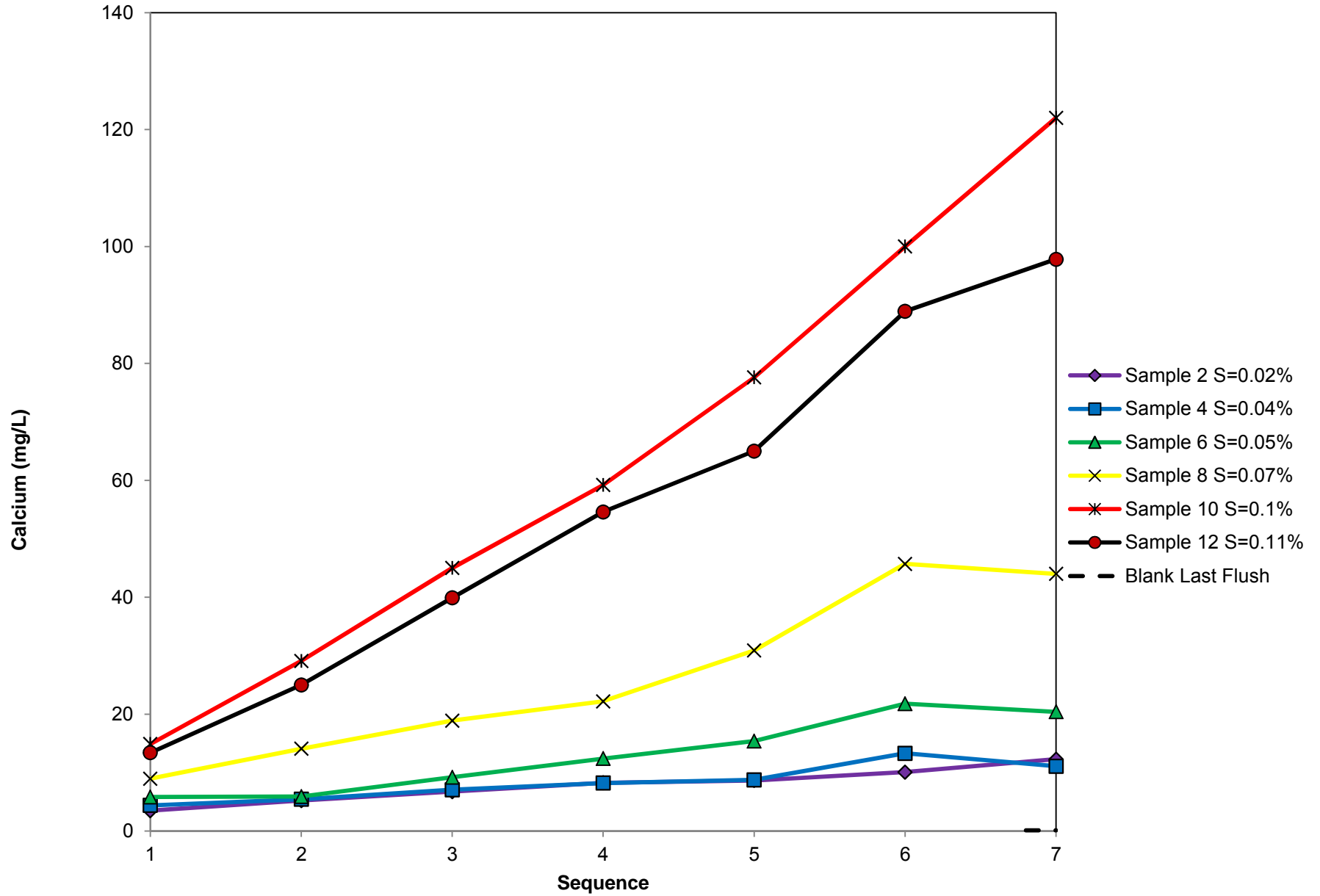

G:\PolyMet Mining\1UP005.01\_Northmet\_project\_2004\Testwork\2010-07\_SWMP\4.Interpretations\[SMWMP\_Graphs\_1UP005001\_SJD.ver00.xlsx]

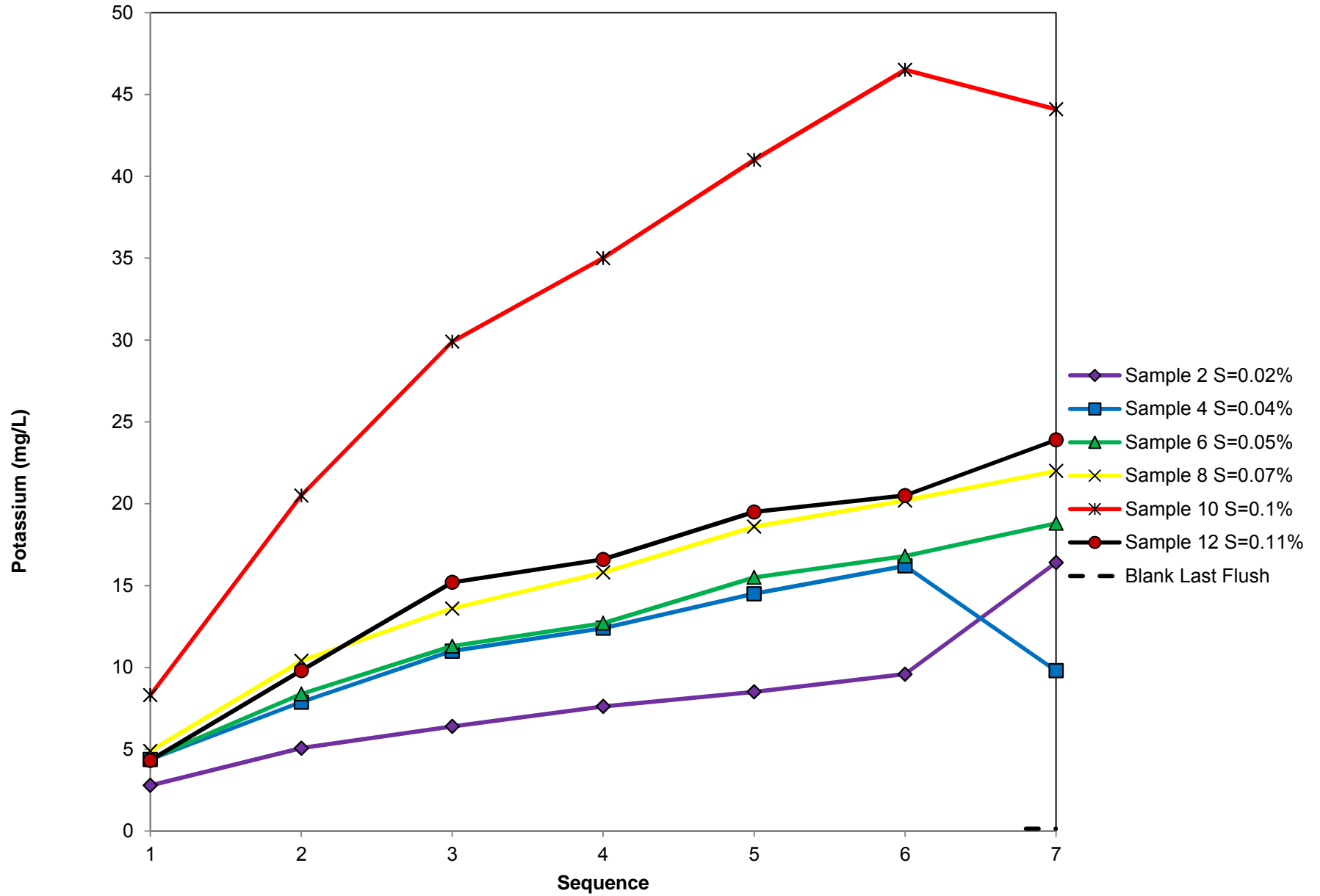

G:\PolyMet Mining\1UP005.01\_Northmet\_project\_2004\Testwork\2010-07\_SWMP\4.Interpretations\SMWMP\_Graphs\_1UP005001\_SJD.ver00.xlsx

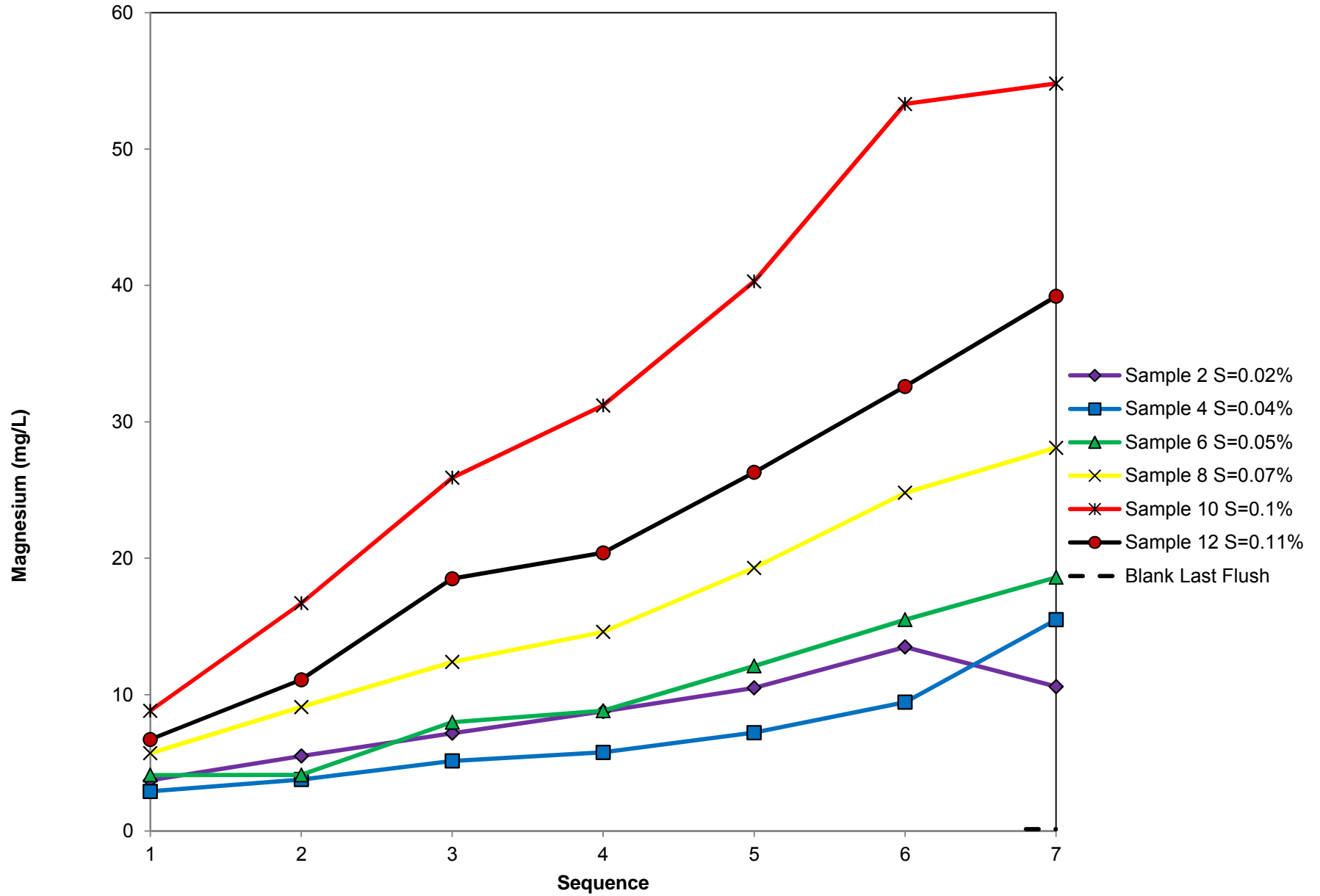

G:\PolyMet Mining\1UP005.01\_Northmet\_project\_2004\Testwork\2010-07\_SWMP\4.Interpretations\[SMWMP\_Graphs\_1UP005001\_SJD.ver00.xlsx]

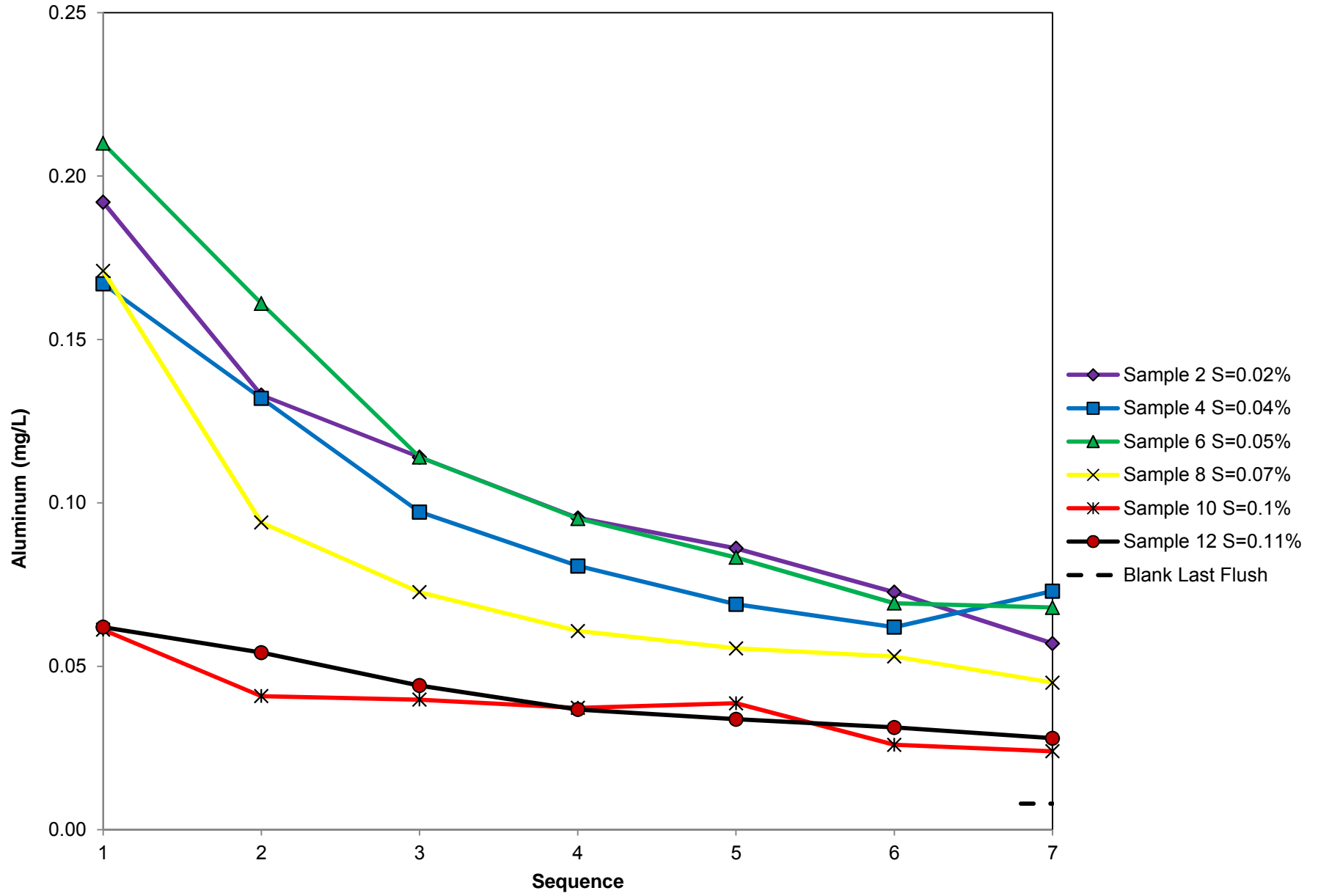

G:\PolyMet Mining\1UP005.01\_Northmet\_project\_2004\Testwork\2010-07\_SWMP\4.Interpretations\[SMWMP\_Graphs\_1UP005001\_SJD.ver00.xlsx]

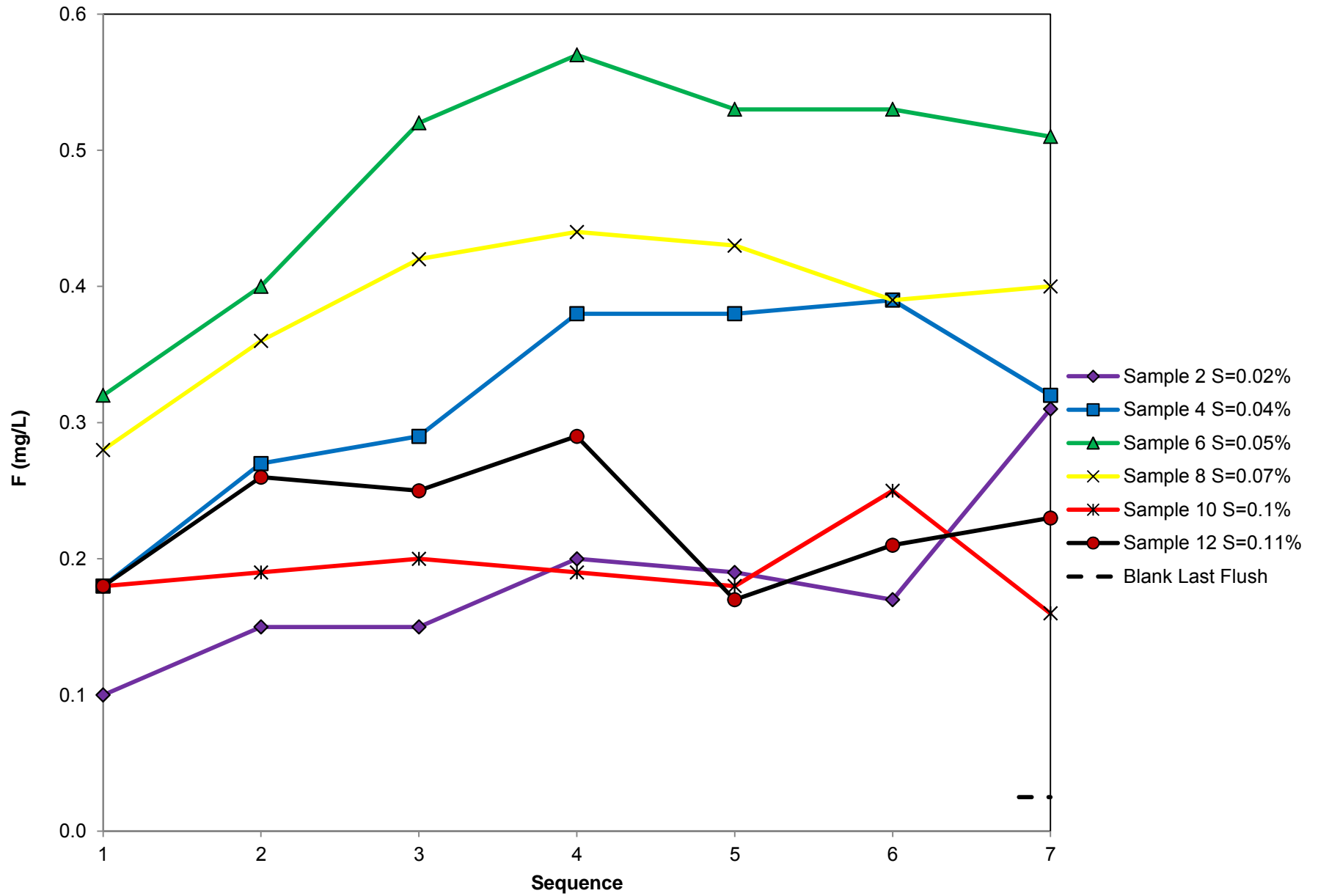

G:\PolyMet Mining\1UP005.01\_Northmet\_project\_2004\Testwork\2010-07\_SWMP\4.Interpretations\[SMWMP\_Graphs\_1UP005001\_SJD.ver00.xlsx]

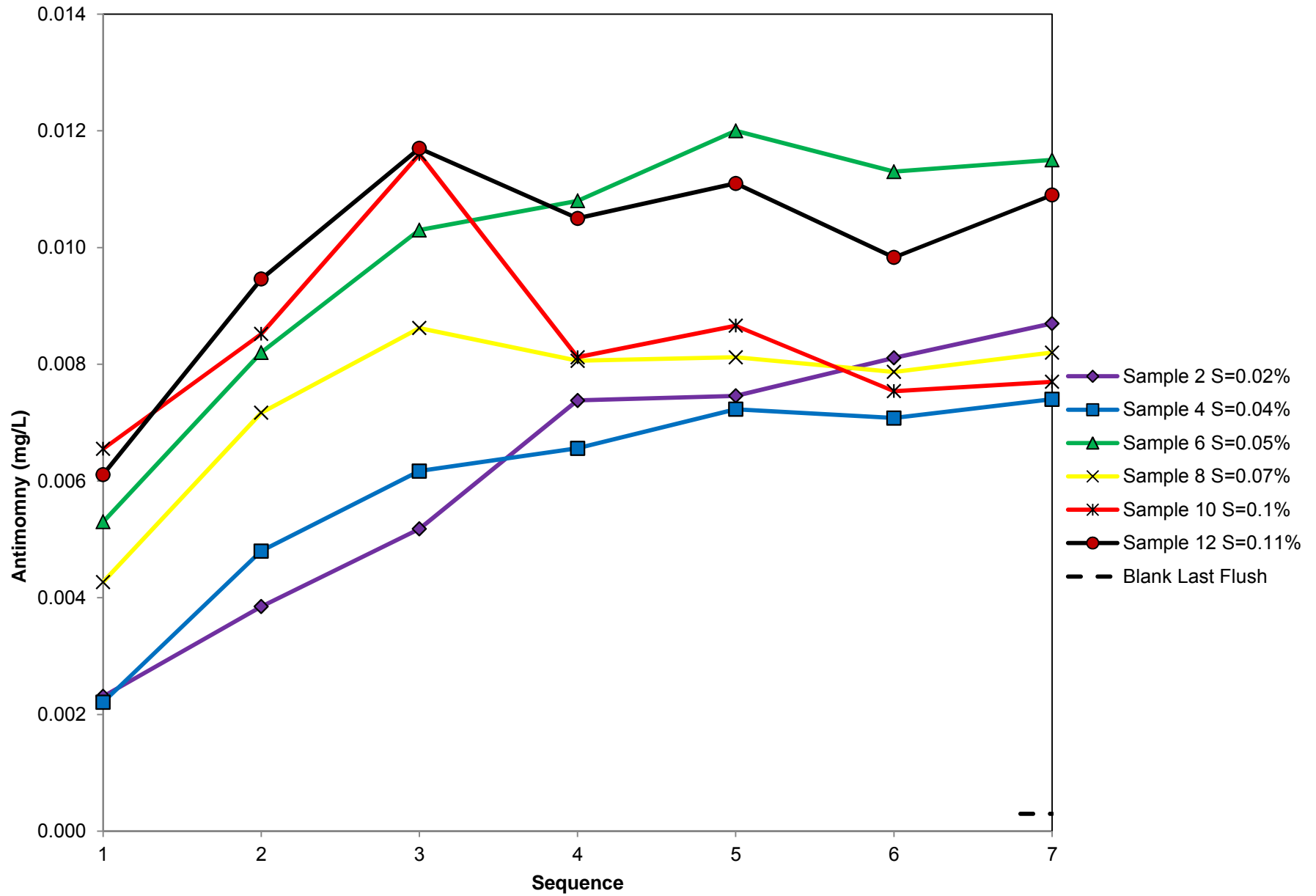

G:\PolyMet Mining\1UP005.01\_Northmet\_project\_2004\Testwork\2010-07\_SWMP\4.Interpretations\SMWMP\_Graphs\_1UP005001\_SJD.ver00.xlsx

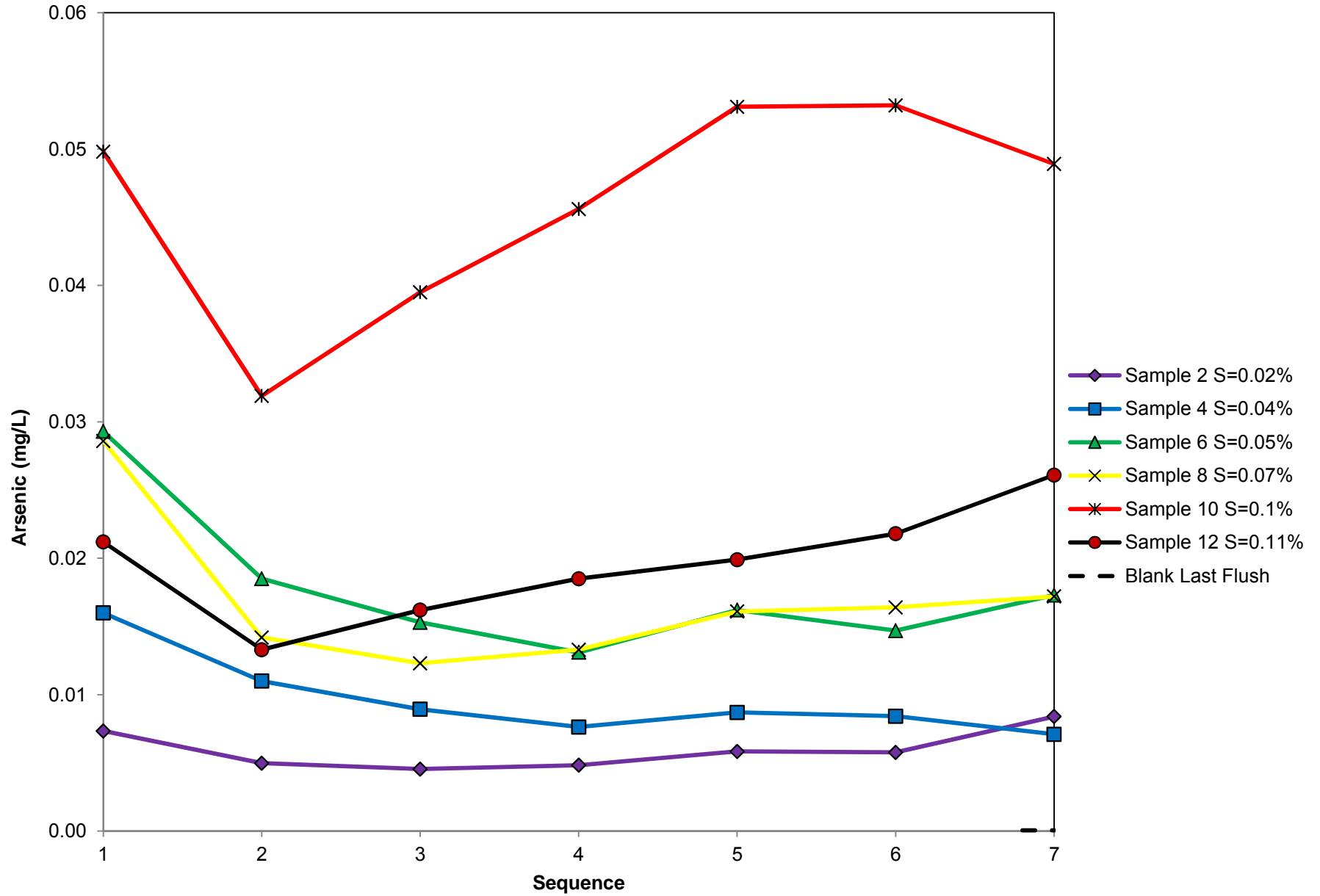

G:\PolyMet Mining\1UP005.01\_Northmet\_project\_2004\Testwork\2010-07\_SWMP\4.Interpretations\[SMWMP\_Graphs\_1UP005001\_SJD.ver00.xlsx]



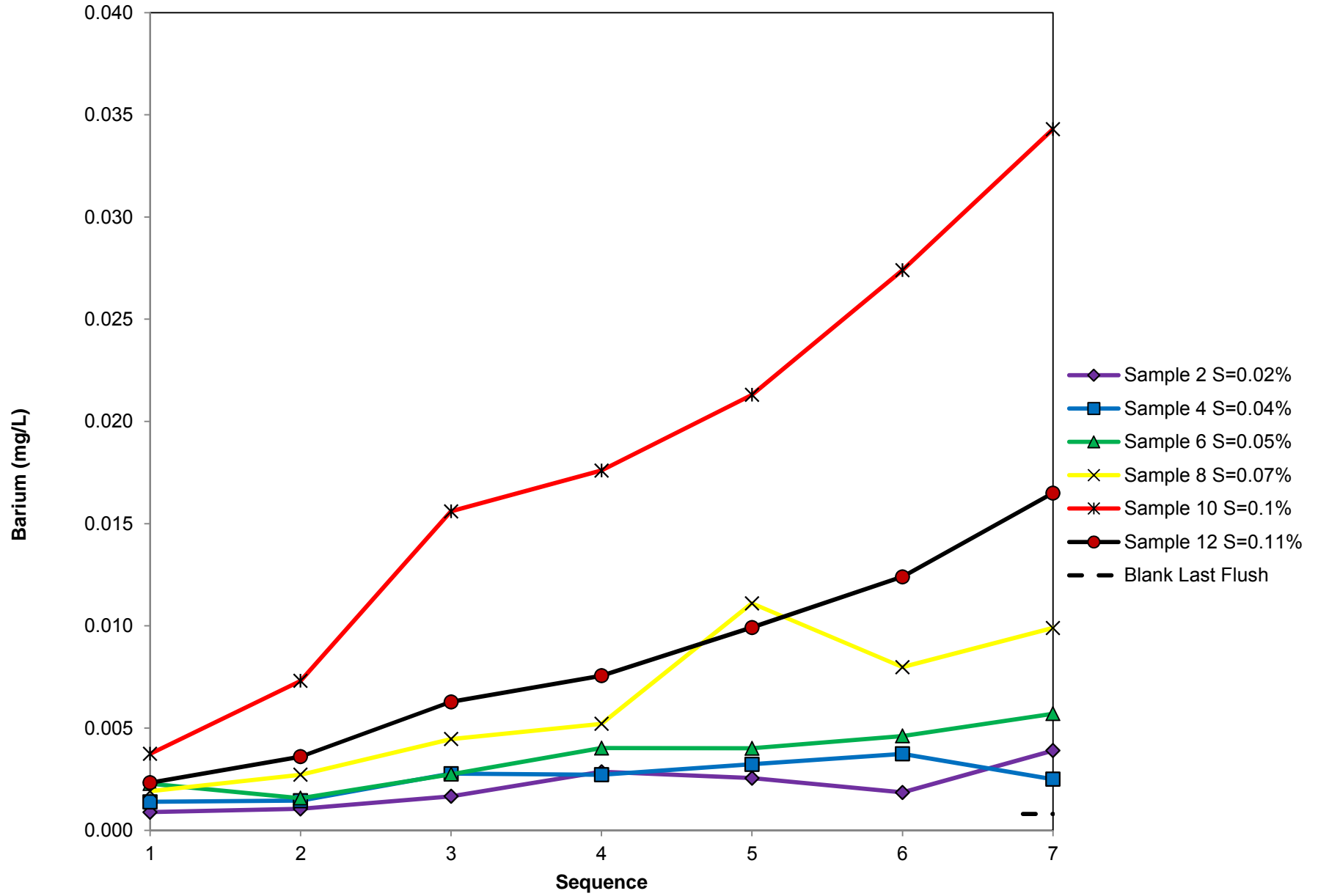

G:\PolyMet Mining\1UP005.01\_Northmet\_project\_2004\Testwork\2010-07\_SWMP\4.Interpretations\[SMWMP\_Graphs\_1UP005001\_SJD.ver00.xlsx]

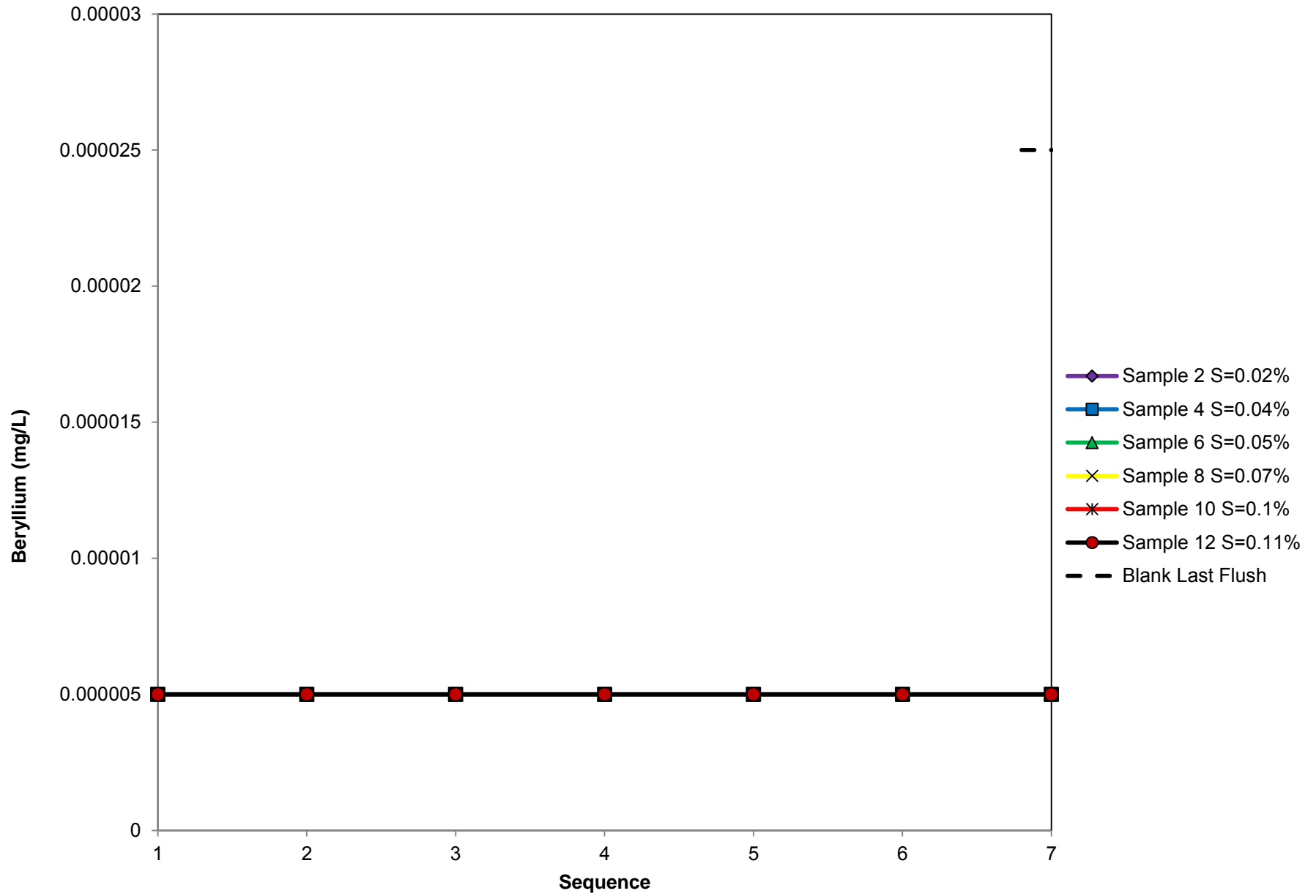

G:\PolyMet Mining\1UP005.01\_Northmet\_project\_2004\Testwork\2010-07\_SWMP\4.Interpretations\[SMWMP\_Graphs\_1UP005001\_SJD.ver00.xlsx]

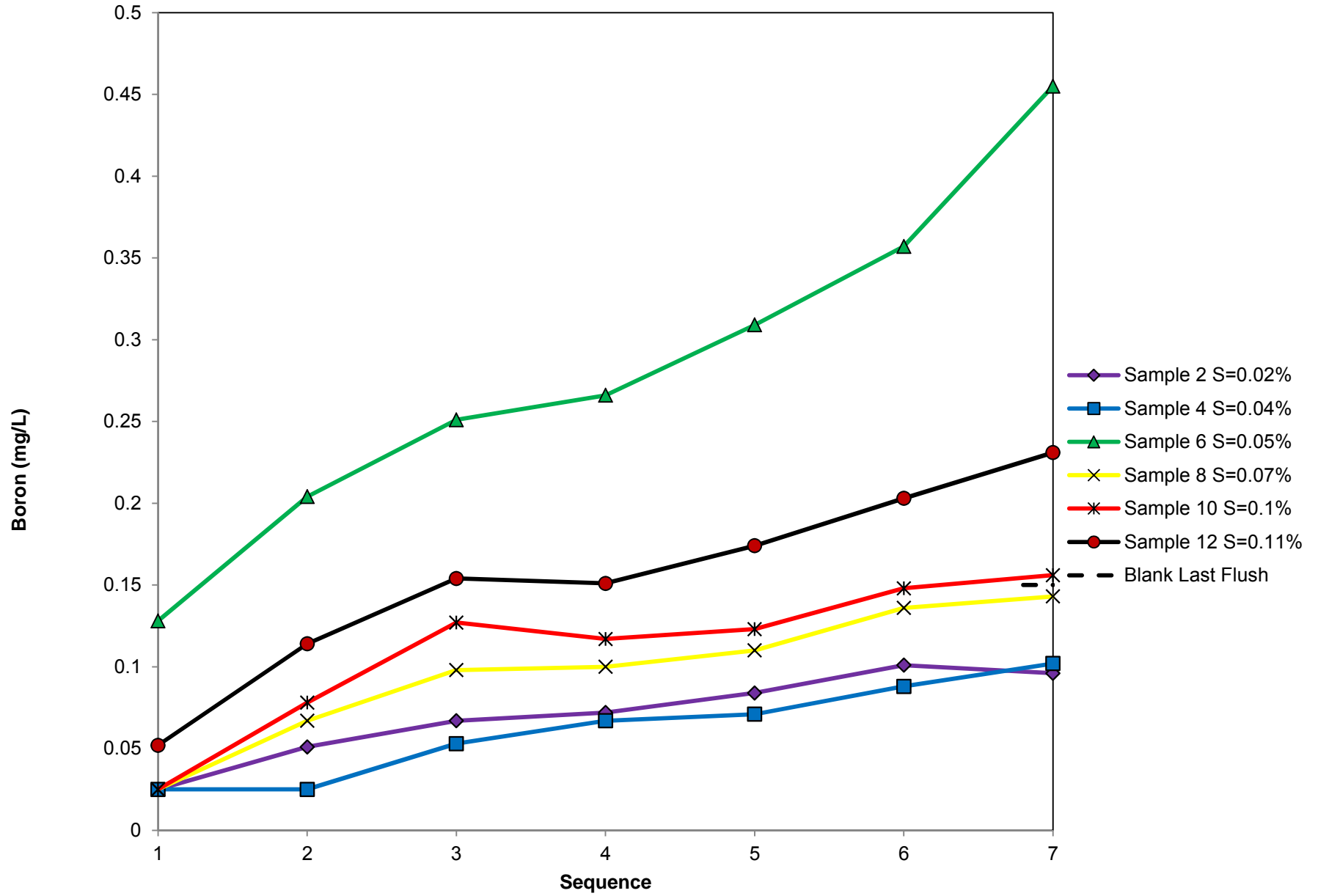

G:\PolyMet Mining\1UP005.01\_Northmet\_project\_2004\Testwork\2010-07\_SWMP\4.Interpretations\[SMWMP\_Graphs\_1UP005001\_SJD.ver00.xlsx]

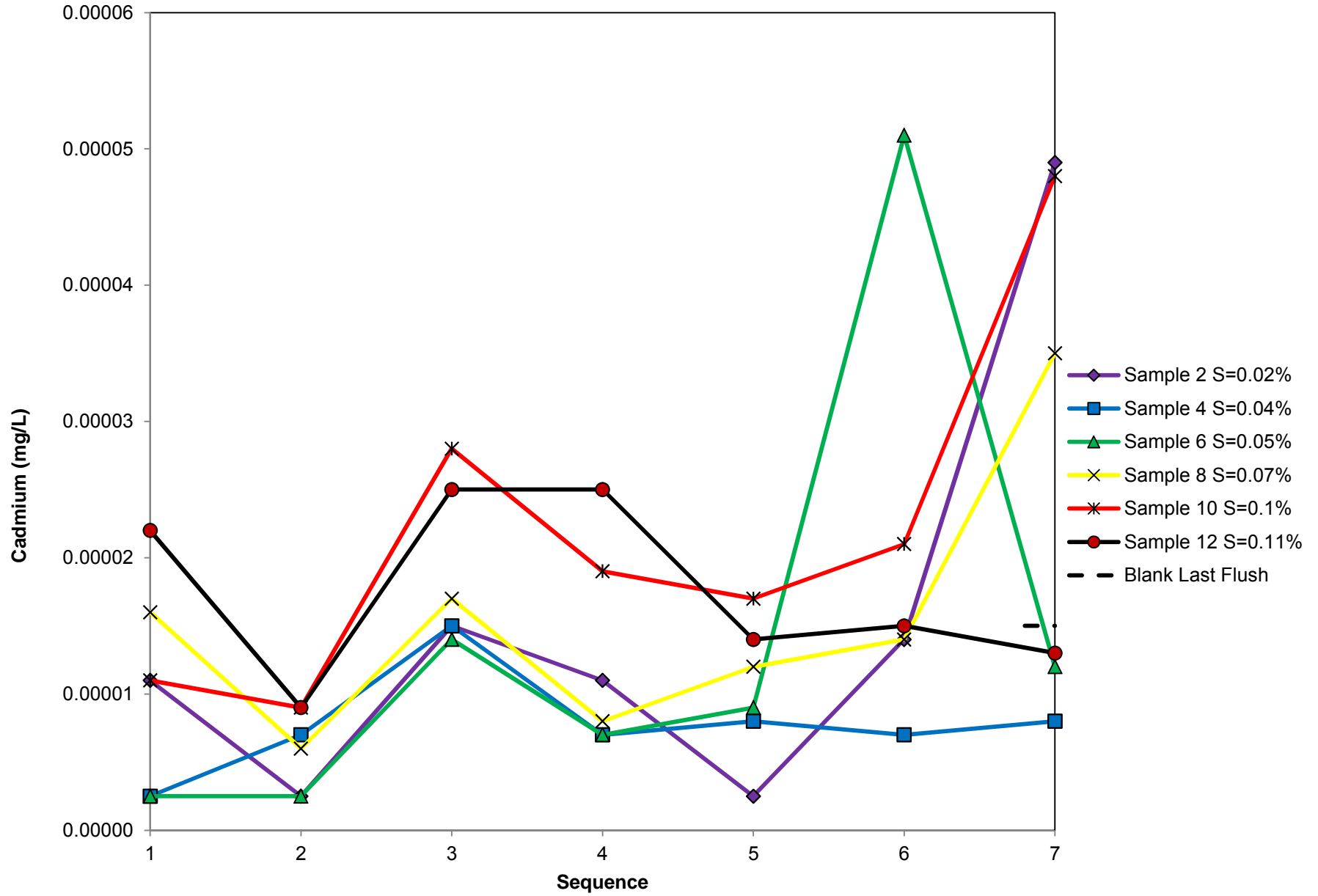

G:\PolyMet Mining\1UP005.01\_Northmet\_project\_2004\Testwork\2010-07\_SWMP\4.Interpretations\SMWMP\_Graphs\_1UP005001\_SJD.ver00.xlsx

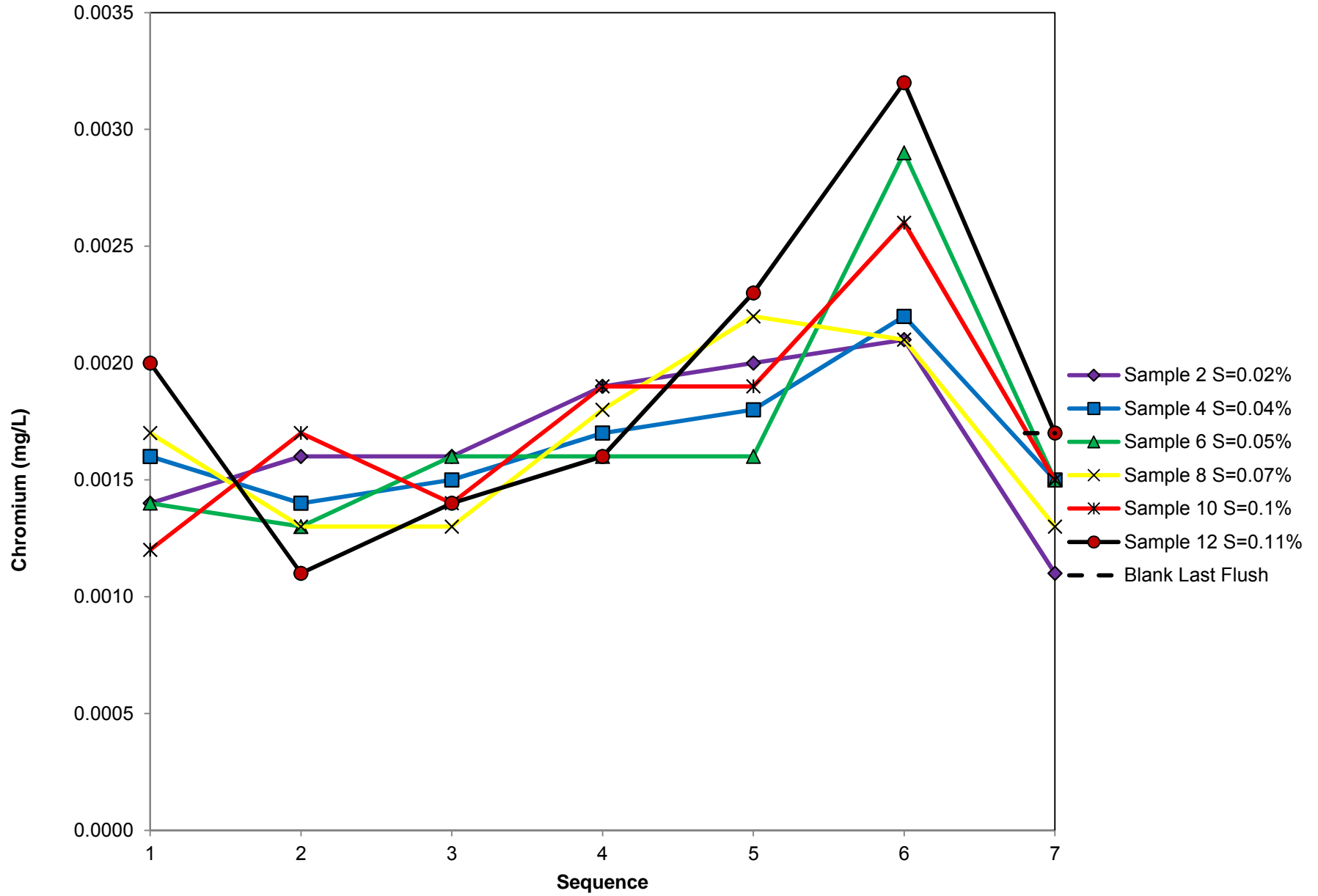

G:\PolyMet Mining\1UP005.01\_Northmet\_project\_2004\Testwork\2010-07\_SWMP\4.Interpretations\[SMWMP\_Graphs\_1UP005001\_SJD.ver00.xlsx]

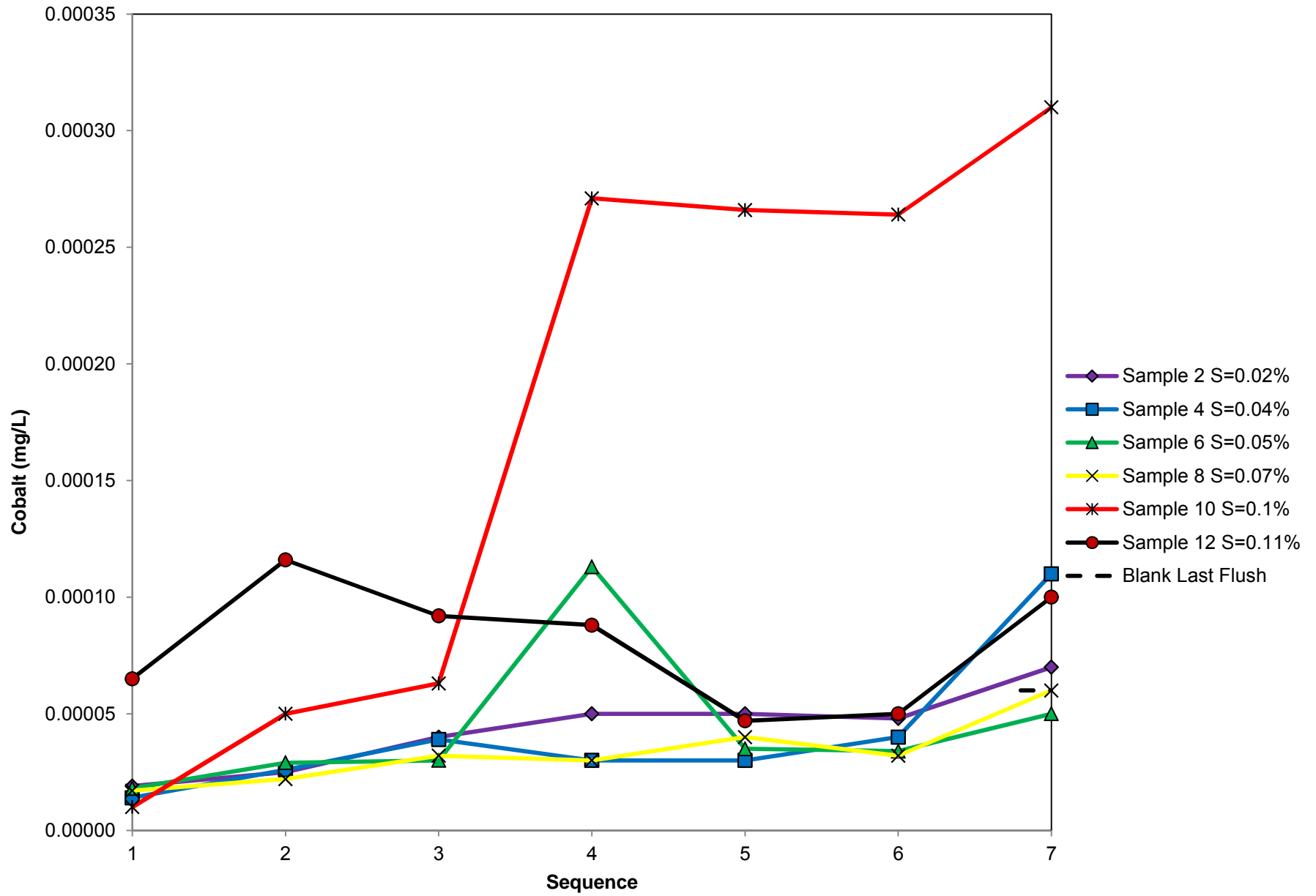

G:\PolyMet Mining\1UP005.01\_Northmet\_project\_2004\Testwork\2010-07\_SWMP\4.Interpretations\SMWMP\_Graphs\_1UP005001\_SJD.ver00.xlsx

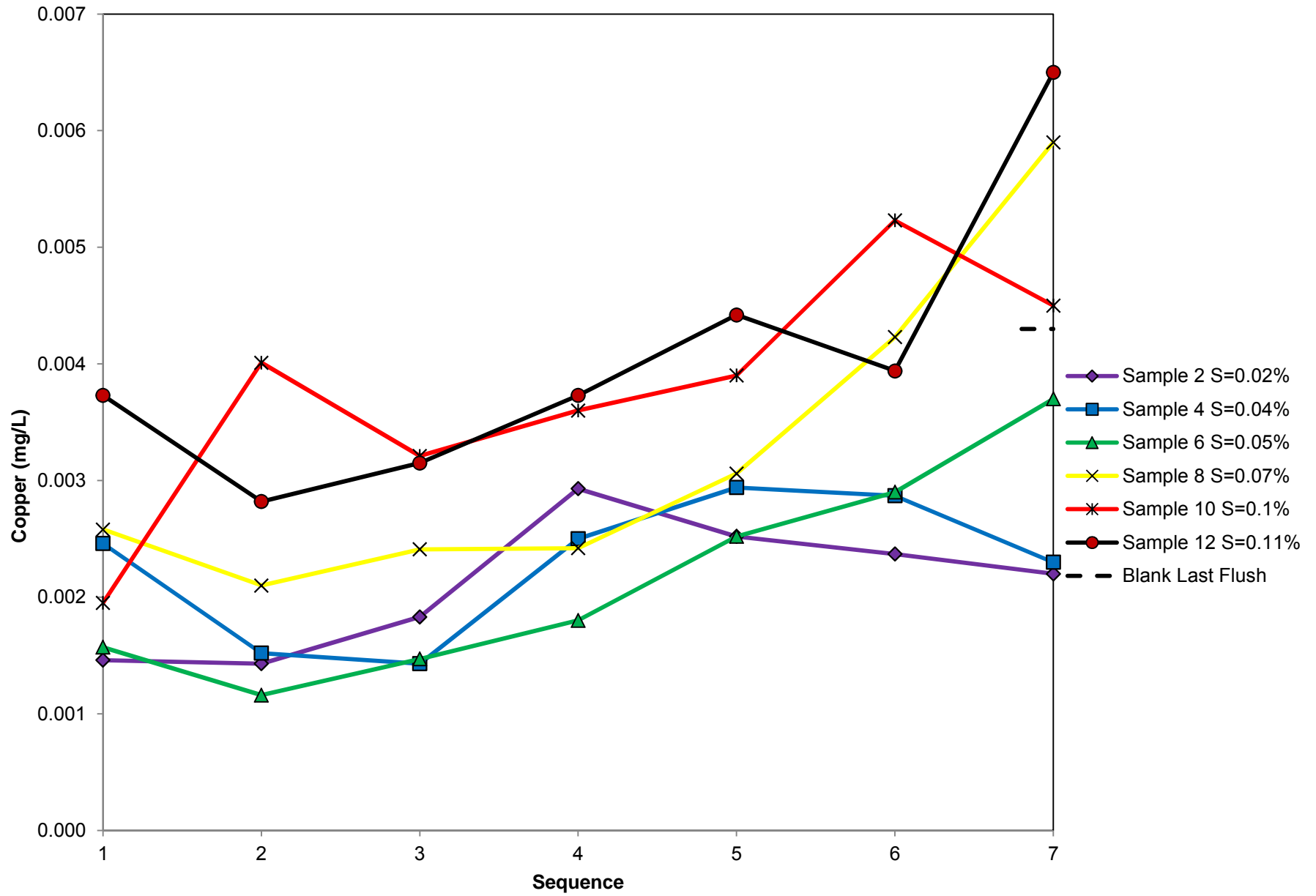

G:\PolyMet Mining\1UP005.01\_Northmet\_project\_2004\Testwork\2010-07\_SWMP\4.Interpretations\[SMWMP\_Graphs\_1UP005001\_SJD.ver00.xlsx]

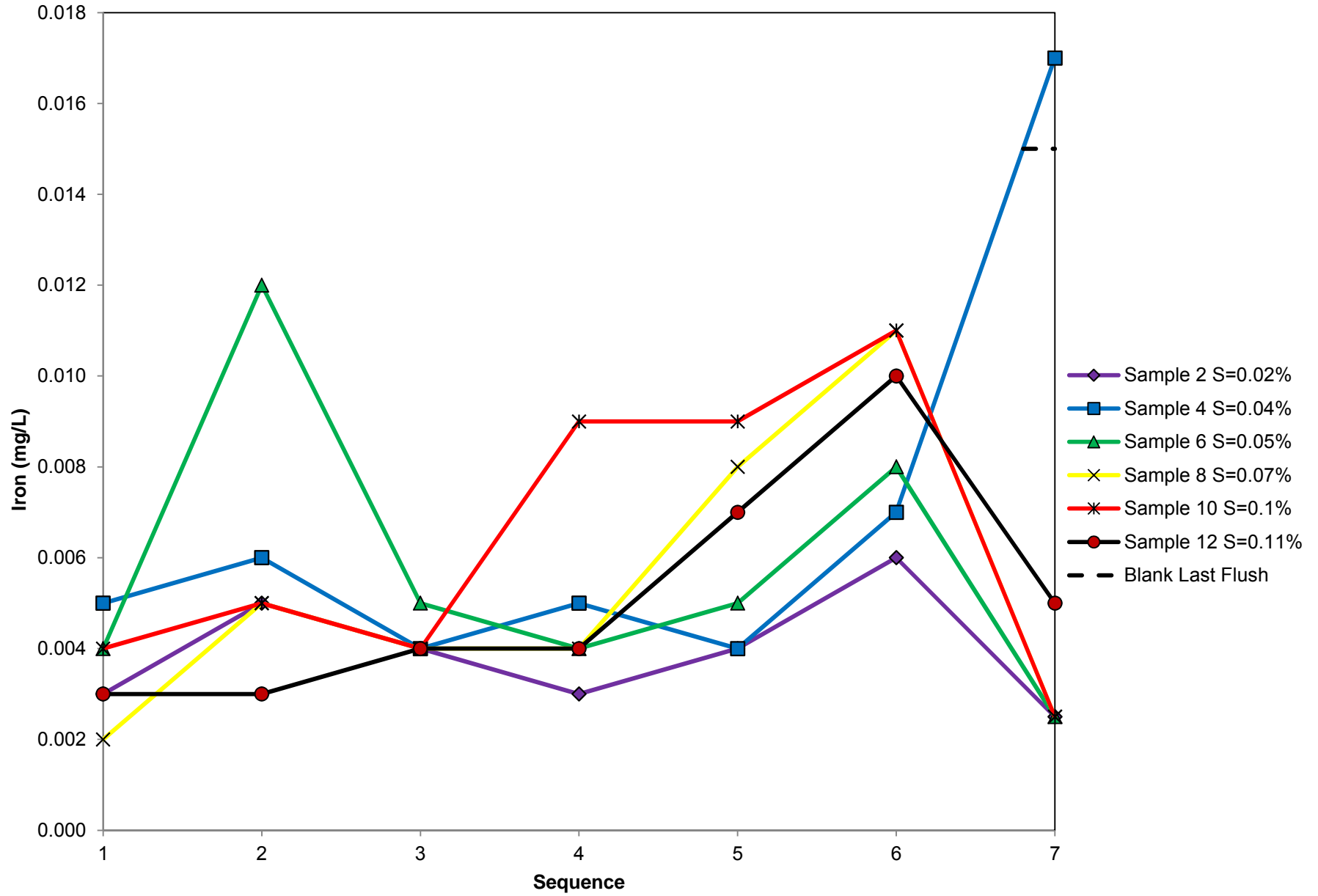

G:\PolyMet Mining\1UP005.01\_Northmet\_project\_2004\Testwork\2010-07\_SWMP\4.Interpretations\[SMWMP\_Graphs\_1UP005001\_SJD.ver00.xlsx]



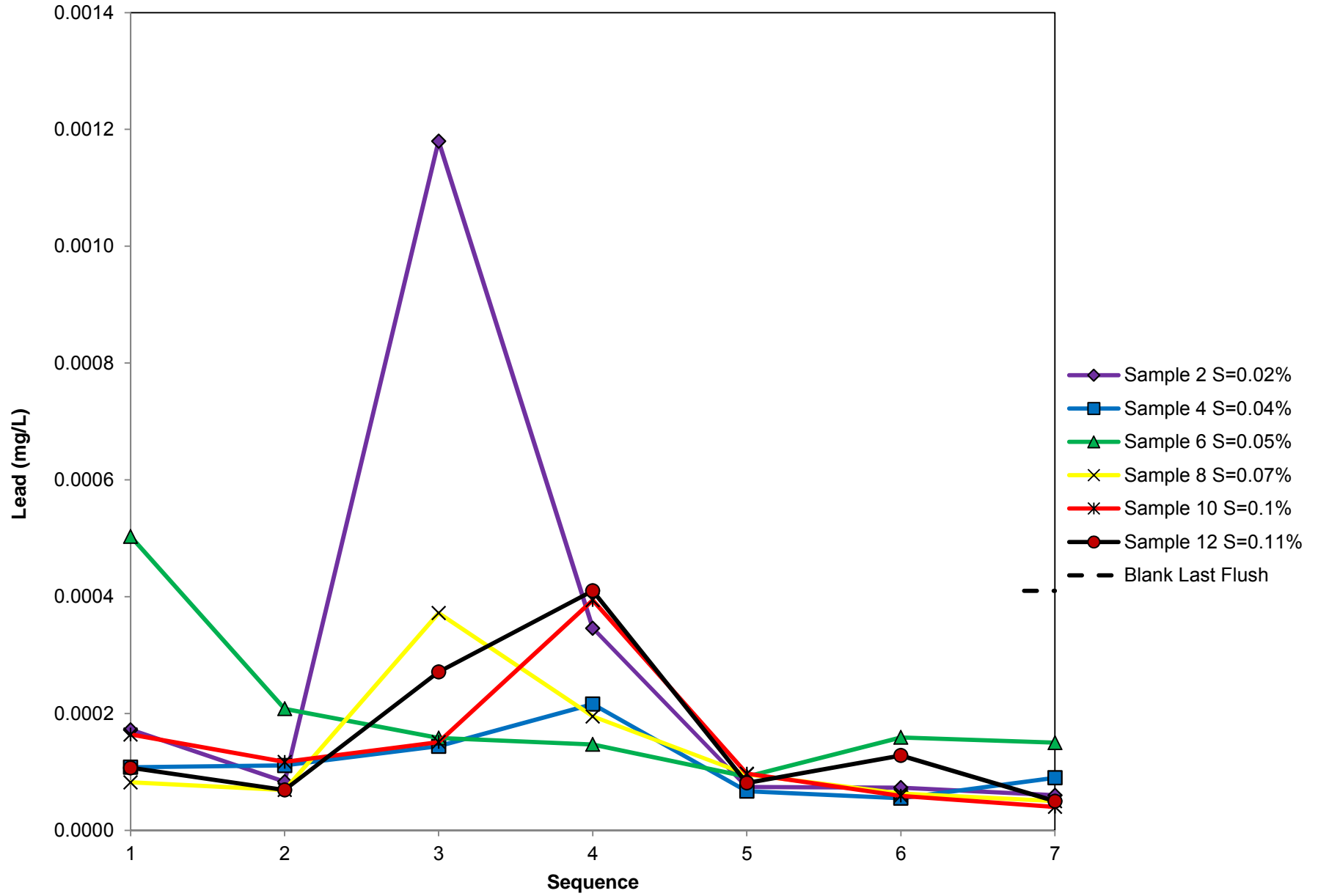

G:\PolyMet Mining\1UP005.01\_Northmet\_project\_2004\Testwork\2010-07\_SWMP\4.Interpretations\[SMWMP\_Graphs\_1UP005001\_SJD.ver00.xlsx]

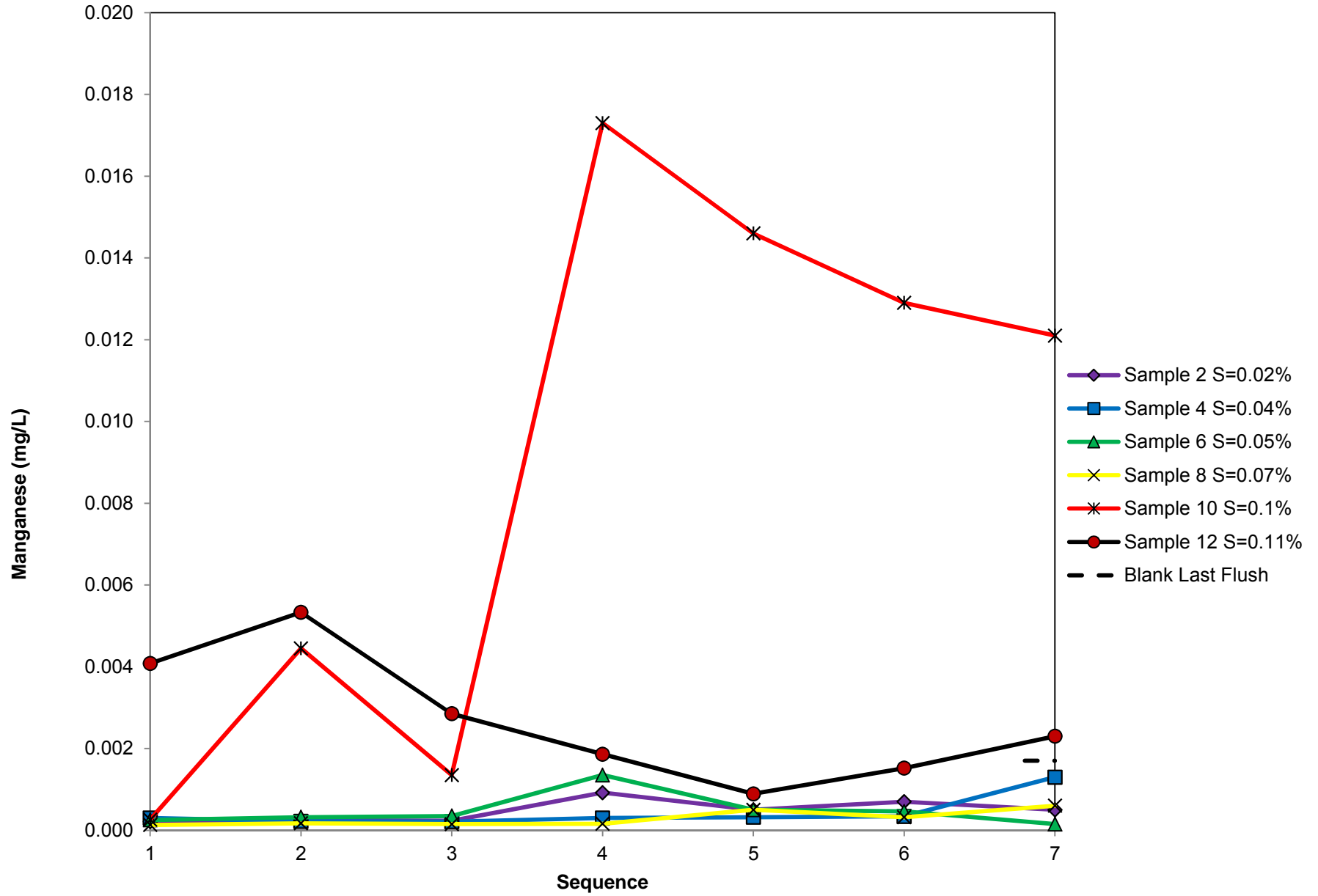

G:\PolyMet Mining\1UP005.01\_Northmet\_project\_2004\Testwork\2010-07\_SWMP\4.Interpretations\SMWMP\_Graphs\_1UP005001\_SJD.ver00.xlsx]

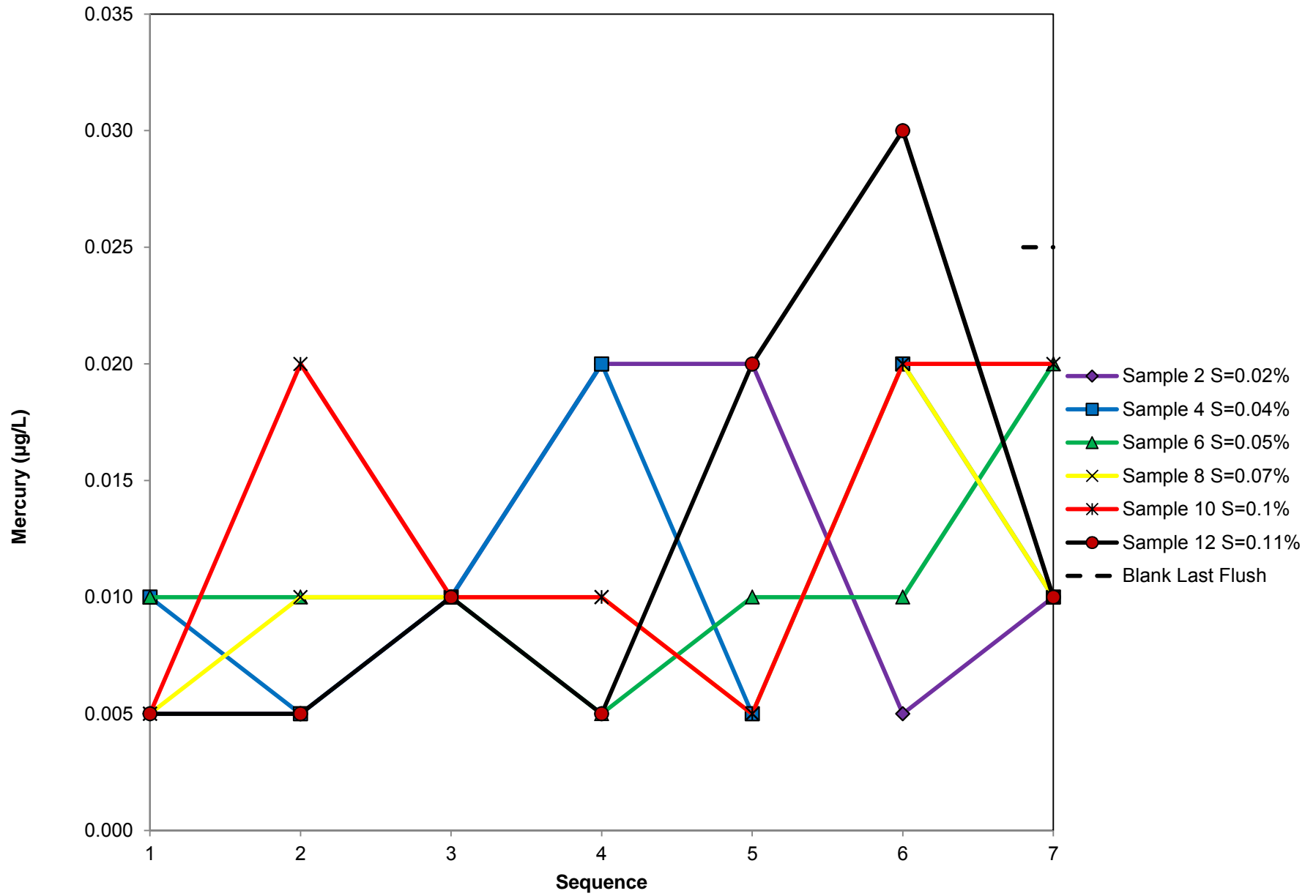

G:\PolyMet Mining\1UP005.01\_Northmet\_project\_2004\Testwork\2010-07\_SWMP\4.Interpretations\[SMWMP\_Graphs\_1UP005001\_SJD.ver00.xlsx]

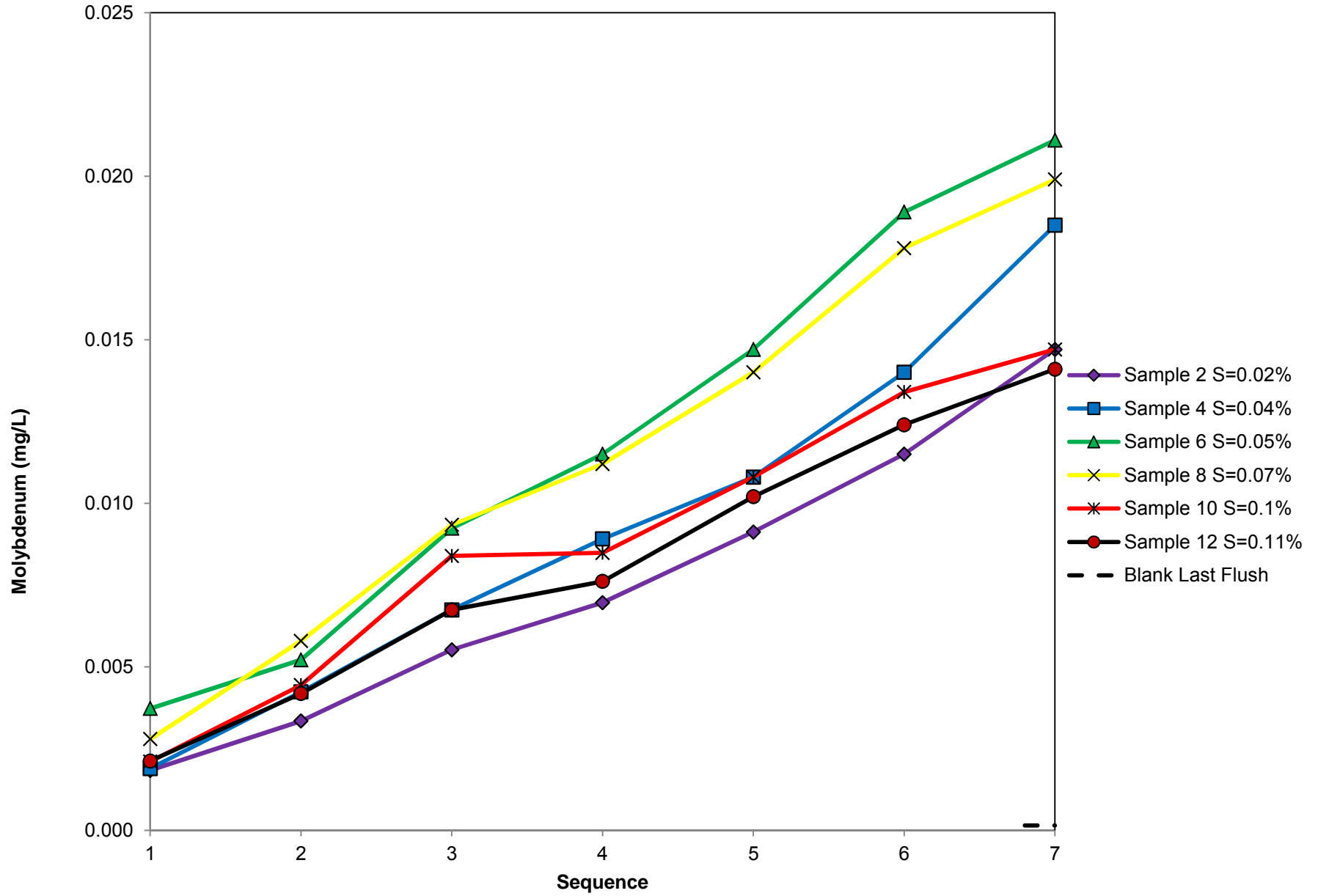

G:\PolyMet Mining\1UP005.01\_Northmet\_project\_2004\Testwork\2010-07\_SWMP\4.Interpretations\[SMWMP\_Graphs\_1UP005001\_SJD.ver00.xlsx]

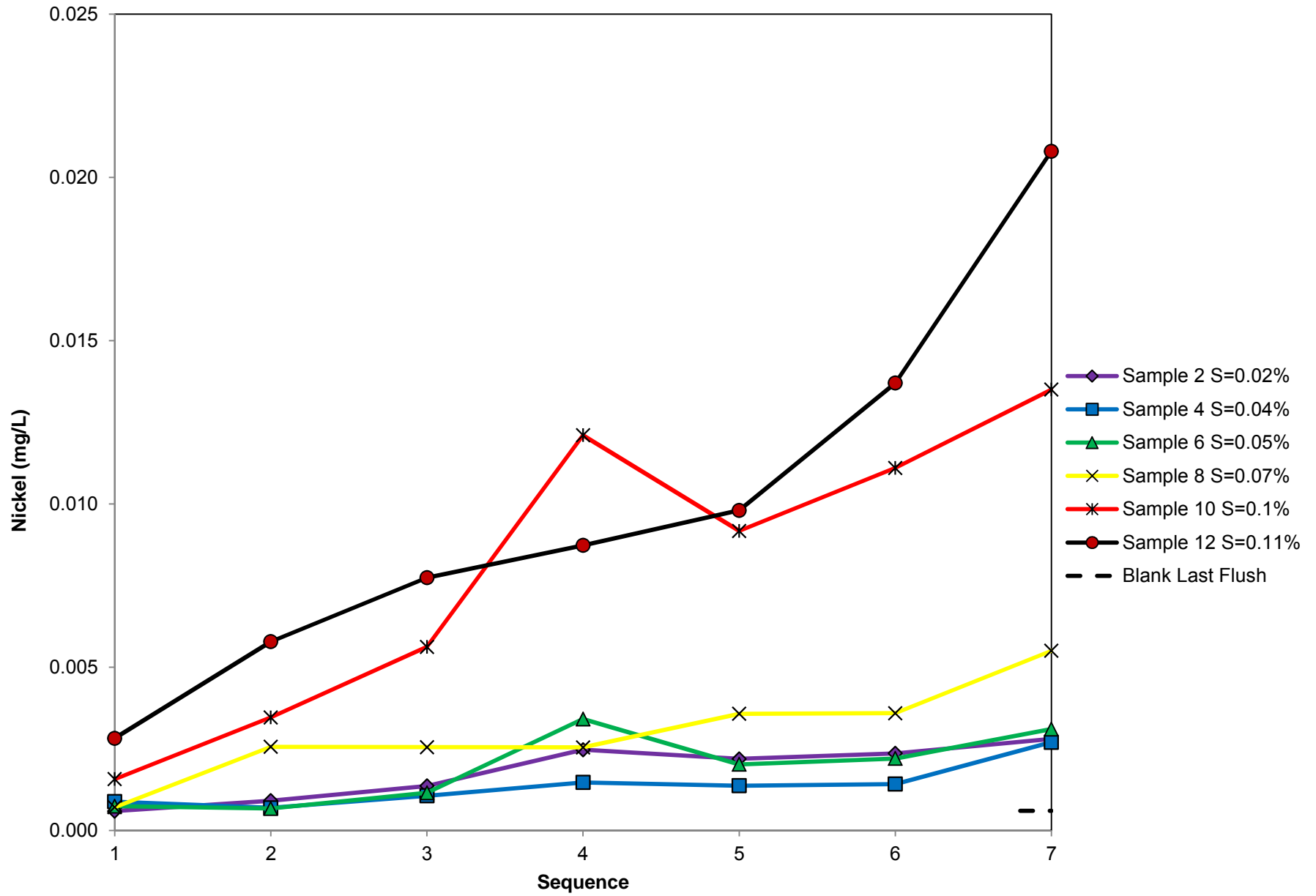

G:\PolyMet Mining\1UP005.01\_Northmet\_project\_2004\Testwork\2010-07\_SWMP\4.Interpretations\SMWMP\_Graphs\_1UP005001\_SJD.ver00.xlsx

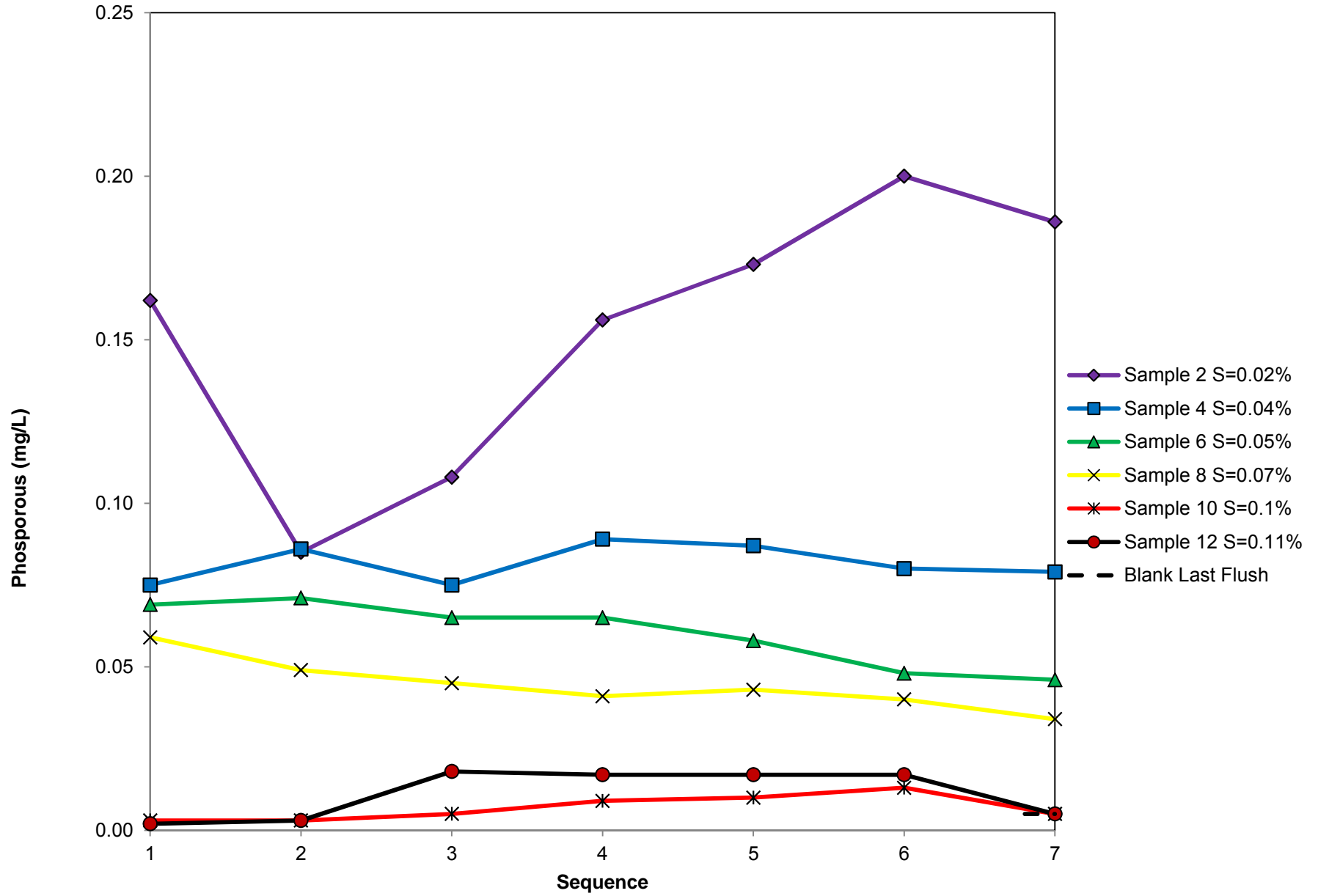

G:\PolyMet Mining\1UP005.01\_Northmet\_project\_2004\Testwork\2010-07\_SWMP\4.Interpretations\[SMWMP\_Graphs\_1UP005001\_SJD.ver00.xlsx]

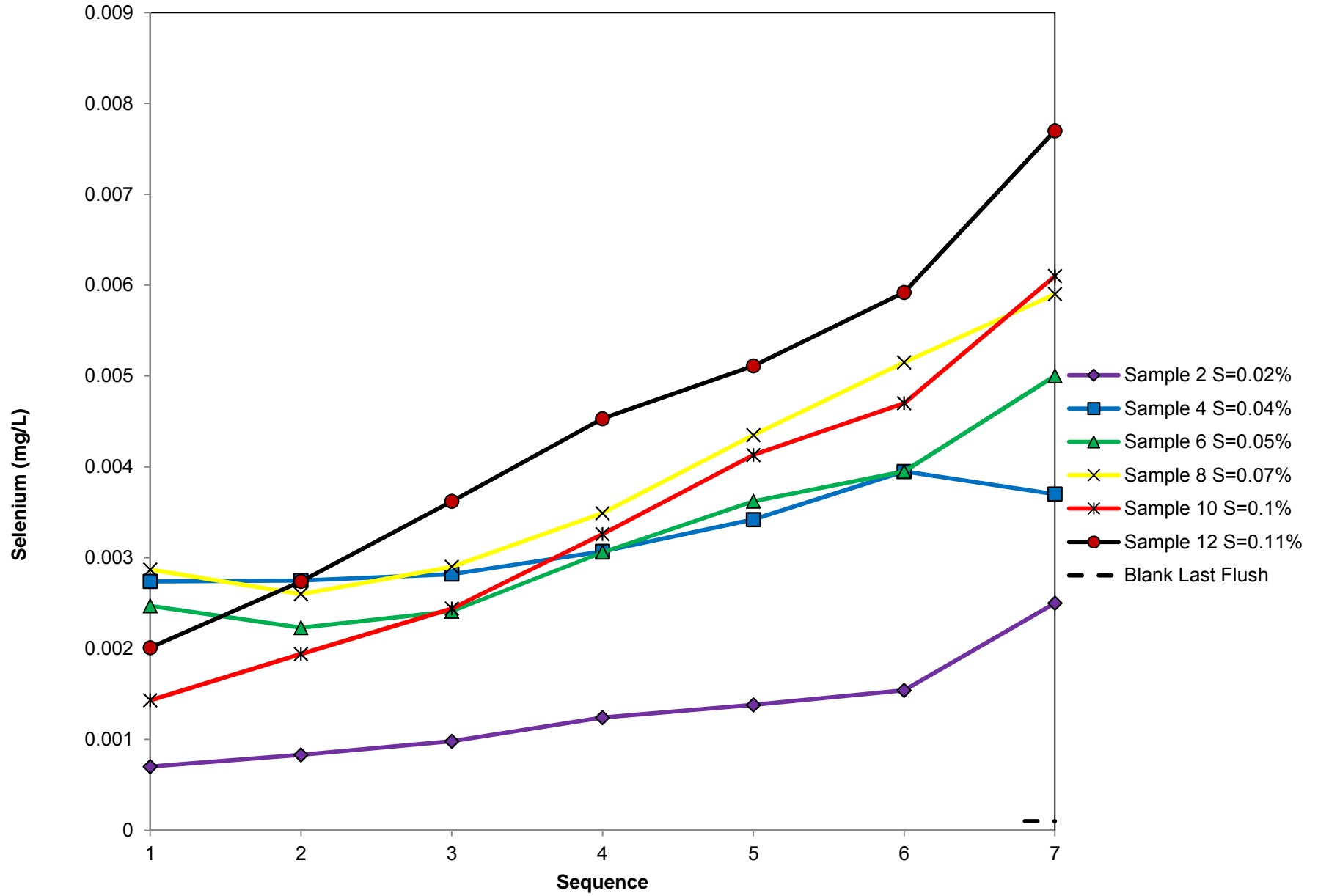

G:\PolyMet Mining\1UP005.01\_Northmet\_project\_2004\Testwork\2010-07\_SWMP\4.Interpretations\[SMWMP\_Graphs\_1UP005001\_SJD.ver00.xlsx]

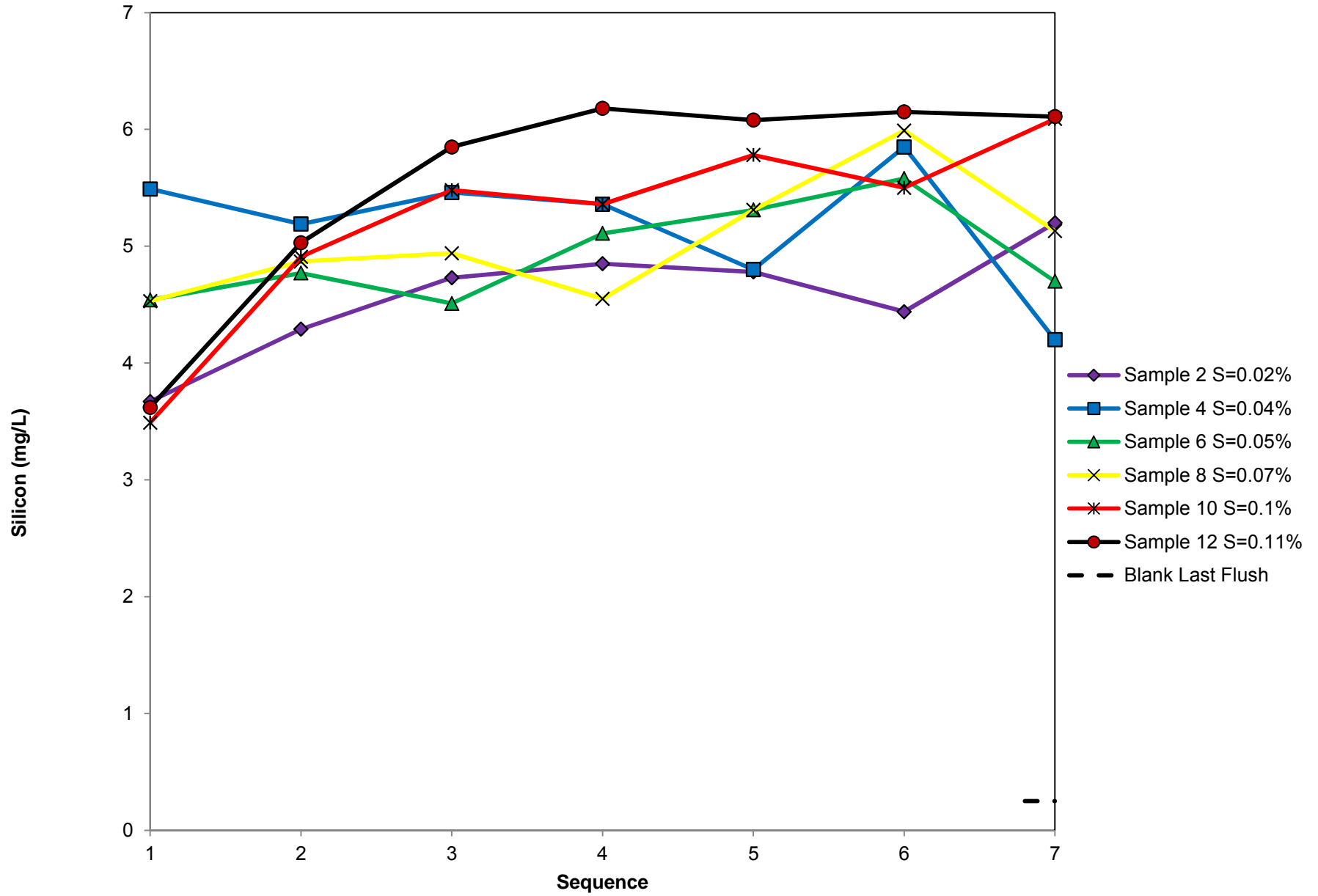

G:\PolyMet Mining\1UP005.01\_Northmet\_project\_2004\Testwork\2010-07\_SWMP\4.Interpretations\[SMWMP\_Graphs\_1UP005001\_SJD.ver00.xlsx]



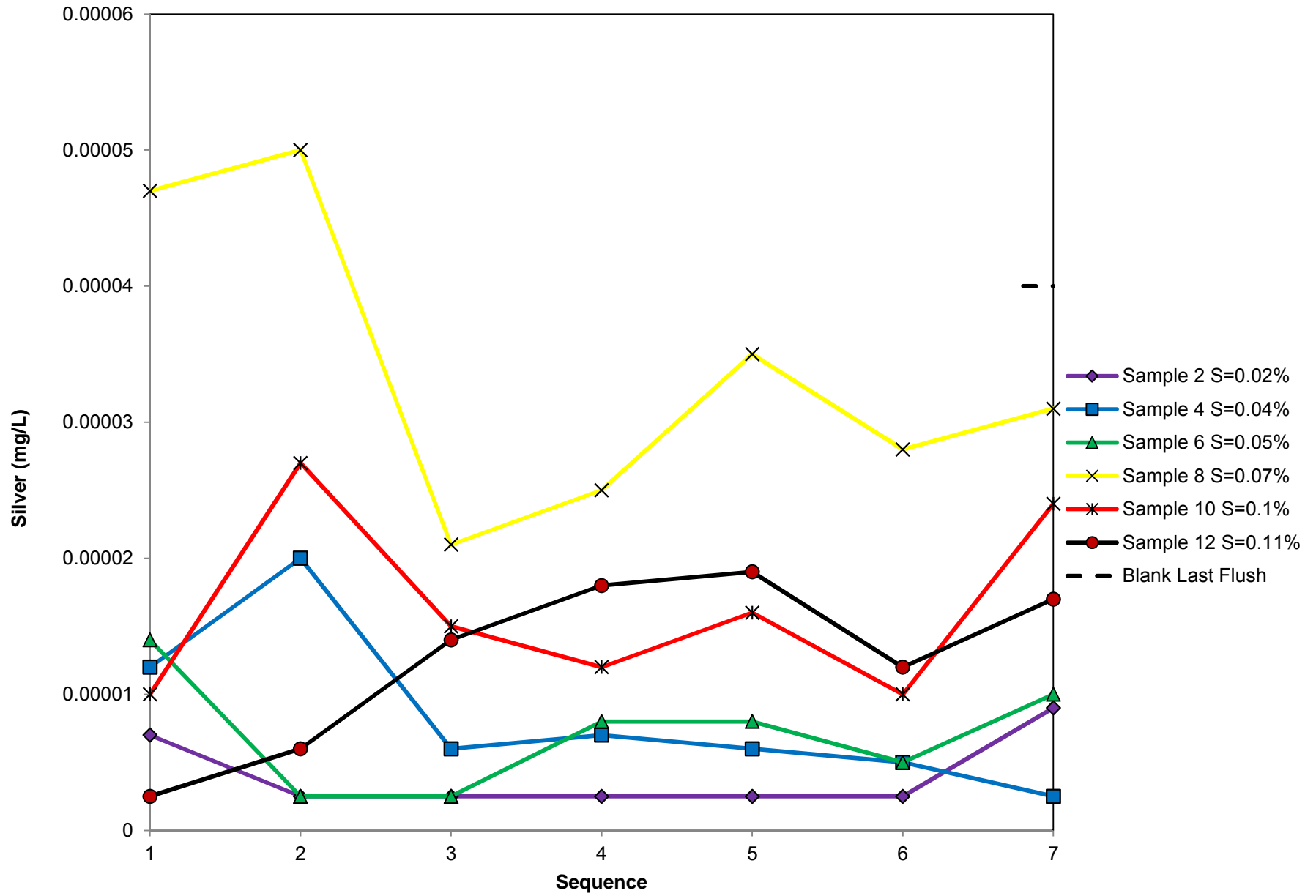

G:\PolyMet Mining\1UP005.01\_Northmet\_project\_2004\Testwork\2010-07\_SWMP\4.Interpretations\[SMWMP\_Graphs\_1UP005001\_SJD.ver00.xlsx]

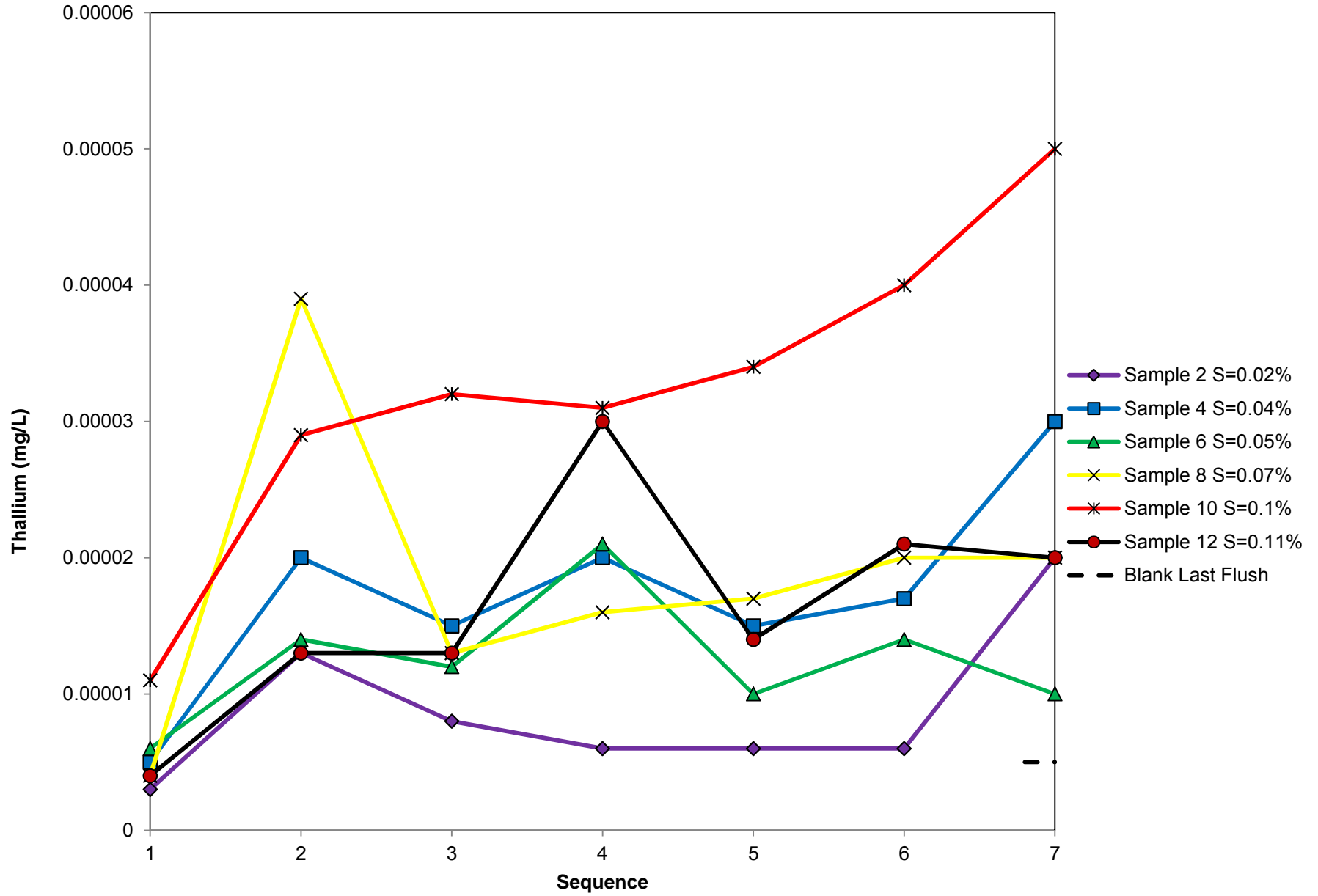

G:\PolyMet Mining\1UP005.01\_Northmet\_project\_2004\Testwork\2010-07\_SWMP\4.Interpretations\[SMWMP\_Graphs\_1UP005001\_SJD.ver00.xlsx]

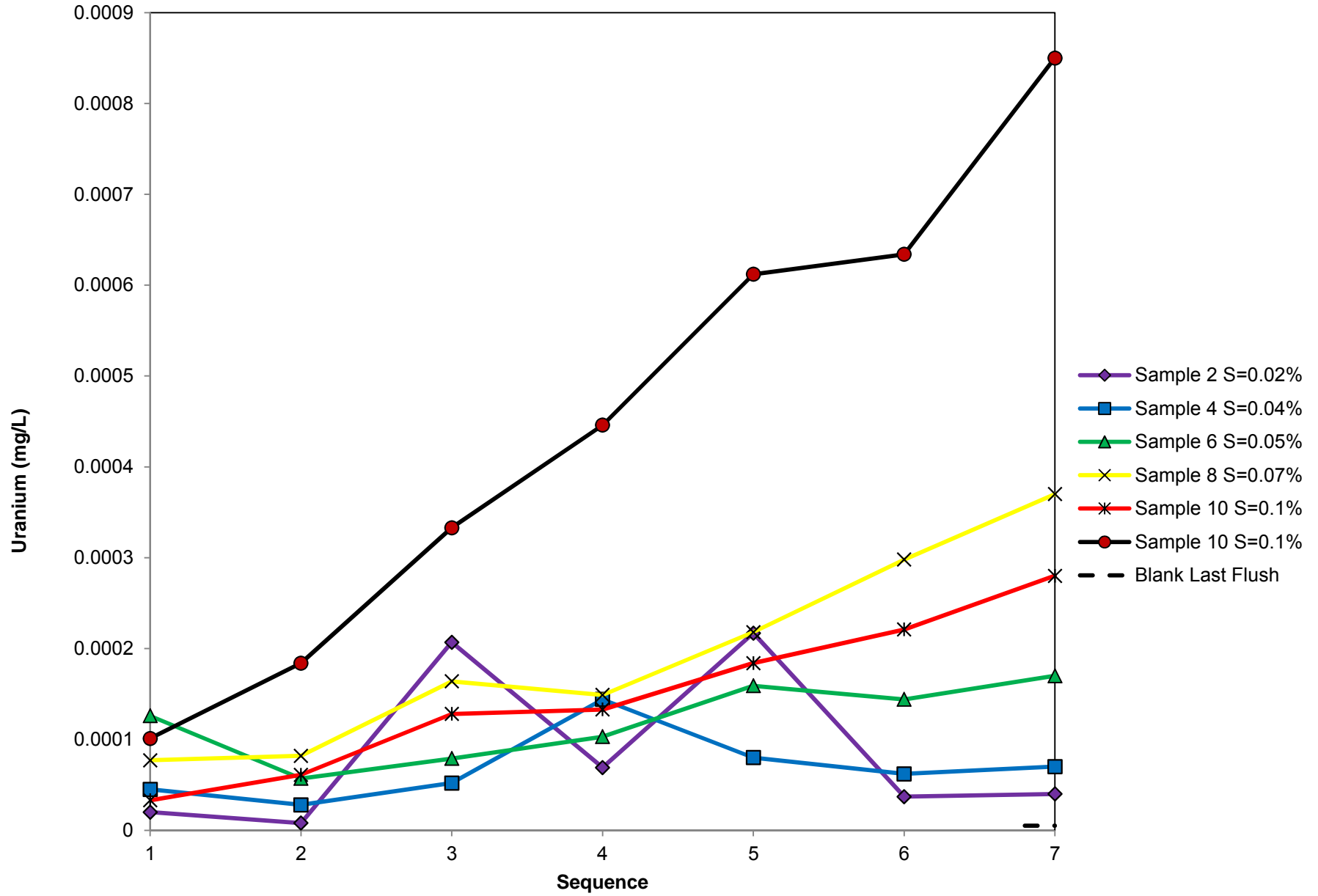

G:\PolyMet Mining\1UP005.01\_Northmet\_project\_2004\Testwork\2010-07\_SWMP\4.Interpretations\SMWMP\_Graphs\_1UP005001\_SJD.ver00.xlsx

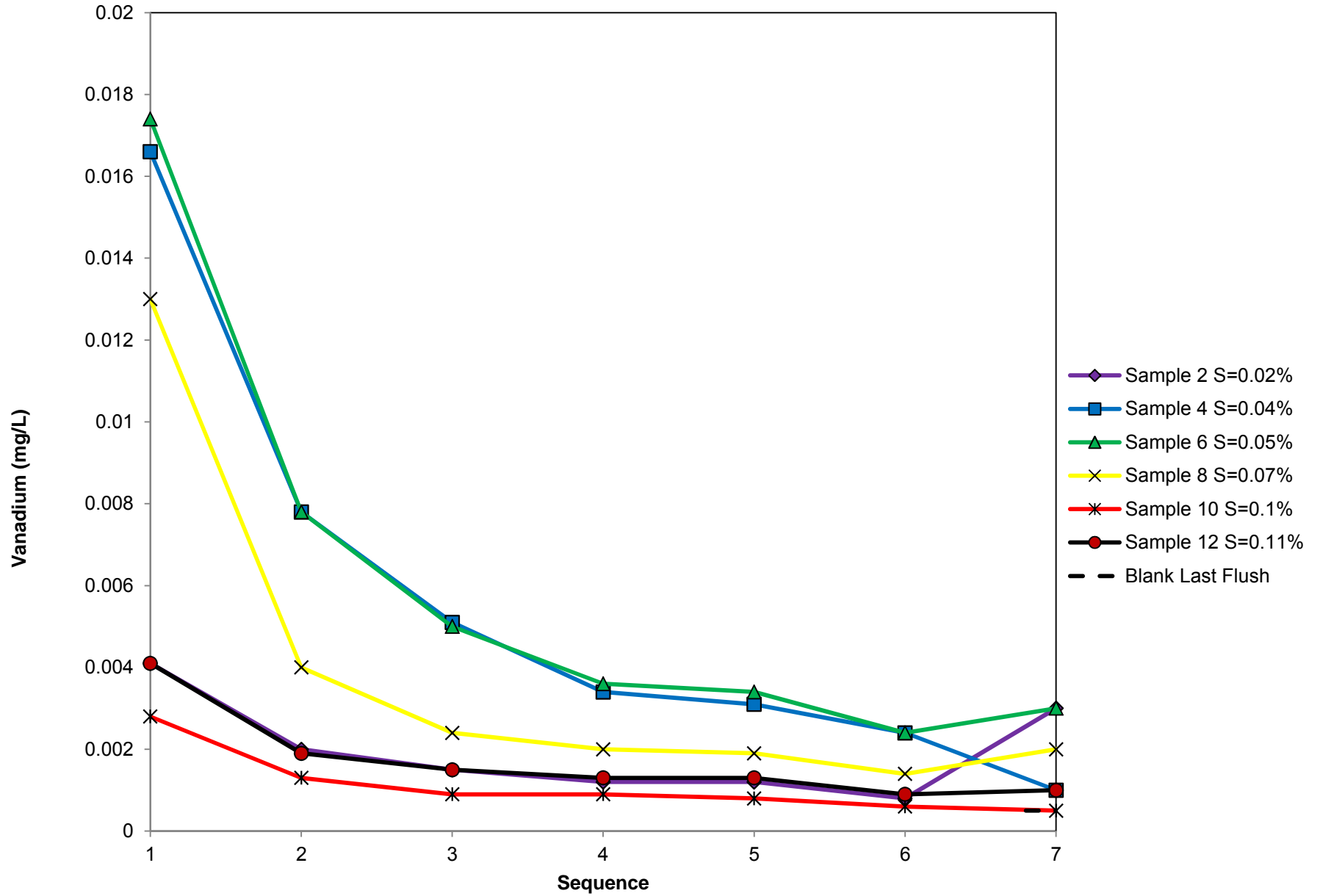

G:\PolyMet Mining\1UP005.01\_Northmet\_project\_2004\Testwork\2010-07\_SWMP\4.Interpretations\[SMWMP\_Graphs\_1UP005001\_SJD.ver00.xlsx]

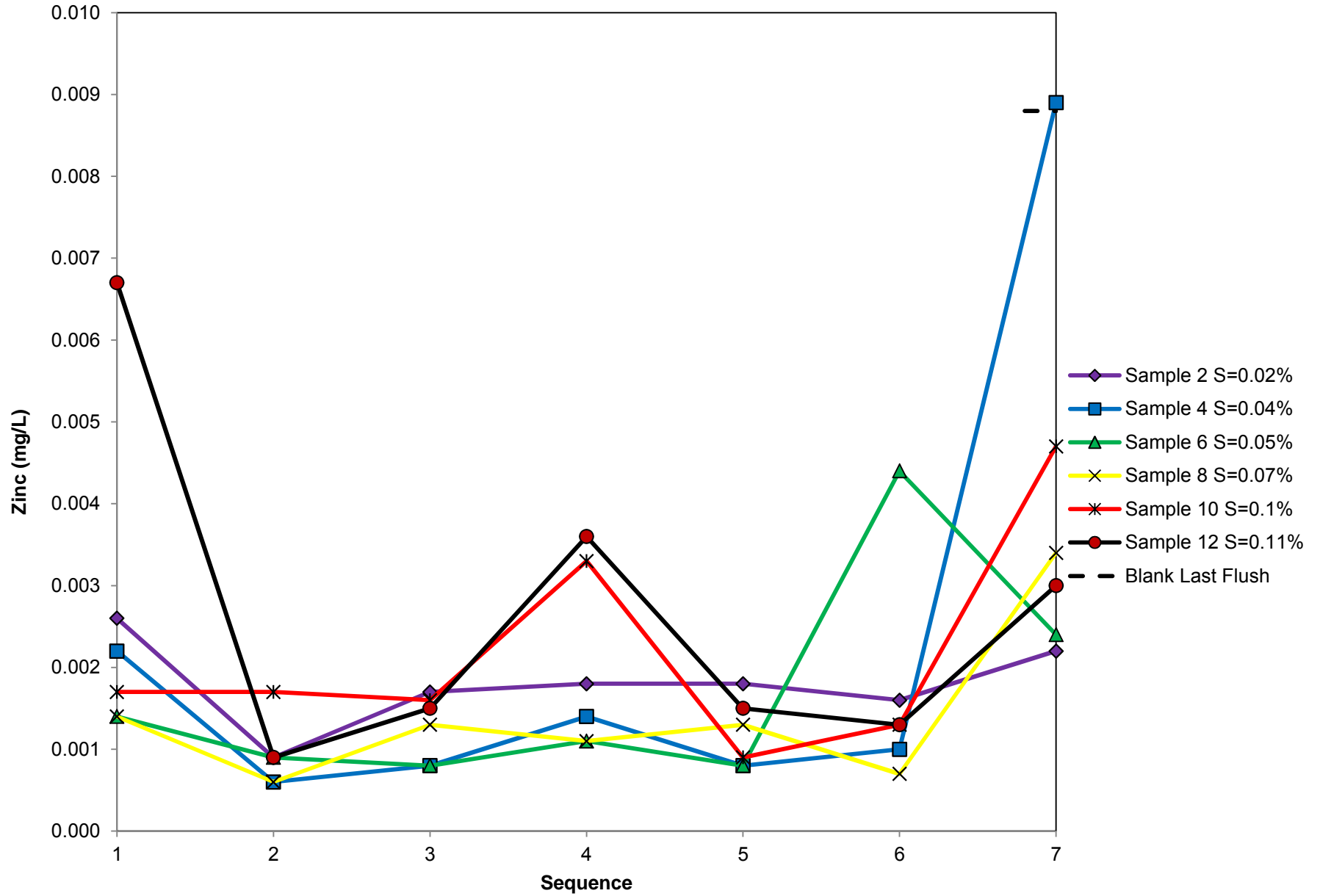

G:\PolyMet Mining\1UP005.01\_Northmet\_project\_2004\Testwork\2010-07\_SWMP\4.Interpretations\SMWMP\_Graphs\_1UP005001\_SJD.ver00.xlsx

Attachment 3  
Graphs of Saturation Indices

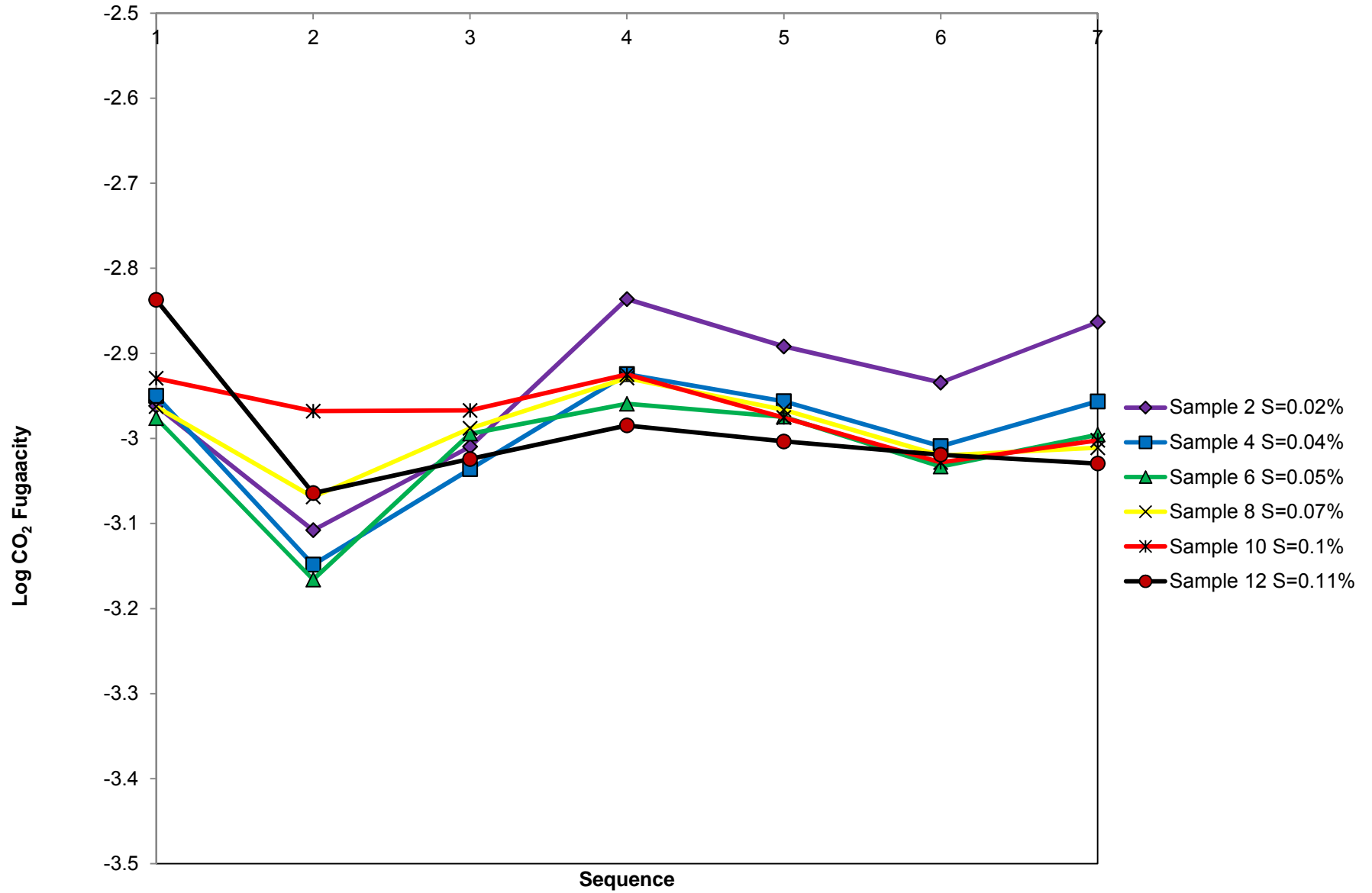

G:\PolyMet Mining\1UP005.01\_Northmet\_project\_2004\Testwork\2010-07\_SWMP\4.Interpretations\SMWMP\_Graphs\_1UP005001\_SJD.ver00.xlsx

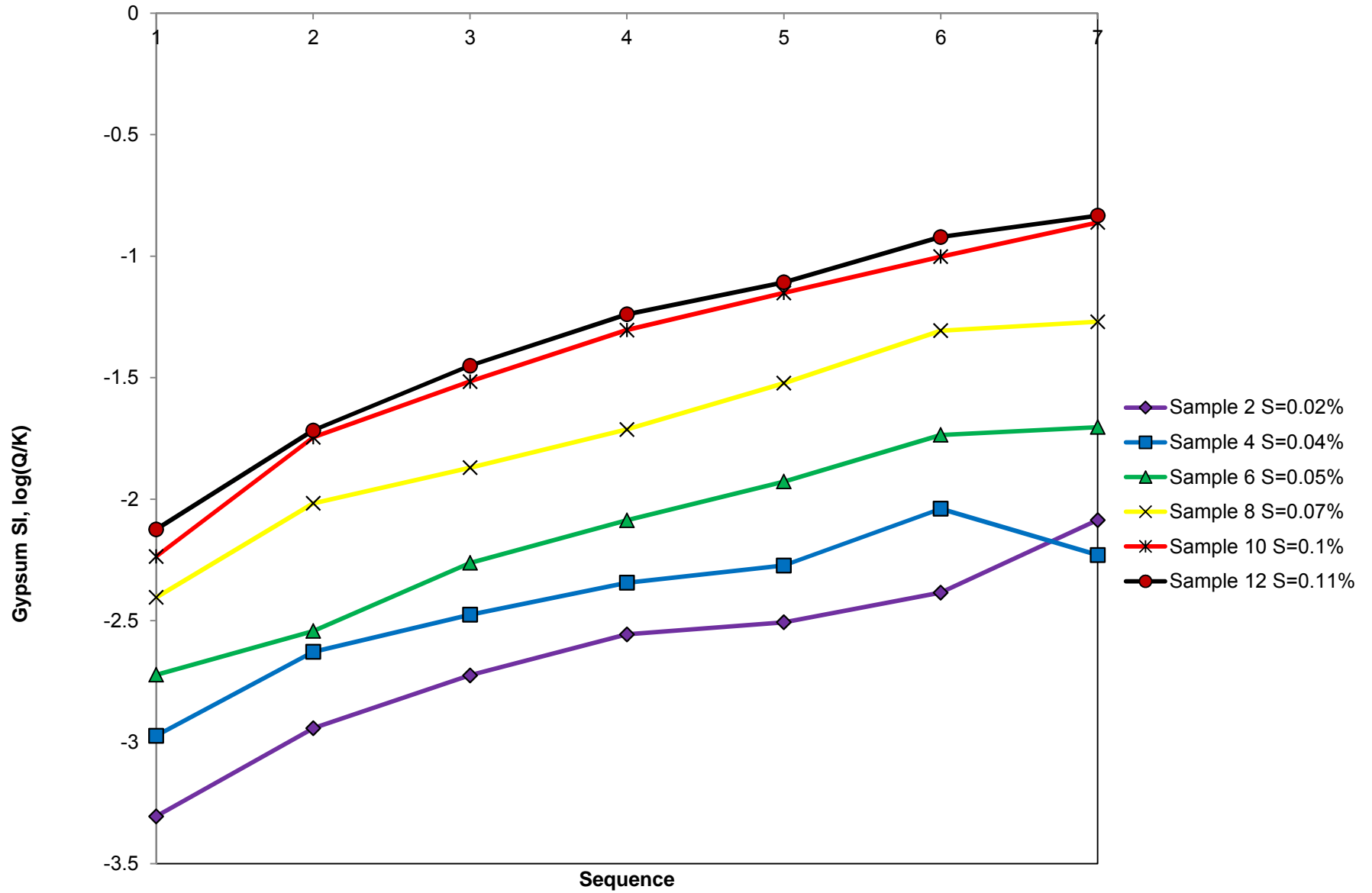

G:\PolyMet Mining\1UP005.01\_Northmet\_project\_2004\Testwork\2010-07\_SWMP\4.Interpretations\SMWMP\_Graphs\_1UP005001\_SJD.ver00.xlsx



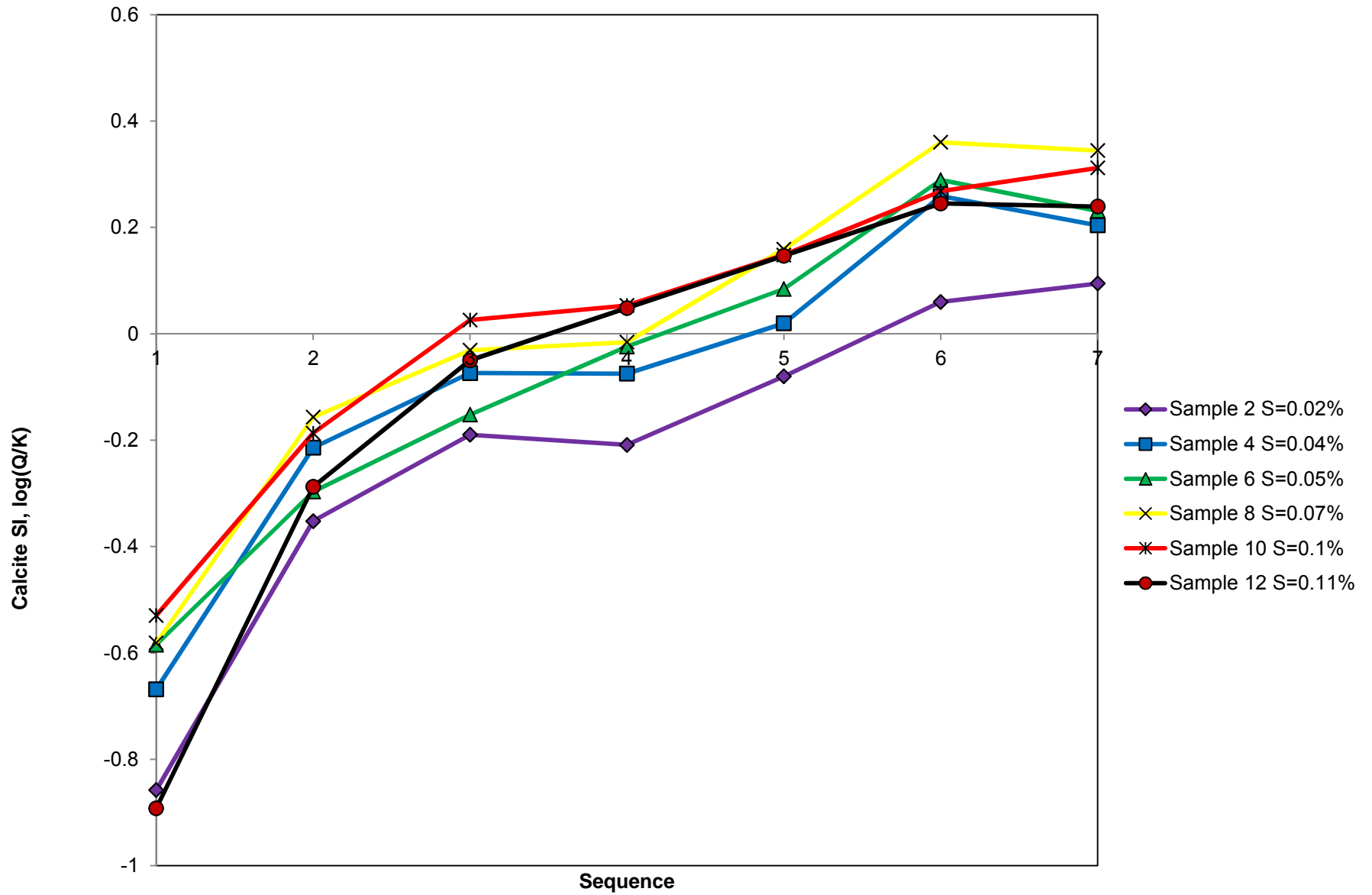

G:\PolyMet Mining\1UP005.01\_Northmet\_project\_2004\Testwork\2010-07\_SWMP\4.Interpretations\[SMWMP\_Graphs\_1UP005001\_SJD.ver00.xlsx]

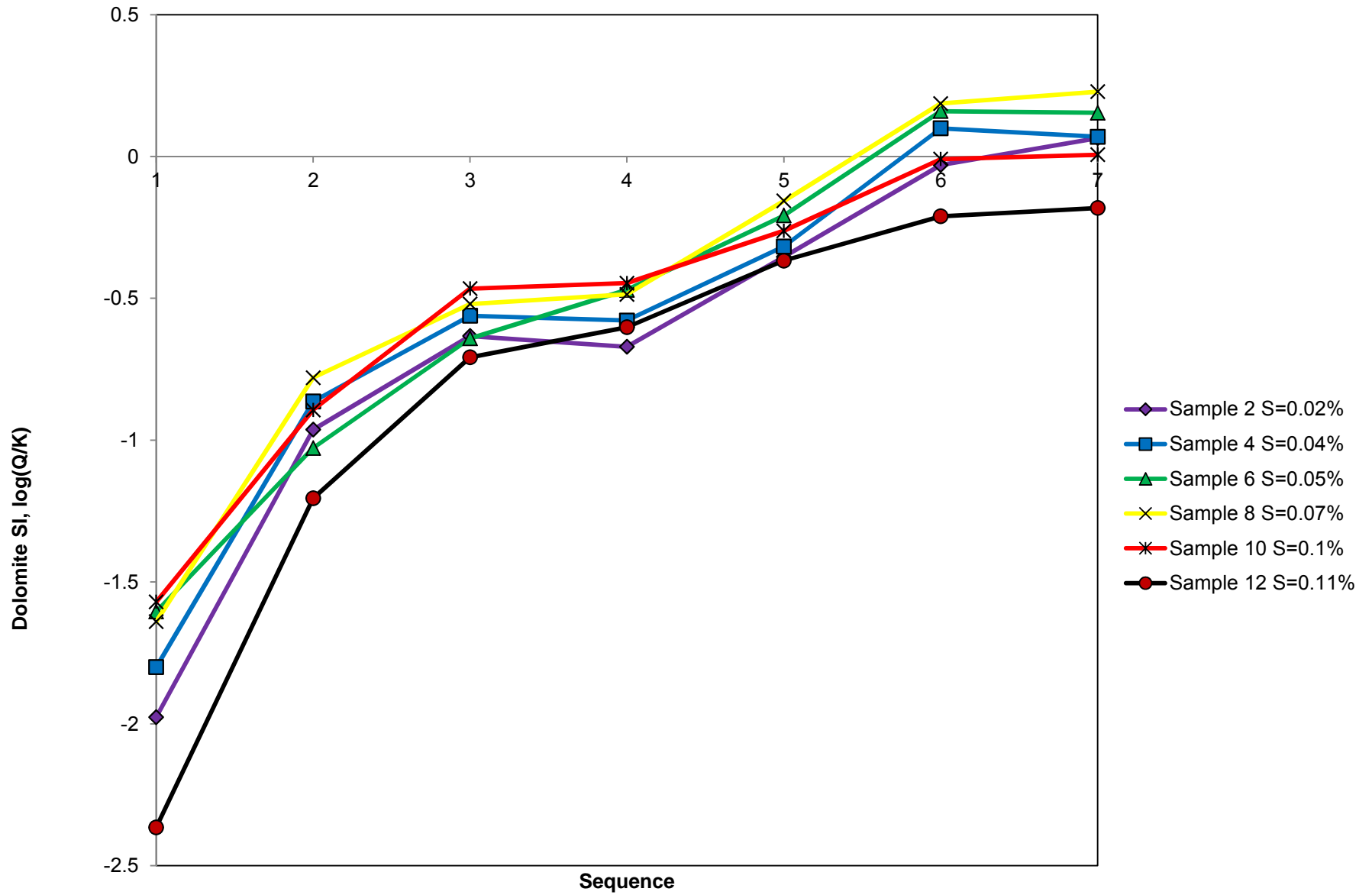

G:\PolyMet Mining\1UP005.01\_Northmet\_project\_2004\Testwork\2010-07\_SWMP\4.Interpretations\SMWMP\_Graphs\_1UP005001\_SJD.ver00.xlsx

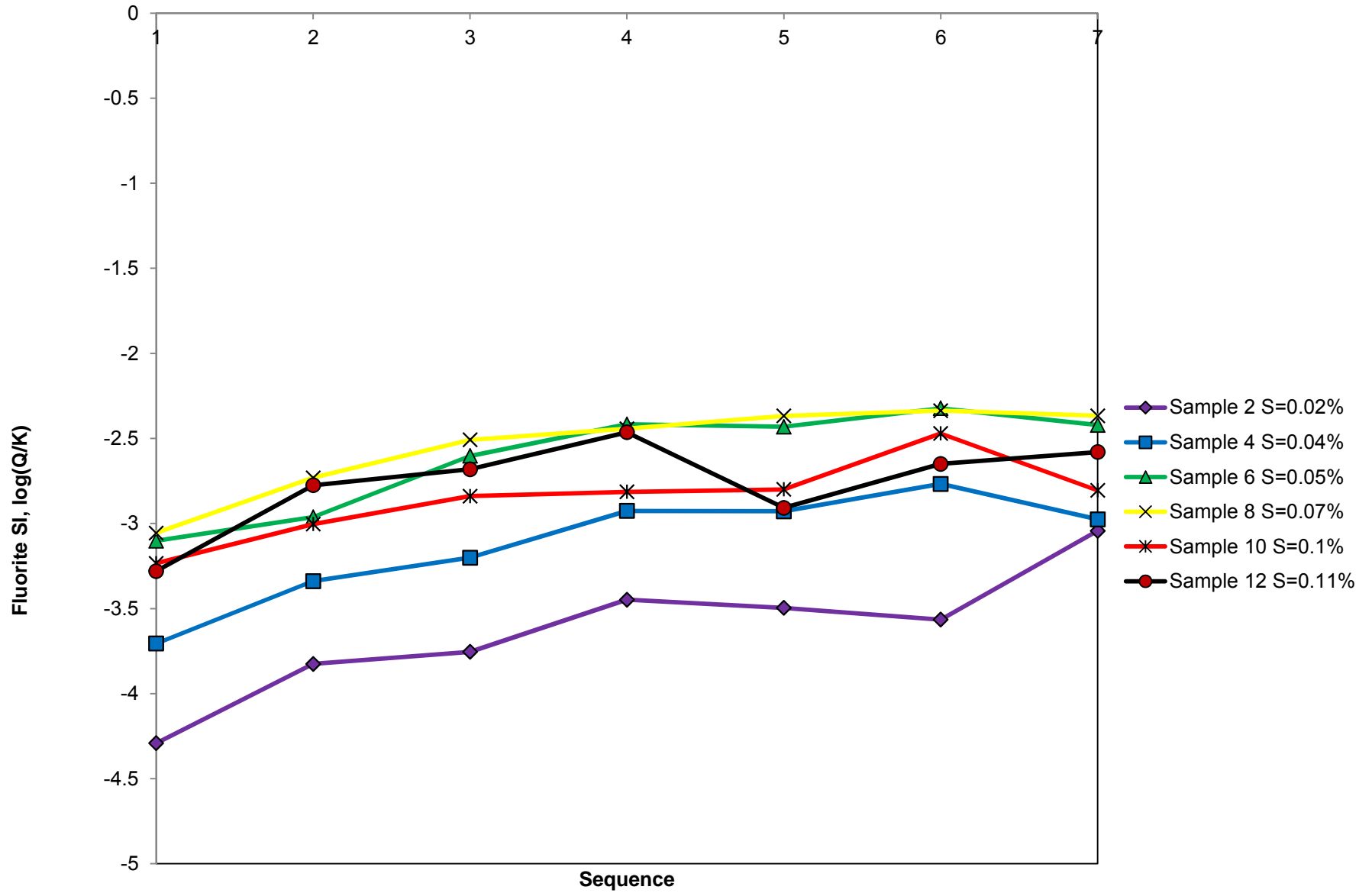

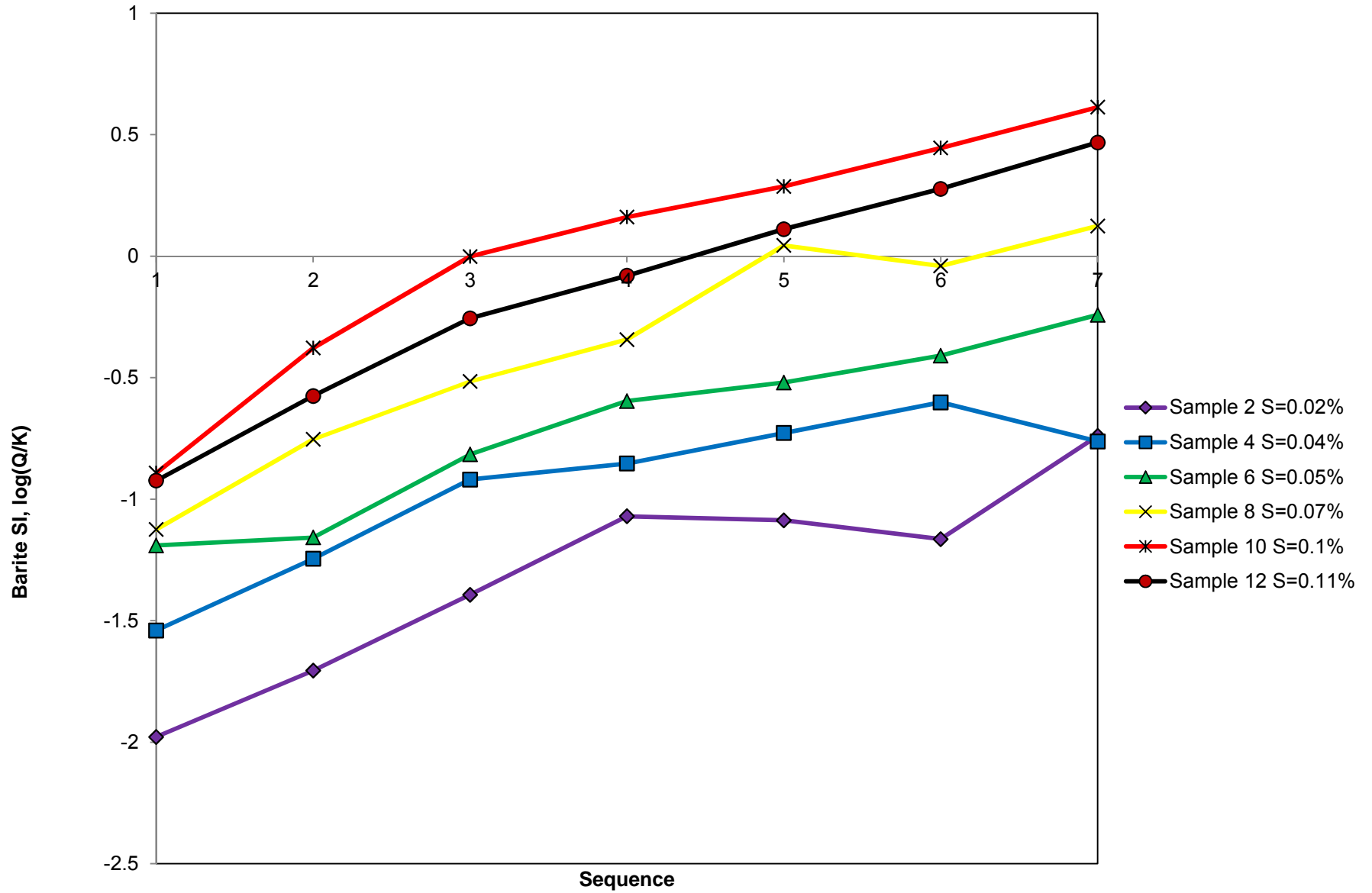

G:\PolyMet Mining\1UP005.01\_Northmet\_project\_2004\Testwork\2010-07\_SWMP\4.Interpretations\SMWMP\_Graphs\_1UP005001\_SJD.ver00.xlsx

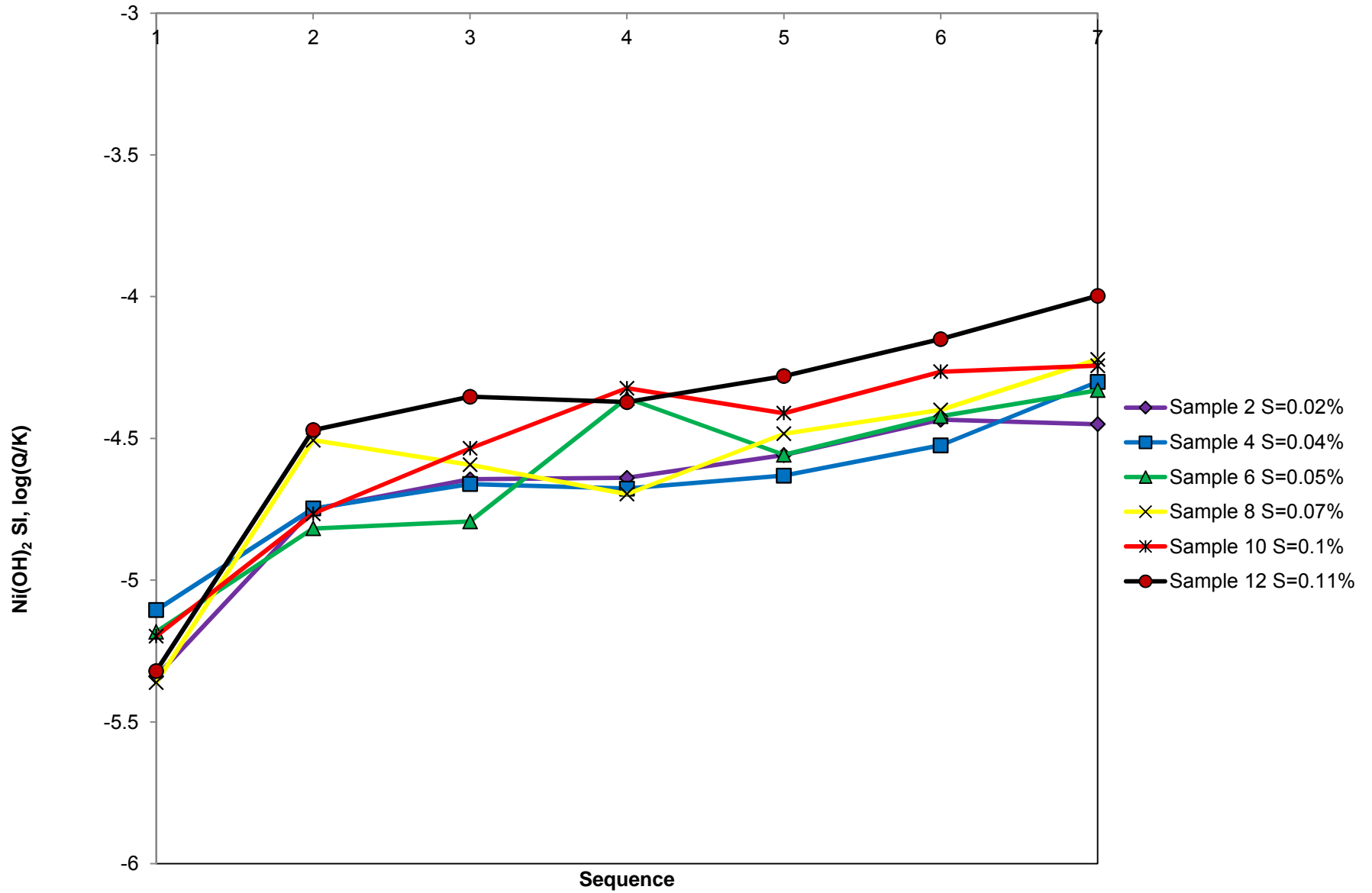

G:\PolyMet Mining\1UP005.01\_Northmet\_project\_2004\Testwork\2010-07\_SWMP\4.Interpretations\SMWMP\_Graphs\_1UP005001\_SJD.ver00.xlsx

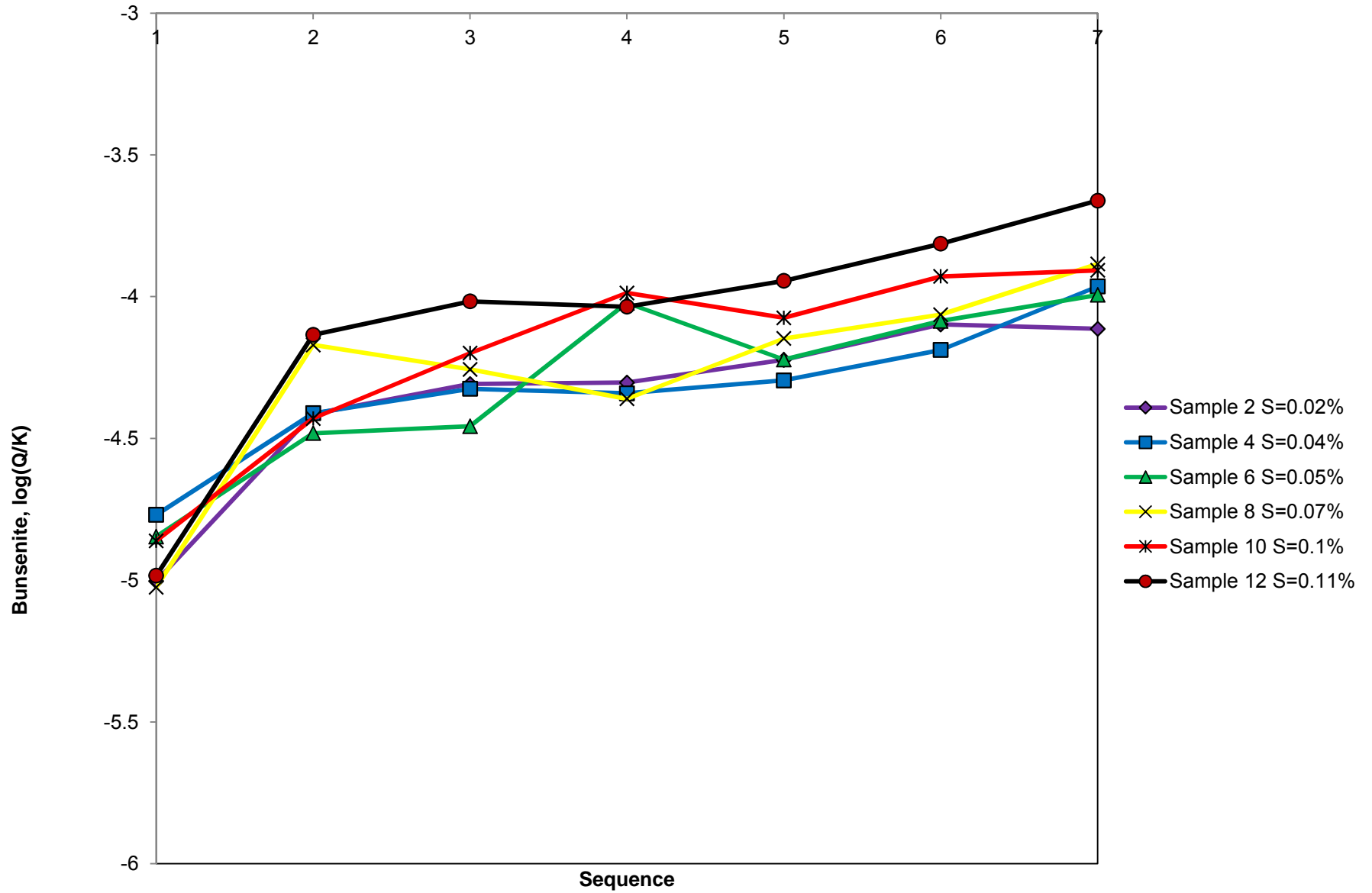

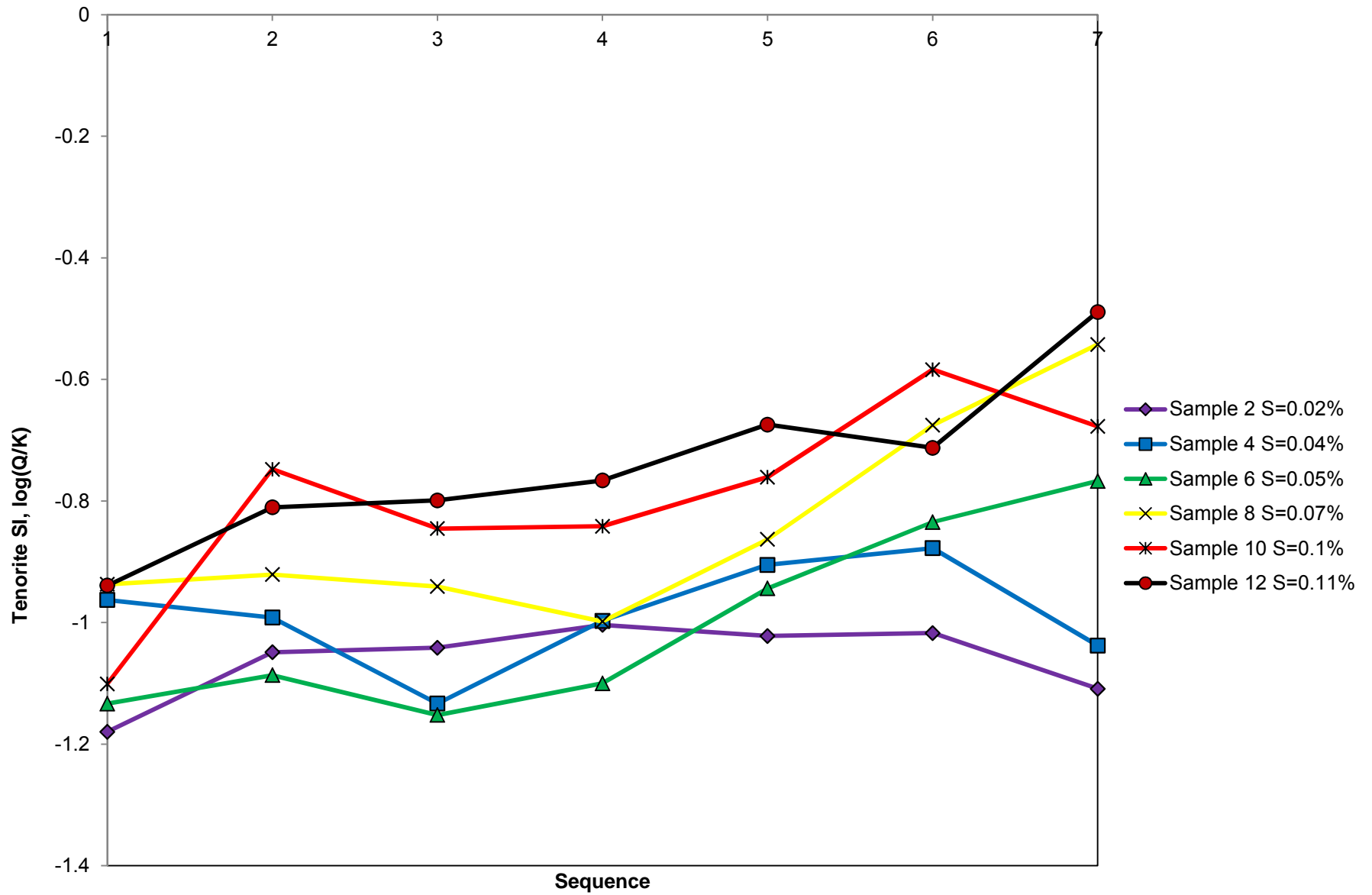

G:\PolyMet Mining\1UP005.01\_Northmet\_project\_2004\Testwork\2010-07\_SWMP\4.Interpretations\SMWMP\_Graphs\_1UP005001\_SJD.ver00.xlsx

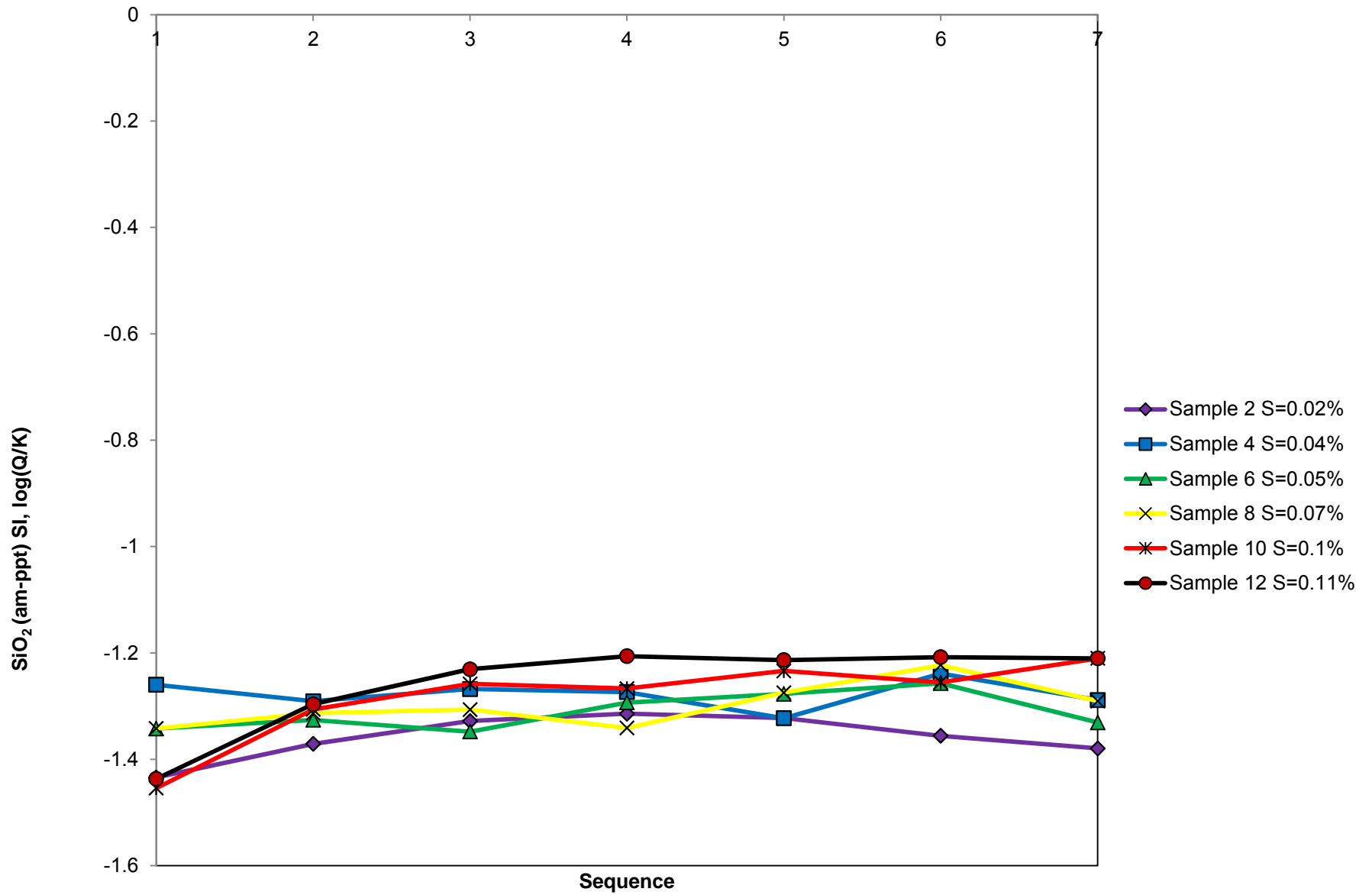

G:\PolyMet Mining\1UP005.01\_Northmet\_project\_2004\Testwork\2010-07\_SWMP\4.Interpretations\SMWMP\_Graphs\_1UP005001\_SJD.ver00.xlsx



**Attachment C**

**2015 Update on Kinetic Test Data**

## Memo

---

<b>To:</b>	Jim Scott	<b>Date:</b>	January 21, 2015 <sup>1</sup>
<b>Company:</b>	PolyMet Mining	<b>From:</b>	Stephen Day
<b>Copy to:</b>		<b>Project #:</b>	1UP005.001
<b>Subject:</b>	Update on Kinetic Test Data, NorthMet Project – DRAFT		

---

### 1 Introduction

Kinetic tests (mainly humidity cells) were initiated for the NorthMet Project in 2004 on samples of rock, simulated tailings and hydrometallurgical process residues according to overall program designs prepared following discussion between PolyMet Mining Inc. (PolyMet), Minnesota Department of Natural Resources (MDNR) and SRK Consulting (Canada) Inc. (SRK). Results from these tests have been used at various junctures of the project to develop waste management plans and evaluate project environmental effects. In 2009, the program was modified in consultation with MDNR to stop some tests and modify the frequency of analysis of leachates based on trend interpretation (SRK 2009).

The purpose of this memorandum is to provide an update on the progress of the testwork and transmit release rates as it relates to water quality source term predictions in the Environmental Impact Statement (EIS).

### 2 Data Presentation

Electronic updates to the data graphing and calculations are available on Barr Engineering's NorthMet Project website. The data period covered by the testwork now includes up to 6.5 years because some waste rock humidity cells were initiated in August 2005. The cutoff for interpreting data for this update was the end of January to early February 2012. Due to reduced analytical frequency for most tests (SRK 2009), complete QA review and update of the database occurs quarterly. Data collected subsequent to February 2012 completed QA after this update was prepared and are not included in this review.

### 3 Waste Rock, Lean Ore and Ore Kinetic Tests

#### 3.1 Status of Program

The original waste rock humidity cell program consisted of 92 tests distributed according to the four initially defined classifications shown in Table 1. Waste rock was subsequently classified into three categories. The current program consists of 43 tests with most ongoing tasks in the mid-sulfur range for waste rock and lean ore (19 tests). Table 2 shows all samples and the testwork duration used to calculate rates for use in water quality predictions.

The primary uses of the data in the waste characterization program are to:

- Understand long term performance of wastes and inform definition of waste management categories based on sulfur content; and
- Provide leaching rates for use in source term geochemical predictions.

---

<sup>1</sup> This version replaces a memo of the same title dated October 19, 2012 to correct graphs shown in Figure 1.

**Table 1. Sample Categories**

Initial Classification	Waste Category	Totals	Stopped	Continuing
S≤0.05%	1	27	20	7
S>0.05%	1	10	6	4
	2/3	14	3	11
	4	13	8	5
Lean Ore	1	4	3	1
	2/3	13	5	8
	4	8	4	4
Ore	Not applicable	3	0	3
Totals	All	92	49	43

Source: G:\PolyMet  
Mining\1UP005.01\_Northmet\_project\_2004\Testwork\WR\_KT\Characteristics\Humidity\_Cell\_Table\1UP005.001\_WR\_Outcomes\_ver01.xlsx\Testwork Tallies

Results are described below in the context of these two objectives. Each heading describes results according to the waste categories (1, 2/3 and 4). Charts for indicator parameters are shown to indicate major features (Figures 1 to 4). Overall tendency toward acidic conditions is shown by pH. Sulfate indicates sulfide mineral oxidation rates. Nickel is shown because as observed in this test program and testwork performed previously by DNR it (along with cobalt) tends to respond first to declining pH. Copper is shown because it leaches more rapidly as pH declines further. Arsenic provides an indication of how a heavy oxyanion is affected by changes in pH.

In order to obtain average leaching rates, typical trends have been recognized and average rates calculated for common qualitative leaching features or “conditions” as summarized in Table 3. In these definitions, “stable” means typically neither clearly increasing or decreasing. Due to variability in the testwork results, the definitions are not strict and require some flexibility in interpretation. For example, the transition from Condition 1 to 2 may not occur exactly at pH 7.

Condition 2 is typically accompanied by increasing release of cobalt and nickel which may continue into Condition 3. Lower pH (less than 6) typically occurs during Condition 3 and 4. In some cases, pH recovery is observed during Condition 4 as oxidation rates decrease.

Table 2. List of Rock Humidity Cells

HCT ID	Comment	Original Waste Type	Geological Unit	Rock Type	Category	Sample ID	S %	Initial Date	Data Record Length weeks	Duration Used in Current Modeling <sup>2</sup> weeks
1	9 Dup	RWR	1	Anorthositic	1	99-320C(830-850)	0.09	8/8/2005	337	284
3		RWR	1	Anorthositic	1	00-361C(345-350)	0.05	8/8/2005	337	284
26		NRWR	2	Anorthositic	1	00-366C(185-205)	0.02	8/9/2005	198	198
27		NRWR	2	Anorthositic	1	00-366C(230-240)	0.02	8/9/2005	198	198
28		NRWR	2	Anorthositic	1	99-320C(165-175)	0.03	8/9/2005	198	198
40		NRWR	3	Anorthositic	1	00-334C(30-50)	0.02	8/9/2005	337	284
41	37 Dup	NRWR	3	Anorthositic	1	00-368C(125-145)	0.04	8/10/2005	337	284
42		NRWR	3	Anorthositic	1	00-368C(20-40)	0.04	8/10/2005	198	198
13		NRWR	1	Troctolitic	1	00-340C(595-615)	0.04	8/10/2005	198	198
14		NRWR	1	Troctolitic	1	00-334C(580-600)	0.06	8/15/2005	336	284
15		RWR	1	Troctolitic	1	00-334C(640-660)	0.07	8/8/2005	337	284
16		RWR	1	Troctolitic	1	00-347C(795-815)	0.07	8/8/2005	198	198
29		NRWR	2	Troctolitic	1	99-318C(250-270)	0.04	8/9/2005	198	198
30		NRWR	2	Troctolitic	1	00-373C(95-115)	0.04	8/9/2005	198	198
31		NRWR	2	Troctolitic	1	00-373C(75-95)	0.06	8/9/2005	198	198
32		RWR	2	Troctolitic	1	00-357C(110-130)	0.08	8/9/2005	198	198
33		RWR	2	Troctolitic	1	99-320C(315-330)	0.07	8/9/2005	337	284
43		NRWR	3	Troctolitic	1	00-366C(35-55)	0.02	8/10/2005	198	198
44		NRWR	3	Troctolitic	1	00-334C(110-130)	0.04	8/10/2005	198	198
45		NRWR	3	Troctolitic	1	00-347C(155-175)	0.06	8/10/2005	198	198
46		RWR	3	Troctolitic	1	00-347C(280-300)	0.06	8/10/2005	198	198
49		NRWR	4	Troctolitic	1	00-367C(50-65)	0.03	8/10/2005	198	198
50		NRWR	4	Troctolitic	1	00-367C(260-280)	0.04	8/10/2005	198	198
51	57 Dup	NRWR	4	Troctolitic	1	00-367C(290-310)	0.04	8/10/2005	337	284
52		RWR	4	Troctolitic	1	00-370C(20-30)	0.08	8/10/2005	198	198
56		NRWR	5	Troctolitic	1	26064(44-54)	0.02	8/10/2005	337	284
59		NRWR	5	Troctolitic	1	26064(264+146-269+156)	0.06	8/10/2005	337	284
60		NRWR	6	Troctolitic	1	26056(110-125)	0.04	8/10/2005	198	198
74		NRWR	1	Troctolitic	1	26029(815-825)	0.02	9/8/2005	194	194
78		NRWR	6	Troctolitic	1	26056(135-153)	0.05	9/22/2005	331	278
99		LeanOre	1	Troctolitic	1	00-326C(250-265)	0.08	10/28/2005	187	186
21		RWR	1	Ultramafic	1	00-357C(335-340)	0.08	8/9/2005	198	198
35		NRWR	2	Ultramafic	1	00-368C(460-465)	0.06	8/9/2005	198	198
36		NRWR	2	Ultramafic	1	26055(940-945)	0.06	8/9/2005	198	198
39		NRWR	2	Ultramafic	1	26098+00-337C	0.1	8/9/2005	198	198
72	61 Dup	LeanOre	2	Ultramafic	1	00-361C(240-245)	0.06	8/11/2005	337	284
101		LeanOre	2	Ultramafic	1	26039(310-315)	0.06	10/28/2005	187	186
2		RWR	1	Anorthositic	2/3	00-361C(310-320)	0.18	8/8/2005	337	284
103		LeanOre	1	Anorthositic	2/3	99-320C(400-405)	0.18	10/28/2005	326	273
5		RWR	1	Sed Honfels	2/3	26030(1047-1052)	0.24	8/8/2005	337	284
6		RWR	1	Sed Honfels	2/3	26061(1218-1233)	0.44	8/8/2005	337	284
7		RWR	1	Sed Honfels	2/3	00-340C(990-995)	0.55	8/8/2005	337	284
17		RWR	1	Troctolitic	2/3	00-350C(580-600)	0.19	8/8/2005	337	284
18		RWR	1	Troctolitic	2/3	00-327C(225-245)	0.44	8/8/2005	198	198
34		RWR	2	Troctolitic	2/3	00-369C(335-345)	0.18	8/9/2005	337	284
47		RWR	3	Troctolitic	2/3	00-326C(60-70)	0.14	8/10/2005	337	284
48	38 Dup	RWR	3	Troctolitic	2/3	00-369C(305-325)	0.25	8/10/2005	198	198
53		RWR	4	Troctolitic	2/3	00-369C(20-30)	0.21	8/10/2005	337	284
54		RWR	4	Troctolitic	2/3	00-367C(170-175)	0.51	8/10/2005	337	284
71		LeanOre	2	Troctolitic	2/3	00-340C(380-390)	0.15	8/11/2005	198	198
75		LeanOre	3	Troctolitic	2/3	26049+26030	0.59	8/11/2005	198	198
77		LeanOre	5	Troctolitic	2/3	26056(302-312)	0.23	8/11/2005	337	284
80		LeanOre	6	Troctolitic	2/3	26142(360+345-365+350)	0.18	8/11/2005	337	284
96		LeanOre	2	Troctolitic	2/3	99-318C(325-330)	0.17	10/28/2005	326	273
98		LeanOre	5	Troctolitic	2/3	26056(282-292)	0.32	10/28/2005	187	186
100		LeanOre	1	Troctolitic	2/3	00-340C(910-925)	0.36	10/28/2005	326	273
102		LeanOre	1	Troctolitic	2/3	00-331C(190-210)	0.42	10/28/2005	326	273
105		LeanOre	3	Troctolitic	2/3	00-367C(495-500)	0.28	10/28/2005	326	273
22		RWR	1	Ultramafic	2/3	00-326C(680-685)	0.30	8/9/2005	198	198
23		RWR	1	Ultramafic	2/3	00-357C(535-540)	0.2	8/9/2005	337	284
94		LeanOre	1	Ultramafic	2/3	00-344C(630-635)	0.34	10/28/2005	187	186
95		LeanOre	1	Ultramafic	2/3	00-326C(495-505)	0.16	10/28/2005	187	186

<sup>2</sup> Waste Characterization Data Package Version 9 (July 3 2012).

HCT ID	Comment	Original Waste Type	Geological Unit	Rock Type	Category	Sample ID	S %	Initial Date	Data Record Length weeks	Duration Used in Current Modeling <sup>2</sup> weeks
104		LeanOre	2	Ultramafic	2/3	00-326C(225-235)	0.12	10/28/2005	326	273
4		RWR	1	Anorthositic	4	00-343C(240-250)	0.68	8/8/2005	198	198
65		LeanOre	1	Anorthositic	4	26027(616-626)	1.83	8/11/2005	337	284
93		LeanOre	1	Anorthositic	4	00-331C(255-260)	0.86	10/28/2005	326	273
8		RWR	1	Sed Honfels	4	00-340C(965-974.5)	1.74	8/8/2005	198	198
11		RWR	1	Sed Honfels	4	26043+26027	2.47	8/8/2005	337	284
68		LeanOre	1	Sed Honfels	4	26062+26026	4.46	8/11/2005	337	284
106		LeanOre	1	Sed Honfels	4	26058(704-715)	1.46	10/28/2005	326	273
19		RWR	1	Troctolitic	4	00-371C(435-440)	0.88	8/8/2005	337	284
20	10 Dup	RWR	1	Troctolitic	4	00-340C(765-780)	1.68	8/8/2005	337	284
55		RWR	4	Troctolitic	4	00-367C(395-400)	0.77	8/10/2005	198	198
69		LeanOre	1	Troctolitic	4	00-340C(725-745)	0.91	8/11/2005	198	198
76		LeanOre	4	Troctolitic	4	00-367(400-405)	1.37	8/11/2005	198	198
24		RWR	1	Ultramafic	4	99-318C(725-735)	0.72	8/9/2005	198	198
25		RWR	1	Ultramafic	4	99-317C(460-470)	1.24	8/9/2005	198	198
70		LeanOre	1	Ultramafic	4	00-344C(515-520)	1.2	8/11/2005	198	198
97		LeanOre	1	Ultramafic	4	00-330C(275-280)	0.75	10/28/2005	187	186
62		RWR	20	Virginia	4	00-361C(737-749)	2	8/11/2005	337	284
63	58 Dup	RWR	20	Virginia	4	00-364C(210-229)	3.79	8/11/2005	198	198
64		RWR	20	Virginia	4	00-337C(510-520)	5.68	8/11/2005	198	198
66		Ore			-	P10	0.86	9/8/2005	333	268
67		Ore			-	P20	0.9	9/8/2005	333	268
73		Ore			-	P30	0.86	9/8/2005	333	268

Source: G:\PolyMet Mining\1UP005.01\_Northmet\_project\_2004\Reports\2012-06\_RS82\_Kinetic Update\Tables\RateCompilation\_1UP005001\_SJD\_VER03\_20110204\_NoLinks.xlsx]

**Table 3. Qualitative Definition of Leaching Conditions**

Condition	Trend Features
1	pH>7, stable SO <sub>4</sub>
2	pH<7, typically stable SO <sub>4</sub>
3	SO <sub>4</sub> sharply increasing and unstable
4	SO <sub>4</sub> peaked and decreasing

## 3.2 Description of Results by Waste-Rock Category

### 3.2.1 Category 1

Results for pH, sulfate, nickel, copper and arsenic are shown in Figure 1.

All Category 1 humidity cells have yielded pH above 6 throughout the program. Generally, pHs declined as the tests proceeded. Initial pHs in most cases were above 8 but declined rapidly and have typically fluctuated between 6.5 and 7.5. There is no indication for the 12 continuing tests that pHs are on a declining trend. In a few cases, pHs have recovered slightly. At the same time, the alkalinity trend is stable.

Sulfate leaching rates have been low throughout the program with most continuing tests showing rates below 1 mg/kg/week. At these low rates, variability in trends is apparent but no clear upward trends have been apparent.

Nickel showed slight increases in leaching rates relative to other tests in the few cells in which pH decreases and peak nickel leaching rates were observed in cell 99-320C(830-850). This sample also showed the highest sulfate and cobalt leaching rates. Copper generally showed stable leaching rates.

Arsenic showed no increase in leaching rates due to pH changes. Arsenic leaching has either stabilized or decreased steadily.

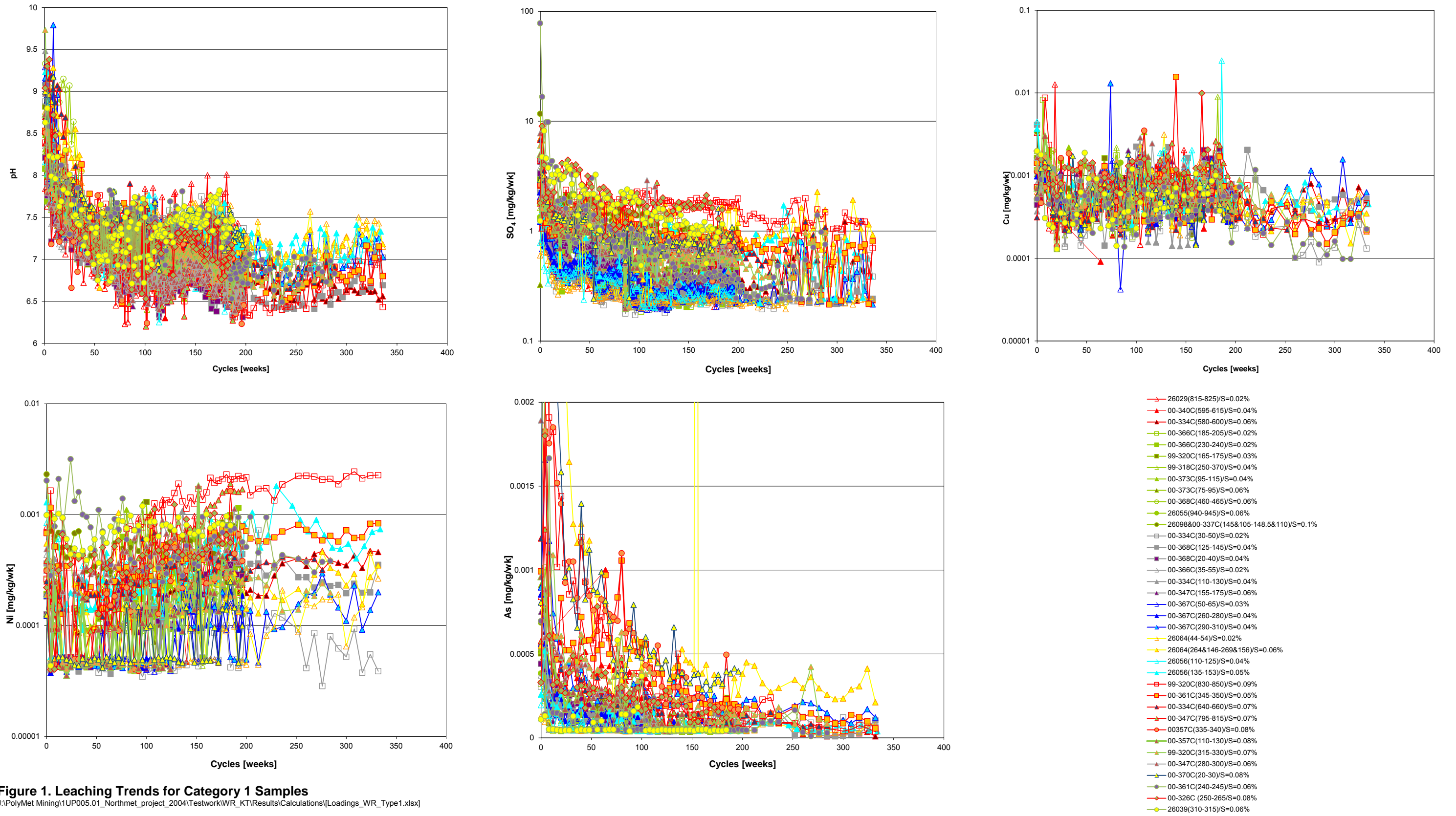

**Figure 1. Leaching Trends for Category 1 Samples**

J:\PolyMet Mining\1UP005.01\_Northmet\_project\_2004\Testwork\WR\_KT\Results\Calculations\Loadings\_WR\_Type1.xlsx

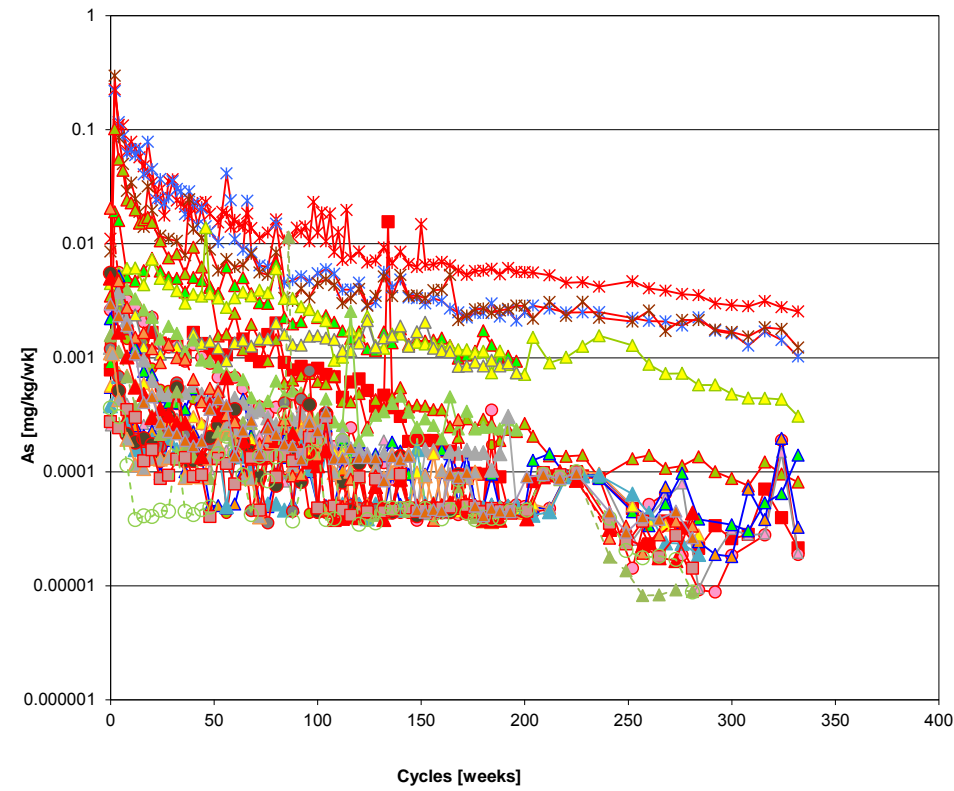
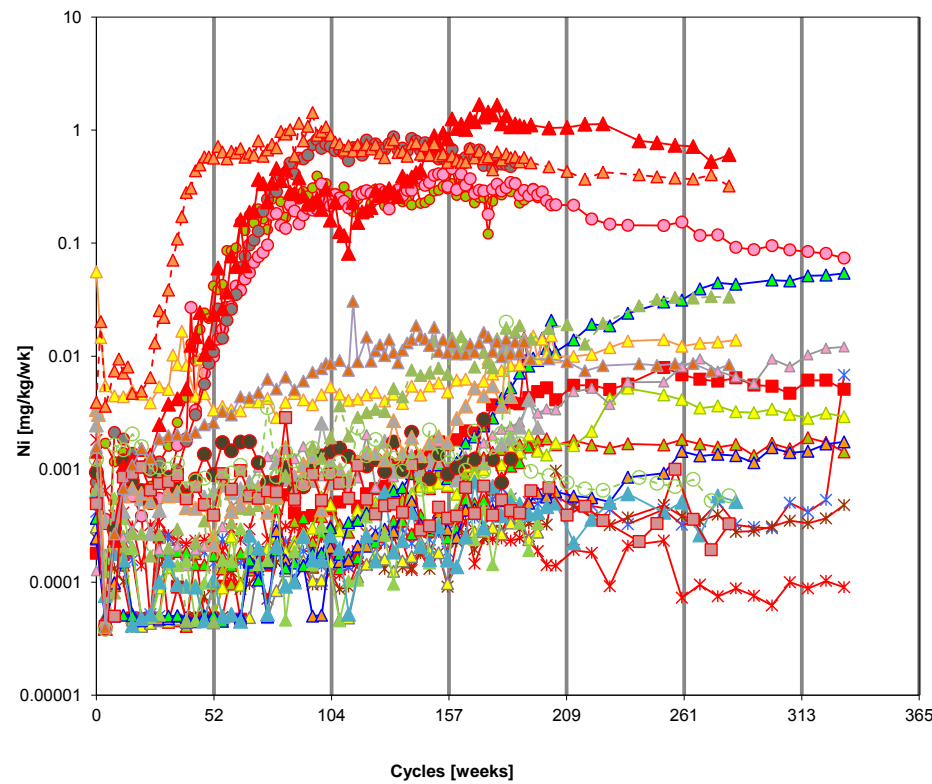
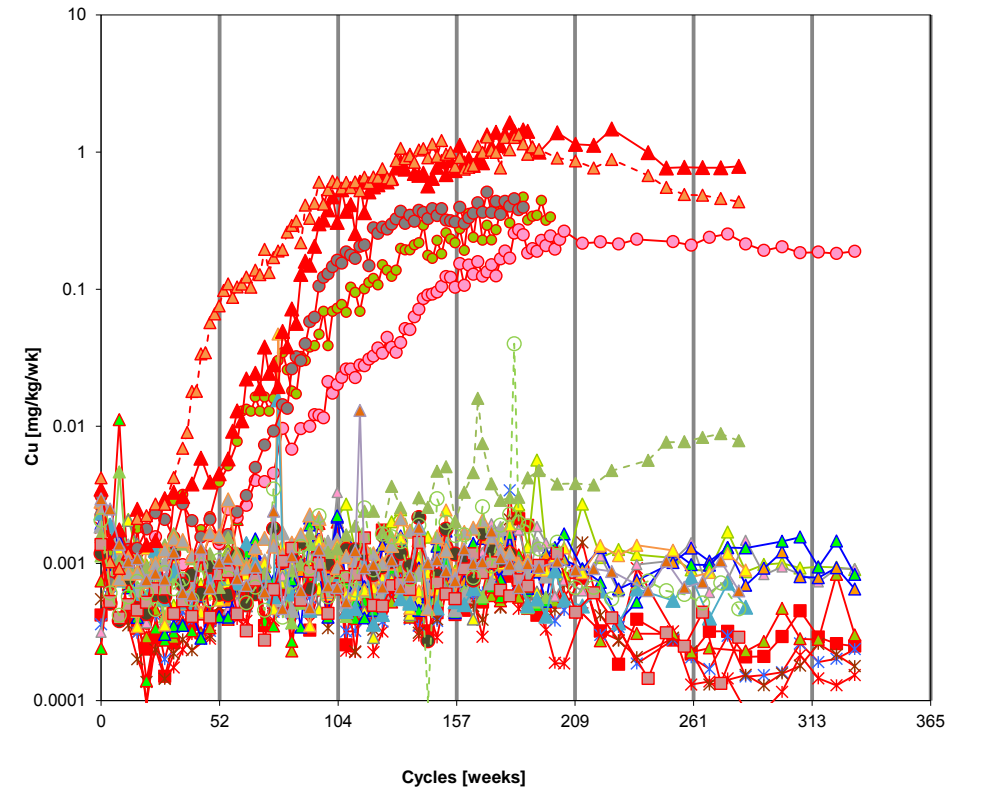
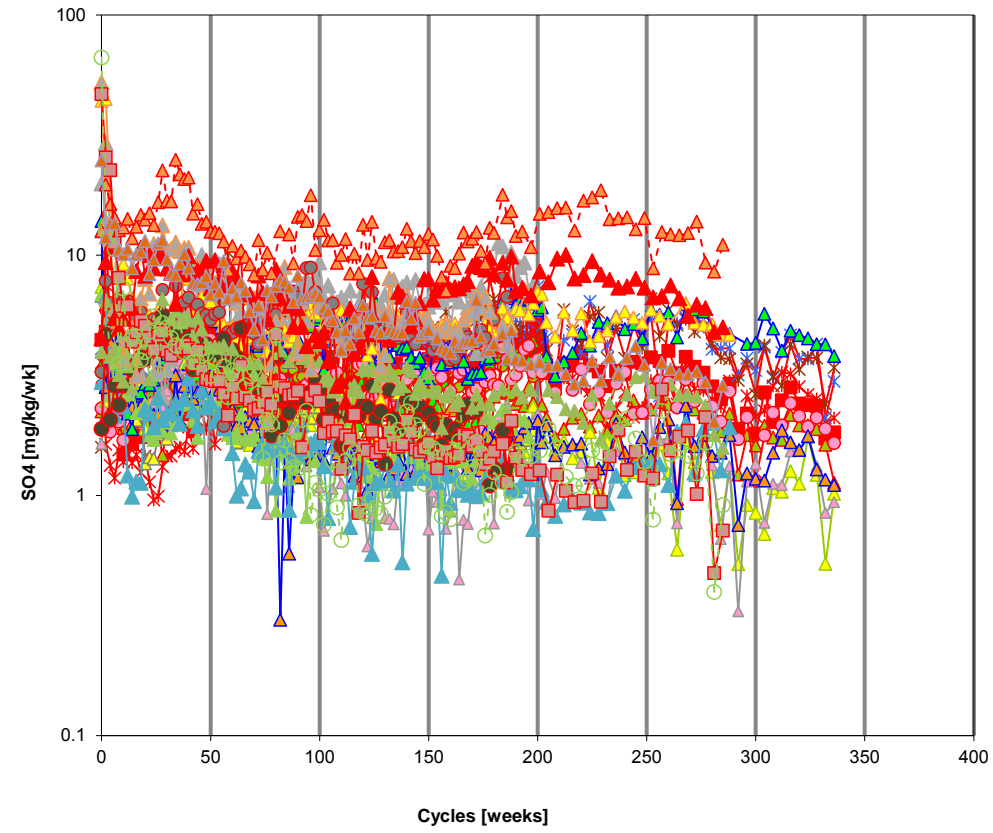
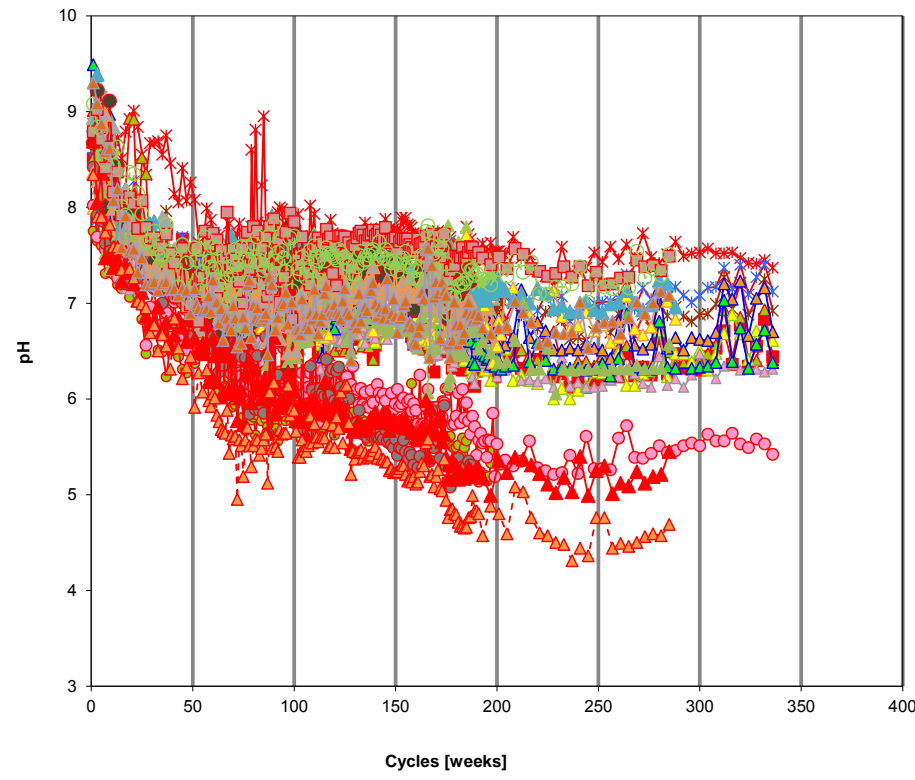

- 00-361C(310-320)/S=0.18%
- 26030(1047-1052)/S=0.24%
- 26061(1218-1233)/S=0.44%
- 00-340C(990-995)/S=0.55%
- 00-350C(580-600)/S=0.19%
- 00-327C(225-245)/S=0.44%
- 00326C(680-685)/S=0.3%
- 00-357C(535-540)/S=0.2%
- 00-369C(335-345)/S=0.18%
- 00-369C(305-325)/S=0.25%
- 00-326C(60-70)-4/S=0.14%
- 00-369C(20-30)/S=0.21%
- 00-367C(170-175)/S=0.51%
- 00-340C(380-390)/S=0.15%
- 26030&26049(291&358-296&362)/S=0.59%
- 26056(302-312)/S=0.23%
- 26142(360&345-365&350)/S=0.18%
- 00-344C(630-635)/S=0.34%
- 00-326C(495-505)/S=0.16%
- 99-318C(325-330)/S=0.17%
- 26056(282-292)/S=0.32%
- 00-340C(910-925)/S=0.36%
- 00-331C(190-210)/S=0.42%
- 99-320C(400-405)/S=0.18%
- 00-326C(225-235)/S=0.12%
- 00-367C(495-500)/S=0.28%

**Figure 2. Leaching Trends for Category 2/3 Samples**

G:\PolyMet Mining\1UP005.01\_Northmet\_project\_2004\Testwork\WR\_KT\Results\Calculations\Loadings\_WR\_Type\_2\_3.xlsx



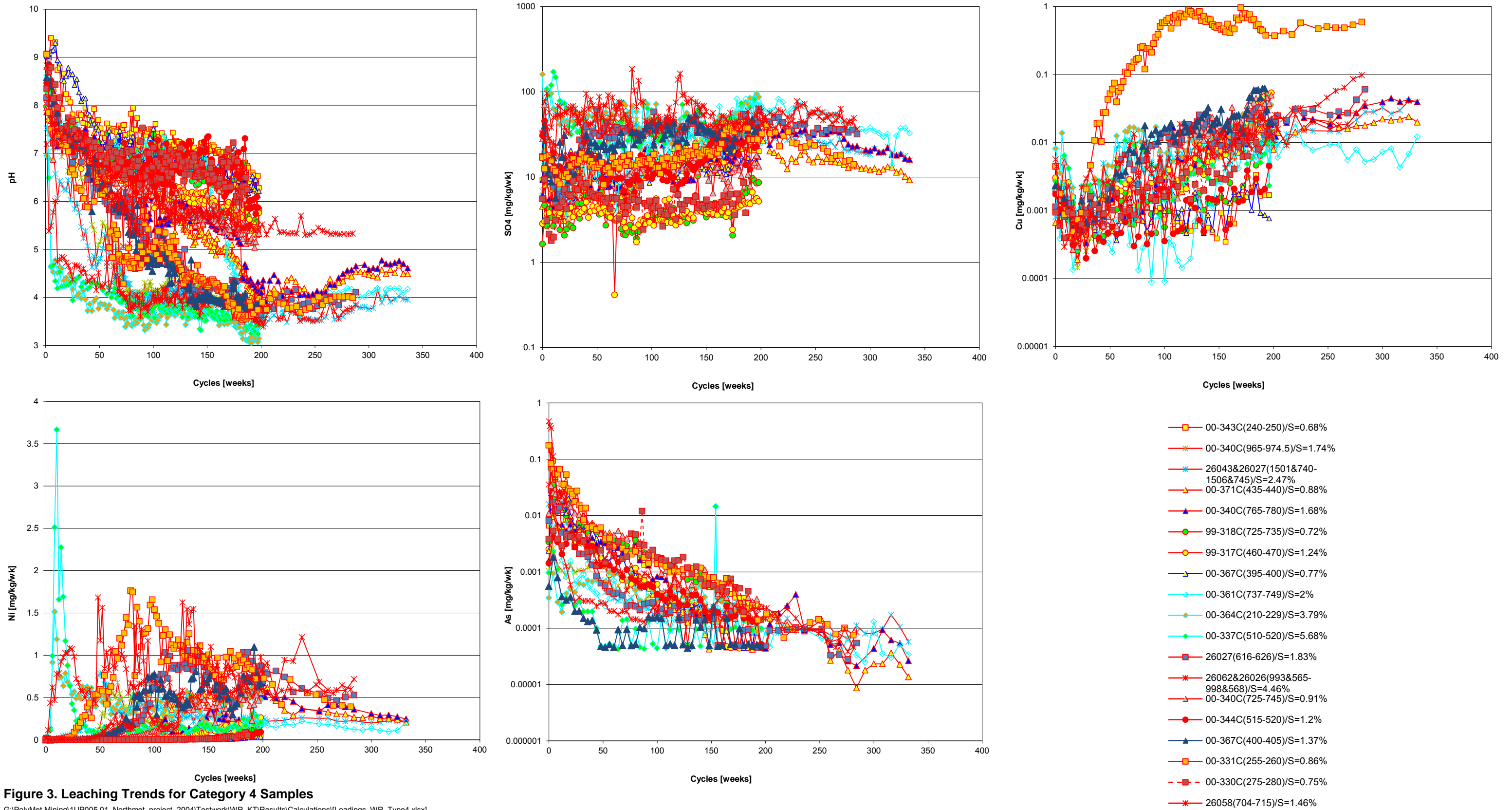

**Figure 3. Leaching Trends for Category 4 Samples**

G:\PolyMet Mining\1UP005.01\_Northmet\_project\_2004\Testwork\WR\_KT\Results\Calculations\Loadings\_WR\_Type4.xlsx

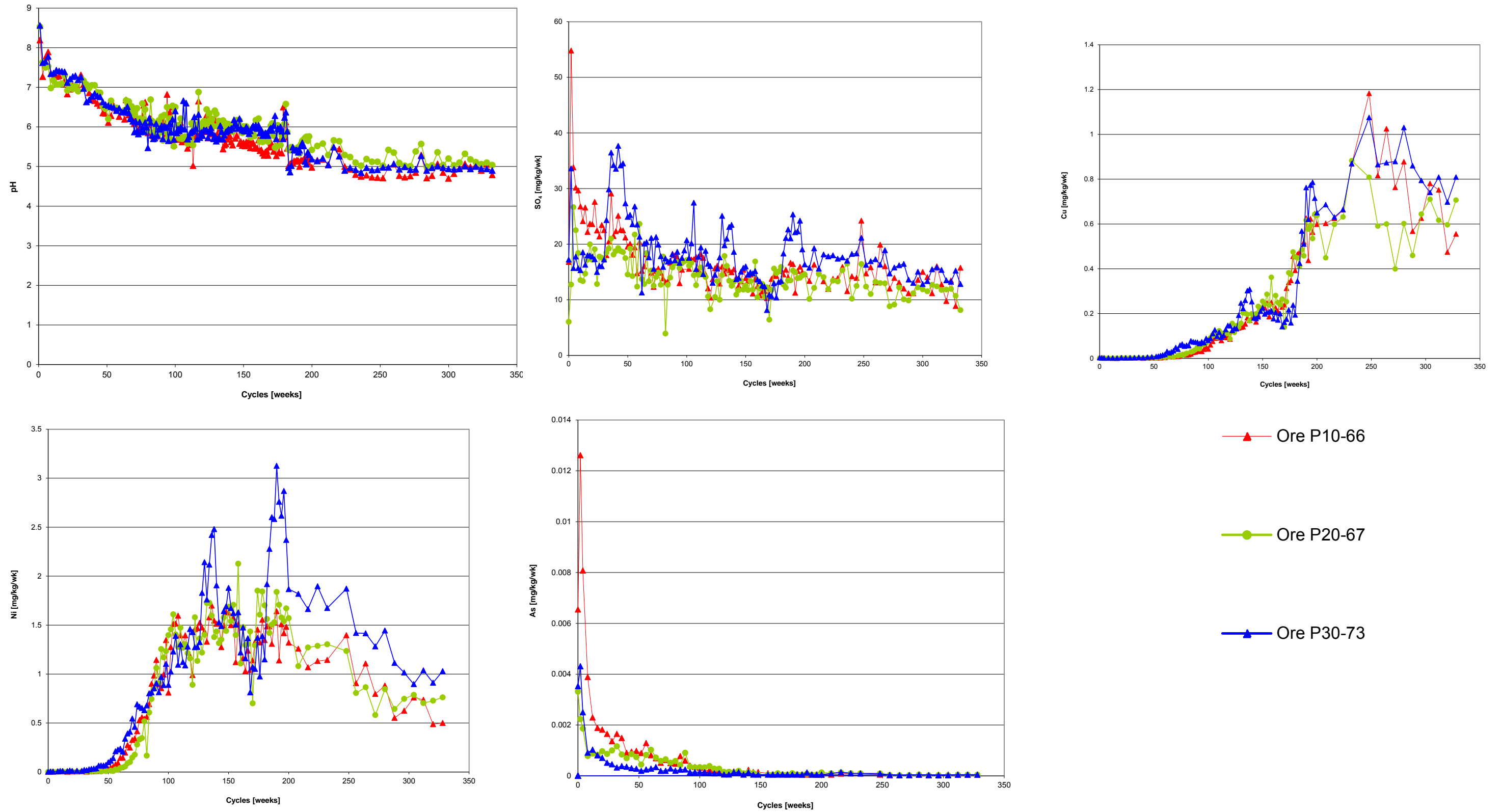

**Figure 4. Leaching Trends for Ore Composite Samples**

G:\PolyMet Mining\1UP005.01\_Northmet\_project\_2004\Testwork\WR\_KT\Results\Calculations\loadings\_Ore.xlsx

Testing on Category 1 samples has confirmed to date that alkalinity generated by weathering of silicate minerals is able to result in pH above the pH of de-ionized water. This indicates that the alkalinity is consuming acidity introduced by both the dissolved CO<sub>2</sub>, introduced by the deionized water (pH 5 to 6), and acidity produced by oxidation of sulfide minerals (locally pH<4). The steady maintenance of pHs above 6 shows that this is a steady long term mechanism for preventing pH depression below 6 in humidity cells.

### 3.2.2 Category 2/3

Results for pH, sulfate, nickel, copper and arsenic are shown in Figure 2.

Five samples (including three of the continuing 19 samples) showed pH depression below 6 while all other samples have shown stable pHs above 6 with similar trends to the Category 1 samples. Only one of the six samples has shown pH below 5. The sulfur content of the five samples varied from 0.2% to 0.42%. The sample with 0.2% sulfur showed the highest pH in this set at near 5.5. The sulfur contents of the other four samples were 0.3% and higher.

Sulfate release for Category 2/3 samples varied between 1 and 10 mg/kg/week with the highest rates being observed for samples containing higher sulfur contents. While sulfate release has varied, there was a lack of consistent upward trends.

A number of samples showed upwards trends in nickel and cobalt were related to pH decrease below 7. For the five samples showing distinctive pH depression, nickel release increased steeply during the first year of testing and subsequently showed gentle decline. Other samples showed slower nickel increase later in the program due to slower decline in pH. The same five samples also showed increase in copper leaching though the increase was less rapid than nickel and decline occurred later or not at all. One other sample (99-318C-325-330) showed accelerated copper leaching. Leachate pH was at the low end of those samples not showing substantial pH depression. It is a lean ore sample containing 0.1% copper.

Arsenic leaching trends were similar to Category 1. Rates have trended downwards. Higher rates are associated with samples yielding higher leachate pHs.

### 3.2.3 Category 4

Results for pH, sulfate, nickel, copper and arsenic are shown in Figure 3. Eight tests are continuing, two of which are Duluth Complex troctolite samples (00-371C(435-440) and 00-340C(765-780)), two are Duluth Complex Anorthositic Troctolites (00-331C (255-260) and 26027(616-626)), three are sedimentary hornfels samples (26058 (704-715), 26043&26027(740&1501-745&1506)) and DDH-26062&26026(993&565-998&568)-68) and one is Virginia Formation (00-361C(737-749)).

All tests have shown pH depression to some degree with pHs below 4. Of the continuing tests, one sedimentary hornfels sample (26058-704-715) showed the least depression with stable pHs near 5.3. The other samples showed leachate pHs near or below 4 and have recently shown pH recovery from minimum values. The two troctolite samples have shown pHs above 4.5 following a steep decline to pH near 4 earlier in the program. The other two Duluth Complex samples, Virginia Formation sample and other sedimentary hornfels samples have shown weaker pH recovery. Stabilization at pHs between 4 and 5 are indicative of buffering by reaction of acidity with aluminosilicate minerals resulting in formation of secondary aluminum minerals.

Some increases in sulfate release have been observed as pH decreased. Peak sulfate release rates have typically been less than a factor of five times lowest levels earlier in the test and peaks are not sharp but erratic. Decline in sulfate release has been observed following the peak. These declines are rapid at first then lessen as shown by straight lines on the log axis plot.

Due to the consistent pH depression below 7, all samples showed accelerated nickel leaching followed by declining leaching after reaching a subdued peak. All continuing tests have shown this decline parallels the sulfate release trend implying that nickel release is derived from sulfide minerals. Cobalt showed similar trends.

Upward trends in copper release were also apparent for all tests but as observed for acidifying Category 2/3 samples, the increase in copper release occurred later than nickel. Also, peaks followed by downward trends in copper release were less apparent for nickel and most ongoing tests have shown increase in copper release rather than a decrease paralleling nickel and sulfate release.

As with all other tests, arsenic release followed a declining trend.

#### 3.2.4 Ore Composites

Results for pH, sulfate, nickel, copper and arsenic are shown in Figure 4.

Leachate pH trends for the three samples are nearly identical and show pH has been stable near 5 for over 2 years. Likewise, sulfate release has been similar for all three tests and has not shown consistent upward or downward trends. As pH decreased, nickel release accelerated, reaching peak rates after about three years then declining. Composite P30 showed a marked separate pH after 4 years that was not apparent in the other tests. A sulfate release peak was observed about the same time though was less pronounced compared to the other two tests.

Copper release also increased as the tests progressed but the upward trend was delayed compared to nickel and reached peak values after more than 4 years of testing. Copper release has subsequently declined.

### 3.3 Comparison Tests

Five samples tested as four size fractions continue to be tested in parallel with the humidity cell program. These tests are comparing differences in the weathering characteristics of the samples as well as differences in testing configuration (ASTM Humidity Cell and DNR Reactor) Samples are classified as Category 1 (two samples), Category 2/3 (two samples) and Category 4 (1 samples).

Both Category 1 samples have yielded leachate pHs near 7 in all size fractions and flat sulfate release trends. Sulfate release continues to be a function of particle size with lowest release (when detected) coming from the coarser size fractions. Similar findings apply to metal release. Nickel release is greater for the finer size fractions.

Consistent with the conventional humidity cells for Category 2/3 samples, lower pHs were observed but due to the sulfur content near 0.2% for both samples, pHs have remained above 6 and the samples continue to generate alkalinity particularly from the finer size fractions. Sulfate release was variable for both samples and no trends were apparent. Difference between sulfate releases in size fractions was most apparent for one sample (00-361C-310-320) with the fine fractions releasing higher sulfate than the coarse fraction. Both samples showed accelerated nickel leaching from all fractions as pH decreased below 7. Differences between size fractions were strongest for 00-361C-310-320. Temporal trends in copper release were not apparent but copper release rates were greater for the finer size fractions.

Virginia Formation rock classified as Category 4 showed sharp decline in pH to near and below 3.5 in all size fractions. Peak sulfate release was observed around 4 years for the two fine fractions. Peak sulfate release rates for the coarsest fractions have not observed because rates began increasing after six years. These differences in timing were not linked to greater pH depression for the fine fractions, in fact, the finer fractions yielded higher pHs.

These tests have shown that:

- Testing of different size fractions to date has shown that samples generating acidic leachate did so regardless of size fraction tested and protocol used.
- Rates of sulfate and metal release are generally higher for the finer size fractions presumably reflecting differences in surface area.
- For one sample that became strongly acidic, the finer fractions showed more rapid sulfate release earlier than the coarse fractions presumably reflecting faster oxidation and greater liberation of sulfide minerals.

### 3.4 Duplicate Testwork

Following observation of good reproducibility of trends previously (SRK 2009), all seven standard humidity cell tests being run as duplicates were stopped as part of reduction of the program in consultation with the DNR. Duplicate DNR reactor tests on two samples, and duplicate humidity cells containing size fractions for two samples have continued for a total of four duplicates (eight tests).

The two humidity cell-style duplicates are continuing to show strong reproducibility for the major ions and trace elements of interest (arsenic cobalt, copper, nickel). Weak reproducibility was apparent for barium (one sample).

The DNR-style reactors showed good reproducibility for one sample and poor reproducibility of pH for the other sample. The difference in pH (near 6 compared to 6.5) appeared to be due to differences in oxidation rate (faster for lower pH) which also resulted in greater leaching rates for cobalt and nickel.

### 3.5 Interpretation

#### 3.5.1 Effect on Sulfur Management Criteria

Figure 5 shows minimum leachate pH as a function of total sulfur content for all humidity cell tests. Lowest pHs are observed for samples containing highest sulfur concentrations (Virginia Formation and Sedimentary Hornfels). The lowest sulfur concentration showing pH depression below 5 (i.e. below the range of pH of deionized water used in the test) was 0.36%. Samples with sulfur content below the Category 1 threshold of 0.12% have shown leachate pH above 6 indicating the threshold is appropriate based on current data.

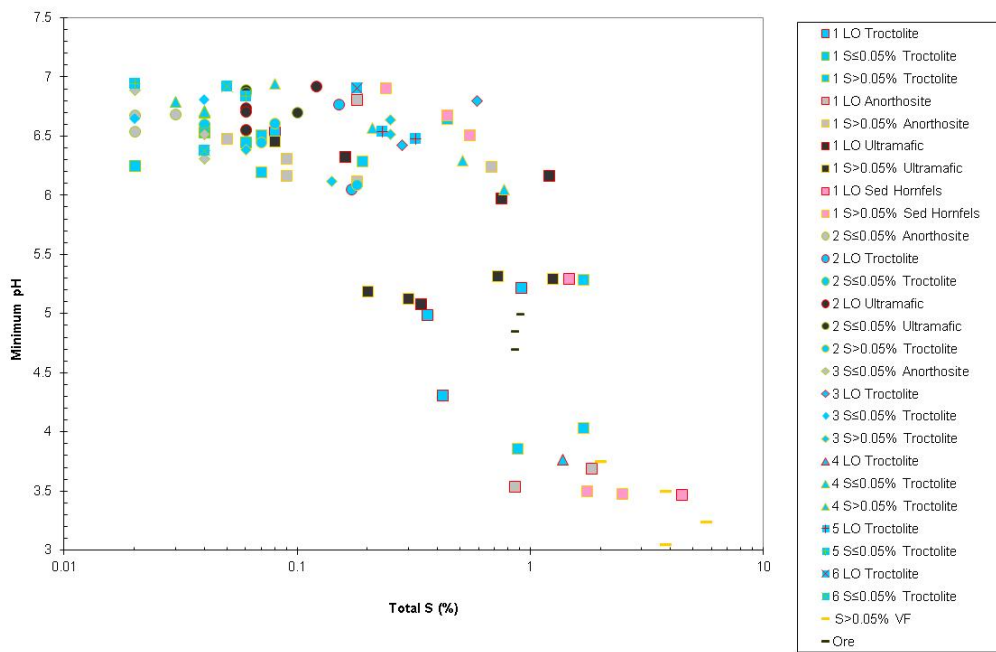
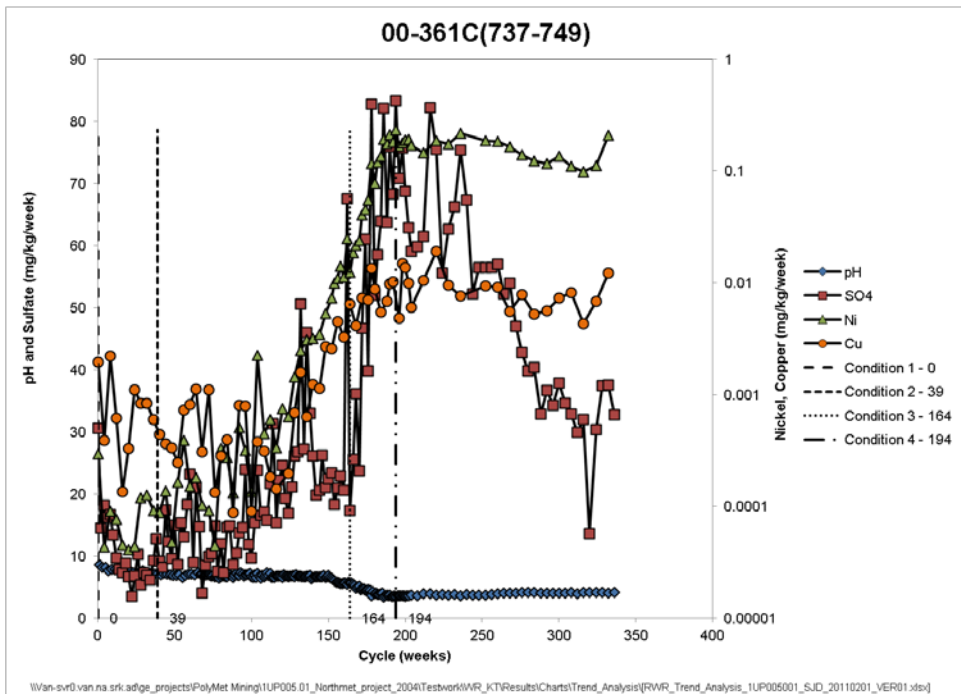

**Figure 5. Minimum Leachate pH as a Function of Total Sulfur Content**

#### 3.5.2 Effect on Dissolution Rates Used to Estimate Water Quality

The condition definitions shown in Table 3 were used to assess trends for each test.

An example for one test showing all four conditions is provided in Figure 6. Condition 1 lasted for 39 weeks and was marked higher pHs and relatively stable SO<sub>4</sub> following an initial flush in the first few weeks. As pHs declined below 7, sulfate in this case become more variable and leaching of nickel accelerated. Condition 3 began at week 164 and was marked by steep decline in pH to 3.5 and rapidly increasing sulfate release paralleled by nickel. Condition 4 began at week 194 when sulfate release peaked and then began to declining.



**Figure 6. Example of Condition Assignment for a Waste Rock Humidity Cell Test**

Resulting rates for each condition have been provided to Barr Engineering and include data collected to late January and early February 2012. These may be used as the basis for various inputs to source term predictions for the water quality model. However, the updated rate table primarily adds a few rates for samples that transitioned to acidic conditions. The majority of samples leaching under non-acidic conditions continue to show stable rates that have not changed significantly. As a result of this finding, there is likely little incremental value in modifying the rates used as inputs to the water quality modeling.

## **4 Tailings Kinetic Tests**

### **4.1 Status of Program**

A review of the tailings program was provided recently (SRK 2011). All tests have continued since findings were reported resulting in about six months of additional data. As this represents less than 15% additional time for most tests (with the exception of tests started in 2009), this memorandum provides a limited review to indicate whether any significant changes have occurred since the previous review.

### **4.2 Description of Results**

#### **4.2.1 NorthMet Project Tailings**

Table 3 lists all tailings humidity cells. The test program consists of conventional humidity cells with parallel tests using the MDNR reactor configuration on bulk tailings and tailings size fractions.

Tests started in 2005 and 2006 (Pilot Plant 1) have continued to the same trends reported by SRK (2011) including stable or increasing pH, decreasing sulfate and stable or decreasing metal concentrations.

Tests started in 2008 (Pilot Plants 2 and 3) have reached stable pH with no indication of trends below pH 7 as shown in some samples produced by Pilot Plant 1. Sulfate release has stabilized for all tests. Nickel and cobalt release have not shown the same trends as Pilot Plant 1 samples but have shown stable concentrations in leachates below 0.002 mg/L and 0.0001 mg/L, respectively. PP2 +100 mesh showed an arsenic spike to 0.08 mg/L at week 168 following repair of the cell to address rapid drainage of water during the leach cycle.

Tests started in 2009 (scavenger tailings samples) have shown downwards trends in pH with lowest pHs typically above 7. At the same time, sulfate release has also trended downward and for some tests has stabilized. Nickel and cobalt release trended downward initially for all tests. Upwards trends for both elements were most apparent for samples Oct 1/09 09:00 (-100+200 mesh) which also showed some pHs below 7.

An arsenic spike resembling those for the 2008 samples discussed above was also apparent for two cells. These spikes were correlated with a large number of spikes in other parameters including aluminum, iron and silicon. It appears the cell malfunctioned perhaps allowing solids to be present in the leachates and thereby causing an increase in the dissolved fraction due to the presence of colloidal matter.

**Table 4: Tailings Humidity Cells Used as Basis for Update Report**

HCT ID	Fraction	HCT Full ID	Total Sulfur (%)	Start Date	Total Duration weeks	Duration Used for Current Modeling <sup>3</sup> weeks
T1	Whole	P1 (CuSO4)	0.1	9/8/2005	333	--
T2	Whole	P1 (no CuSO4)	0.23	9/8/2005	333	--
T3	Whole	P2 (no CuSO4)	0.2	9/8/2005	333	--
T4	Whole	P3 (CuSO4)	0.15	9/8/2005	333	--
T5	100	Parcel 2 P2S +100 mesh	0.15	2/10/2006	311	--
T6	100	Parcel 2 P2S -100 +200 mesh	0.17	2/10/2006	311	--
T7	-200	Parcel 2 P2S -200 mesh	0.24	2/10/2006	311	--
T8	100	Parcel 1-2 PISCS +100 mesh	0.11	2/10/2006	311	271
T9	100	Parcel 1-2 PISCS -100 +200 mesh	0.1	2/10/2006	311	271
T10	-200	Parcel 1-2 PISCS -200 mesh	0.09	2/10/2006	311	271
T11	100	Parcel 3 P3S +100 mesh	0.11	2/10/2006	311	271
T12	100	Parcel 3 P3S -100 +200 mesh	0.14	2/10/2006	311	271
T13	-200	Parcel 3 P3S -200 mesh	0.14	2/10/2006	311	271
T52	Whole	Pilot Plant 2 (0.30 Cu feed) Composite Bulk Tailings (as rec'd)	0.07	7/8/2008	185	--
T53	100	Pilot Plant 2 (0.30 Cu feed) Composite (+100 mesh)	0.08	7/8/2008	185	146
T54	100	Pilot Plant 2 (0.30 Cu feed) Composite (-100 + 200 mesh)	0.06	7/8/2008	185	146
T55	-200	Pilot Plant 2 (0.30 Cu feed) Composite (-200 mesh)	0.09	7/8/2008	185	146
T56	Whole	Pilot Plant 3 (0.25 Cu feed) Composite Bulk Tailings (as rec'd)	0.08	7/8/2008	185	--
T57	100	Pilot Plant 3 (0.25 Cu feed) Composite (+100 mesh)	0.1	7/8/2008	185	146
T58	100	Pilot Plant 3 (0.25 Cu feed) Composite (-100 + 200 mesh)	0.08	7/8/2008	185	146
T59	-200	Pilot Plant 3 (0.25 Cu feed) Composite (-200 mesh)	0.08	7/8/2008	185	146
T60	Whole	SCAV TAILS 9/30/09 1600	0.09	11/24/2009	113	--
T61	100	SCAV TAILS 9/30/09 1600 +100	0.1	11/24/2009	113	74
T62	100	SCAV TAILS 9/30/09 1600 -100+200	0.09	11/24/2009	113	74
T63	-200	SCAV TAILS 9/30/09 1600 -200	0.11	11/24/2009	113	74
T64	Whole	SCAV TAILS 10/1/09 09.00	0.13	11/24/2009	113	--
T65	100	SCAV TAILS 10/1/09 09.00 +100	0.11	11/24/2009	113	74
T66	100	SCAV TAILS 10/1/09 09.00 -100+200	0.14	11/24/2009	113	74
T67	-200	SCAV TAILS 10/1/09 09.00 -200	0.14	11/24/2009	113	74
T68	Whole	SCAV TAILS 10/1/09 17.00	0.12	11/24/2009	113	--
T69	100	SCAV TAILS 10/1/09 17.00 +100	0.1	11/24/2009	113	74
T70	100	SCAV TAILS 10/1/09 17.00 -100+200	0.1	11/24/2009	113	74
T71	-200	SCAV TAILS 10/1/09 17.00 -200	0.13	11/24/2009	113	74

<sup>3</sup> Waste Characterization Data Package Version 9 (July 3 2012)



### 4.2.2 LTVSMC Tailings

Four samples of LTVSMC tailings are being tested in humidity cells. No significant changes in leachate chemistry have been observed since the previous update (SRK 2011). Leachate pHs have continued to vary in a narrow band between 7.4 and 8 with variable but non-trending alkalinity and sulfate.

Other parameters have continued to show no upward trend or downward trends. Isolated data spikes (for example, arsenic) are observed but do not represent significant trends.

### 4.3 Interpretation

Ongoing tailings testwork has shown no indication of development of pHs below that of the deionized water used to leach the samples (Figure 7) indicating that weathering of silicates minerals in the samples is continuing to generate alkalinity to offset acidity from sulfide oxidation and the deionized water even in the tests that have been operating for 7 years. The longer term tests yielded pH minima in their trends which are responsible for the lower pHs shown in Figure 7. Upward trends in pH are observed in most cases so that recent pHs are higher than the lowest values.

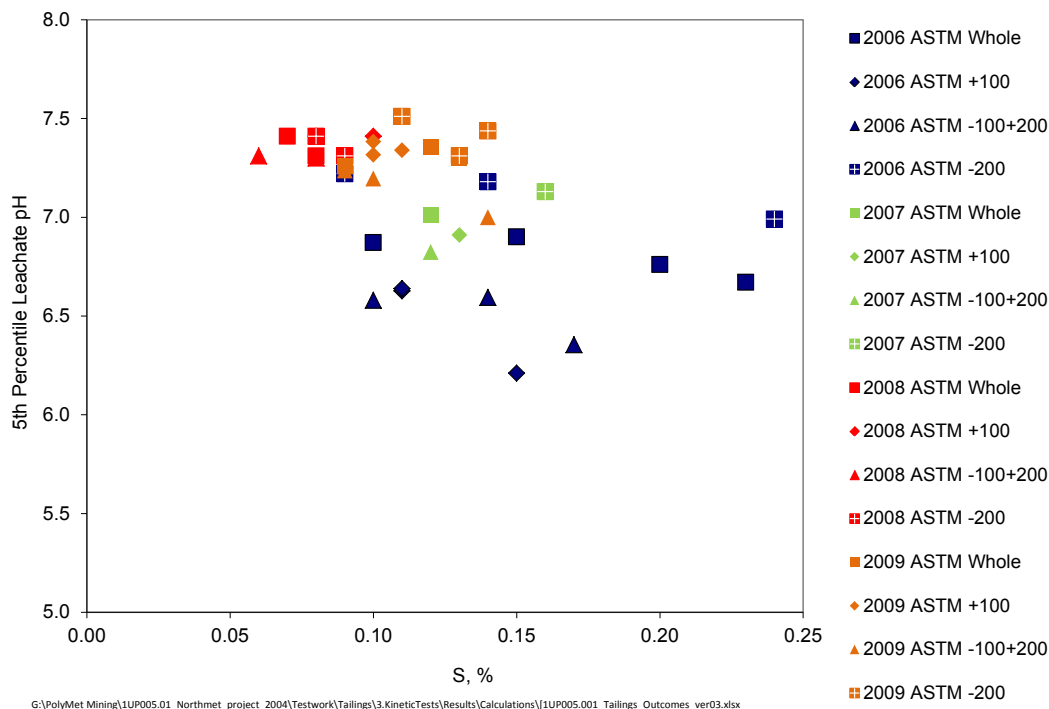

**Figure 7. 5<sup>th</sup> Percentile pH as a Function of Total Sulfur Content for Tailings Humidity Cells**

Correlations between initial total sulfur content and average release rates are apparent as have been observed previously (Figure 8). However, this figure suggests different relationships for the 2006 and 2007 datasets compared to the 2008 and 2009 datasets apparently implying that the earlier samples are less reactive. However, the differences are probably caused by significant depletion of sulfide as the tests have progressed with a correlated decrease in release rates, reducing the calculated average release rates. For example, between 30% and 78% of the initial sulfur has been depleted from the earlier tests compared to less than 30% for the more recent tests. For the oldest tests, remaining sulfur content varies from 0.04% to 0.12%. The general downward trend in sulfate release has resulted in progressively lower average sulfate release. The downward trend in sulfate release (and therefore acid generation rate) also provides a reasonable explanation for upward trends in pH.

The implication of results from the older tests is that the potential for long term pH depression below 5 is shown to be very low because silicate weathering was able to offset acid generation when sulfur content was higher than the current depleted levels.

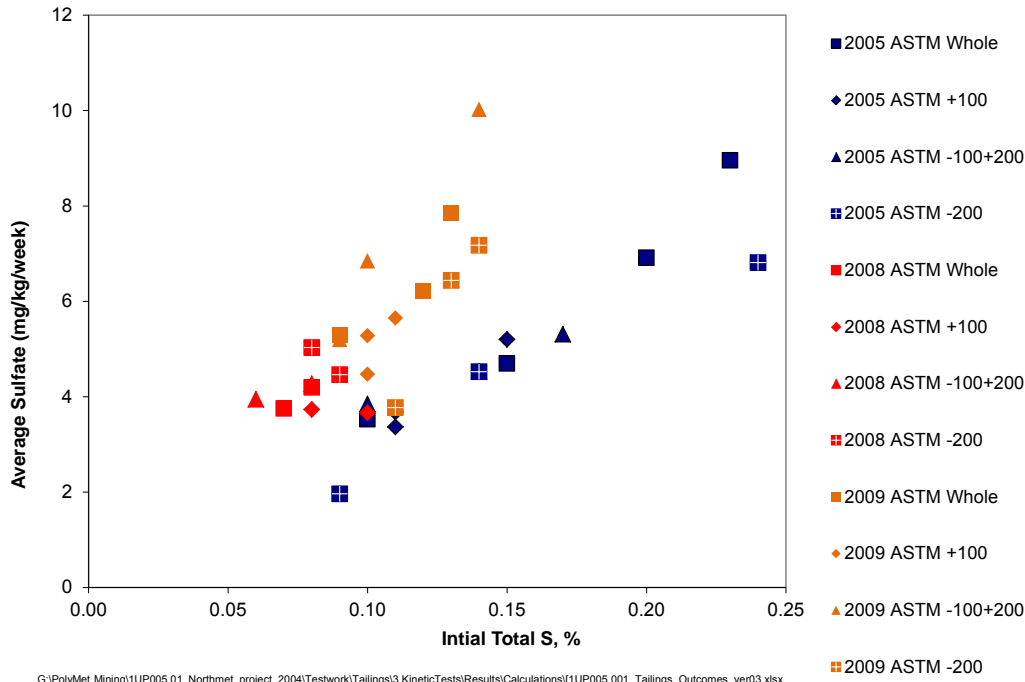

**Figure 8. Average Sulfate Release as a Function of Initial Total Sulfur Content**

The long term downward trend in sulfate release rates (Figure 9) indicates that average sulfate release rates for individual tests as used as input into the tailings water quality models are a function of time and will decrease as the test duration increases. To address this finding and provide sulfate release rates that are consistent with the assumed zero order reaction rate law for sulfide oxidation in the water quality model, relationships between sulfate release and sulfur depletion were examined to estimate sulfide oxidation rates at the initial sulfur content. The concept is to obtain the initial rates at  $t=0$  by regressing depleted sulfur content against sulfate release rates to obtain equations of the form:

$$\frac{dM_{SO_4}}{dt} = a_1 M_S + a_0$$

Graphs of sulfate release rate as a function of sulfur remaining showed three different relationships. The most common relationship (15 tests) was for the slope of the equation to be steeper at the start than in the longer term. Other trends were (1) initially lower rates followed by a peak then long term decay (about 6 tests); and (2) consistent slope for the duration of the test (12 tests).

The first type of relationship is commonly observed in humidity cell results and is interpreted as initial flushing of stored sulfate oxidation products followed by sulfide oxidation. The initial part of the trend therefore does not represent sulfide oxidation and should not be included in the regression equations to obtain the oxidation rate at  $t=0$ . The preferred approach is to use the data for each test on its own merit to evaluate the break point when leaching of stored oxidation products is complete and the long term decay trend is well-established. LAM MDNR disagreed with this approach and required that the regression equations be developed excluding the first 5 weeks of data based on the following commentary in the ASTM humidity cell method D5744-96, (Section 11.2):

“In the testing of mining wastes, cation and anion loadings are commonly high in the Week 0 leachate due to the dissolution of pre-existing soluble oxidation salts present in the sample prior to sample collection. The average number of weekly accelerated weathering cycles required to flush these pre-existing salts ranges from 3 to 5 weeks. Oxidation products observed during these 3 to 5 weeks are principally from pre-existing salts, while those

products observed after this period are considered to be solely a function of the accelerated weathering procedure.”

SRK does not agree with the use of a fixed initial flushing period because it is unlikely that this flushing process can be generalized. In reality, the period required to fully flush stored oxidation products depends on the types, solubility and quantity of the oxidation products, and the physical and mineralogical characteristics of the samples. Tailings samples also contain entrained process water which is expected to be soaked into the finer particles leading to a protracted initial flushing trend. Nonetheless, to advance the process of acceptance, the LAM MDNR requested method was adopted to calculate oxidation rates at  $t=0$ .

Graphs for all tests showing regression relationships using the MDNR method are provided in Attachment A

Figure 9 shows initial sulfate release (determined from the regression equation using the initial sulfide content of the sample) as a function of initial total S content of the samples for comparison with Figure 8. Initial sulfate release calculated using the MDNR and SRK methods is shown. The difference in rates between tailings samples generated by different pilot plants implied by Figure 8 is reduced by both methods but the DNR method appears to result in lower rates for the 2005 samples and a weaker correlation with sulfur content than the SRK method which eliminates differences between the different datasets. The similarity of rates implies that the tailings generated at different times have similar reactivity. Correlation between initial sulfur content and initial sulfate release is apparent when considering the entire data range though weaker at lower initial sulfur contents.

For the purpose of water quality modeling, the distribution of sulfate release rates will be based on the initial sulfate rates (Figure 9) calculated using the MDNR method as agreed. This method will result in the use of sulfide oxidation rates in the model that are nearly always higher than would actually be expected. Application of a single initial rate will result in predicted sulfate and trace element concentrations that are likely to be much higher than would really occur as sulfide content depletes over time. The approach is therefore conservative for predicting water quality.

For the purpose of modeling other parameters the following recommendations are made for rates:

- For parameters based on a solid ratio to sulfur content, rates should be calculated based on the ratios previously specified.
- For parameters based on average rate to average sulfate rate ratios (Ca, K, Mg, Na, Se), rates should be calculated based on the average rate ratio as previously specified. For the major ions, downward trends are apparent that parallel decrease in sulfate indicating that ratios of average rates are appropriate.

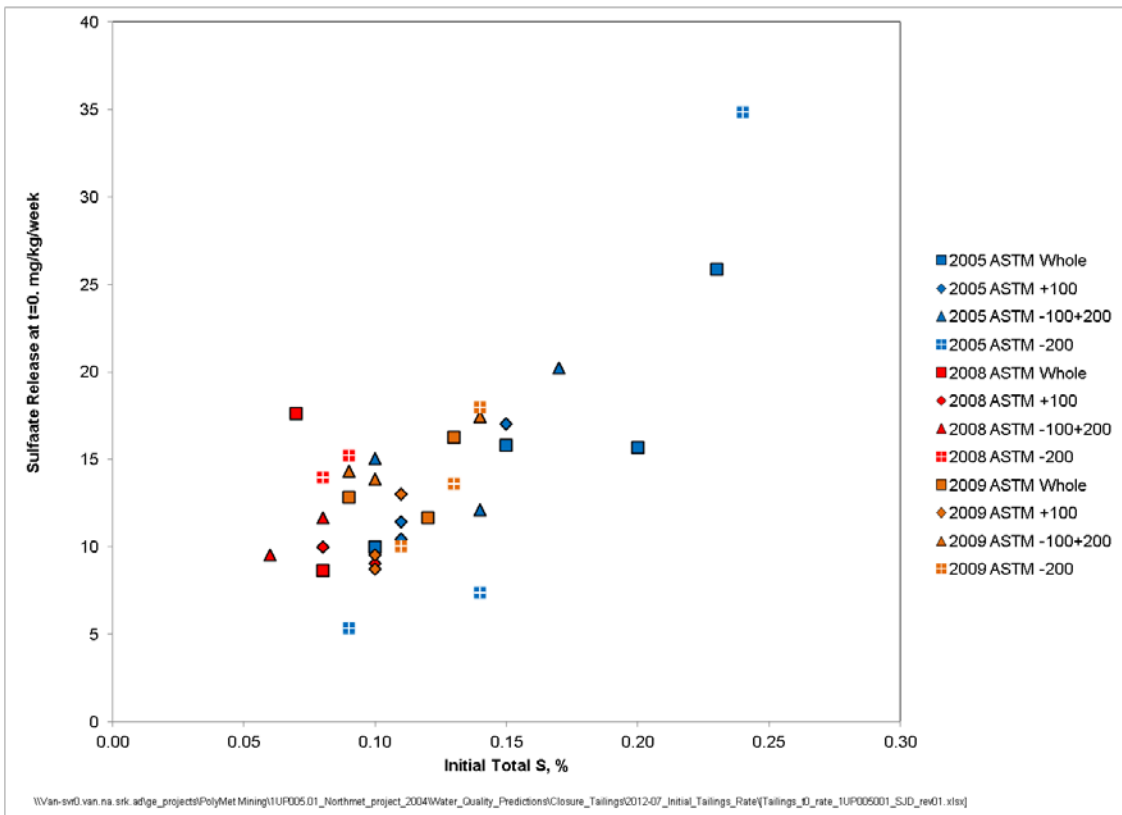
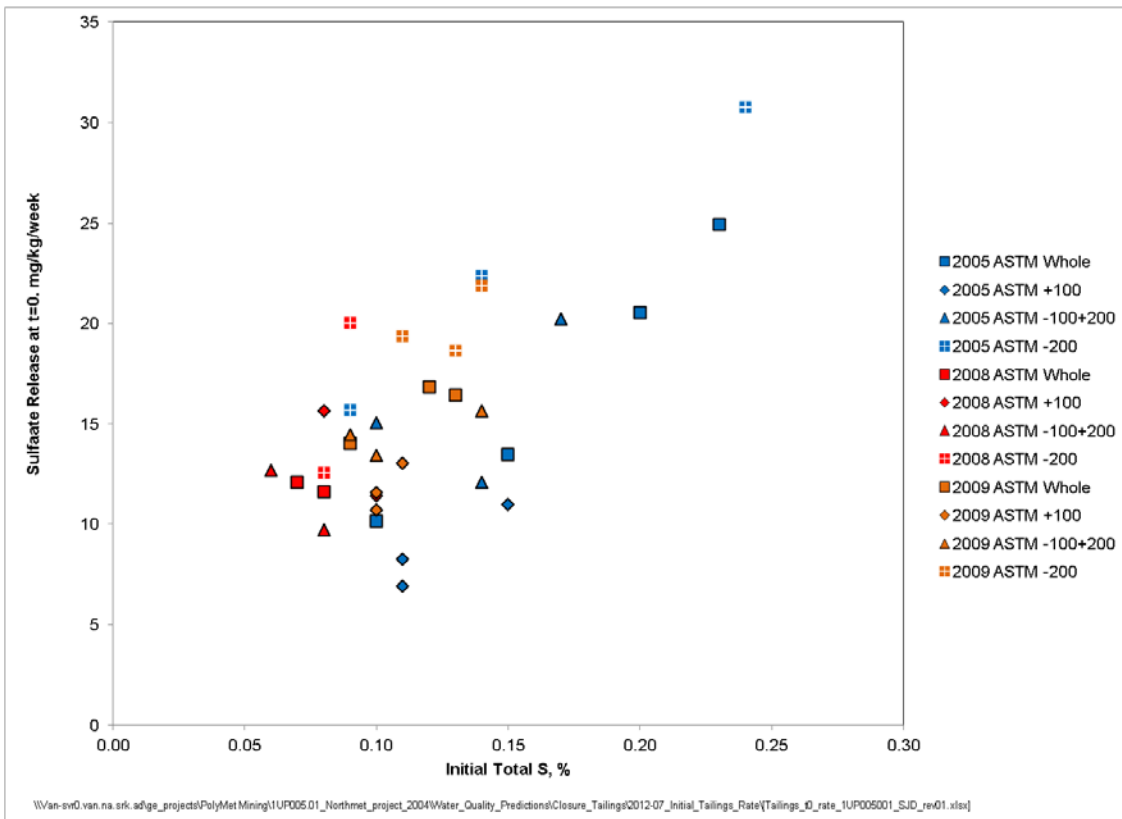

Figure 9. Calculated Initial Sulfate Release as a Function of Initial Total Sulfur Content Using MDNR (top) and SRK (bottom) methods.

## 5 Hydrometallurgical Residue Kinetic Tests

As agreed with MNDR, hydrometallurgical kinetic tests were stopped shortly after reported by SRK (2009).

## 6 Conclusions

Review of data generated by up to nearly eight years of testing indicates that:

- Waste rock classification into three categories using sulfur content to address potential for pH acidification appears to be robust. In particular, samples classified as Category 1 have not shown pH depression below that of the deionized water used to leach the samples.
- Sulfide oxidation and metal leaching trends for waste rock samples show well defined phases as pH depression occurs. These trends have been used to calculate release rates for use in development of source terms. Ongoing testwork has resulted in some additional rate information for later phases.
- Tailings humidity cells have not shown pH depression below that of the deionized water indicating that weathering of silicates provides alkalinity to offset acidity from sulfide oxidation.
- Long term trends in tailings humidity cells show declining oxidation rates which are presumably linked to depletion of the sulfide minerals and indicates that sulfide oxidation is following a non-zero order reaction rate law. However, to be consistent with the simplified modeling approach used in GoldSim®, which assumes a zero order reaction rate law, trends in sulfide oxidation rates have been used to back-calculate reaction rates at the initial sulfur content for use in modeling.
- Other than addressing this recommendation, updating the rates used as inputs to tailings water quality modeling is not recommended.

## 7 References

SRK Consulting. 2009. RS82 - Update on Use of Kinetic Test Data for Water Quality Predictions – DRAFT 02. Memorandum to Kim Lapakko, MDNR. February 7, 2009.

SRK Consulting. 2011. Update on Tailings Humidity Cell Test Data – NorthMet Project – Draft. Memorandum to Peter Hinck, Barr Engineering. December 23, 2011.

### SRK Consulting (Canada) Inc.

Stephen Day, PGeo  
Corporate Consultant (Geochemistry)

#### Disclaimer

SRK Consulting (Canada) Inc. has prepared this document for PolyMet Mining Inc. Any use or decisions by which a third party makes of this document are the responsibility of such third parties. In no circumstance does SRK accept any consequential liability arising from commercial decisions or actions resulting from the use of this report by a third party.

The opinions expressed in this report have been based on the information available to SRK at the time of preparation. SRK has exercised all due care in reviewing information supplied by others for use on this project. Whilst SRK has compared key supplied data with expected values, the accuracy of the results and conclusions from the review are entirely reliant on the accuracy and completeness of the supplied data. SRK does not accept responsibility for any errors or omissions in the supplied information, except to the extent that SRK was hired to verify the data.

**Attachment A: Graphs**

---

# P1S

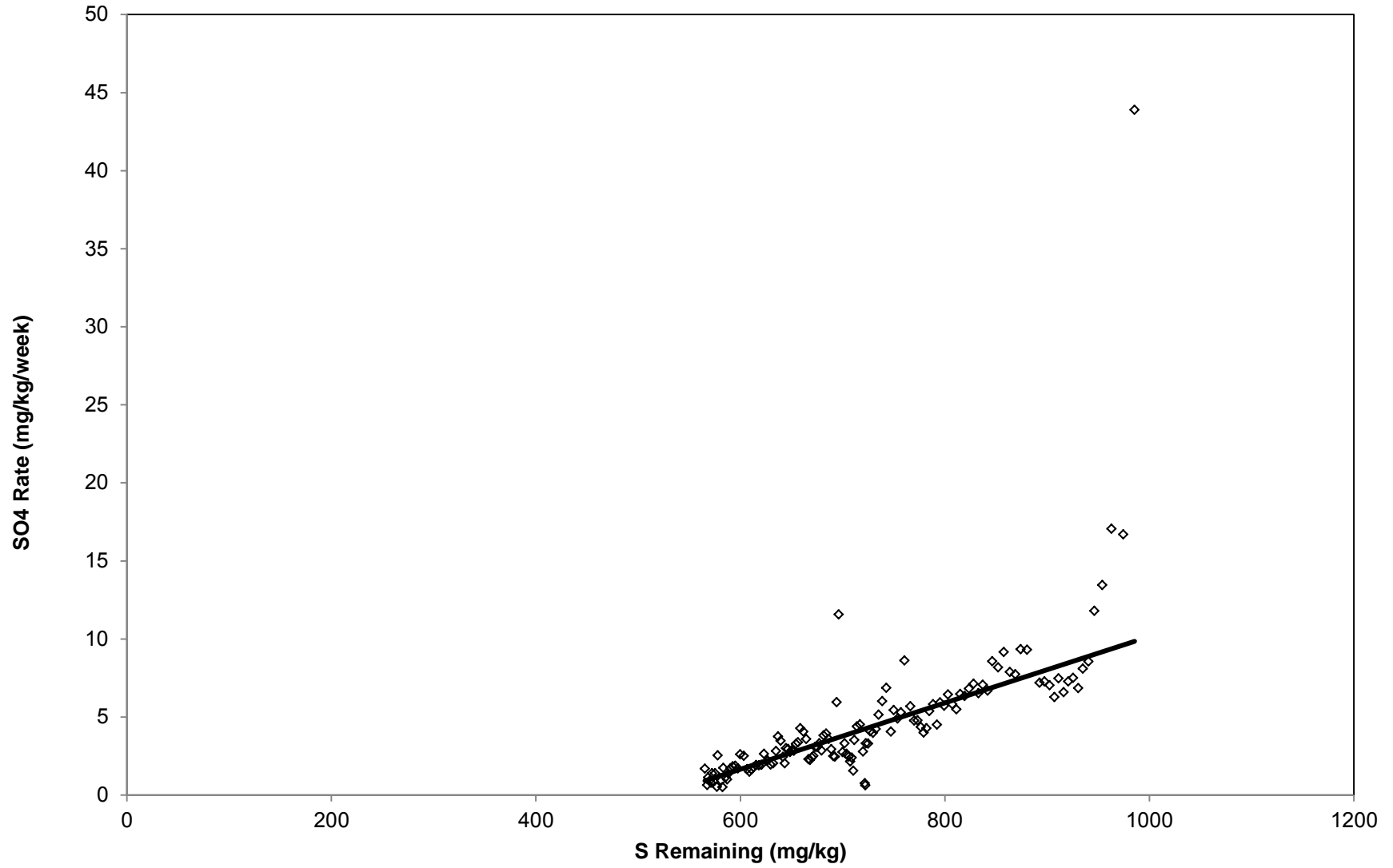

# P1 Solids

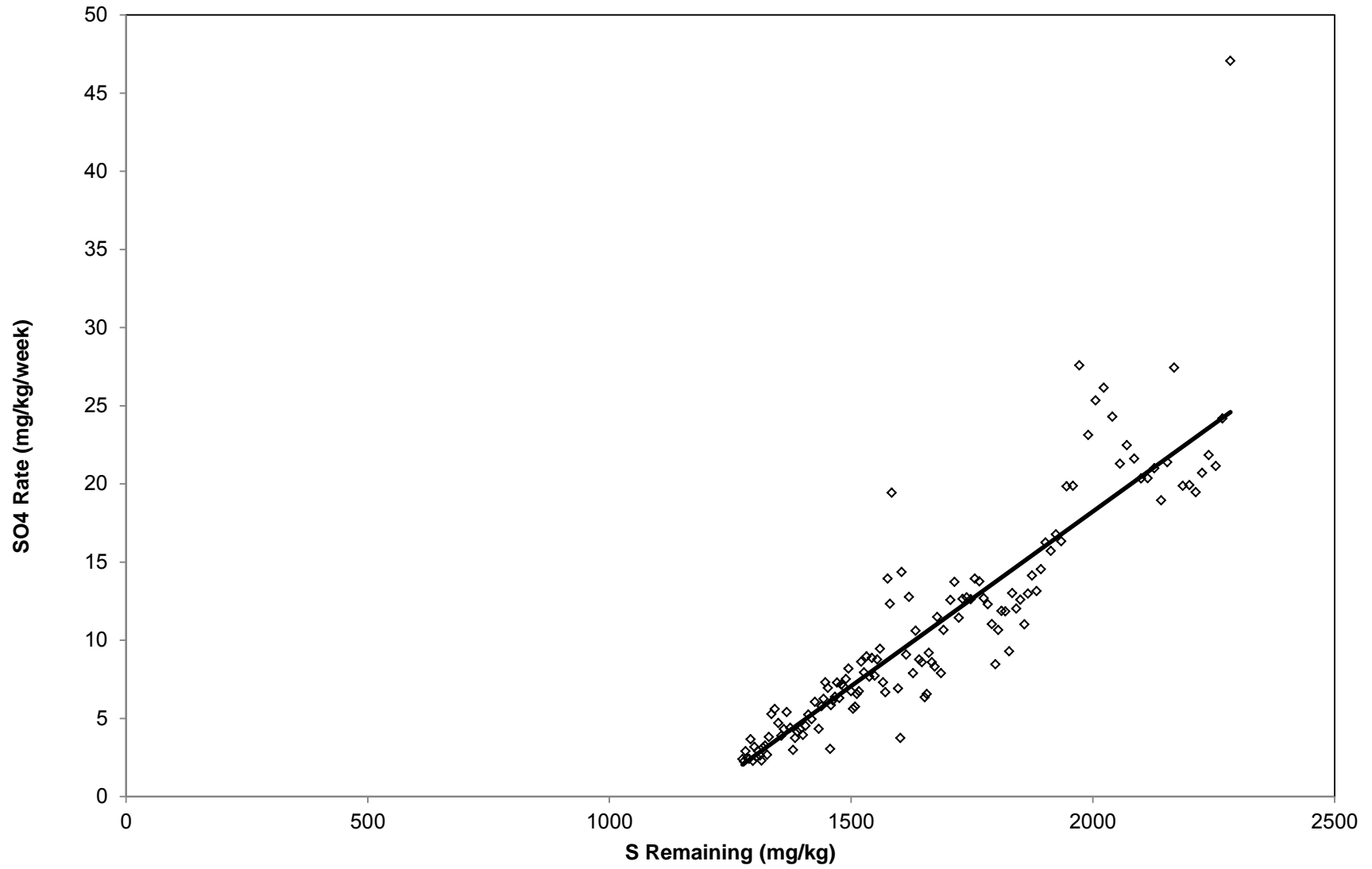



# P2S

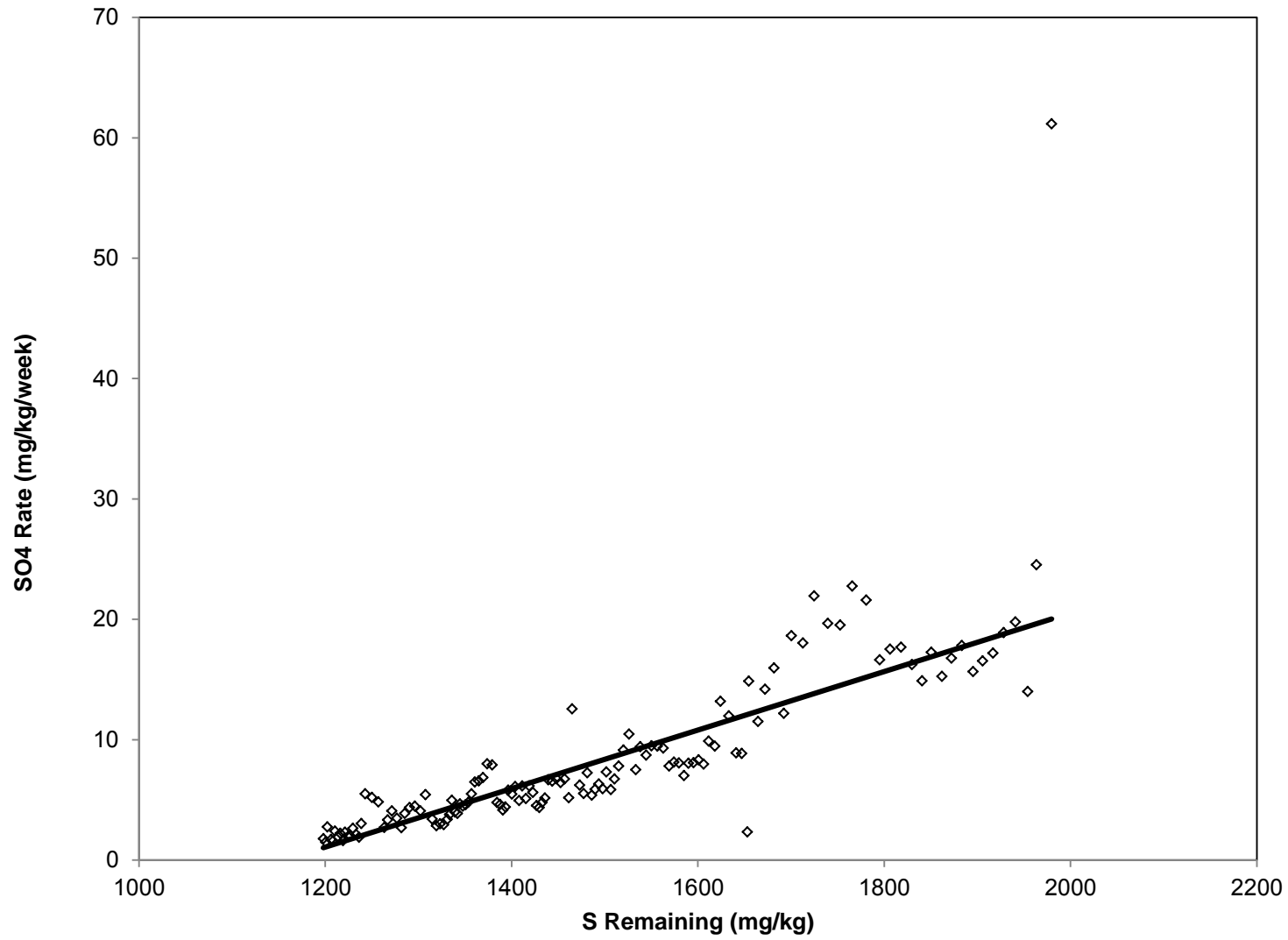

# P3

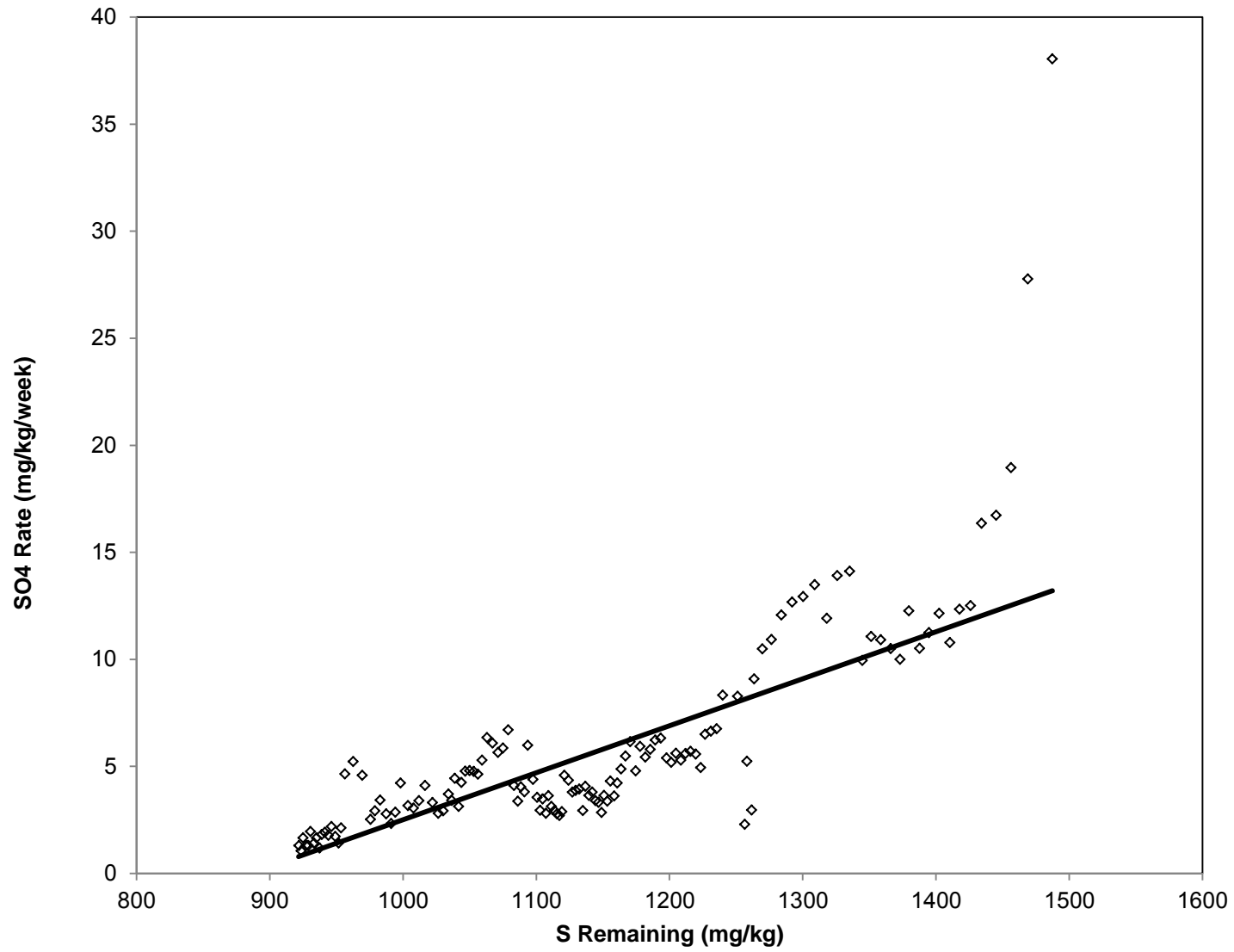

# PA2P2S\_100

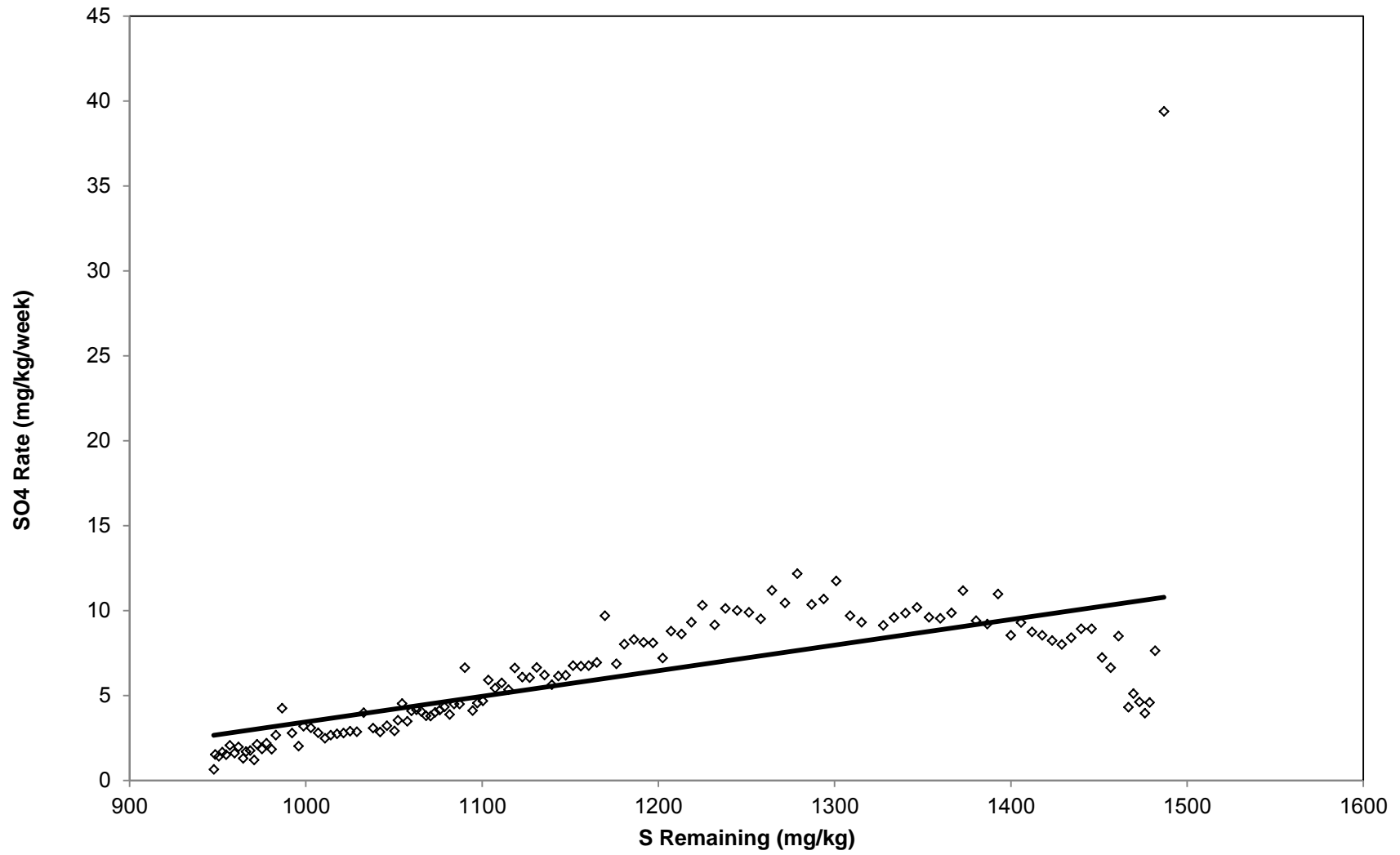

# PA2P2S\_200

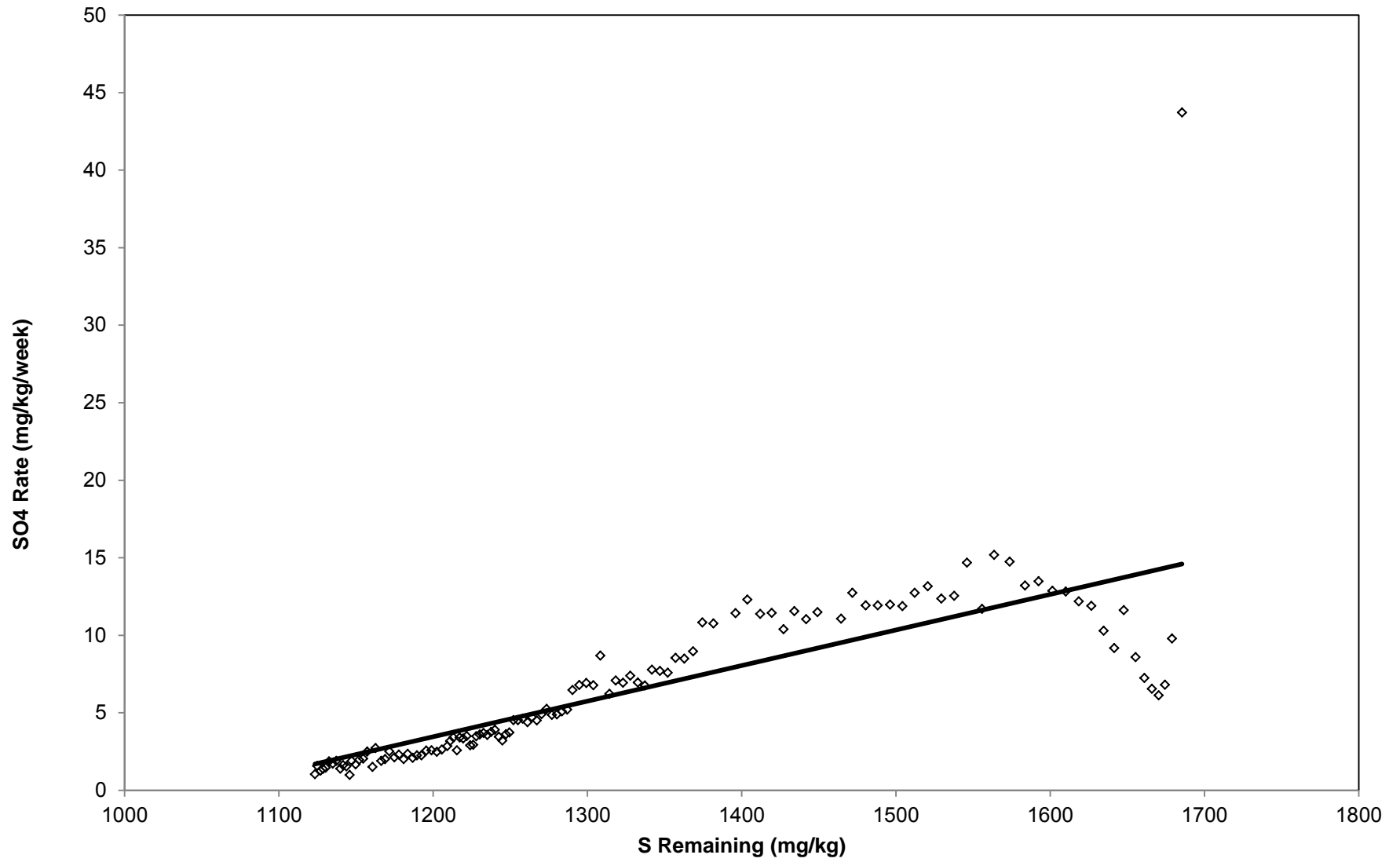

# PA2P2S\_\_200

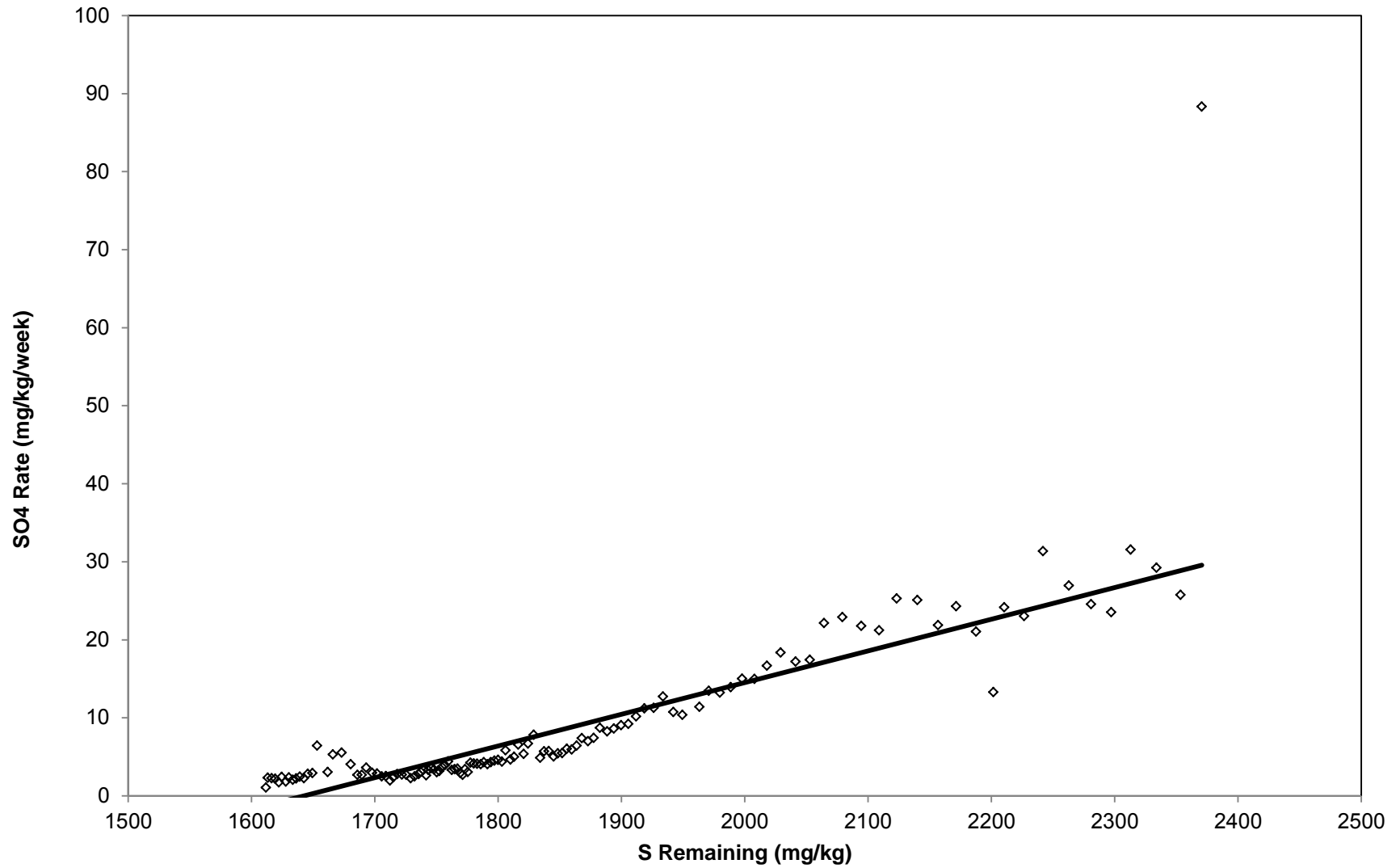

# PA1\_2PISCS\_100

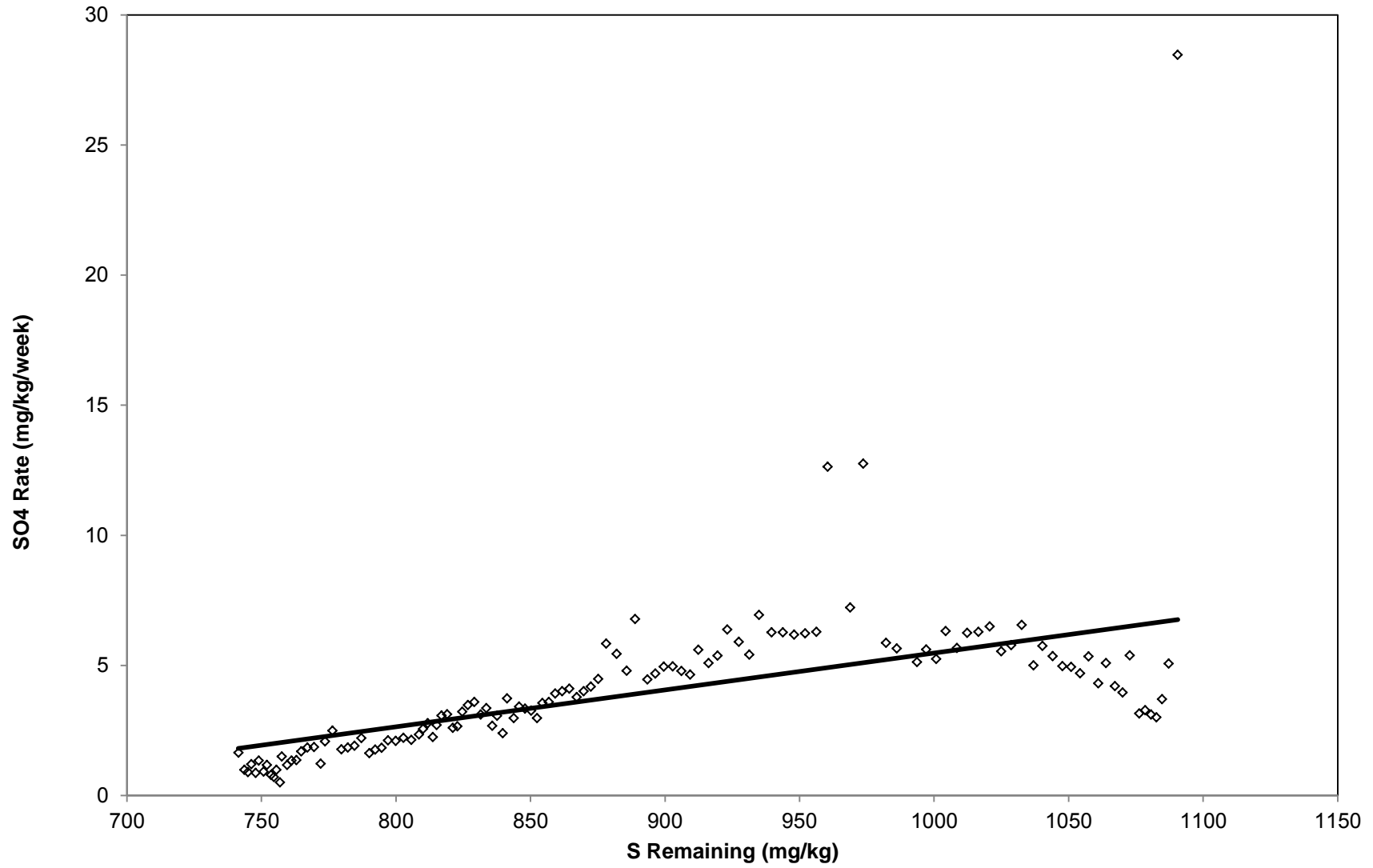

# PA1\_2PISCS\_\_100\_200

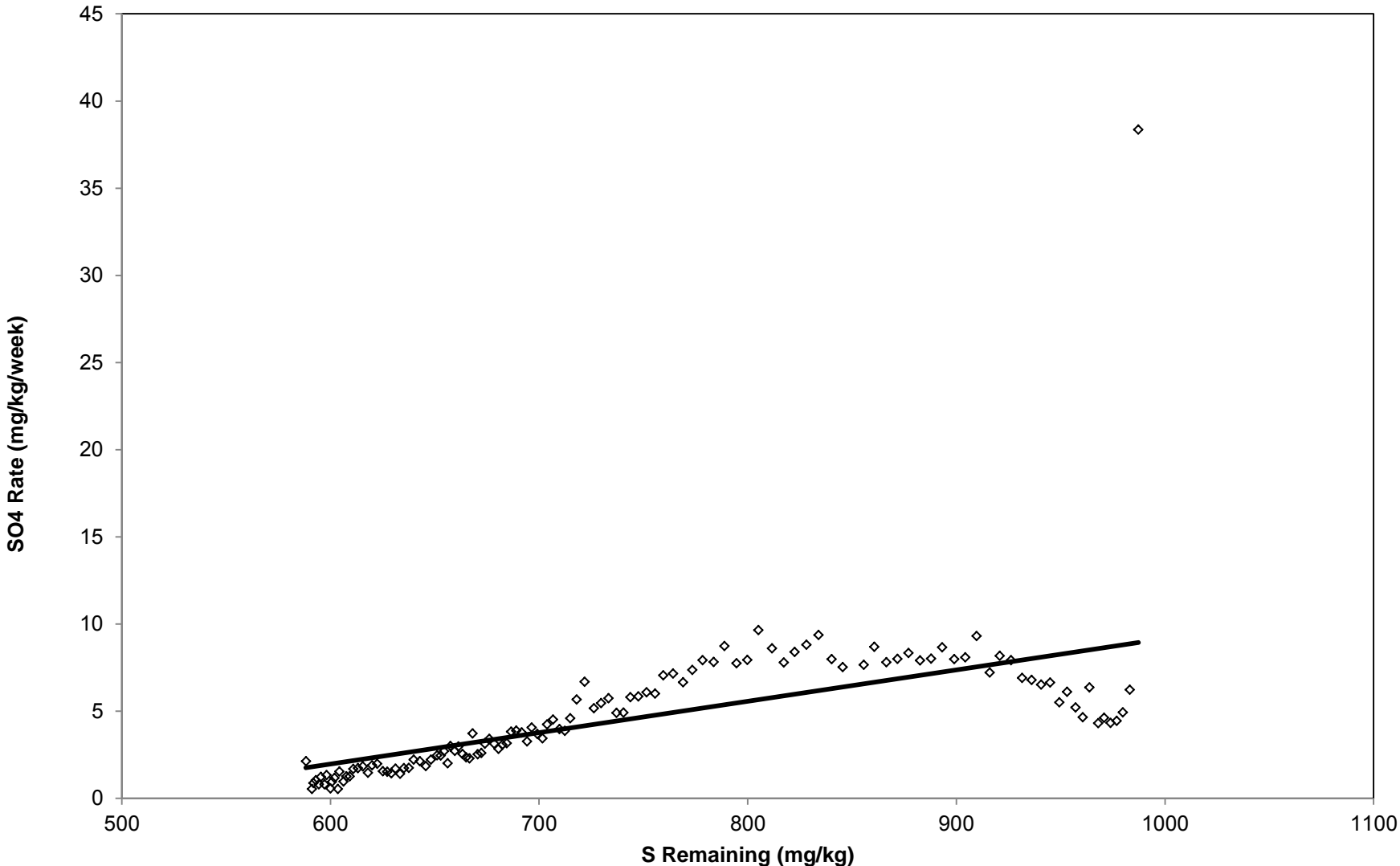

G:\PolyMet Mining\1UP005.01\_Northmet\_project\_2004\Water\_Quality\_Predictions\Closure\_Tailings\2012-07\_Initial\_Tailings\_Rate\[Tailings\_t0\_rate\_1UP005001\_SJD\_rev01.xlsx]

# PA1\_2PISCS\_\_200

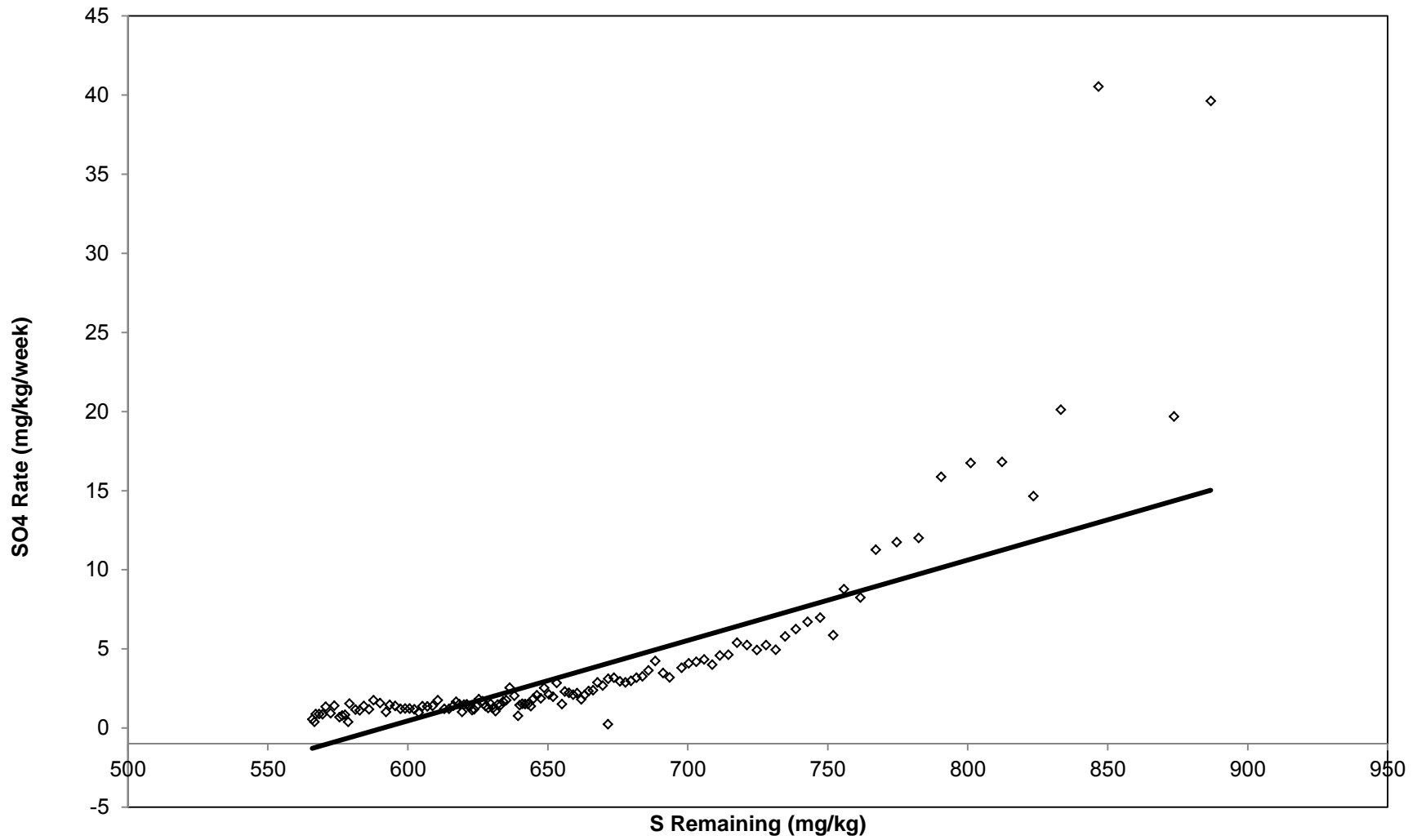



# PA3P3S\_100

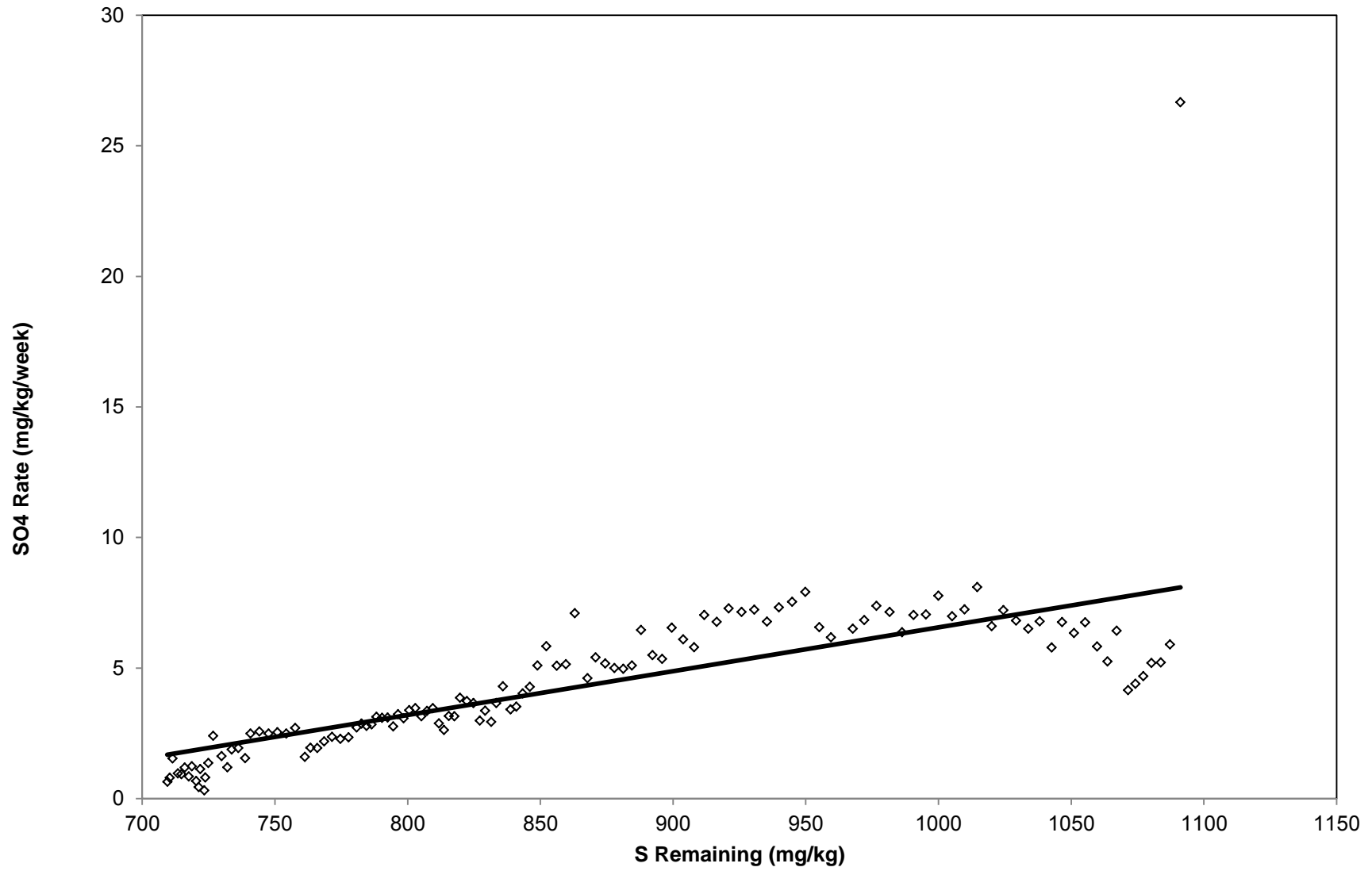

# PA3P3S\_\_100\_200

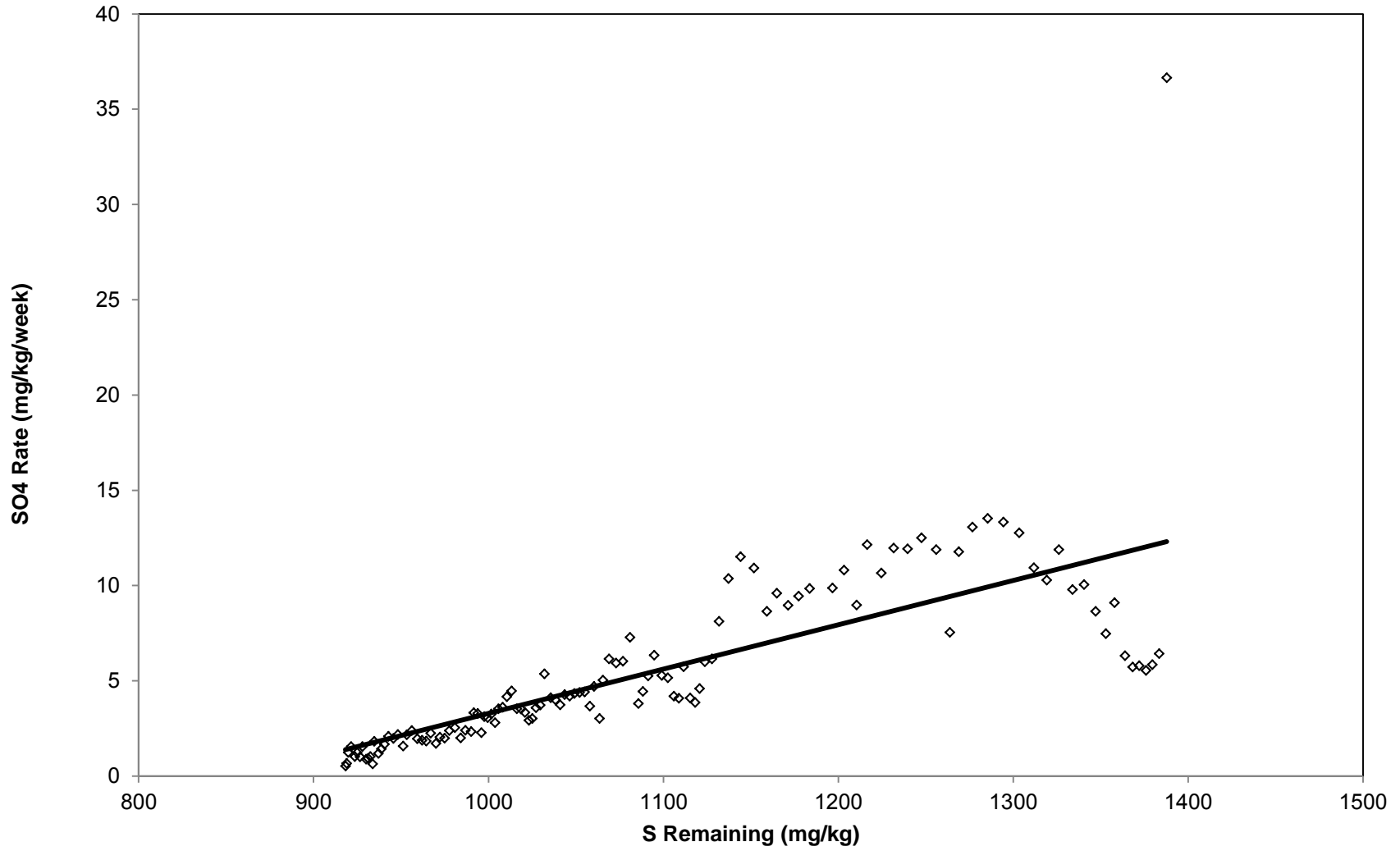

# PA3P3S\_\_200

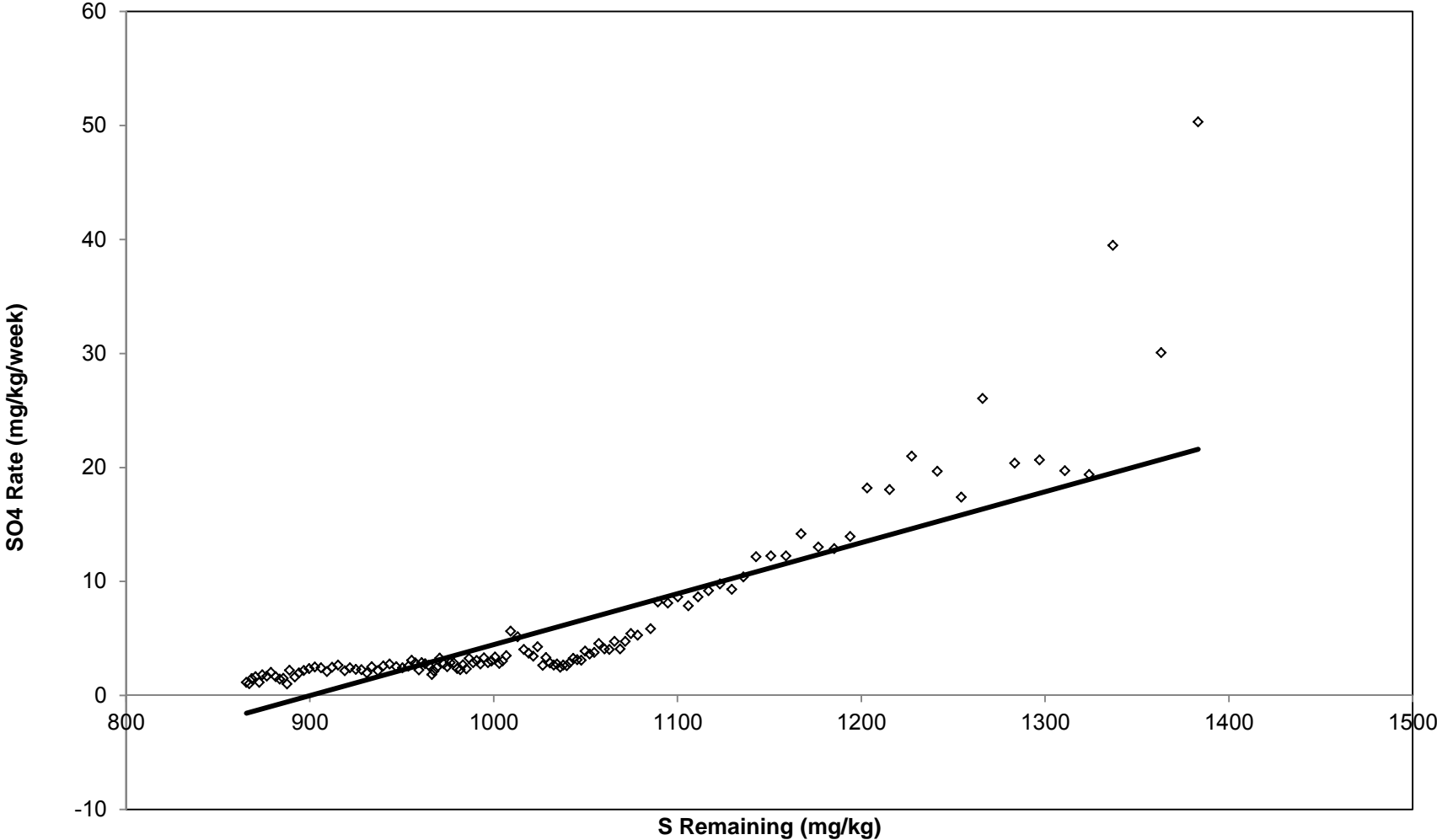

# PP2\_Bulk

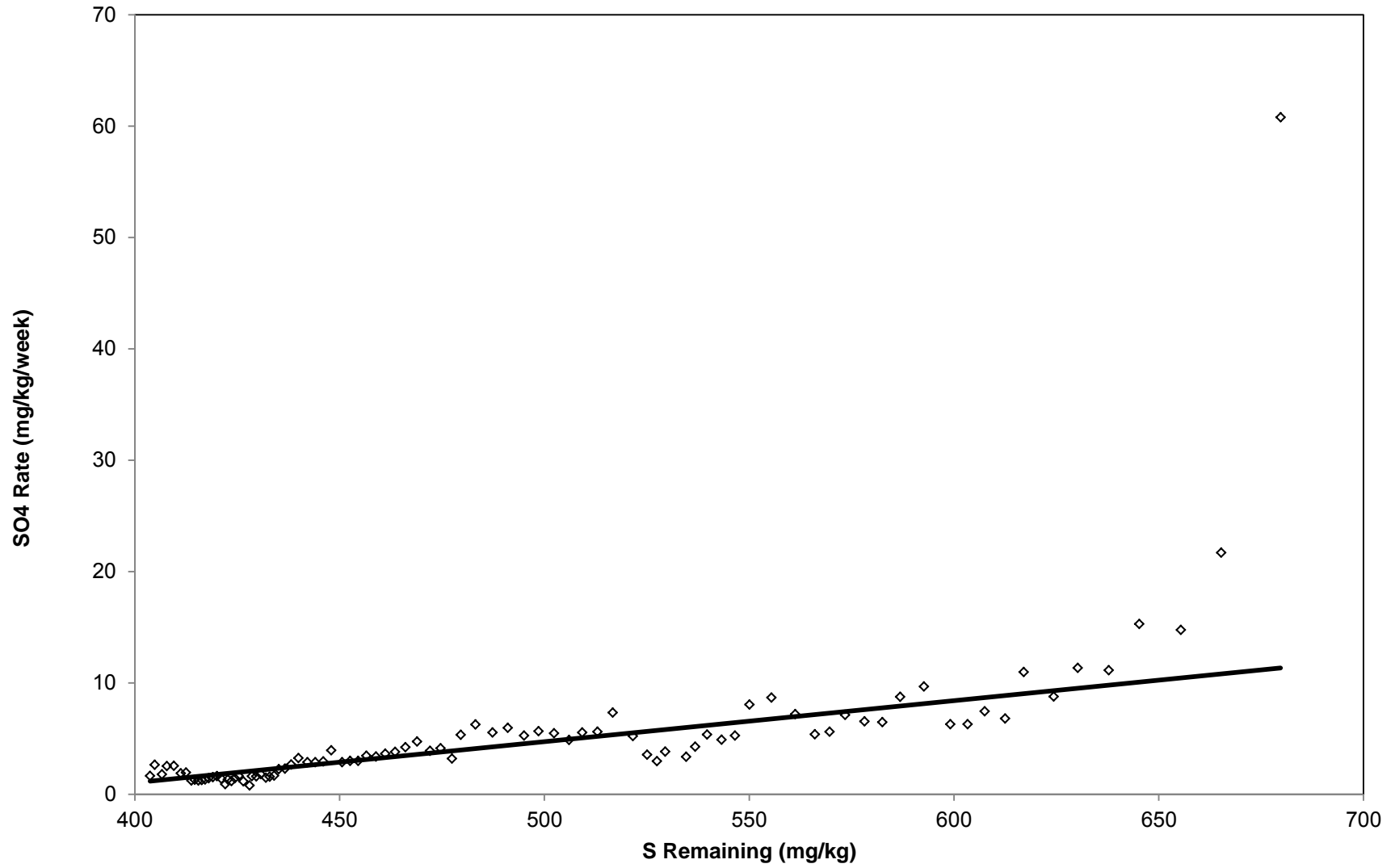

# PP2\_100

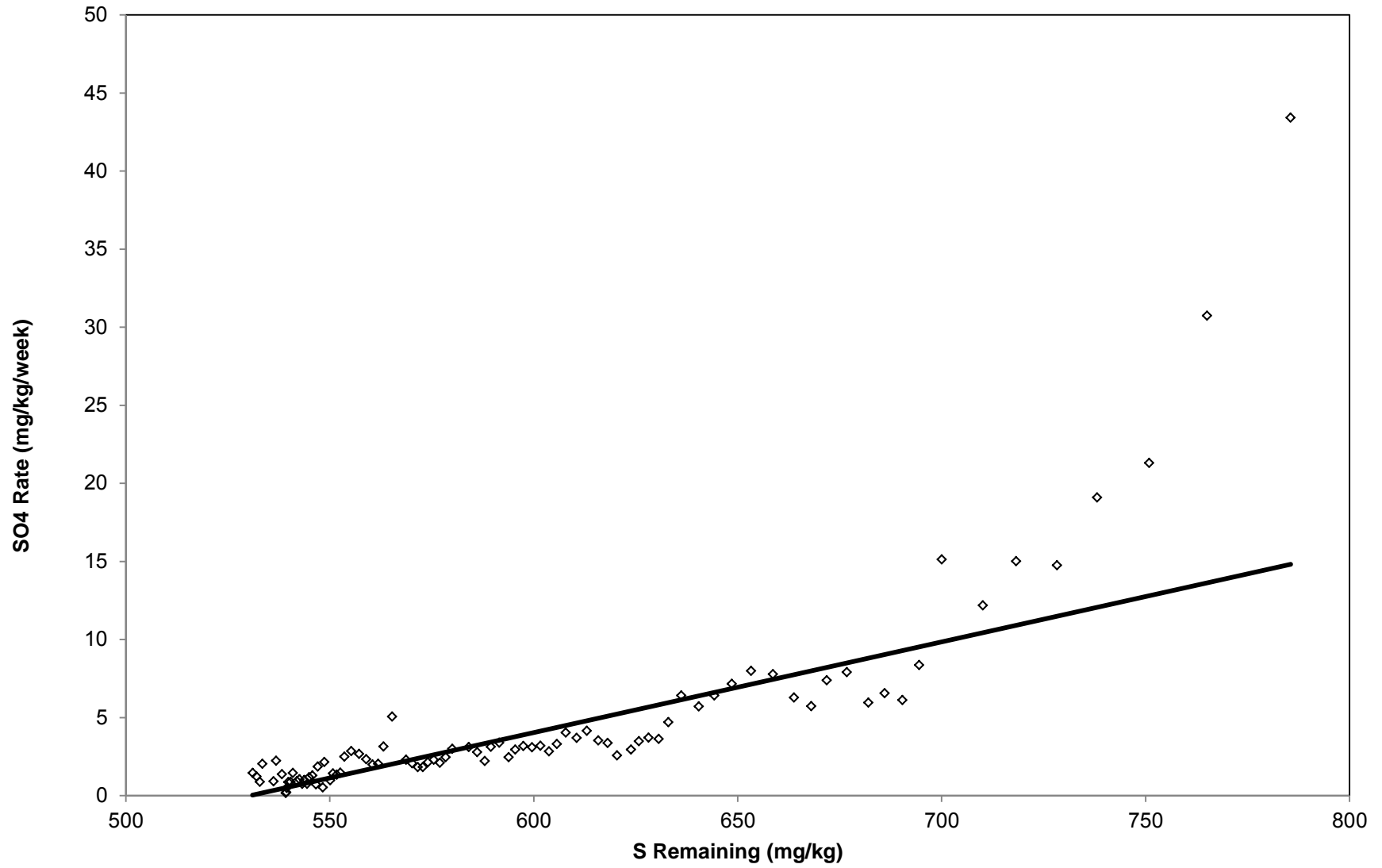

# PP2\_100\_200

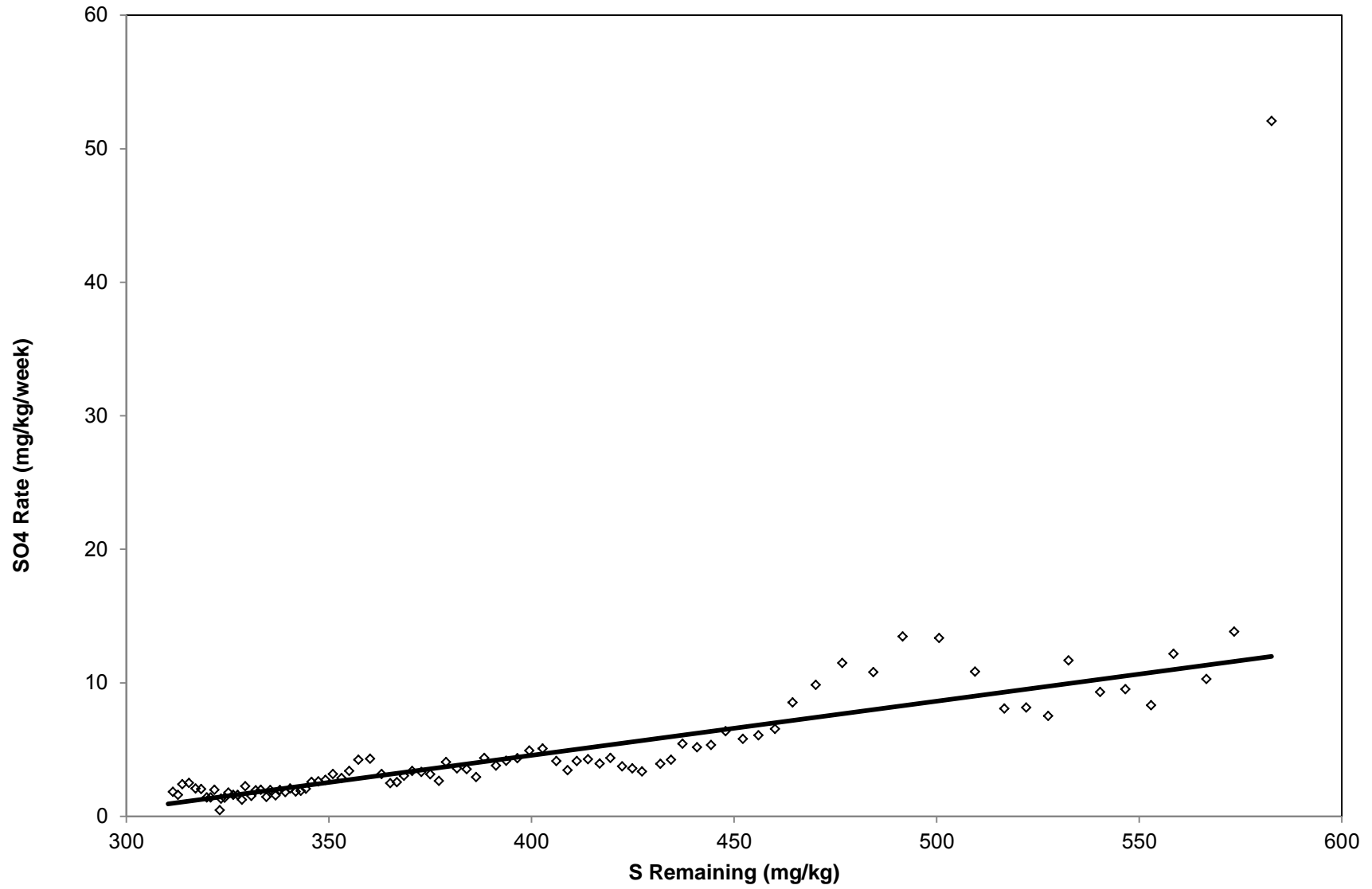

# PP2\_200

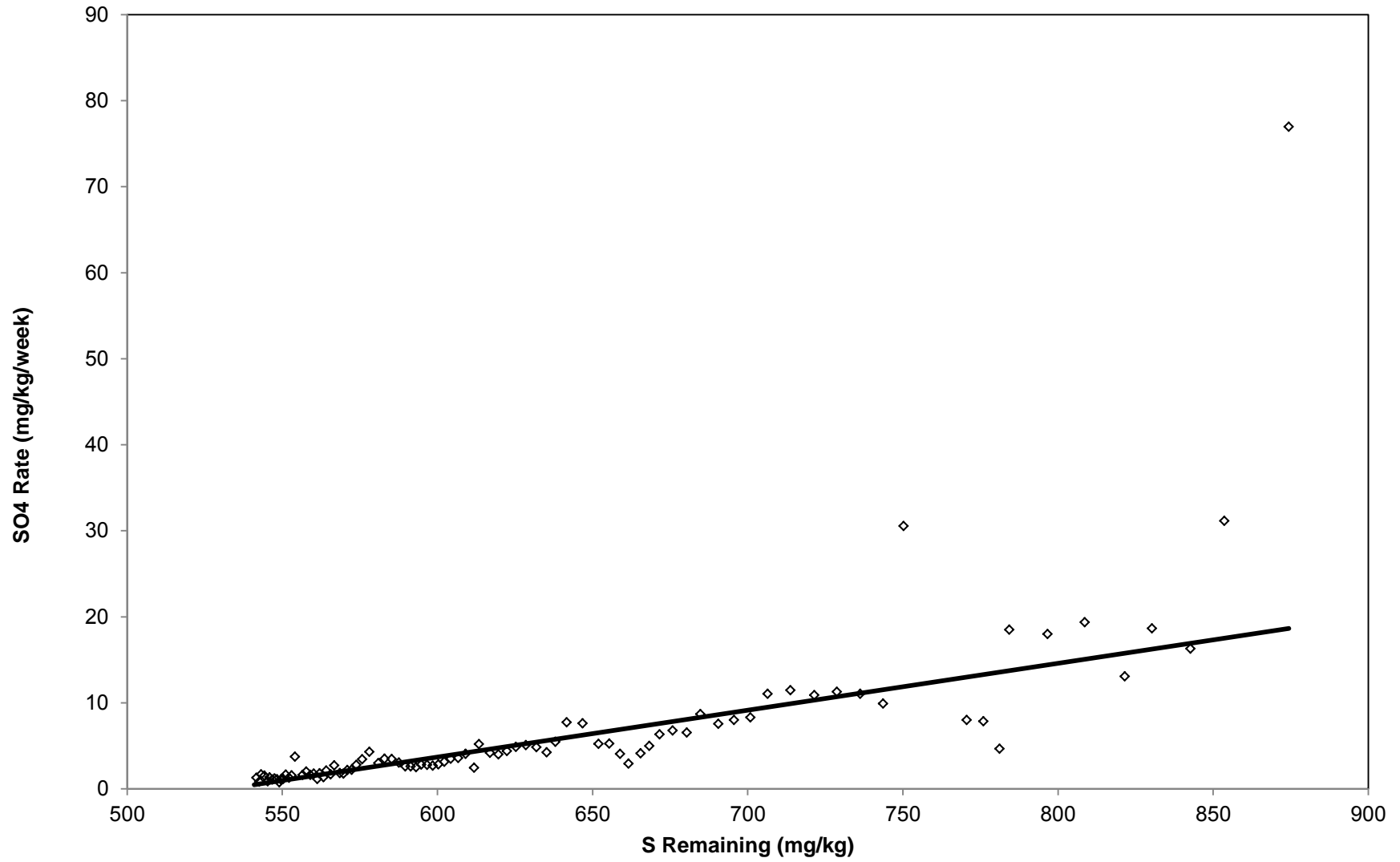

# PP3\_Bulk

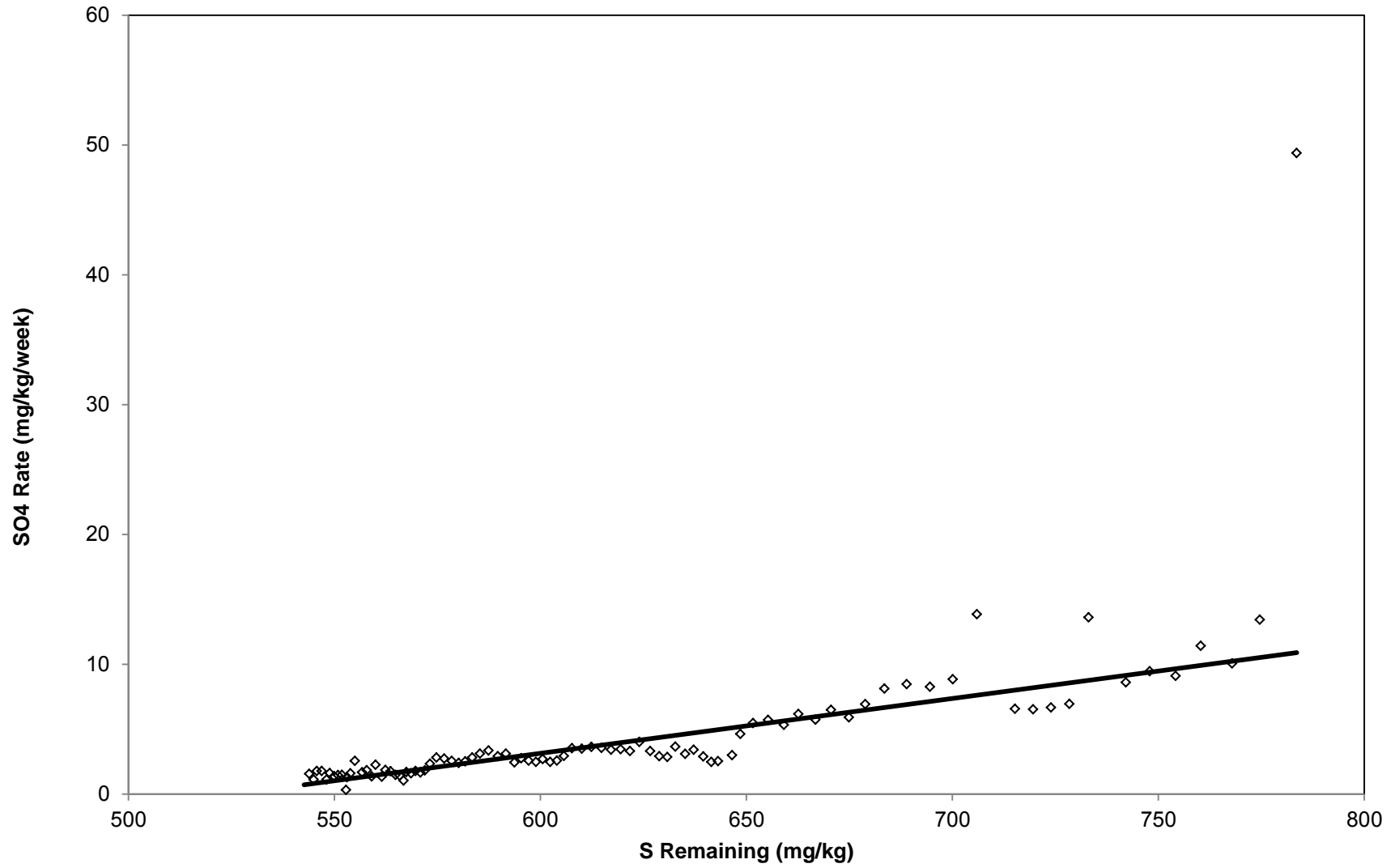



# PP3\_100

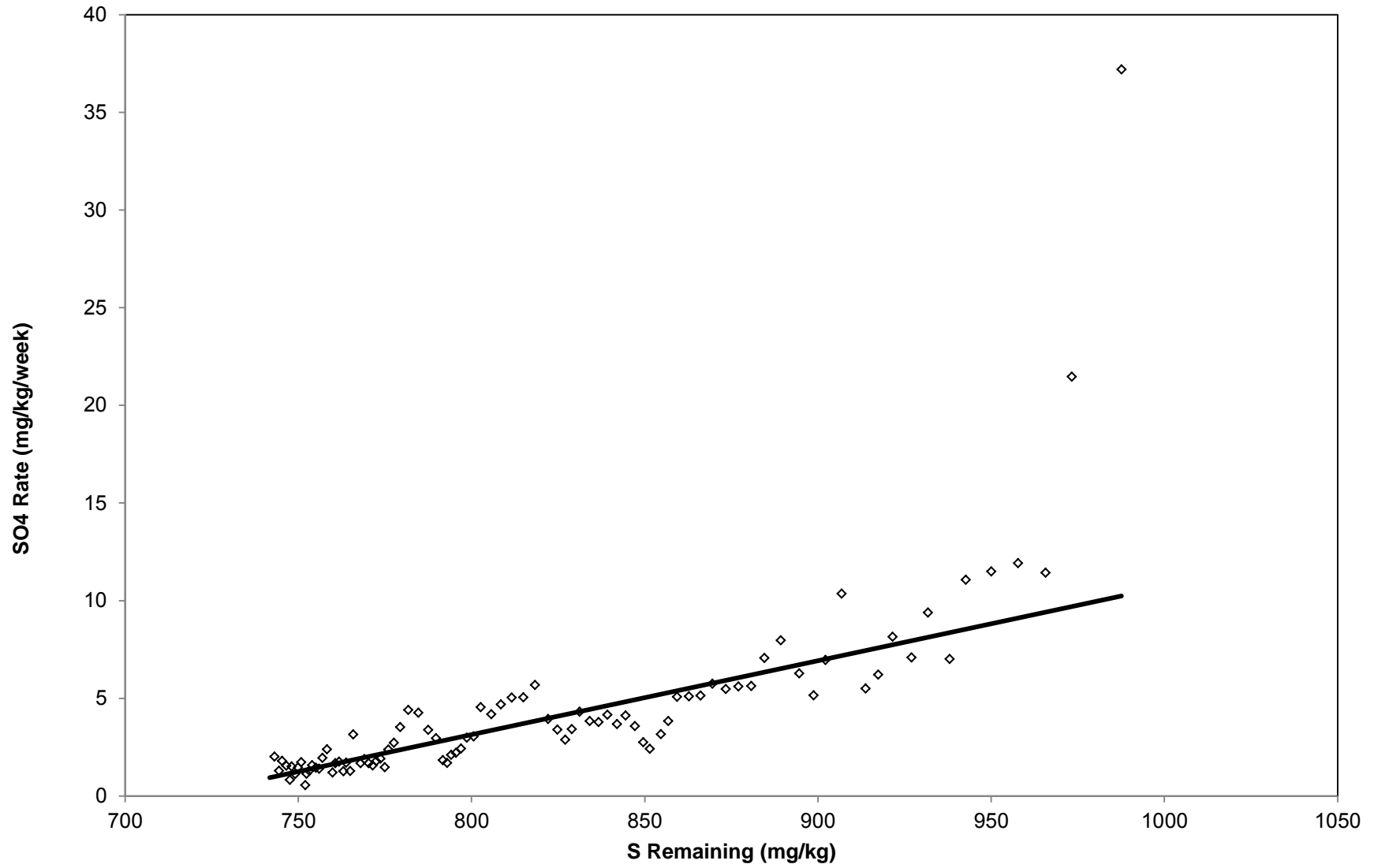

# PP3\_100\_200

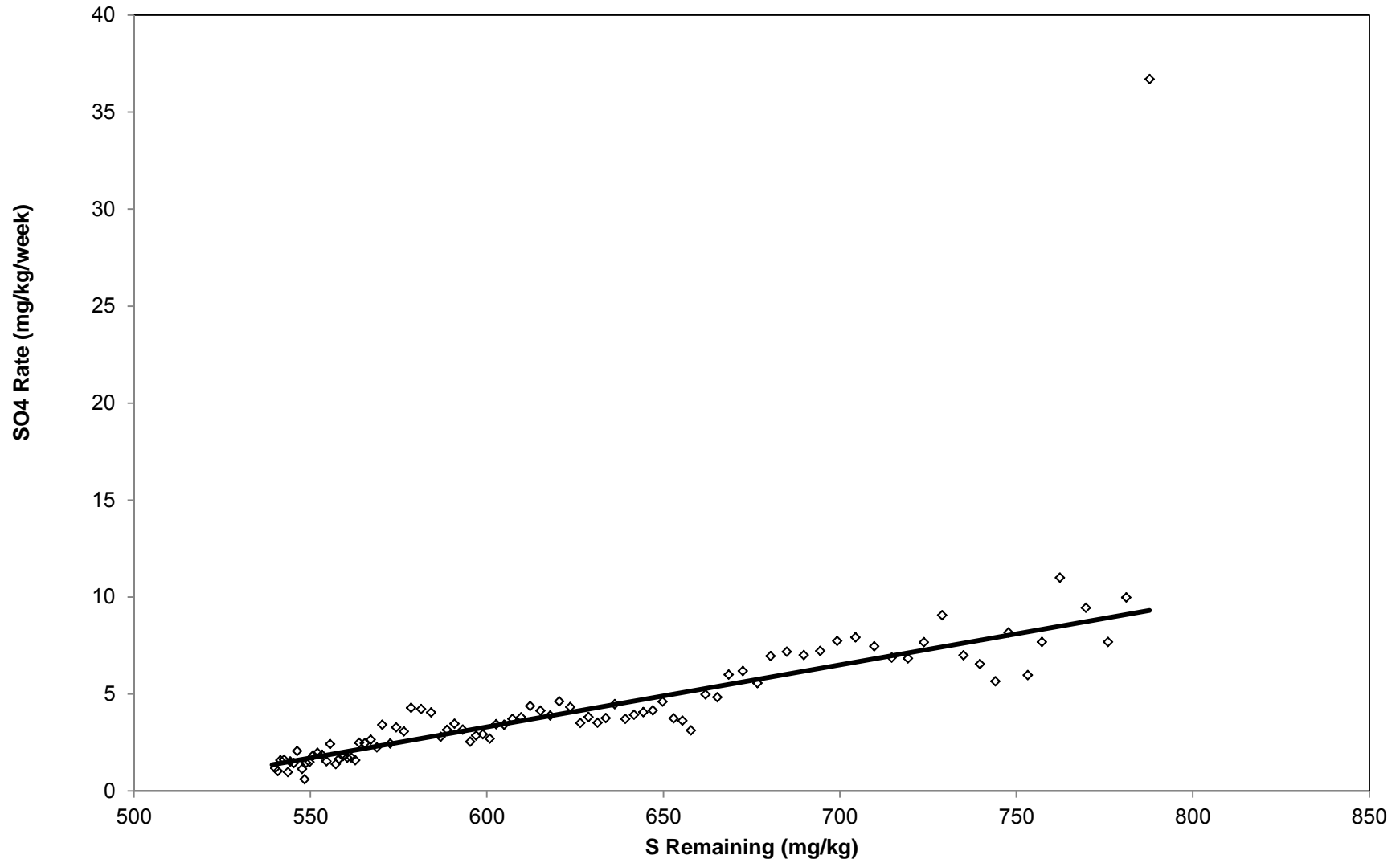

# PP3\_200

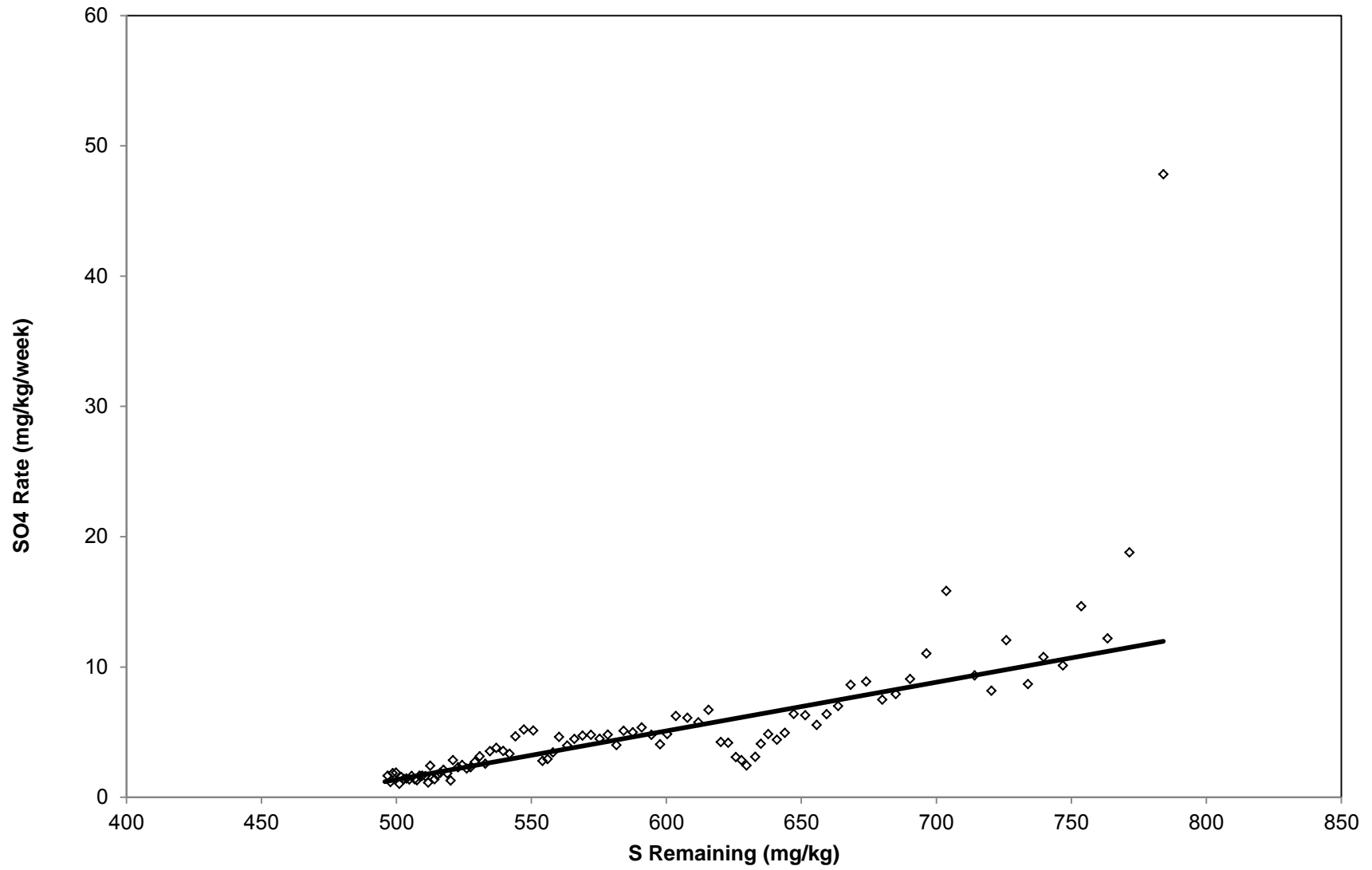

# ST\_Sept30\_bulk

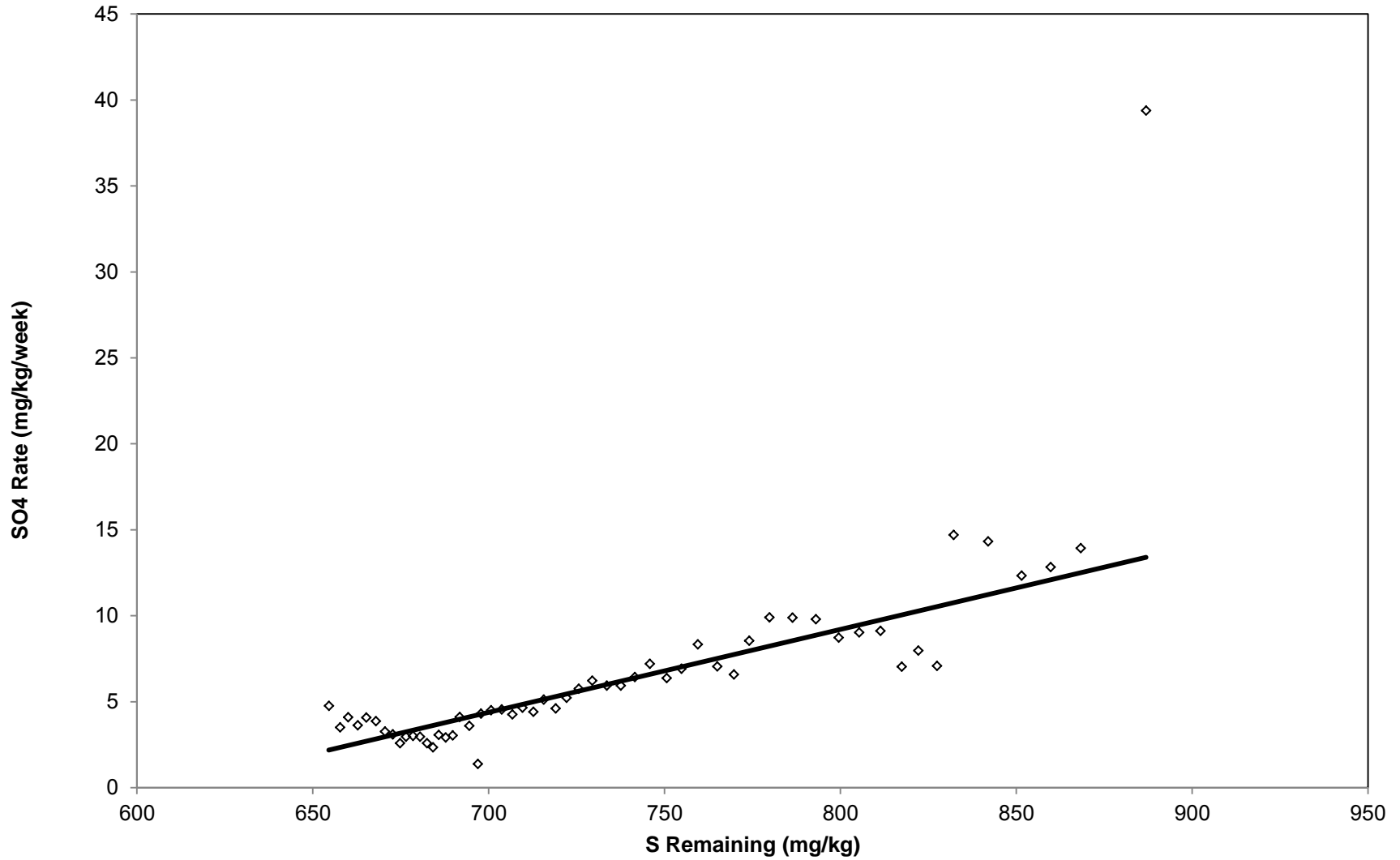

# ST\_Sept30\_100

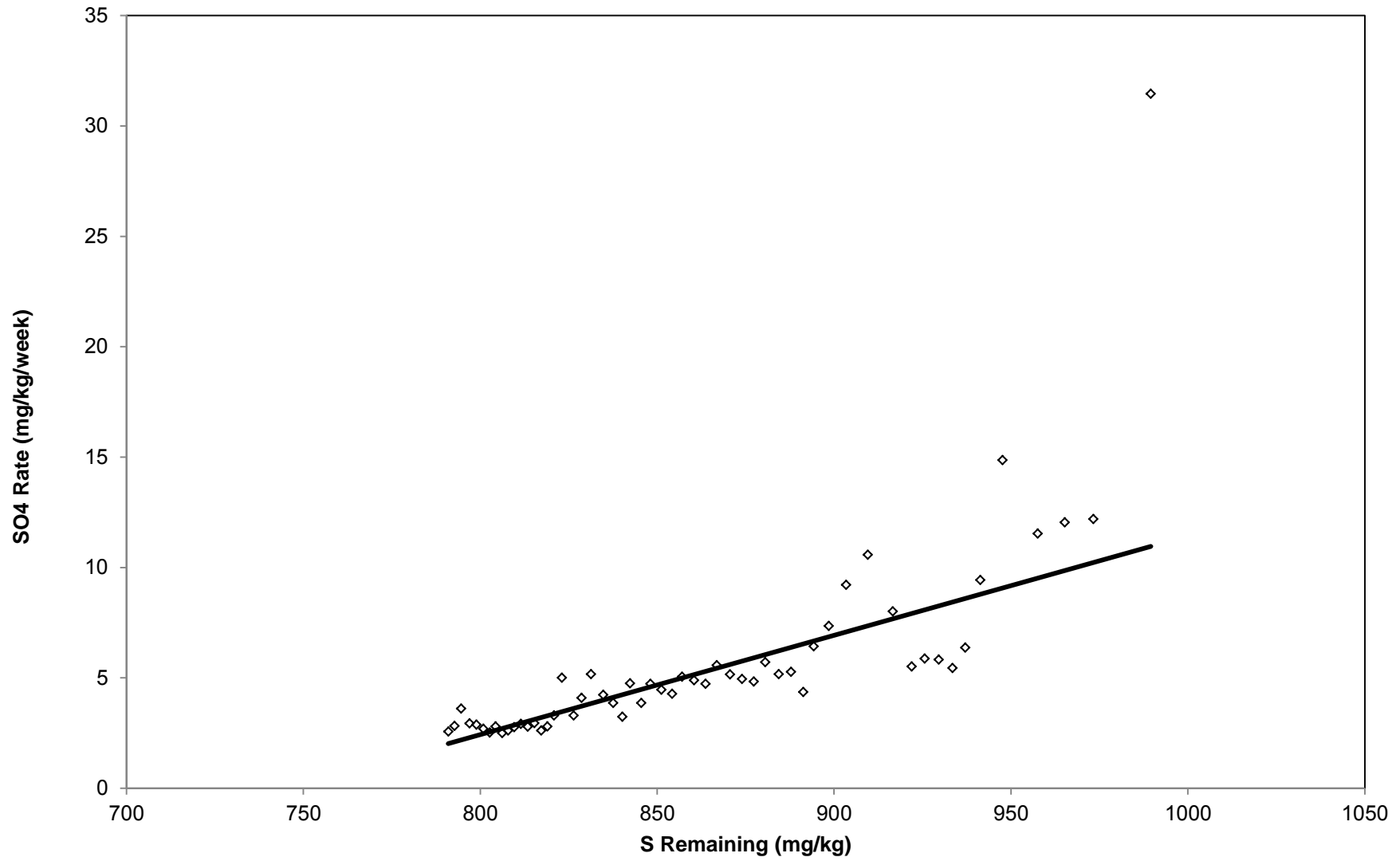

# ST\_Sept30\_100\_200

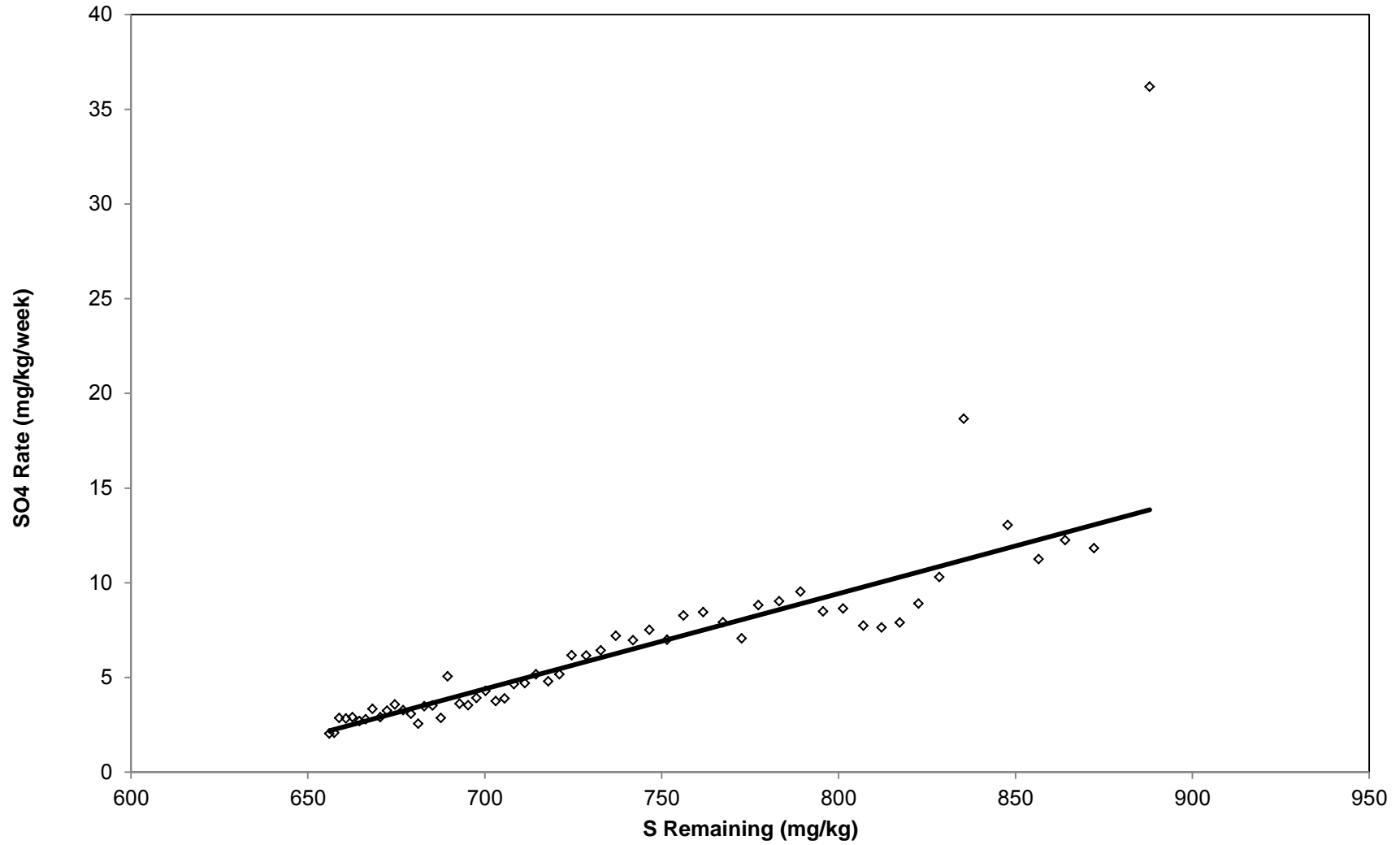

# ST\_Sept30\_200

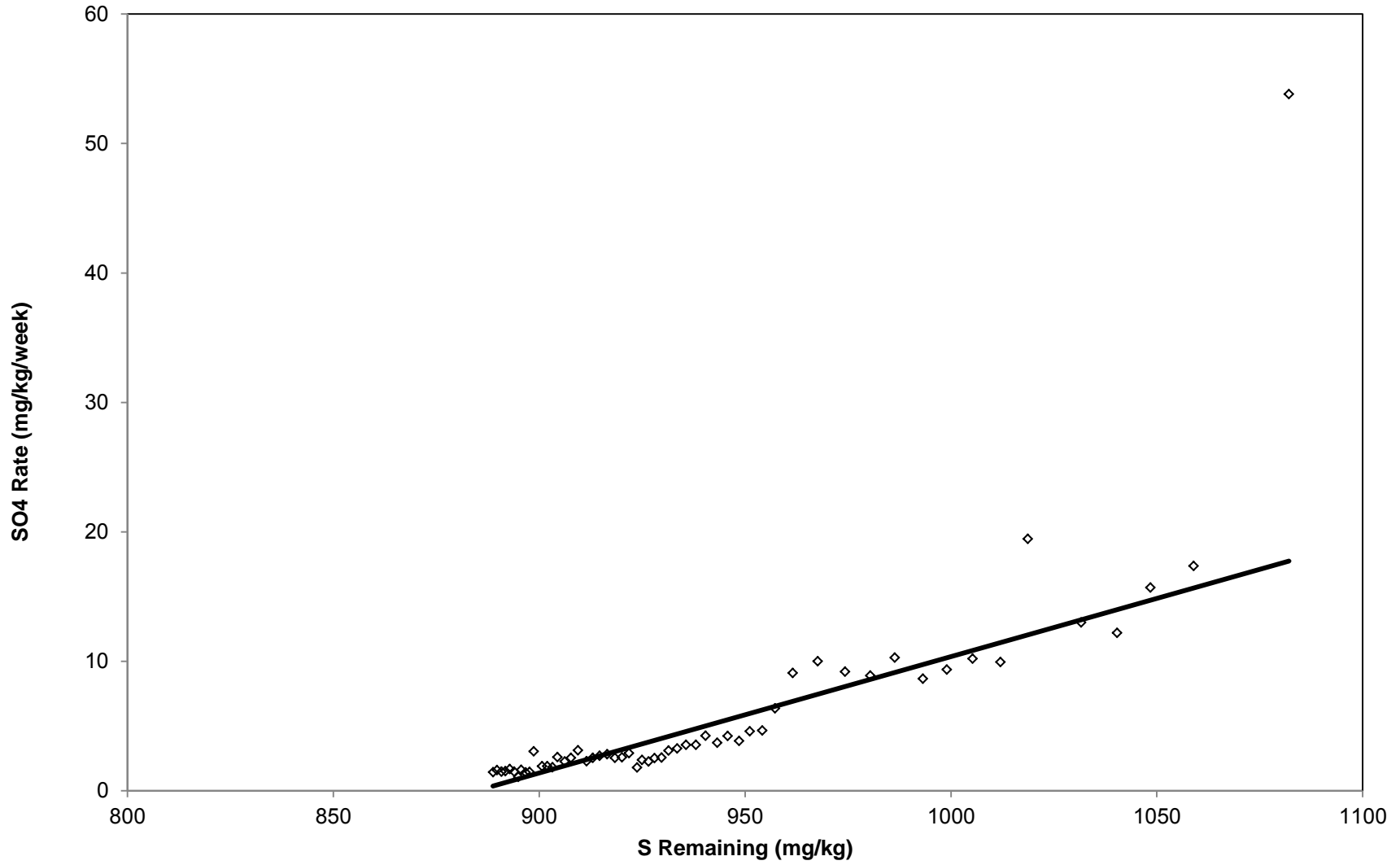

# ST\_Oct1\_9am\_bulk

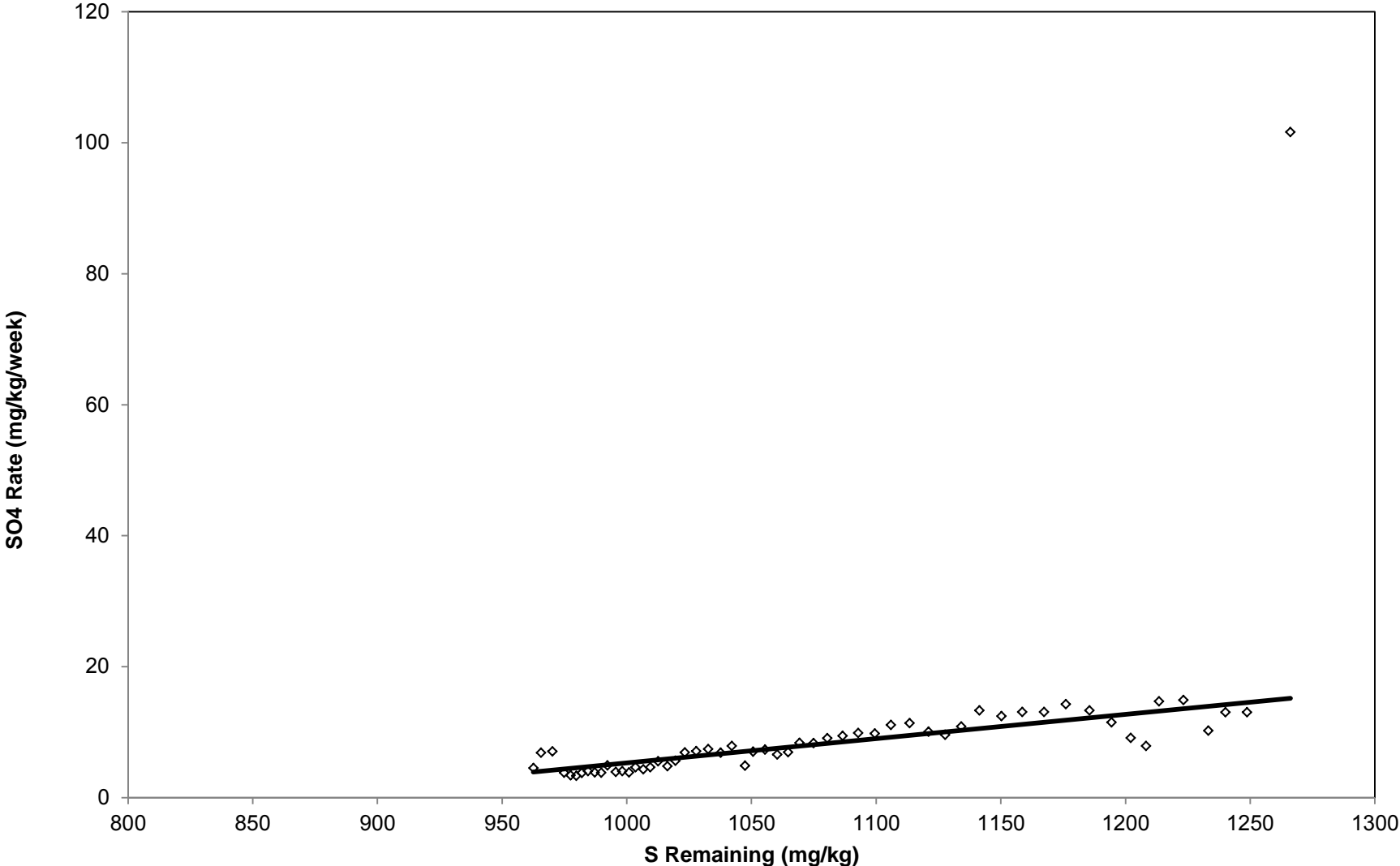



# ST\_Oct1\_9am\_100

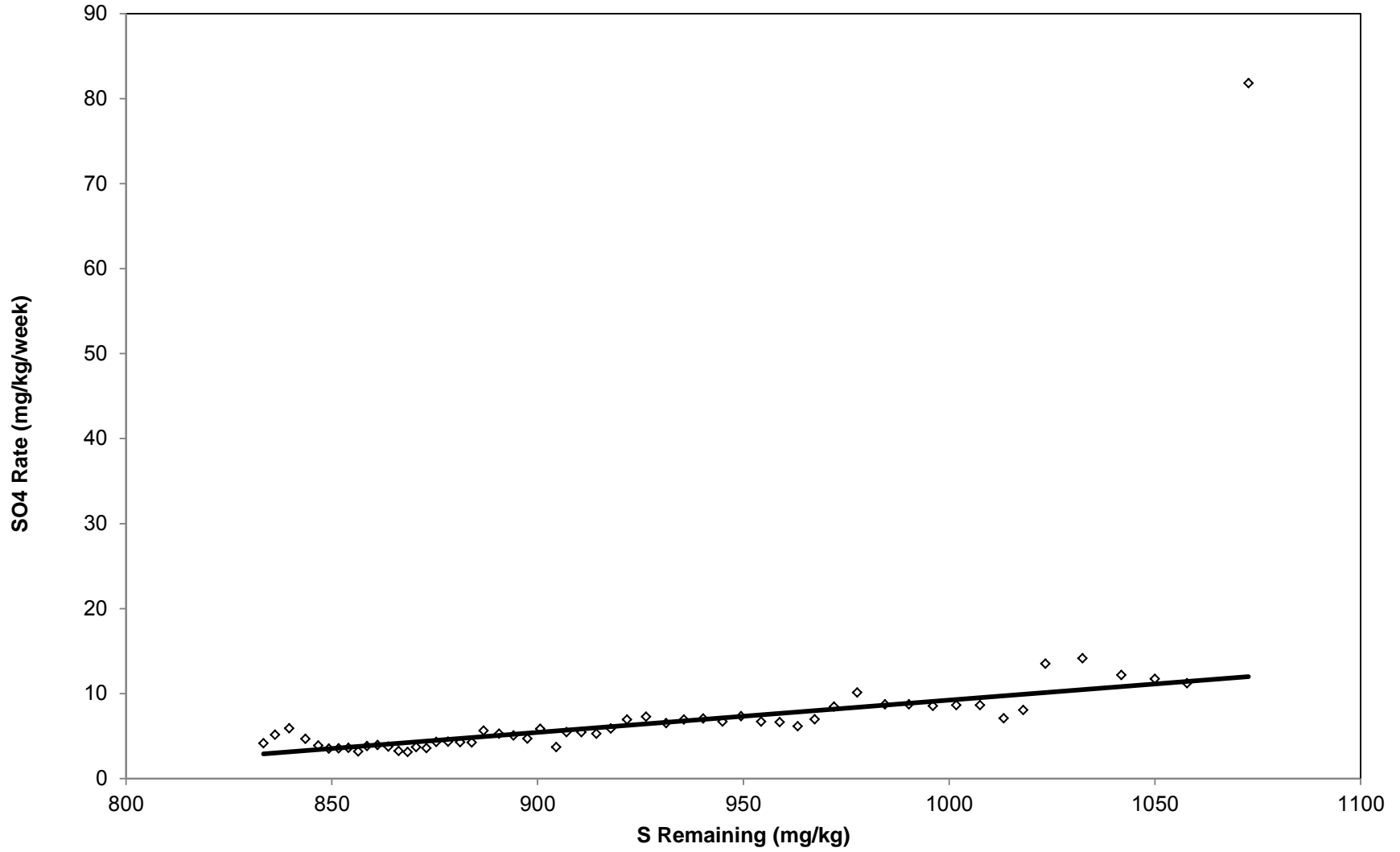

# ST\_Oct1\_9am\_100\_200

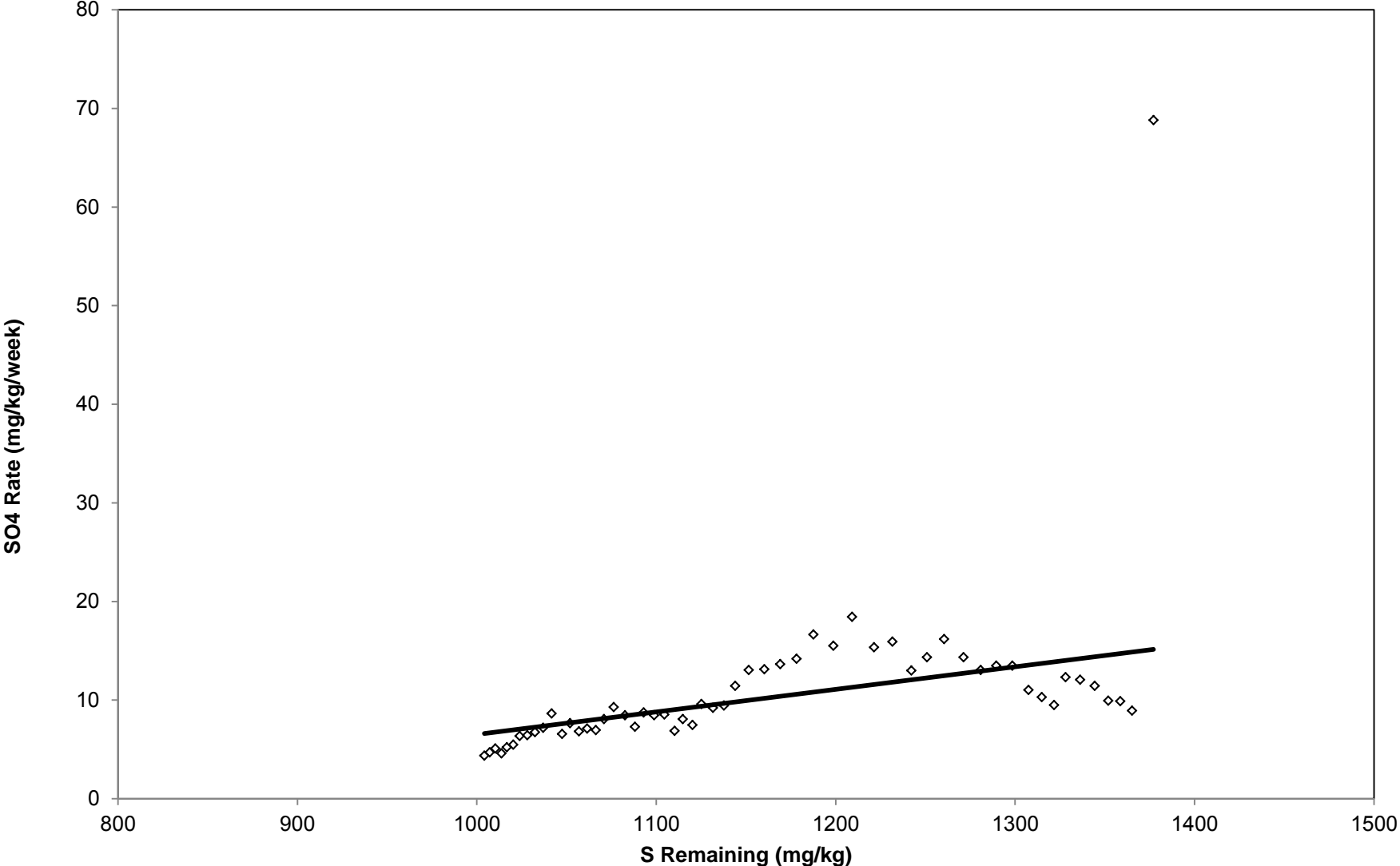

# ST\_Oct1\_9am\_200

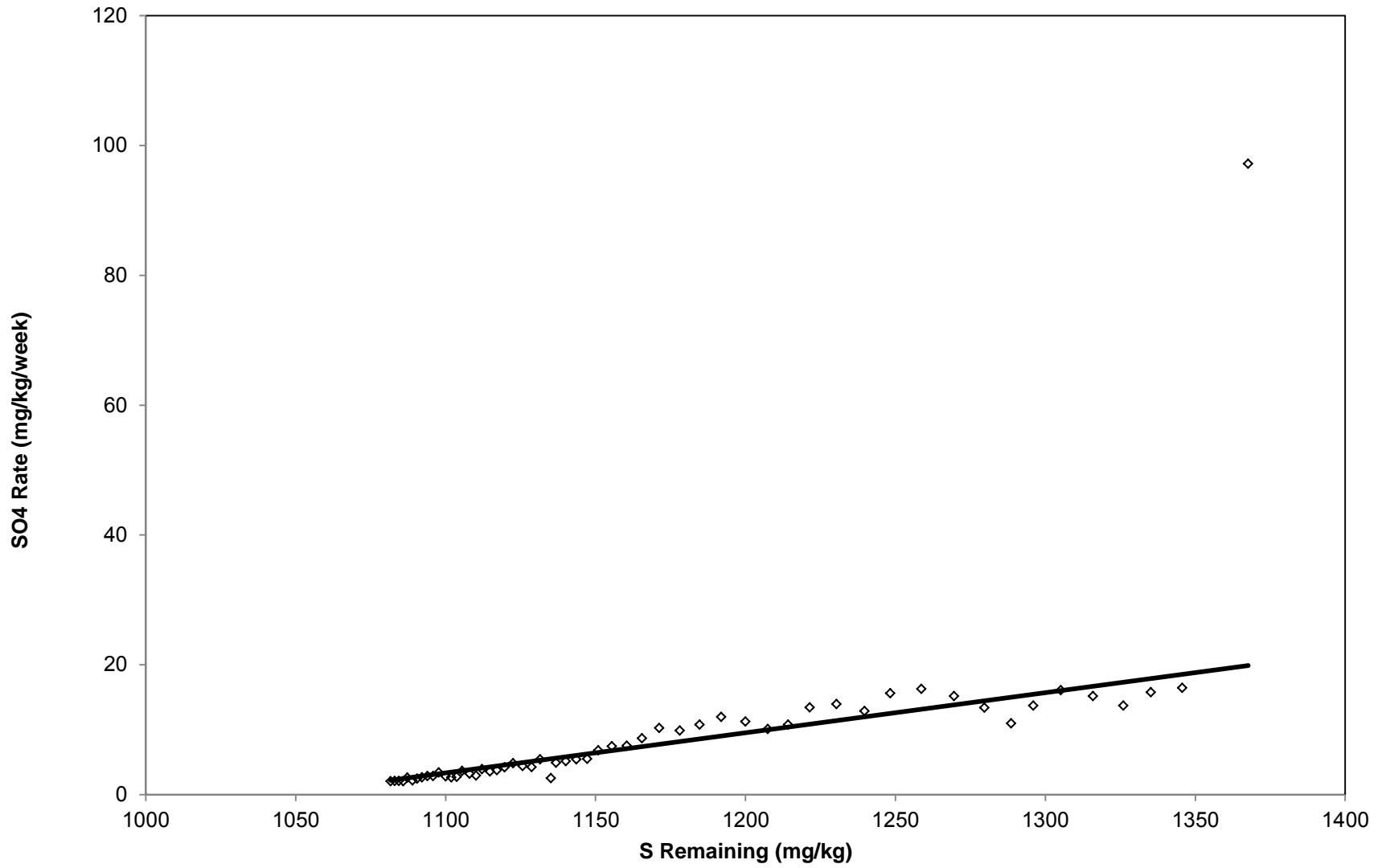

# ST\_Oct1\_5pm\_bulk

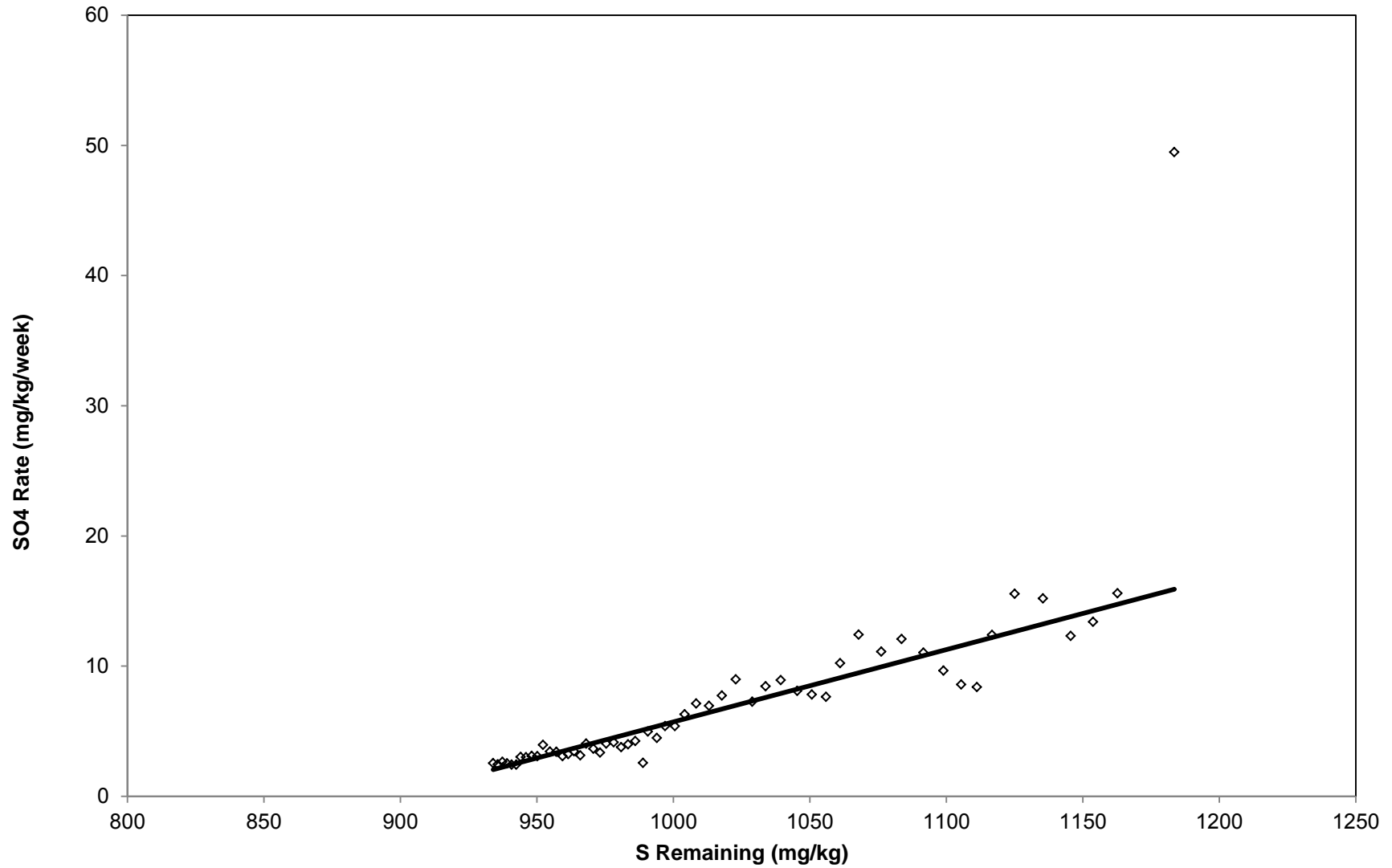

# ST\_Oct1\_5pm\_100

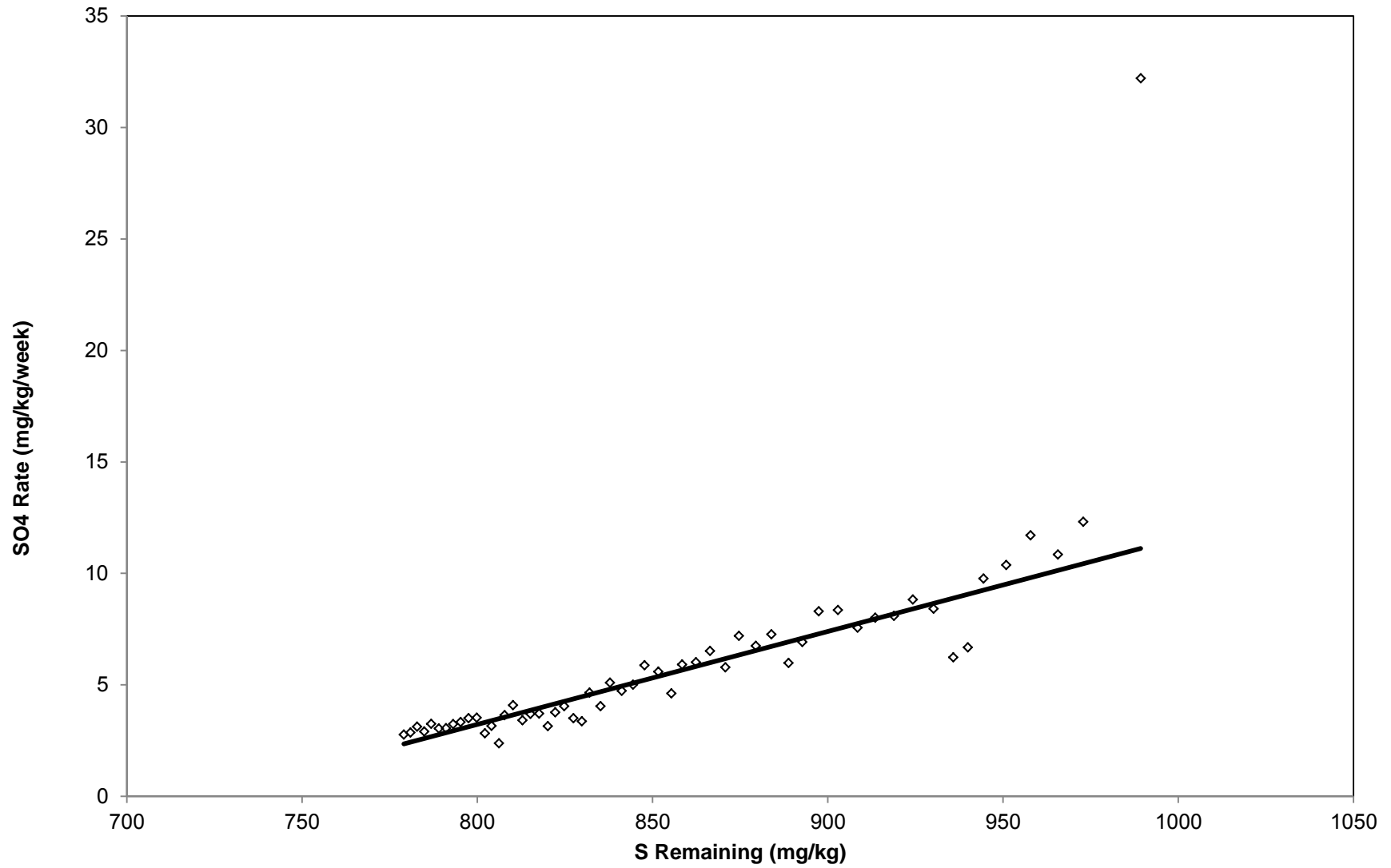

# ST\_Oct1\_5pm\_100\_200

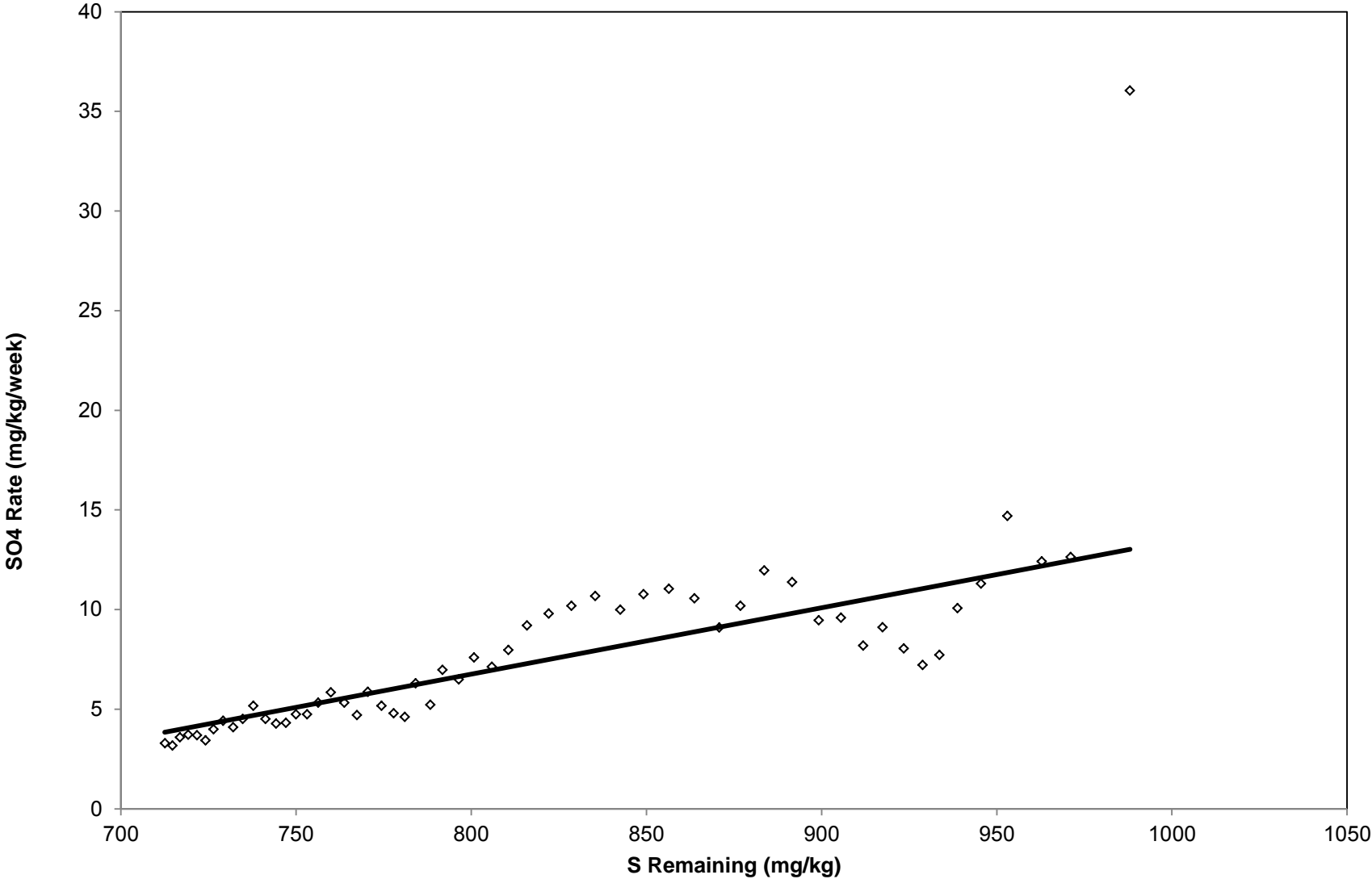

# ST\_Oct1\_5pm\_200

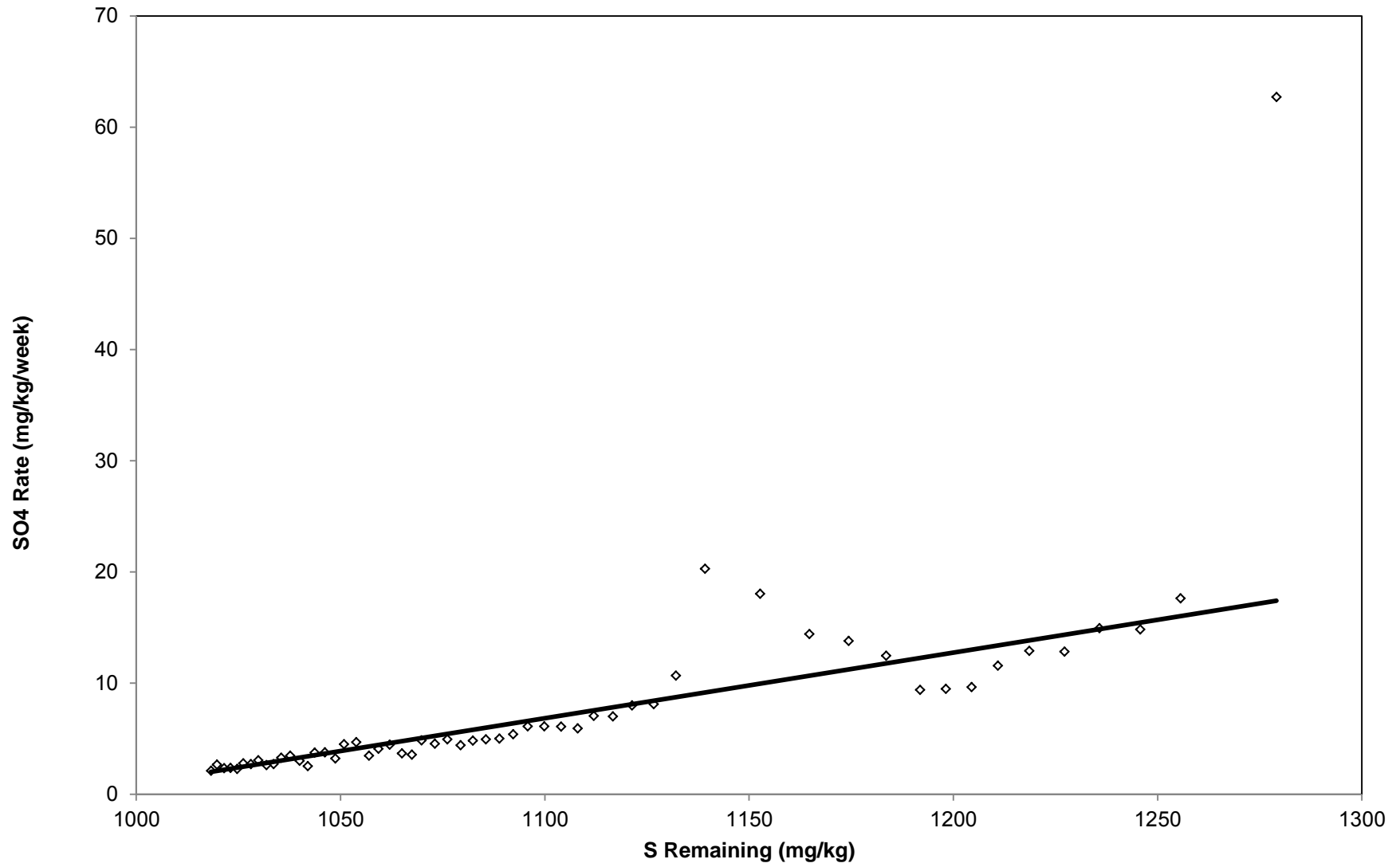

**Attachment D**

**2014 Update on Kinetic Test Data**



## Memo

---

<b>To:</b>	Jim Scott Jennifer Saran Andrew Ware	<b>Client:</b>	PolyMet Mining Corp.
<b>From:</b>	Stephen Day	<b>Project No:</b>	1UP005.001
<b>Cc:</b>	Laura Donkervoort Rosemarie Cocuaco	<b>Date:</b>	March 17, 2014
<b>Subject:</b>	NorthMet Project Kinetic Test Program Status and Recommendations – DRAFT		

---

### 1 Background

Kinetic tests (mainly humidity cells) were initiated for the NorthMet Project beginning in 2004 on samples of rock, Flotation Tailings and Hydrometallurgical Residues produced in a pilot plant according to overall program designs prepared following discussion between PolyMet Mining Inc. (PolyMet), Minnesota Department of Natural Resources – Lands and Minerals (MDNR-LAM) and SRK Consulting (Canada) Inc. (SRK). Results from these tests have been used at various junctures of the project to develop waste management plans and evaluate project environmental effects. Additional tests on LTVSMC tailings planned for dam construction have been started to evaluate that aspect of the project. In 2009, the program was modified in consultation with MDNR-LAM to stop some tests and modify the frequency of analysis of leachates based on trend interpretation (SRK 2009).

The purpose of this memorandum is to provide an update on the progress of the testwork and provide recommendations for modification to the program.

### 2 Approach

Some components of the program have now yielded over eight years of data on dissolution trends and are showing strong consistency of results. Furthermore, due to slow weathering processes documented by this program and similar programs performed under the direction of MDNR-LAM, few significant changes have been observed in the testing program compared to those reported previously in the last status report (SRK 2012).

For this reason, the approach taken for the current review was to compile comparative observations to determine where modifications can be made to the program. Experience at other mining projects shows there is significant value in continuing some representative tests to verify conclusions drawn from the current dataset as the mine moves into production.

The following sections provide observations on trends observed for each of the major programs (rock, flotation tailings, LTVSMC tailings) and resulting recommendations (summarized in Table 1).

With agreement from MNDR-LAM, testing of residues from the hydromet process produced in 2005 was stopped in 2009 and is not reported in this memorandum. Testing of one sample of hydrometallurgical residue produced from a 2009 pilot plant was started in April 2010 and is continuing. It should be noted that the 2009 hydrometallurgical pilot plant was run with limited concentrate, so it was necessary to run part of the pilot plant using batch processing rather than continuous processing. The batch approach was appropriate to answer metallurgical questions, but produced residue that is not expected to be representative of the NorthMet hydrometallurgical residue during operations. Consequently, plans for environmental testing of the 2009 pilot plant residue (other than the autoclave leach residue, which was produced by a continuous process) were discontinued.

### 3 Analysis Recommendations

Leachate analysis for continuing tests is being performed at a frequency agreed with MDNR-LAM (SRK 2009a). As the testwork continues, it is clear that trends evolve over periods of years rather than weeks or months, and that trend definition can be achieved with testing on an infrequent basis. Table 2 provides analysis schedule recommendations for all recommended ongoing tests.

SRK (2009b) provided a protocol for adjustment of analytical frequency based on pH trends. Due to the tendency for trends to develop slowly, the proposed schedule shown in Table 2 will be able to detect changes with sufficient resolution that increased analytical frequency is not needed. SRK recommends that the frequency be fixed as proposed in Table 2.

## 4 Rock Characterization Program

### 4.1 Observations

Currently, 24 humidity cell tests and 15 “size fraction” tests are operating with the breakdown by waste category and type as indicated in Table 1. Ongoing testwork shows that pH of leachates are consistent with the waste categories:

- No changes in Category 1 tests have been observed since the previous report (SRK 2012). pH variations are apparent but remain within historical ranges.
- Some Category 2/3 tests generated acid as described in previous reports but a number of tests are continuing to yield leachate pHs that are above the pH of the drainage water used to leach the samples and therefore imply a delay to onset of acidic leachate exceeding eight years.
- All continuing Category 4 tests have generated acid as previously reported. The testwork has demonstrated that most Category 4 rock can be expected to generate acid and that the

timeframe to onset is several years in most cases. The main observation for the continuing tests is the upward trend in copper release (Figure 1).

- All three ore composite samples are showing the same trend with pH being comparable to Category 2/3 rock.
- The parallel tests on size fractions and using the DNR Reactor test configuration has shown that differences in rates can be explained by differences in reactive surface area and water application ratio but the tests do not fundamentally change how rock weathering is interpreted.

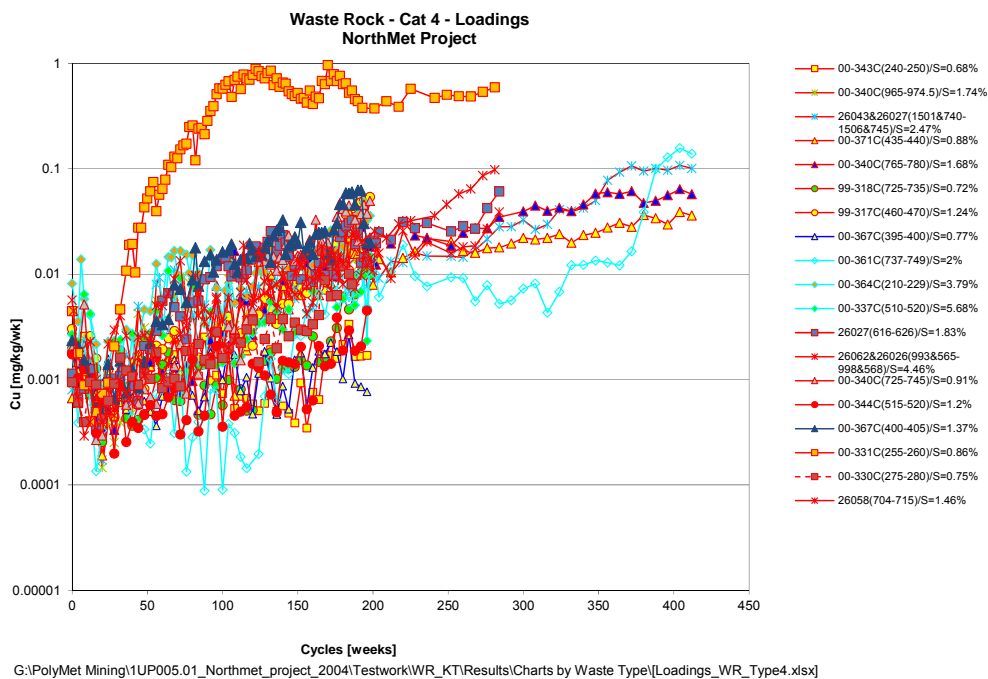

**Figure 1. Copper Release for Category 4 Samples**

Table 1. Status of Testwork, Findings and Recommendations

Program	Sub-program	Type of Test	Original Total Tests	Tests Operating	Duration (weeks)	Status	Conclusions	Recommendation and Rationale	Tests to Continue
Rock	Category 1	HCT	37	7	420	Stable, no change since last report.	Tests are confirming pH near neutral and varying within historical range.	Continue three tests to monitor range of S content. Demonstrate that Cat 1 does not generate acid.	3
Rock	Category 2/3	HCT	26	10	420	Eight tests are stable pH above 6 with no change from last report. One test (UM, S=0.2% is showing lower pH with variations within historical range. Metal release peaked several years ago.	Tests have shown the majority of samples in Cat 2/3 do not show pH depression below 5 for at least eight years. The majority of tests are maintaining pH above 6 indicating that acid generation under site conditions would not occur for at least eight years.	Continue three tests with lower S contents to evaluate use of a higher criterion for segregation of Cat 1 from 2/3. Continue one test at highest S content to evaluate delay to onset of acidic conditions.	4
Rock	Category 4	HCT	22	4	420	Two tests with S>=2% have pH<4. Two tests with S<1.7 have 4<pH<5 and declining but pH is within historical range. SO <sub>4</sub> is declining for these tests. Cu leaching rate is increasing for all four tests.	Continuing tests show acidic pH but no indication of further declines after 4 years.	Continue two tests to evaluate copper leaching. One test from each current pH group.	2
Rock	Ore	HCT	3	3	420	Results are very similar for all tests. pH stable at 5.	Average ore type materials show consistent behavior without generating severe acidity after eight years. Variability of oxidation rates for ore grade sulphur content (Cat 4) is shown by Cat 4 HCTs.	All three samples so show similar behavior. Continue 1 test to evaluate long term leaching of ore type materials.	1
Rock	All categories	Parallel HCT, DNR reactors	15	5 samples (3 additional tests per sample)	420	Tests are demonstrating stable leachate chemistry. Results remain consistent with lower rates for coarser size fractions but also influenced by pH of deionized water resulting in higher metal solubility for coarser fractions.	Tests have shown reactivity differences for size fractions.	Terminate all tests.	0
Flotation Tailings	Pilot Plant 1	HCT	13	13 (4 bulk, and 9 size fractions)	390 to 420	The majority of tests are yielding pHs above 7 showing pH recovery from as low as pH 6 earlier in test. Sulfide consumption is 50% in some cases and sulfate release continues to show declining trends. Samples with higher S content (from not using CuSO <sub>4</sub> during processing) initially showed higher metal release but all are showing steady decline. Metal release from lower S tailings is approaching historical lows.	Test work has shown that significant pH depression is not expected. The consumption of a significant fraction of the sulfide while continuing to generate alkalinity supports the conclusion that alkalinity generated by silicate weathering will permanently offset acid generated by sulfide oxidation.	Due to the consistency of trend after eight years of testing, a limited number of tests should continue to confirm the conclusion that acid generation will not occur. The P3 samples are proposed as they represent typical performance. The bulk, fines (-200 mesh) and coarse (+200 mesh) fractions have been selected.	3
Flotation Tailings	Pilot Plant 1	DNR reactors	13	13 (4 bulk, and 9 size fractions)	390 to 420	The trend is similar to the HCTs but with pH shifted down to mostly below 7. Otherwise trends are the same as HCTs. pH is tending upwards from historical lows.	The main factor resulting in differences is the small sample volume and higher liquid to solid ratio.	Due to the similarity with HCTs on the same material and explainable differences, all tests should be discontinued.	0
Flotation Tailings	Pilot Plant 2 and 3	HCT	8	8 (2 bulk, 6 size fractions)	270	These tests showed decreasing pH initially but pHs have not decreased below what appears to be a strong buffered pH of about 7.3 which has been maintained for four years. Long term decline in sulfate release is observed. Alkalinity has been leached at a higher level than the PP1 tests which may explain the higher and sustained pH. As a result, metal leaching has been observed at low levels.	The testwork has shown that tailings generated by Pilot Plants 2 and 3 have been able to sustain higher pHs and lower metal leaching. These tailings had lower S content than PP1 and the results are therefore consistent with PP1 - lower S results in less acid generation and higher alkalinity.	Since these tailings demonstrate the performance with lower S content, it is recommended that one set of tests (bulk, +200 and -200) be continued in parallel with PP1 to conform that higher pH can be sustained. PP2 is proposed as it contains the highest sulphur content.	3
Flotation Tailings	Pilot Plant 2 and 3	DNR reactors	8	8 (2 bulk, 6 size fractions)	270	The trend is similar to the HCTs but with lower pH. A dip in pH to below 7 was apparent earlier in the program which was not apparent in the HCTs. The distinctive "buffered" chemistry is apparent but at lower pH.	The main factor resulting in differences is the small sample volume and higher liquid to solid ratio.	Due to the similarity with HCTs on the same material and explainable differences, all tests should be discontinued.	0
Flotation Tailings	Scavenger Tailings	HCT	12	12 (3 bulk, 9 size fractions)	200	The tests showed the same general trend as PP1 with pH declining then increasing, though the lowest pH was no lower than 6.8. One test showed an unusual "sawtooth" pH trend resulting in pHs to 6.5 which is being evaluated with the laboratory. The pH depression was accompanied by detectable increase in metal leaching but two orders of magnitude below that of PP1 samples.	Results from these tests were consistent with those of other programs and demonstrate that pH depression and metal leaching are linked to S content. None of the tailings samples tested in any program have generated leachate at a pH below that of the deionized water.	Due to the consistency with other long term testwork, it is recommended that testing of the Oct 1 9 am group be continued as it contains the highest sulphur content.	3
Flotation Tailings	Scavenger Tailings	DNR reactors	12	12 (3 bulk, 9 size fractions)	200	The trends are similar to the HCTs but with a lower pH.	The main factor resulting in differences is the small sample volume and higher liquid to solid ratio.	Due to the similarity with HCTs on the same material and explainable differences, all tests should be discontinued.	0
LTVSMC Tailings	Borrow materials	HCT	5	5	160	All tests are showing stable leachate with pH above 7.3, stable alkalinity and sulfate release below 1 mg/kg/week. Very low, barely detectable metal leaching is occurring.	The results are consistent with the low sulfide content and excess of carbonate minerals. A trend toward lower pH is not expected.	Discontinue all tests.	0
Flotation Tailings on LTVSMC Tailings		Column	Two LTVSMC tailings controls, four layered tests	Two LTVSMC tailings controls, four layered tests	390	These tests were designed to evaluate geochemical effects from placing Flotation tailings on LTVSMC tailings. They are yielding stable trends that are consistent with the mineralogy of the samples and the parallel HCTs. Results are similar between tests despite testing different variables. The LTVSMC tailings are removing As and V leached from Flotation tailings. A weak Ni removal effect is apparent.	The testwork shows that placing Flotation tailings on LTVSMC tailings does not seem to contribute to leaching of LTVSMC tailings but LTVSMC tailings may be beneficial in removing some components leached from Flotation Tailings. The removal process is probably occurring via adsorption.	Due to the potential value of LTVSMC tailings to remove metals from Flotation leachate by adsorption, continuation of some testwork is recommended to evaluate "break through" effects. Recommended testing includes - Maintain one control due to similar performance of both (coarse selected). Monitor bottom port only. - Maintain the two P1 experiments because they are leaching highest As and are likely to breakthrough sooner. Monitor top and bottom ports only. - Perform testwork on decommissioned columns to look for precipitates.	One control, two column sets
Hydrometallurgical Residue		HCT, SFE, DNR Reactor	3	3	165	Leachate chemistry reflects dissolution of soluble components. pH has stabilized at near 5 as dissolution of the residue continues to occur.	Due to the high liquid to solid ratio, the testwork represents a very long duration under natural site conditions.	Discontinue both tests.	0

Source: G:\PolyMet Mining\1UP005.01\_Northmet\_project\_2004\Reports\2013-11\_KT\_Update[TestStatusSummary\_1UP005001\_SJD\_REV00.xlsx]

**Table 2. Analytical Schedule**

Parameter Group	Original Schedule	Current Schedule	Recommended
Leachate recovery	Weekly	Weekly	Weekly
pH, conductivity	Weekly	4-weekly	Quarterly
Alkalinity, sulfate	Bi-weekly	4-weekly	Quarterly
ORP, acidity	Weekly, bi-weekly	4-weekly	None
Total inorganic carbon	Bi-weekly	None	None
Fluoride, chloride	Bi-weekly	None	None
ICP ES Elements	4-weekly (0, 4, 8, 12, etc.)	None	None
ICP MS Elements	4- weekly (2, 6, 10, etc.)	8-weekly (2, 10, 18, etc)	Twice annually

## 4.2 Recommendations

Ten samples are been recommended for continuation (Table 3) with the following objectives:

- Validate that Category 1 rock does not generate acidic leachate. Three samples were selected to cover the range of sulfur concentration.
- Continue three tests with lower S content in Category 2/3 as this may provide data to determine if the segregation criterion is appropriate.
- Continue one test at higher S content in Category 2/3 that currently has not generated acid to evaluate delay to onset of acidic conditions.
- Continue two Category 4 tests (one from each current pH group) to evaluate the copper leaching trend.
- Continue testing on one ore sample to monitor long term performance of typical ore type materials.

Implementation of these recommendations will result in 14 of the current tests being discontinued. For the residues from the tests, optical mineralogical characterization is recommended to evaluate oxidation features.

**Table 3. Recommended Rock Humidity Cells for Continuation**

Sample	Rock Type	Waste Category	S %	Reasoning
DDH-00-334C(580-600)-14	Troctolitic	1	0.06	Higher S
DDH-00-367C(290-310)-51	Troctolitic	1	0.04	Mid-Range S
DDH-26064(44-54)-56	Troctolitic	1	0.02	Lowest S
DDH-00-350C(580-600)-17	Troctolitic	3	0.19	S<0.2, evaluate segregation criterion
DDH-00-369C(335-345)-34	Troctolitic	3	0.18	S<0.2, evaluate segregation criterion
DDH-00-367C(170-175)-54	Troctolitic	3	0.51	High S, test onset, lower pH in this group
DDH-00-357C(535-540)-23	Ultramafic	3	0.2	S=0.2, lowest pH leachate
DDH-00-371C(435-440)-19	Troctolitic	4	0.88	Acidic but pH>4
DDH-00-361C(737-749)-62	Virginia	4	2	Acidic and pH<4
P2-0-67		4	0.9	Typical of average ore

Source: G:\PolyMet Mining\1UP005.01\_Northmet\_project\_2004\Reports\2013-11\_KT\_Update\[TestStatusSummary\_1UP005001\_SJD\_REV00.xlsx]

## 5 Northmet Project Flotation Tailings Characterization Program

### 5.1 Observations

The current tailings test program consists of 66 tests in HCT and DNR reactor configurations on Flotation Tailings samples obtained from four different pilot plant runs. The longer tests have run for more than eight years and nearly 50% of sulfur has been depleted in some cases. Consistent patterns have emerged from all these programs:

- No tests have generated pH lower than the deionized water used in the tests and detectable alkalinity is still being measured.
- Sulfide oxidation rates declined as sulfur was depleted indicating that the oxidation rate is not zero order. This was evaluated previously by SRK (2012).
  - Leachate pH declined initially, reached a low point after a few years than recovered. This pH depression is interpreted as representing slightly accelerated acid generation rates. This implies that in the long term there is a low likelihood of acidic conditions developing.
- Differences in sulfur content explain differences in oxidation rates and the degree to which pH is depressed. Lower pHs and higher oxidation rates are measured for samples containing higher sulfur content.
- Lower pHs result in accelerated metal (Ni, Co) leaching though only for the Pilot Plant 1 samples.
- The DNR reactors showed similar pH trends but at lower pHs. This is interpreted as reflecting the higher liquid-to-solid ratio used in the test compared to HCTs resulting in a stronger influence from the deionized water pH.

## 5.2 Recommendations

The following changes to the program are recommended:

- One set of tests from each of the major programs (PP1, PP2/PP3 and Scavenger tailings) should be continued to validate long term performance. For each set of tests, the bulk, +100 mesh and -200 mesh test would be continued and the -100+200 mesh sample stopped. The sample sets having the highest sulfur content in the bulk tailings and produced in a pilot run with copper sulfate activator added would be selected for continuation.
- All DNR Reactor tests should be discontinued because they are not providing additional information beyond that of the humidity cells.

The resulting number of continuing tests will be nine. For discontinued tests, the following analyses are recommended:

- Total sulfur analysis to provide mass balance confirmation with the original sample and leached sulfate.
- Optical mineralogy to evaluate dissolution features.

## 6 LTVSMC Tailings Borrow Sources Characterization Program

### 6.1 Observations

Five samples of weathered LTVSMC tailings are being tested in humidity cells. These samples have shown stable leachate with slightly basic pH consistent with low initial sulfur content and elevated carbonate content. No significant changes in leachate pH are anticipated.

### 6.2 Recommendation

It is recommended that these tests be terminated because leachate chemistry is stable and no long term changes are expected.

## 7 NorthMet Flotation Tailings on LTVSMC Tailings Column Tests

### 7.1 Observations

These tests were designed to evaluate geochemical effects from placing Flotation Tailings on LTVSMC tailings. The tests are constructed as sequential columns with oxygen control at intermediate sampling points. The tests have been operating for nearly eight years.

The following are major observations from this test program:

- Two control tests containing only LTVSMC tailings (coarse and fine fractions) yielded basic pH leachate containing high alkalinity concentrations which increased along the flow path. Some differences were observed between the two tests but leachate characteristics were generally similar and consistent with pH. Long term flushing trends were apparent for a number of parameters including sulfate, arsenic and molybdenum.
- All four column sequences testing the influence of Flotation Tailings on LTVSMC tailings showed similar results.
- Leachate from the Flotation Tailings had slightly lower pH when compared to LTVSMC tailings and showed declining sulfate release indicating depletion of sulfide minerals. Overall leachate chemistry was similar to humidity cells yielding leachate pH above 7. Metal concentrations were very low and accelerated leaching comparable to lower pH humidity cells was not apparent.
- Leachate from Flotation Tailings did not appear to influence leaching of the LTVSMC tailings but the LTVSMC tailings appeared to remove arsenic, vanadium and to a lesser extent nickel from Flotation Tailings leachates (examples shown in Figure 2). This is suspected to be a result of adsorption to LTVSMC tailings.

## 7.2 Recommendations

Because the LTVSMC tailings may be important in limiting metal leaching from Flotation Tailings, the following continuation of tests is recommended to evaluate breakthrough effects:

- Continue one set of controls due to similar performance of both coarse and fine LTVSMC tailings. The coarse fraction has been selected. Monitor bottom port only.
- Continue the two P1 sequence tests because they are leaching highest arsenic and are likely to breakthrough sooner. Monitor top and bottom ports only.

For decommissioned tests, testing of the column residues is recommended to determine where adsorption occurred in the column.



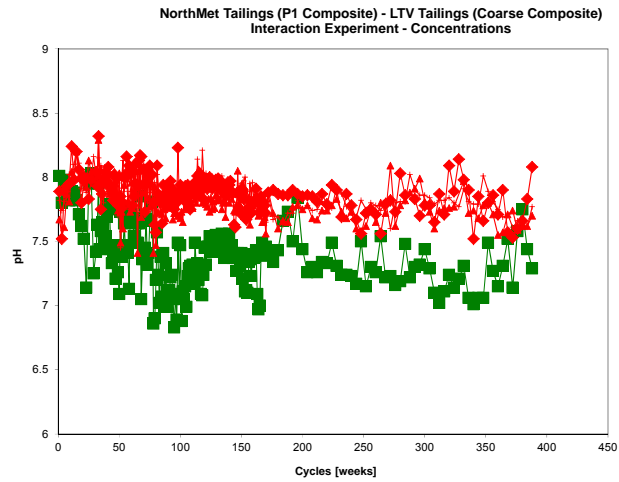

\\van-svr0\GE\_Projects\PolyMet Mining\1UP005.01\_Northmet\_project\_2004\Testwork\Tailings\3.KineticTests\Results\Charts\conc\_LTV\_P1coarse.xls

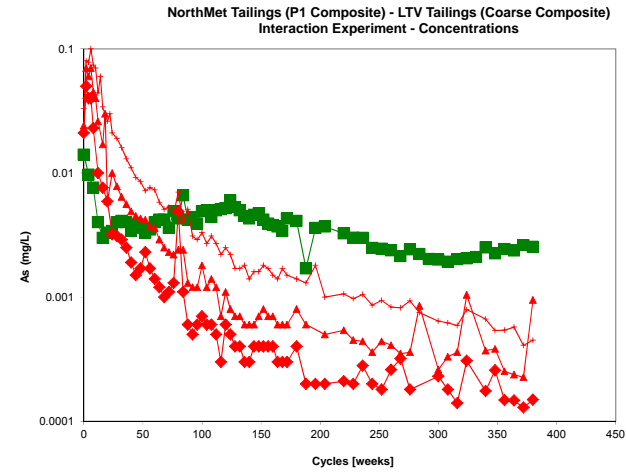

\\van-svr0\GE\_Projects\PolyMet Mining\1UP005.01\_Northmet\_project\_2004\Testwork\Tailings\3.KineticTests\Results\Charts\conc\_LTV\_P1coarse.xls

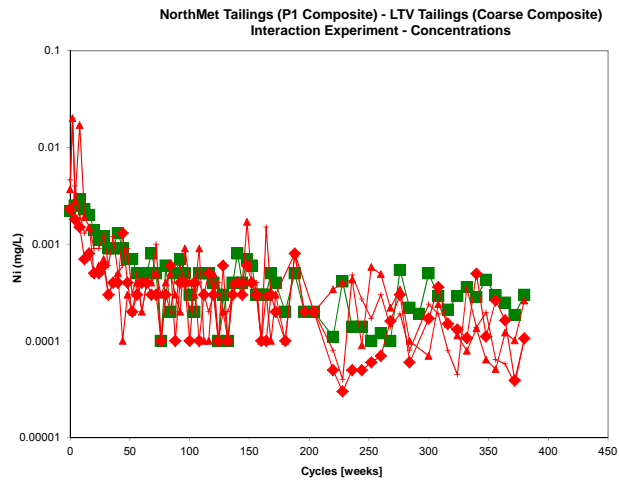

\\van-svr0\GE\_Projects\PolyMet Mining\1UP005.01\_Northmet\_project\_2004\Testwork\Tailings\3.KineticTests\Results\Charts\conc\_LTV\_P1coarse.xls

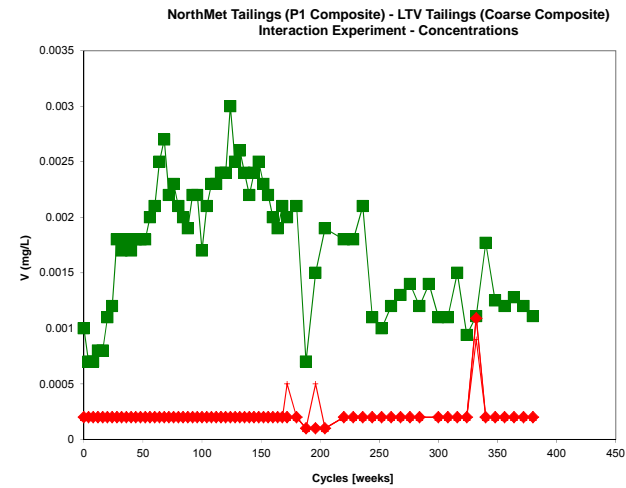

\\van-svr0\GE\_Projects\PolyMet Mining\1UP005.01\_Northmet\_project\_2004\Testwork\Tailings\3.KineticTests\Results\Charts\conc\_LTV\_P1coarse.xls

Figure 2. Examples of Leaching Trends for Flotation and LTVSMC Tailings Columns

## 8 Hydrometallurgical Residue

### 8.1 Observations

One sample is being tested in humidity cell, shake flask and DNR Reactor configurations. All tests show trends consistent with flushing of soluble products. pH has stabilized at a consistent level.

### 8.2 Recommendation

Discontinuation of all three tests is recommended because the amount of flushing that has occurred far exceeds expected flushing under field storage conditions, and leachate chemistry is either stable or showing downward trends.

## 9 Conclusions

Long term (exceeding eight years in some cases) kinetic testwork for the NorthMet Project has yielded consistent results that support the interpretations made earlier in the program used to develop waste management criteria and water chemistry predictions.

As a result, SRK recommends that continuation of a limited number of tests is appropriate to validate predicted long term pH stability. In addition, based on the data obtained thus far, changes in leachate chemistry are expected to be detected with very low frequency analysis. It is recommended indicator parameters (pH, conductivity, sulfate and alkalinity) be measured quarterly and metals measured twice annually.

SRK Consulting (Canada) Inc.

*“DRAFT”*

---

Stephen Day PGeo  
Corporate Consultant (Geochemistry)

Reviewed by:

*“DRAFT”*

---

Laura Donkervoort, M.Sc.  
Consultant (Geochemistry)

**Disclaimer**—SRK Consulting (Canada) Inc. has prepared this document for PolyMet Mining Corp.. Any use or decisions by which a third party makes of this document are the responsibility of such third parties. In no circumstance does SRK accept any consequential liability arising from commercial decisions or actions resulting from the use of this report by a third party.

The opinions expressed in this report have been based on the information available to SRK at the time of preparation. SRK has exercised all due care in reviewing information supplied by others for use on this project. Whilst SRK has compared key supplied data with expected values, the accuracy of the results and conclusions from the review are entirely reliant on the accuracy and completeness of the supplied data. SRK does not accept responsibility for any errors or omissions in the supplied information, except to the extent that SRK was hired to verify the data.

## 10 References

SRK Consulting. 2009a. RS82 - Update on Use of Kinetic Test Data for Water Quality Predictions – DRAFT 02. Memorandum to Kim Lapakko, MDNR. February 7, 2009.

SRK Consulting. 2009b. pH Criteria for Modification to Kinetic Test Program - NorthMet Project. Memorandum to Jim Scott. April 28, 2009.

SRK Consulting. 2012. Update on Kinetic Test Data, NorthMet Project – DRAFT. Memorandum prepared for PolyMet Mining. SRK Project 1UP005.001. October 19, 2012.

**Attachment E**

**Physical Model Study of Fine-Grained Tailings Delta Formation under Various Flow Conditions: Project Report**

# **Physical Model Study of Fine-Grained Tailings Delta Formation under Various Inflow Conditions: Project Report**

Project Report Number 551

Prepared by

**St. Anthony Falls Laboratory  
University of Minnesota**



For

**Barr Engineering Company**

**March 2011**

## **Project General Information**

### **Title:**

Physical Model Study of Fine-Grained Tailings Delta Formation under Various Inflow Conditions

### **Principal Investigator:**

Jeffrey Marr

### **Project Team:**

Jeffrey Marr (PI), Chris Paola (Co-PI), Craig Taylor, Sara Johnson, Aaron Ketchmark, & Anne Haws

### **Institution:**

Regents of the University of Minnesota

### **Sponsor:**

Tom Radue  
Barr Engineering Company  
4700 West 77<sup>th</sup> Street  
Minneapolis, MN 55435-4803  
Direct Dial: 952-832-2871  
E-mail: [tradue@barr.com](mailto:tradue@barr.com)

### **Contact Information:**

Jeffrey DG Marr, MS, PE  
Associate Director of Applied Research  
St. Anthony Falls Laboratory  
University of Minnesota  
2 Third Ave, SE  
Minneapolis, MN 55414  
USA

Office: 612.624.4427  
Cell: 612.716.7309  
Fax: 612.624.4398  
E-mail: [jmarr@umn.edu](mailto:jmarr@umn.edu)  
Web: [www.safl.umn.edu](http://www.safl.umn.edu)

The University of Minnesota is committed to the policy that all persons shall have equal access to its programs, facilities, and employment without regard to race, religion, color, sex, national origin, handicap, age or veteran status.

## Table of Contents

<b>Executive Summary</b> .....	5
<b>1.0 Introduction</b> .....	6
<b>2.0 Tailings Supply Information</b> .....	8
<b>3.0 Phase I – 1D Flume Experiments</b> .....	10
3.1 Phase I Experimental Design .....	10
3.1.1 Design Theory .....	10
3.1.2 Phase I Apparatus.....	11
3.1.3 Phase I Experimental Procedure .....	12
3.1.4 Phase I Sampling Plan.....	12
3.2 Phase I Results .....	13
3.2.1 Qualitative Observations .....	13
3.2.2 Slope Measurements .....	14
3.2.3 Sediment Measurements .....	16
3.3 Phase I Experiment Conclusions .....	19
<b>4.0 Phase II – 2D Basin Experiments</b> .....	20
4.1 Scaling Approach.....	20
4.2 Experimental Setup.....	22
4.3 Experimental Procedure.....	23
4.4 Phase II Data Collection .....	24
<b>5.0 Phase II – Results</b> .....	29
5.1 Pool and Scrape Sample Particle Size Analysis .....	29
5.1.1 Sieve Analysis of Scrape Samples .....	29
5.1.2 Horiba® Laser Diffraction Analysis of Pool Samples and Bottomset Scrape Samples .....	38
5.2 Hydraulic Conductivity.....	40
5.3 Porosity .....	42
5.4 Stratigraphy.....	42
5.4.1 Suction Cores .....	42
5.4.2 Freeze Slices.....	47
5.5 Topographic Scans.....	52
<b>6.0 Phase II – Discussion</b> .....	57
6.1 Phase II Results.....	57
6.2 Delta Drainage .....	62

6.2.1	Low Permeability .....	62
6.2.2	Suspended Capillary Water .....	62
6.2.3	Influence of Fluvial Deposition.....	64
6.2.4	Field Delta Drainage .....	64
<b>7.0</b>	<b>Conclusions</b> .....	<b>65</b>
<b>8.0</b>	<b>References</b> .....	<b>66</b>
	Appendix A – Feed Material Grain Size Distribution .....	67
	Appendix B – Scrape Sample Grain Size Analysis .....	68
	Appendix C – Comparison of Grain Size Distribution by Volume (Horiba® Laser Diffraction) and by Weight (Sieve and Hydrometer Tests from SET Labs) .....	75
	Appendix D – Videos.....	76

CONFIDENTIAL



## Executive Summary

---

The University of Minnesota's St. Anthony Falls Laboratory (SAFL) was contracted by Barr Engineering Co. to perform a series of physical laboratory models related to tailings delta formation as part of an Environmental Impact Study for the development of new copper/nickel mine in northern Minnesota. Phase I of the project involved 1D flume experiments, at field scales, to evaluate the potential for debris flow behavior and channelization as well as to develop an initial beach slope prediction matrix. In Phase II of the project, two laboratory scale deltas were grown in SAFL's delta basin. The delta experiments were designed such that the laboratory scale delta would have a similar degree of channelization as the field scale delta. The Phase II experiments also looked at the range of fines (<74 micron) retention in the deposit with focus on generated deposits that represent lower limit of fines concentration in the final surface of the deposit.

Prototype tailings were used in the Phase I study and were provided by Polymet. Phase I experiments indicated that debris flow-type behavior will not be the transport and depositional mechanism rather the delta be constructed from fluvial-braided processes and channelized. Phase I also indicated that, within the expected range of slurry discharges, the beach slope will likely range between 0.5% and 2%.

Phase II of the project focused on 2D basin experiments to evaluate grain size sorting, heterogeneity, and hydraulic conductivity in the deposit. An 5 m by 5 m by 0.4 m deep research basin located at SAFL-UMN was used for the tests. The degree of fines retention within the delta was measured from surface scrape samples taken from the beach at various times during basin operation. Scrape samples were analyzed for coarse/fine fraction by washing the samples through a 74 micron sieve. The degree of channel-lens formation in the deposit was investigated on two cross-sectional freeze slices taken from the Run 2 deposit. The Phase II results showed clear visual indication of sorting. Grain size sorting was present in the form of downstream fining (particle size segregation toward smaller grain size along the flow) and coarse/fine lenses (internal structures formed by filling abandoned flow channels with sediment). The results of Phase II suggest that the field scale delta will likely exhibit significant heterogeneity related to channelization. The field delta should have a minimum of 30% (by weight) fines retention throughout. Hydraulic conductivity measurements made on the laboratory deposits showed a decrease in conductivity with distance from the slurry source, suggesting that the groundwater transport through the delta will likely be greater at the upstream end than at the downstream end.

Prediction of the degree of water retention in the field scale deposit cannot be done conclusively. The estimated deposit thickness and the Soil-Water Characteristic Curve (SWCC) for the tailings suggests that suction (the tailings ability to wick water) will not be great enough to keep the deposit saturated; however, internal structures such as lenses, grain size discontinuities, or micro-pore structure developed from natural deposition may increase the suction pressure of the material and decrease permeability.

# 1.0 Introduction

---

The University of Minnesota's St. Anthony Falls Laboratory (SAFL) was contracted by Barr Engineering Co. (BARR) to perform a series of physical laboratory models related to tailings delta formation as part of an Environmental Impact Study for the development of a new copper/nickel mine in northern Minnesota. At the site, a tailings basin would be created to collect sediment from process water effluent. The tailings production would be approximately 32,000 tons/day and would discharge to the tailings basin as a 31.5% solids (by weight) slurry via a pressurized pipe. Multiple input points would be designed around the perimeter of the basin giving operators control on feed-points.

It is not feasible to reproduce, in the same experiment, both the local flow and sediment-transport conditions and a fully developed channel network. Accordingly, our strategy was to run two sets of experiments: one to study field-scale flow and sediment dynamics in a relatively narrow, long flume (Phase I); and the second to study channelization and its effect on deposit heterogeneity at a substantially reduced scale in an open basin (Phase II).

Phase I of the project involved 1D flume experiments, at field scales, to evaluate the potential for debris flow behavior and channelization as well as to develop an initial beach slope prediction matrix. These experiments were conducted in a 6-inch wide glass-walled flume with a metered slurry input at the proximal end and a pooled tailbox at the distal end.

Phase II of the project focused on 2D basin experiments to evaluate grain size sorting, heterogeneity, and hydraulic conductivity of the deposit. The goals of the 2D experiments were to 1) determine the expected lower limit of fines concentration in the deposit, 2) determine the degree of grain size segregation both vertically and horizontally within the deposit, and 3) evaluate the potential range of hydraulic conductivity throughout the model delta.

Phase II was conducted in a rectangular research basin located at SAFL. The research basin is designed for studying deltas and tailings ponds and is referred to as DeltaBasin2. Figure 1 is a schematic of the delta basin. The delta basin had inlet controls, pool level controls, overhead camera, and a topographic scanning system. The data collected for Phase II included grain coarse/fine fraction, hydraulic conductivity, topography, aerial images, freeze slices, and lens grain size distributions. The experimental facility, setup, and data collection is discussed in more detail in the sections below.

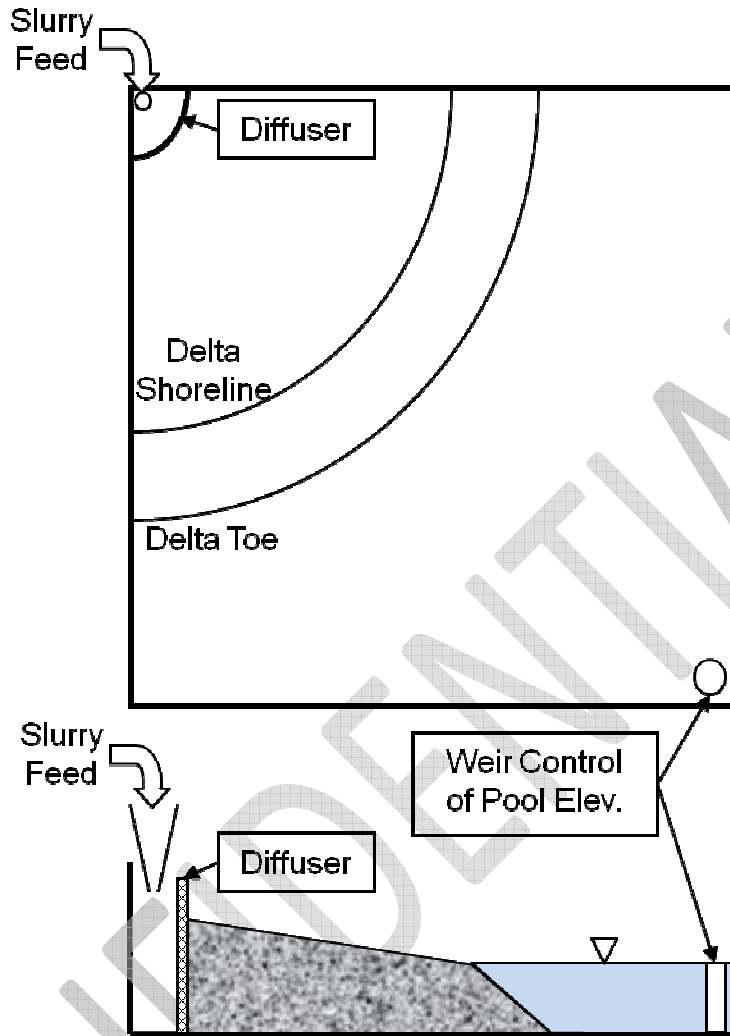

Figure 1 – Schematic of the delta basin. Top is plan view of the basin. Bottom is section view.

## 2.0 Tailings Supply Information

---

At the field site, the tailings would be delivered to the basin in the form of a high concentration slurry. Under this design scenario, the slurry is expected to deposit sediment to create a sloping subaerial deposit termed the “beach”. The planned slurry flow rate is 31.1 cfs with a solids fraction of 31.5% by weight (Table 1). The slurry would be delivered to the tailings basin at several locations, each location forming a radial fan with a spatial scale on the order of hundreds of feet. Laboratory testing focused on a single feed point.

The standard definition for the division between clay and silt size particles and between silt and sand size particles is 0.005 mm and 0.075 mm. The tailings material used in this study was prototype material provided by Polymet and was composed of fine sand to clay-sized particles, with a  $D_{50}$  (median grain size) of 60 microns (See Appendix A for Soil Engineering Testing, Inc. grain size distribution). By weight, the material averages around 41% (between 35 and 48%) of the tailings sediments were greater than 74 microns (also used as the division for “fine- “ or “coarse-grained” material). Laser diffraction analysis of the tailings indicate that, although the material had many clay-sized particles, it did not contain much mineral clay.

It should be noted that PolyMet provided two grind types (grain size distributions) for their tailings however the difference between the two was minor. The grain sizes reported here are for the final grind. The preliminary grind was similar with 32% of the sediment greater than 74 microns by weight. Due to a limited supply of tailings from the pilot plant, the first run and 1D flume testing was conducted with the preliminary grind tailings supply, and the second run was conducted with the final grind tailings supply. It is believed that the two grinds are similar enough that they will produce similar delta characteristics.

**Table 1 – Slurry Source Information**

<b>Item</b>	<b>Qty</b>	<b>Unit</b>
Solids Production*	1452	tons/hour
Tailings Production (wt)	34848	tons/day
Tailings Production (wt)	806.7	lb/sec
Liquor Flow*	3161	tons/hour
Liquor Flow	75864	tons/day
Liquor Flow	1756.1	lb/sec
Slurry Flow*	4614	tons/hour
Slurry Flow	110736	tons/day
Slurry Flow	2563.3	lb/sec
Solids Fraction by wt in slurry*	31.5	% wt
Specific Gravity of Solids*	3	
Specific Weight of Solids	187.2	lb/ft <sup>3</sup>
Specific Gravity of Slurry*	1.322	
Specific Weight of Slurry	82.5	lb/ft <sup>3</sup>
Tailings (Solids) Production (volume)	4.3	ft <sup>3</sup> /sec
Water Flow Rate (volume)	28.1	ft <sup>3</sup> /sec
Volumetric Flow Rate for Slurry	31.1	ft <sup>3</sup> /sec
Volumetric Flow Rate for Slurry*	13947	gal/min
Solids Fraction by Volume	13.90%	% vol

\* Value provided by Barr Engineering.

## 3.0 Phase I – 1D Flume Experiments

### 3.1 Phase I Experimental Design

#### 3.1.1 Design Theory

The 1D flume experiment was run approximately at field scale. The sediment and water flows in the flume were adjusted to model different locations on the tailings beach. When Phase I was set up, we had no way of knowing the general nature of the flow regime to be expected on the beach, i.e. channelized fluvial versus some form of mass or debris flow. One of the main goals of Phase I was to determine this. For design purposes, we assumed that the tailings beach would have sheet flow (i.e. no flow channelization or braiding) over a 180° fan. On a radial beach, the water flow spreads out as it flows away from the inlet. Although the total water discharge across the delta does not change with radial position, the unit discharge (flow per unit width) decreases as the flow spreads. The relationship between radial position and unit discharge is given by equations 1 and 2 (Figure 2). Once the unit discharge has been determined for any given radius, the required equivalent flume water discharge can be determined by multiplying by the flume width (6 inches). Results from these calculations are included in Table 2.

$$L(r) = \pi * r \quad (1)$$

$$q(r) = \frac{Q_w}{L(r)} \quad (2)$$

Where:  $Q_w$  = Water discharge at inlet

$r$  = Radius

$L$  = Arc length of the delta

$q$  = Unit discharge of water

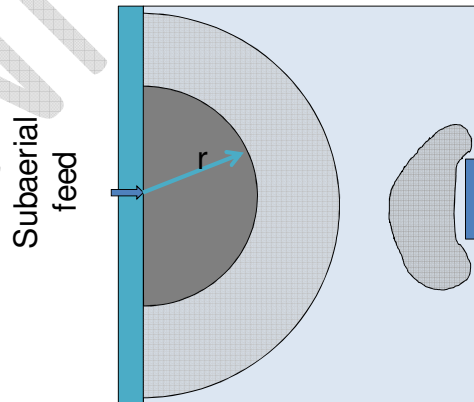

Figure 2 – Diagram of 180° delta fan.

**Table 2 – Radial Position and Model Discharge**

<b>r (ft)</b>	<b>L (ft)</b>	<b>qw (cfs/ft)</b>	<b>Model (cfs)</b>	<b>Model (GPM)</b>
50	157	0.198	0.0990	44.40
100	314	0.099	0.0495	22.20
150	471	0.066	0.0330	14.80
200	628	0.049	0.0247	11.10
250	785	0.040	0.0198	8.90
300	942	0.033	0.0165	7.40
350	1100	0.028	0.0141	6.30
400	1257	0.025	0.0124	5.60
450	1414	0.022	0.0110	4.90
500	1571	0.020	0.0099	4.40
550	1728	0.018	0.0090	4.00
600	1885	0.016	0.0082	3.70
650	2042	0.015	0.0076	3.40
700	2199	0.014	0.0071	3.20
750	2356	0.013	0.0066	3.00
800	2513	0.012	0.0062	2.80

Like the water discharge, the sediment discharge also decreases with distance from the inlet. This is due not only to spreading of the flow across delta but more importantly to sediment being deposited over the length of the delta. In other words, the sediment unit discharge and concentration decrease with increasing radial position.

Phase I experiments focused on observing the character of the flow and quantifying slopes of the delta for various water discharge and sediment concentrations using prototype tailing provided by PolyMet. The experiments provided a clear picture of the flow regime to be expected and an understanding of the range of possible slopes and sediment concentrations as functions of radial position for the tailing beach being modeled.

### **3.1.2 Phase I Apparatus**

The testing setup for the 1D study consisted of a mixing tank, a six-inch flume, and a tail box. The mixing tank was a 220-gallon stainless steel cylindrical tank with a conical bottom. A 0.25 hp Lightin<sup>®</sup> tank mixer with a seven-inch propeller was used to keep the solids fraction of the slurry in suspension. The outlet of the mixing tank was 8.5 feet above the inlet of the flume. Slurry was conveyed from the mixing tank to the flume inlet via 24 feet of 2-inch pvc pipe. There were ball valves at each end of the pipe and one gate valve at the downstream end to control the flow rate. The flow rate was measured using an inline Seametrics<sup>®</sup> EX-81 Electromagnetic Flow Sensor. The flume was 6 inches wide by 22 feet long with no slope and glass walls. Figure 3 is an image of the upstream half of the flume. After this picture was taken a diffuser grate was added two feet downstream of the inlet. The tail box was design to capture all of the effluent from the flume. The tail box had 400 gallons of storage below its outlet. Effluent

water was stored in the tail box until all fine material dropped out of suspension, at which point excess water was siphoned off and the remaining solids were removed.

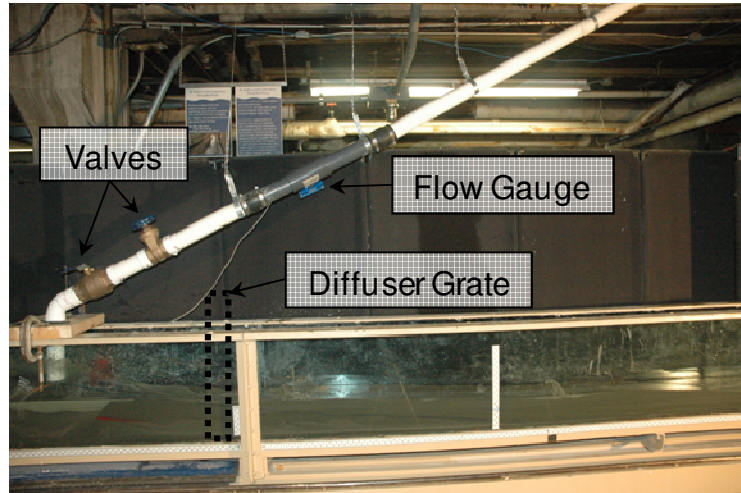

Figure 3 – Image of flume inlet.

The electromagnetic flow meter measurement was compared with that derived using a sharp crested weir placed at the downstream end of the empty flume. The flow sensor reported a discharge of 0.30 gallons/sec. The weir was 2 7/8 inches tall by 6.0 inches wide. The flow depth over the weir was 1.0 inches. Using a sharp crested weir equation, this yields a flow rate of 0.301 gallons/sec.

### 3.1.3 Phase I Experimental Procedure

Given the argument above that sediment concentration is expected to decrease down the beach, runs were conducted for a high and low solids fraction and slurry flow rates ranging from 5 to 60 GPM. Each run continued until the delta slope for that concentration and discharge was at equilibrium. One batch of slurry mix contained enough slurry for several runs. Runs were conducted in series starting with a high discharge and reducing for each consecutive run. The reducing discharge resulted in steeper slopes for each consecutive run, meaning that all runs were aggradational. This allowed the deltas from consecutive runs to be built on top of each other.

### 3.1.4 Phase I Sampling Plan

Sample locations and types are depicted in Figure 4. During the runs, grab samples were taken at the inlet and outlet of the flume. Siphon samples were also taken from the flow over the delta. Grab and siphon samples were measured for solids fraction. The upstream grab samples were used only to confirm influent solids fraction. After each run the deposit profile was measured using a point gauge. Shallow (0.4 in) scrape samples were taken from the bed. These samples were sieved to determine the grain size distribution and coarse fraction. Mini-core samples were also taken from the top 0.8 in of the bed. These samples were taken with a known volume and used to measure the porosity of the bed.



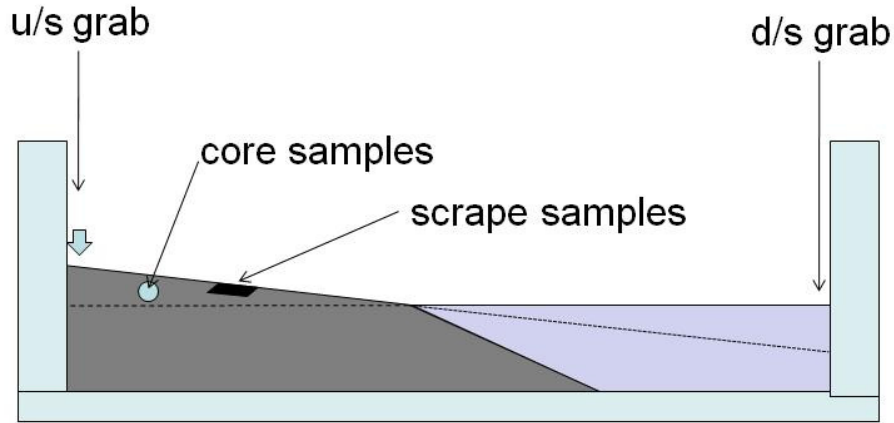

Figure 4 – Sample locations

## 3.2 Phase I Results

### 3.2.1 Qualitative Observations

Of the 16 flume runs conducted, none exhibited debris (“mud”) flow behavior. Tailings were transported by the moving water as bedload and suspended load as is typical in fluvial systems. Surface flow showed a tendency to channelize and braid, even in the relatively narrow flume. Figure 5 shows cross-flow and asymmetric bedforms within the flume. These observations indicate strongly that the field scale tailings beach will also operate in a fluvial, braided and channelized regime and addresses the first two objectives of Phase I (evaluate the potential for debris flow behavior and channelization) by ruling out concerns of more complicated non-Newtonian rheologies (i.e. mud-like behaviors) and flow.

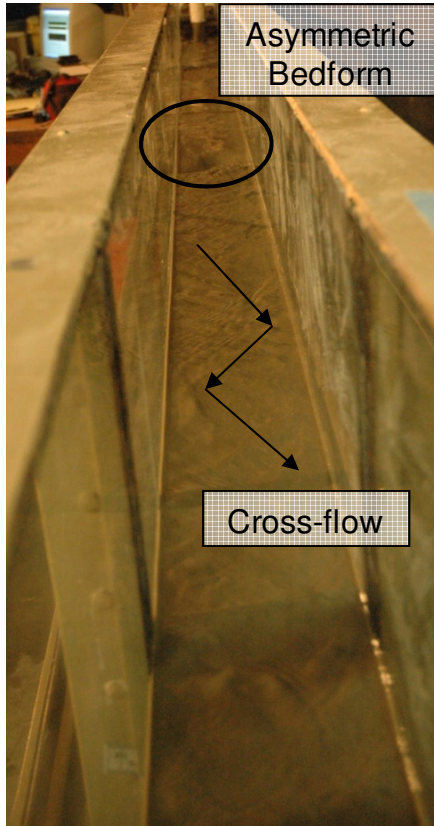

Figure 5 – Flume picture looking upstream

Nearly all runs also exhibited upstream migrating antidunes. Antidunes occur when the flow is near critical and are present in other tailings basins. They mix the upper layer of the deposit and have the potential to resuspend fine particles. A video of an upstream migrating antidune is included in Appendix D.

### 3.2.2 Slope Measurements

Final bed surface slopes were recorded after each test. Recall that each test provides a slope associated with a different position on the beach and is not by itself an actual beach profile. The run results have been binned into two categories - low and high solids fractions. Figures 6 and 7 show the bed profiles based on solids fraction. In both categories the slope decreased with increasing flow rates. The large spikes in the profiles are due to antidunes. The profiles for the higher discharge tests have more small spikes. These are due to the cross-flow (depicted in Figure 5) forming alternating dunes within the flume deposit. Figure 8 summarizes the slope results for Phase I showing deposit slopes for different discharges and solids fractions. Except very near the inlet, the beach slope should range between 0.5% and 2%.

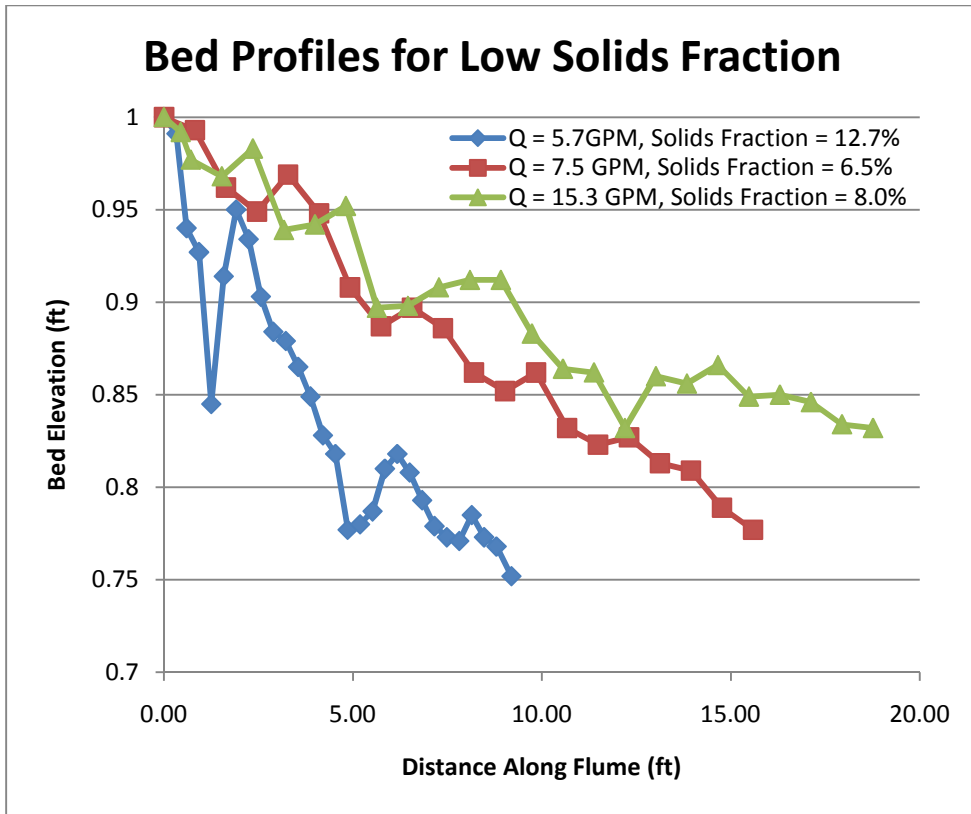

Figure 6 – Bed profiles for the low solids fraction runs

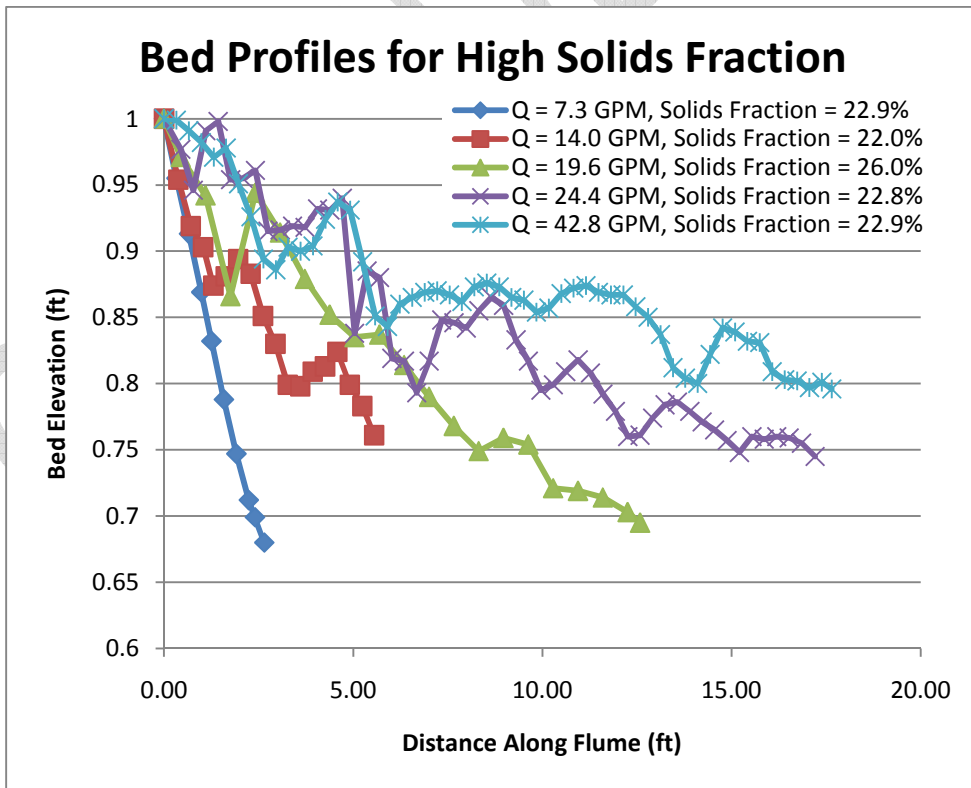

Figure 7 – Bed profiles for the high solids fraction runs

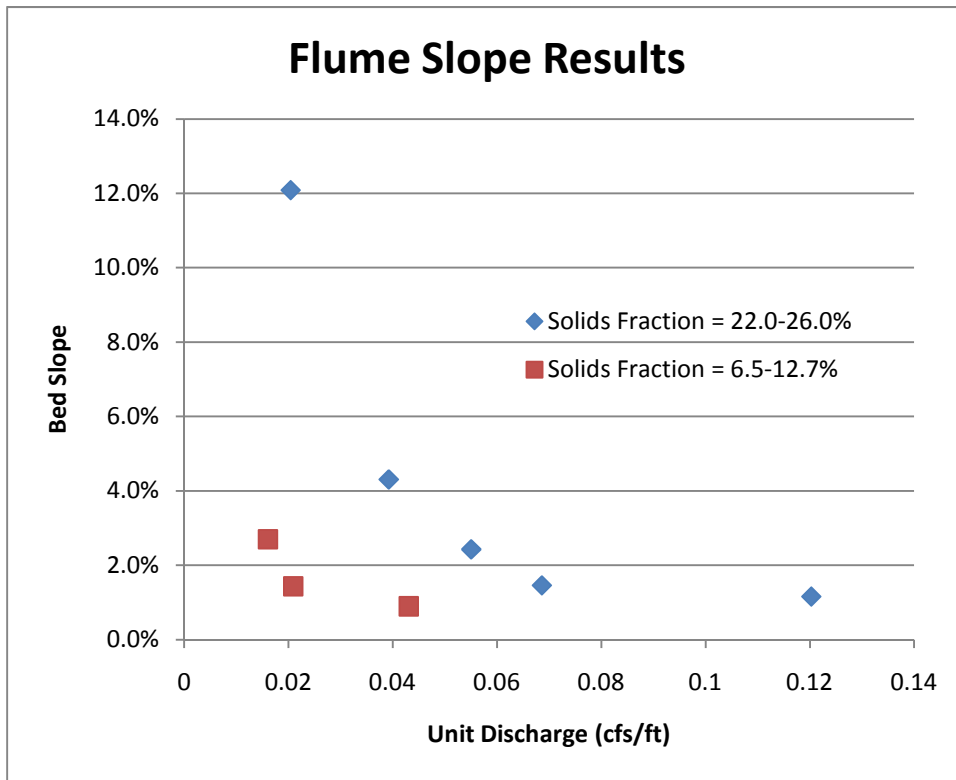

Figure 8 – Slope vs Discharge plots for high and low solids fractions.

### 3.2.3 Sediment Measurements

Downstream grab samples were taken from several of the runs. These samples were analyzed for solids fraction (Table 3). Samples taken at the downstream end of the flume consisted of suspended load only.

Table 3 – Downstream Solids Fraction

Q (GPM)	Feed Solids Fraction	Down Stream Solids Fraction
6.1	19.00%	6.30%
6.1	19.00%	7.00%
7.5	6.50%	2.70%
7.5	6.50%	3.50%
14.3	11.50%	2.90%
14.3	11.50%	3.00%
19.6	26.00%	4.30%
19.6	26.00%	6.10%

Porosity was measured at the end of four runs (Figure 9) using mini-core samples. A thin-walled, sharp-edged mini-corer was first inserted 0.8 in into the deposit. The deposit was then excavated away from around the mini-core and a blade was slid under the base of the mini-core to remove a

known volume of saturated deposit. The samples were then weighed saturated and dry to determine water weight. The water weight was then used to determine void volume and porosity. There does not appear to be a strong trend in porosity. The variability in porosity is likely driven by the localized flow phenomena occurring at the end of the test such as bedforms. The measured values for these samples were similar to the values measured for the 2D experiments (§5.3).

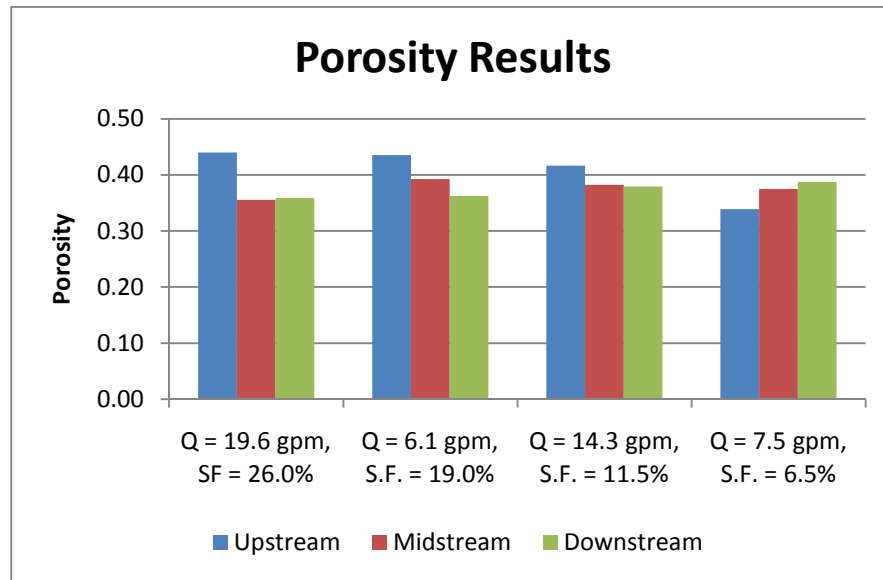

**Figure 9 – 1D Experiment Porosity Measurements**

Surface grain size was measured at various locations of the bed surface using surface scrape sampling method. The method involved sliding a blade 0.4 in below the surface to remove a 1.6 in square surface sample. Grain size distributions were measured for the 1D experiment scrape samples (Figure 10) by sieving. A comparison of the scrape samples to the fine tail of the bulk material showed that the deposit lost material in the 10 to 100 micron size range. This is the size range that remained in suspension and was transported out of the flume. Table 4 provides the coarse and fine fractions (above and below 74 microns) for the Figure 10 data. The coarse fraction is the total weight of sample retained on the 74 micron or larger sieve. The fine fraction is the total weight of sample passing the 74 micron sieve.

## Grain Size - Scrape Samples

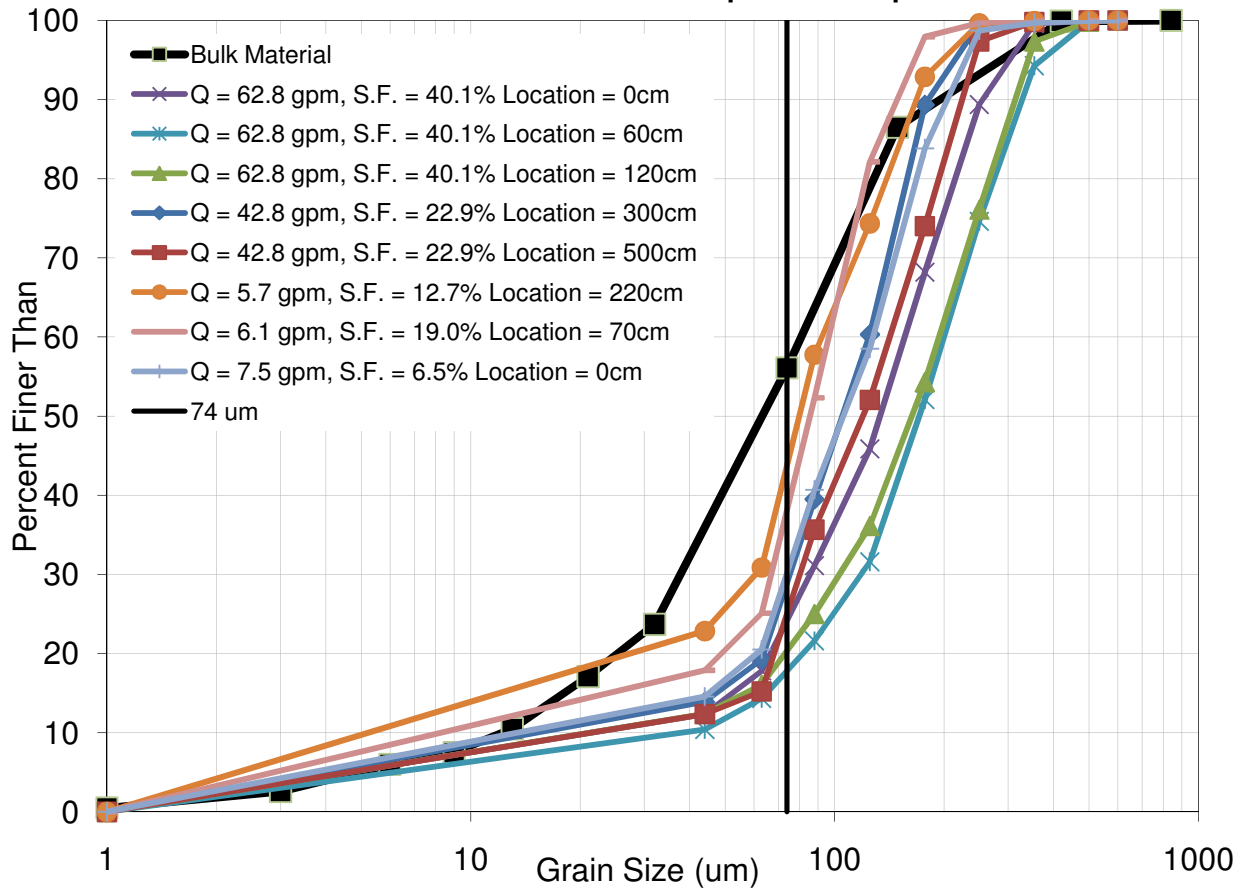

**Figure 10 – 1D Experiment Scrape Sample Grain Size Distribution**

**Table 4 – 1D Experiment Scrape Sample Coarse and Fine Fractions (by Wt)**

Discharge (GPM)	Solids Fraction	Distance from outlet	Coarse Fraction (%)	Fine Fraction (%)
62.8	40.1%	0 cm	76.3%	23.7%
62.8	40.1%	60 cm	82.5%	17.5%
62.8	40.1%	120 cm	80.0%	20.0%
42.8	22.9%	300 cm	71.8%	28.2%
42.8	22.9%	500 cm	75.8%	24.2%
5.7	12.7%	220 cm	57.3%	42.7%
6.1	19.0%	70 cm	62.9%	37.1%
7.5	6.5%	0 cm	70.6%	29.4%

### 3.3 Phase I Experiment Conclusions

Phase I experiments provided the opportunity to observe the flow characteristics of the prototype material under conditions of sediment concentration and unit discharge similar to those expected in the field. The tests indicate that the beach will not exhibit mass-flow (mud like) behavior and that the full 2D beach will be channelized, with a braided network. Bedforms and channelization will likely play a large role in the variability of fines retention, porosity, and permeability. We expect this would be true over the length of a field-scale beach as well and that the channelization will create heterogeneity that will affect the bulk permeability and conductivity of the deposit. Within the expected range of discharges and solids fractions the delta beach will have a slope between 0.5% and 2%. At high concentration near the inlet to the basin, local slopes could reach 4-6%.

The tests show that a fraction of fine material is transported beyond and not retained in the deposit. In the region of higher unit discharge near the inlet, the deposit contains a lower fraction of fine material than the near the shoreline of fan where lower unit discharge make it easier for finer grains to be deposited; however, the test data suggest that even at high discharges 15-30% (by wt) of the deposit is comprised of material sizes <74 micron.

CONFIDENTIAL

## 4.0 Phase II – 2D Basin Experiments

---

Phase II of the project focused on a two dimensional physical model of a single delta using prototype tailing to observe processes and to evaluate grain size sorting and hydraulic conductivity of the deposit. The goals of the 2D experiments were to 1) determine the expected lower limit of fines concentration in the deposit, 2) determine the degree of grain size segregation both vertically and horizontally within the deposit and 3) evaluate the potential range of hydraulic conductivity throughout the model delta.

Phase II experiments were performed as “scaled” experiments using the approach described below. Experiments were conducted in a specially designed “Delta Basin” at SAFL, which provided access to several precision data acquisition tools.

### 4.1 Scaling Approach

Phase I experiments used field-scale unit discharges and actual tailings material to investigate flow and transport processes and deposit characteristics. Given the conclusion from Phase I that the flow would be channelized on the beach top, in Phase II the goal was to employ a reduced-scale modeling approach to investigate the formation and behavior of channels on the tailings beach without lateral constraints. Again, the prototype tailings material was used.

It is obviously not feasible to conduct full scale experiments on large deltas and therefore these experiments were done at substantially reduced scale. SAFL has over 15 years of experience in physical experiments of deltaic systems and this experience was applied in this project. The scaling methods used in projects of this type differ from traditional hydraulic physical models where near-exact geometric scaling and dynamic scaling of flow is possible. The scaling approach adopted for this project sought to provide similarity in Froude number (Froude scaling), general sediment-transport regime, and the ratio between normal flow depth to radial width of the delta. This ratio is defined as the aspect ratio, A. It has been shown that the aspect ratio is a predictor of channel morphology such as braiding, meandering or straight (Parker, 1976). This work also showed that for the low aspect ratio/high slope regime expected on the tailings beach, the degree of braiding is relatively insensitive to the exact value of A as long as A is sufficiently high (a few hundred or more). To determine input parameters for the laboratory delta, we made estimates of the aspect ratio for the field scale beach and used these aspect ratios to help set discharge and concentration parameters for the lab experiments.

For the experimental design, the delta is idealized with normal, sheet flow over a 90° opening angle. This assumption means that the flow width is equal to the arc length of the delta at any radial position, yielding for the aspect ratio.

$$A = \frac{H}{L(r)} \quad (3)$$

Where:                    A = Aspect ratio

                              H = Flow depth

                              L = Arc length at a given radial position (r)



r = radial position

The first step for determining the field aspect ratio is to determine the estimated flow depth in the field. Water unit discharge along the delta is described by:

$$q_w = \frac{2Q_w}{\pi r} \quad (4)$$

Where:  $q_w$  = Water unit discharge  
 $Q_w$  = Total water discharge

Next the boundary shear stress can be derived from the normal flow assumption (Eq. 5) and by fluid drag (Eq. 6). A continuity equation relating unit discharge and flow velocity is also needed (Eq. 7).

$$\tau_b = \rho gHS \quad (5)$$

$$\tau_b = \rho U^2 C_f \quad (6)$$

$$q_w = UH \quad (7)$$

Where:  $\tau_b$  = Boundary shear stress  
 $\rho$  = Density of water  
 $g$  = Acceleration of gravity  
 $S$  = Bed slope  
 $U$  = Average flow velocity  
 $C_f$  = Coefficient of drag

Combining equations 5, 6 and 7 yields an expression for the flow depth (Eq. 8) which can be used to estimate the flow depth in the field. Equation 3 can then be used to determine the aspect ratio in the field.

$$H = \left( \frac{q_w^2 C_f}{gS} \right)^{\frac{1}{3}} \quad (8)$$

Table 5 shows the predicted flow depths and aspect ratios for the field. The same methods can be used to determine the aspect ratio for the experimental case. The aspect ratio of the experimental delta's shoreline is then used to estimate the equivalent radial position of the field scale beach.

Run 1 had a water discharge of  $4.90 \times 10^{-4} \text{ m}^3/\text{s}$  ( $1.73 \times 10^{-2}$  cfs) and a sediment discharge of  $7.35 \times 10^{-5} \text{ m}^3/\text{s}$  ( $2.60 \times 10^{-3}$  cfs), which resulted in an aspect ratio of 1500 at the shoreline ( $r \sim 1.5$  m, 5 ft). This translates to a radial position of about 40 m (130 ft) on the field delta. Run 2 had a water discharge of  $5.18 \times 10^{-4} \text{ m}^3/\text{s}$  ( $1.83 \times 10^{-2}$  cfs) and a sediment discharge of  $7.77 \times 10^{-5} \text{ m}^3/\text{s}$  ( $2.74 \times 10^{-3}$  cfs) which yields an aspect ratio of 3700 at the shoreline ( $r \sim 2.5$  m, 8.2ft). This translates to a radial position of about 70 m (230ft) on the field delta.

**Table 5 – Aspect ratios for the field delta with a water discharge of 0.80 m<sup>3</sup>/s (28.1 cfs) and a sediment discharge of 0.12 m<sup>3</sup>/s (4.3 cfs).**

<b>r (m)</b>	<b>L (m)</b>	<b>H (m)</b>	<b>A</b>
5	3.9	0.108	36
10	7.9	0.062	126
15	11.8	0.045	262
20	15.7	0.036	440
25	19.6	0.030	657
30	23.6	0.026	912
35	27.5	0.023	1204
40	31.4	0.021	1531
45	35.3	0.019	1892
50	39.3	0.017	2287
55	43.2	0.016	2715
60	47.1	0.015	3176
65	51.1	0.014	3668
70	55	0.013	4192
75	58.9	0.012	4746
80	62.8	0.012	5330
85	66.8	0.011	5945
90	70.7	0.011	6589
95	74.6	0.010	7263
100	78.5	0.0099	7965
105	82.5	0.0095	8696
110	86.4	0.0091	9456
115	90.3	0.0088	10244
120	94.2	0.0085	11059
125	98.2	0.0082	11902
130	102.1	0.0080	12773
135	106	0.0078	13671
140	110	0.0075	14596
145	113.9	0.0073	15547
150	117.8	0.0071	16526

## 4.2 Experimental Setup

The facility used in Phase II was an existing delta basin at SAFL (Figure 1). The delta basin is square, 5 m (16.4ft) on a side, and 40 cm (1.3ft) deep. Water and sediment were fed into one corner of the basin at a constant rate for each experiment. Prototype tailings were used as the sediment for the tests and were provided by the sponsor. Dry tailings material was fed using an auger-style sediment feeder and feeder discharge was calibrated using a capture and weigh technique.

City water was used for all experiments and the water feed rate was controlled by a gate valve and a rotameter flow meter. The water and sediment were allowed to mix in a funnel before discharging into the basin. The pool elevation in the model tailings basin was set by a computer-controlled siphon and weir that were adjusted at one-minute intervals and provided precise control of the water surface elevation throughout each experiment.

Prior to beginning the tests a drainage layer was placed in the basin that was composed of fine to medium sand. The depth of the drainage layer was 3 cm (1in) and it extended radially out from the source for 3m (10ft). This layer is typically installed in all SAFL experimental deltas to promote dewatering of the deposit post-run and to shorten drying time required before the deposit can be sectioned.

The basin was equipped with a data collection carriage including a laser scanner that can measure topography accurate to 0.5 mm vertically. The carriage was used to map surface topography throughout the testing. A digital SLR camera, mounted above the basin, was calibrated for optical distortion and used to collect time-lapse images of the delta formation and surface processes.

### 4.3 Experimental Procedure

Two deltas were constructed in Phase II (Run 1 and Run 2). Each delta was constructed in three phases. The first phase (growth phase) modeled the initial formation of a delta into a sediment free basin with a stationary pool elevation of 30 mm (1.2in) (Figure 11). During this phase the delta grew out to a radius of approximately 1.5 meters (5ft). The second phase (building phase) involved slowly raising the pool elevation such that the shoreline position was constant (Figure 12). This continued until the delta thickness increased by a total of 10 cm (4in). The third phase involved a slow decrease in pool elevation in order to promote delivery of tailing to the shoreline position and to minimize deposition on the fan surface except for the coarsest material (Figure 13). The third phase (falling phase) of each experiment was designed to generate the coarsest possible deposit, with the strongest lateral segregation of material possible. The goal was to understand how coarse and permeable the delta deposit could be for a “worst case” transport scenario. Analysis of the third phase deposit provides a reference case for permeability and other characteristics of a deposit created under the most extreme conditions of sorting and coarse-sediment retention.

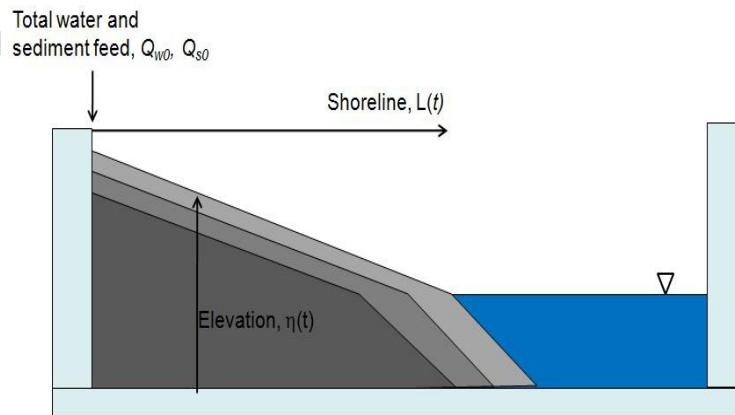

Figure 11- Delta growth with constant pool elevation

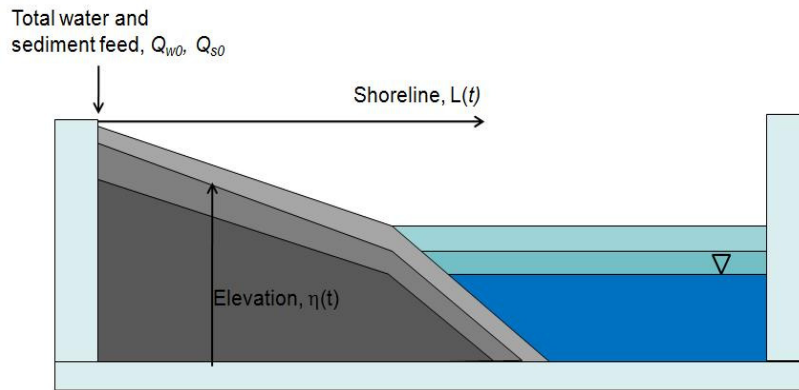

Figure 12 – Delta growth with fixed shoreline by balanced pool rise

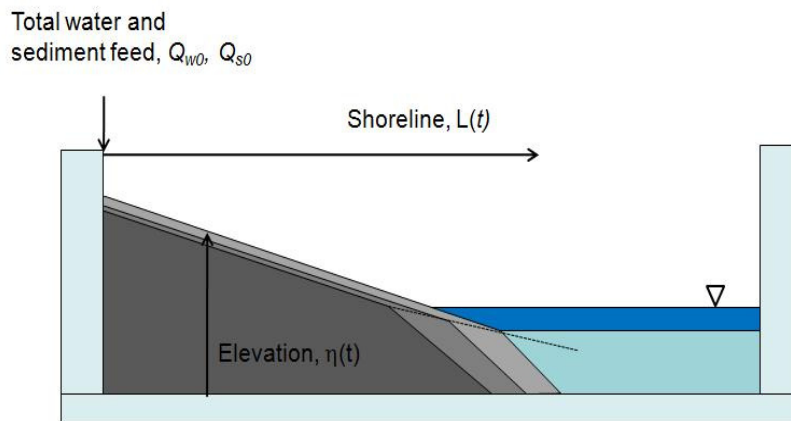

Figure 13 – Delta growth with falling pool elevation

Using the scaling approach described above, for Run 1 the water discharge was set at 0.49 liters/second (0.017 cfs). Sediment concentration was set equal to prototype design conditions giving a sediment supply rate of 0.074 liters/second (0.0026 cfs). For Run 2 the water discharge was set at 0.51 liters/second (0.018cfs) and sediment discharge at 0.078 liters/second (0.0028cfs).

## 4.4 Phase II Data Collection

### *Topographic Scans*

A three axis data carriage was used to scan the surface of the subaerial deposit at the end of each pool control phase (growth, building and falling). Data are collected with a laser-based distance meter accurate to 0.5mm vertically. Scans were done on a 2mm x 2mm horizontal grid. Data were post processed and are presented later in the report.

### *Pool and Scrape Samples*

Forty-five scrape samples were taken along 5 radial lines. Scrape samples covered approximately 10 cm<sup>2</sup> (1.5 in<sup>2</sup>) of the surface and 1 cm (0.4 in) of depth (Figure 14). Three scrape samples were

taken from the bottom set (bottom of the pool downstream of delta) of the delta deposit for grain size analysis.

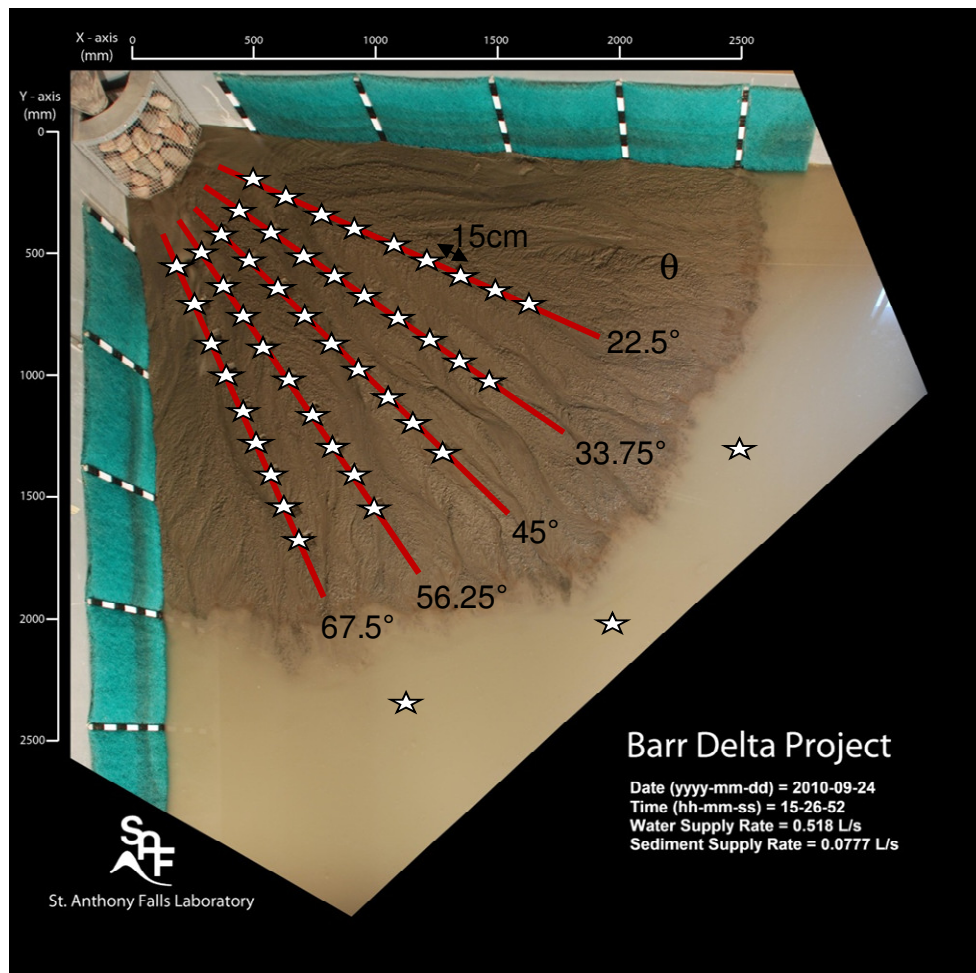

Figure 14 – Scrape sample locations

### **Digital Photographs**

A digital SLR camera mounted above the basin and connected to a computer allowed continuous time-lapse documentation of the delta surface. Images were collected at a rate of 3 per minute. Images were post processed to correct for distortion.

### **Porosity Mini-Cores**

At the end of each run, 6 mini-cores (2 cm, 0.75in deep) were taken to determine the porosity of the surface layer. A thin-walled, sharp-edged mini-core was first inserted 2 cm (0.75in) into the deposit. The deposit was then excavated away from around the mini-core and a blade was slid under the base of the mini-core to remove a known volume of saturated deposit. The samples were then weighed saturated and dry to determine water weight. The water weight was then used to determine void volume and porosity. Of these 6 mini-cores, three were taken at the upstream end of the delta – one each in the main channel, an old channel, and out of the channel. The other three were taken in the same locations at the downstream end of the deposit.

### ***Freeze Slices***

To record deposit structure, a 20-inch wide steel wedge with a vertical face on the upstream edge was inserted into the saturated deposit (Figure 15). The wedge was filled with dry ice and methanol. The two substances react to rapidly freeze the surrounding one-half inch of sediment to the wedge. When the wedge is removed, the frozen sediment is removed with it. The wedge is then filled with room temperature water. This delaminates the freeze slice from the working face of the wedge. At this stage the working face of the frozen sediment slice has residual ice buildup due to contact with the freeze core. To remove imperfections due to ice buildup, the working face is heated with a heat gun. This leaves one-eighth inch of slurry on top of three-eighths inch frozen sediment slice. The slurry is removed with a blade and the surface is brushed with a feather duster to remove any displaced particles from the blade. The remaining frozen slice of sediment preserves the delta stratigraphy and is ready to be photographed. For Run 2 two freeze slices were taken transverse to flow at 55 cm (1.8ft) and 150 cm (5ft) downstream of the feed point. These slices were photographed and subsampled for grain size analysis.

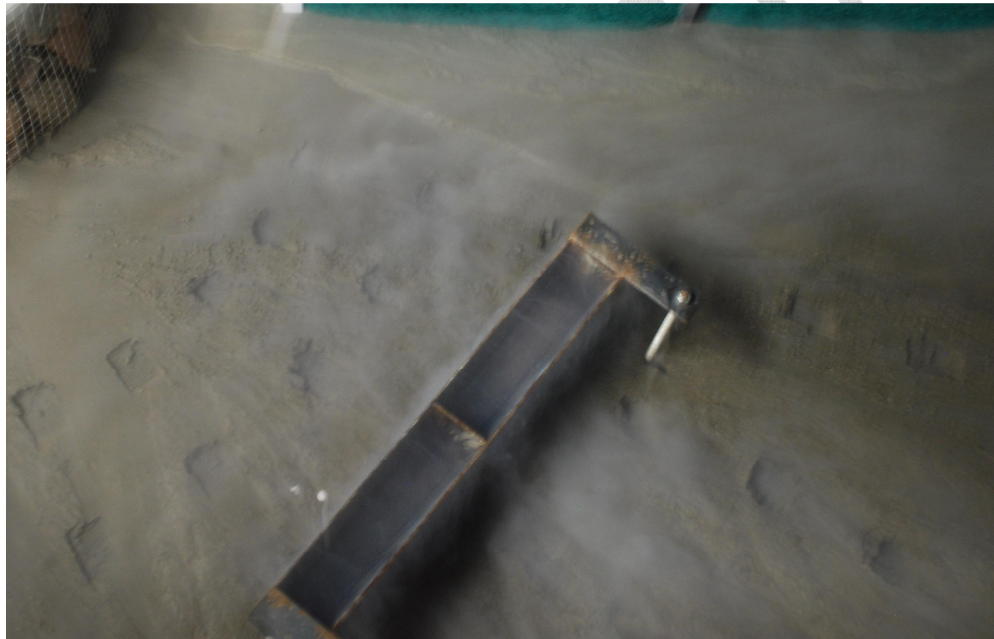

**Figure 15a – Freeze slice apparatus.**

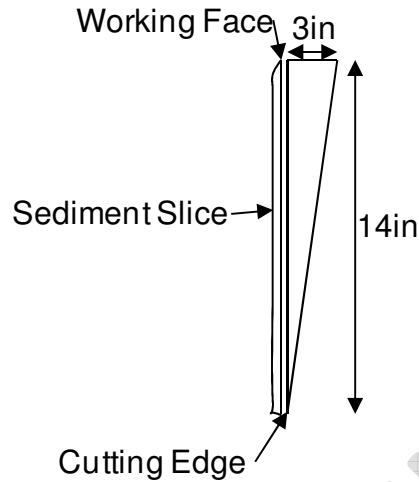

Figure 15b – Freeze Slice apparatus

### **Hydraulic conductivity samples**

For Run 1 twenty full-depth piston cores were also taken along 3 radial lines within the beach. The hydraulic conductivity was tested on the cores using a rigid-walled, falling-head analysis. The benefit of this method is that the core cylinders can be inserted directly into the test apparatus without transferring the samples. Additionally, the percentage of fines in these samples exceeded the limits for the traditional constant head tests, and the hydraulic conductivities also exceed the limits for the traditional flexible-walled permeameter tests.

The test equations (Eq. 9 & 10) for the rigid-walled, falling head analysis are the same as for the flexible-walled permeameter.

$$k = \frac{aL}{At} \ln \left( \frac{h_1}{h_2} \right) \quad (9)$$

$$\kappa = k \frac{\mu}{\rho g} \quad (10)$$

Where:

- k = Hydraulic conductivity
- $\kappa$  = Permeability
- a = Standpipe cross-sectional area
- A = Soil sample cross-sectional area
- L = Soil sample length
- $h_1$  = Water head at start of the test
- $h_2$  = Water head at end of the test
- t = Total test time
- $\mu$  = Water viscosity
- $\rho$  = Water density
- g = Acceleration of gravity

***Other sediment sampling***

During operation, samples of the pool water were taken for grain size analysis. The grain size analysis was performed using Horiba® laser diffraction. Laser diffraction was chosen in cases where sample volumes were too small for sieving or hydrometer tests.

CONFIDENTIAL



## 5.0 Phase II – Results

---

The Run 1 delta had a 2 m (6.5ft) radius and was approximately 20 cm (8in) thick. The radius of the Run 2 delta was 2.5 m (8.2ft) and approximately 15 cm (6in) thick. 20-second timelapse videos of the evolution of each of the runs are provided in Appendix D. The data acquired from Runs 1 and 2 are described below.

### 5.1 Pool and Scrape Sample Particle Size Analysis

#### 5.1.1 Sieve Analysis of Scrape Samples

##### 5.1.1.1 Run 1 Scrape Samples

The bulk material from Run 1 (preliminary grind) had a coarse fraction of about 41%. The coarse fraction is defined as the fraction of material by weight retained on a 74 micron sieve. 82% of the scrape samples taken from the beach had a coarse fraction of greater than 41%. The higher coarse fraction indicates that a portion of the fines bypassed the beach deposit and were flushed into the pool.

Figure 16a is an aerial photo of the Run 1 delta at the end of the growth phase. Figure 16b is the coarse fraction results from the scrape samples taken at that time across each radial sampling line and at various radii across the basin. The key indicates the location of the radial line relative to the left wall of the basin (looking downstream) and listed in radians and equivalent to 22.5, 33.75, 45, 56.25, and 67.5 degrees, respectively (Figure 14). Appendix B contains tabular results of the grain size analyses from all the scrape samples. Note in Figure 16b that the coarse fraction peaks at a radius of 55 cm. Figure 16a shows that the coarse peak at 55 cm is the same location as the flow transition from sheet flow to channelized flow. The general downward trend after the 55 cm radius confirms that the relative quantity of fines in the deposit increases with distance from the source. The variability in coarse fraction observed for the five radial transects are likely due to the chaotic nature of the braided system which means the delta surface includes a range of geomorphic features such as in-channel, channel bank, and floodplain. Similar evidence for local grain segregation was observed in other data: light and dark lenses observed in the suction cores and freeze slices taken from the final deposit(s) (See §5.4).

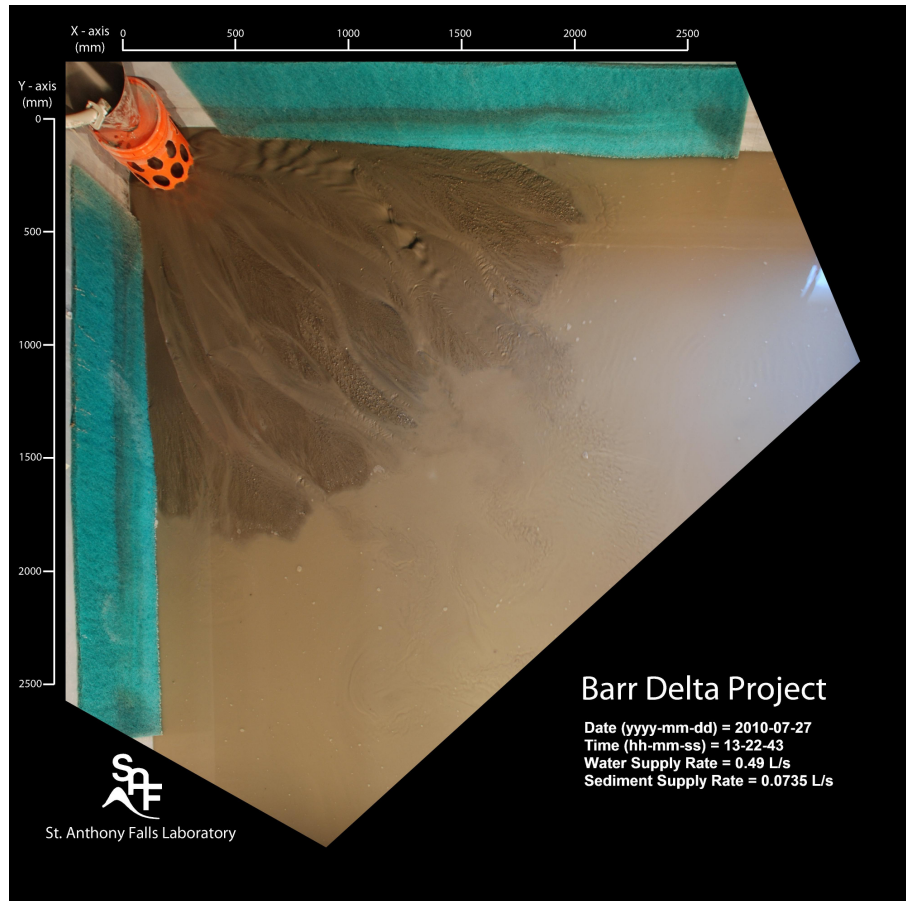

Figure 16a – Run 1 aerial photo of at the end of the growth phase.

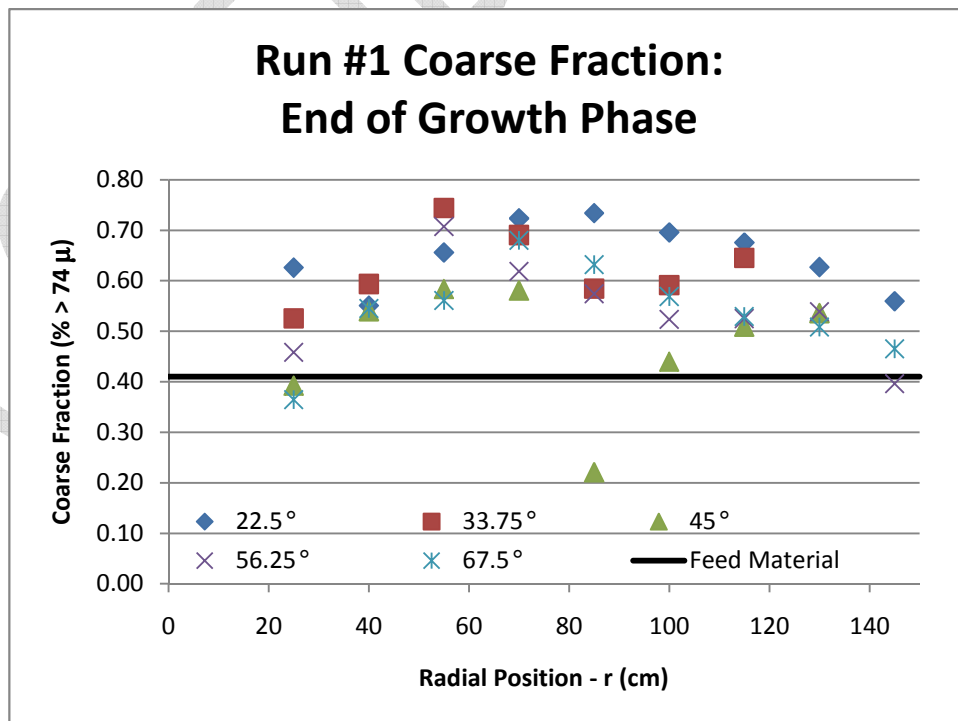

Figure 16b – Run 1 coarse fraction plot at the end of the growth phase.

Figure 16c is an aerial photo taken during Run 1 at the end of the falling phase (i.e. the final deposit), and Figure 16d is the results of the scrape samples taken at that time. Recall that during this falling phase the pool level was slowly lowered with the intent of promoting bypass of fine and preferential deposition of coarse material. In Run 1, a distinct single channel formed in the deposit at approximately the position of radial line at  $\theta = 67.5^\circ$  and this channel remained for most of the phase. All other radial lines for scrape samples were located in overbank settings. The data in Figure 16 may help to distinguish grain size distribution typical of in-channel versus overbank settings. The upper limit of the coarse fraction is reflected in the 5 scrape samples along the radial line at  $\theta = 67.5^\circ$  that were taken from the main channel and range from 70-75%. The other samples taken from the floodplain range from 40-60% coarse material. These samples also show a slight downward trend indicative of downstream fining. Figure 16e compares the scrape results from each phase of Run 1. In general all samples were coarser than the input mixture indicating some loss of fine material. An upper limit is observed however as no deposit was coarser than 75% coarse sediments- even within an active channel.

After Run 1 was complete, the basin was slowly drained over a 25-day period of time. Three scrape samples were then taken from the bottomset, the subaqueous deposit on the sea floor less than 10cm (4in) beyond the delta toe. When sieved, 100% of each of these samples was less than 74 microns in diameter. These samples were saved for laser diffraction grain size analysis (§ 5.1.2). These results are expected since the bottomset is submerged by the pool, and the bottomset material is deposited via settling.

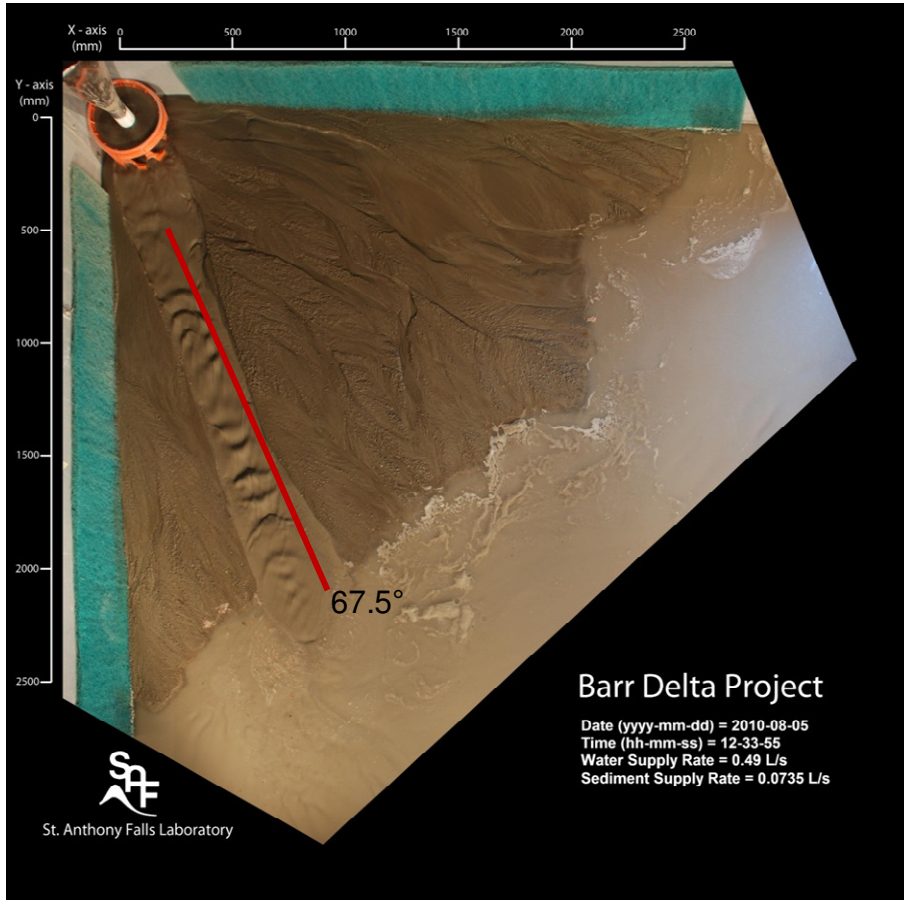

Figure 16c – Run 1 aerial photo of at the end of the falling phase.

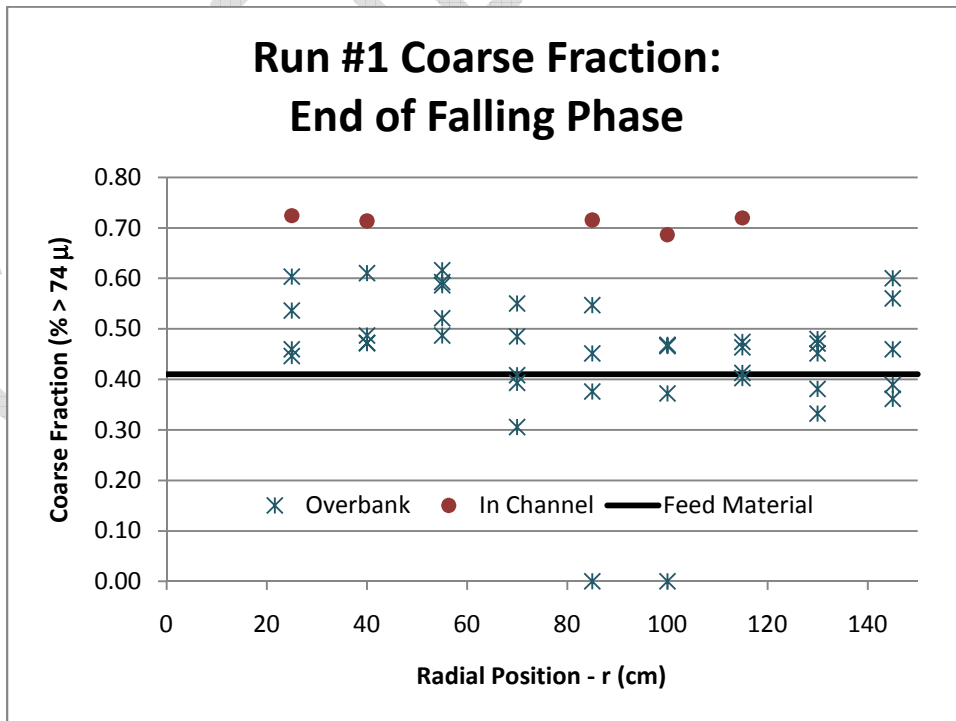

Figure 16d – Run 1 coarse fraction plot at the end of the falling phase.

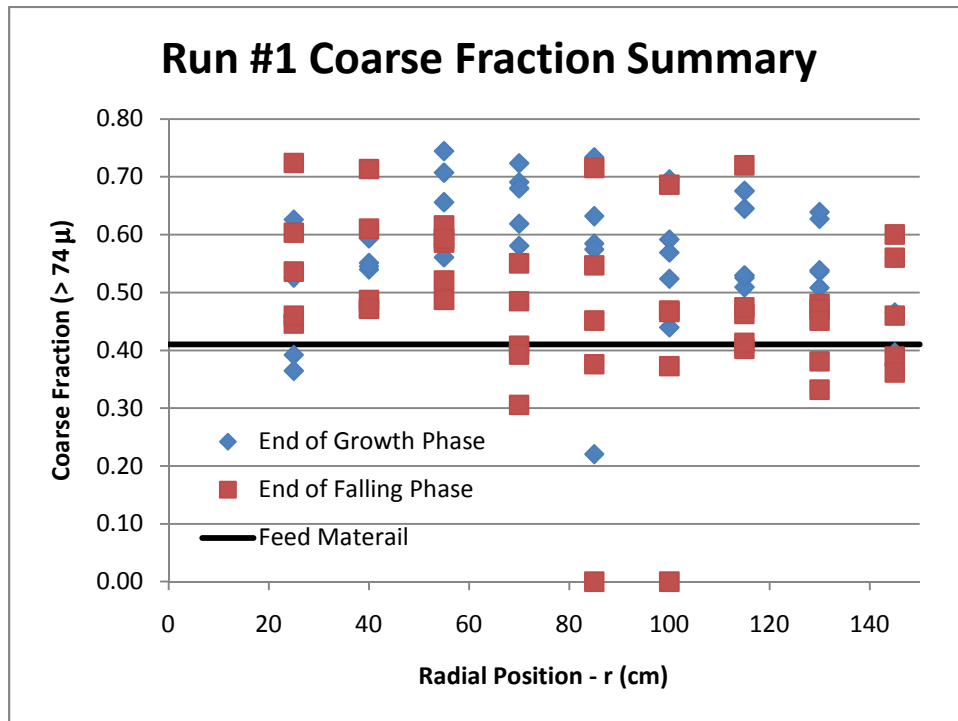

Figure 16e – Run 1 coarse fraction plot for all phases.

### 5.1.1.2 Run 2 Scrape Samples

The bulk material from Run 2 (final grind) also has a coarse fraction of about 41%. The higher coarse fractions found in 68% of the scrape samples indicate that a portion of the fines bypassed the beach deposit and were flushed into the pool. Figures 17a and 17b are the overhead photo and scrape sample results from the end of the growth phase. Like Run 1, there is a general downward trend in the coarse fraction indicative of downstream fining. The  $\theta = 33.75^\circ$  radial line sample does jump at the downstream end of the beach. This sample location was partially submerged by the pool which causes settling of coarse material.

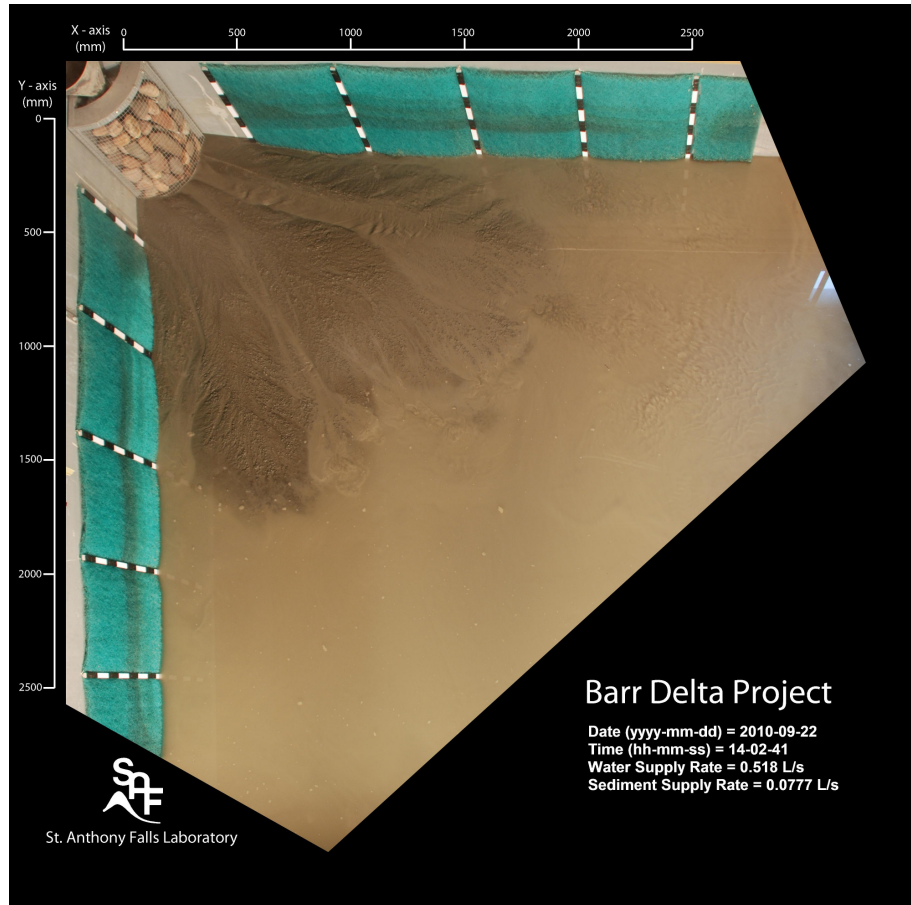

Figure 17a – Run 2 aerial photo of at the end of the growth phase.

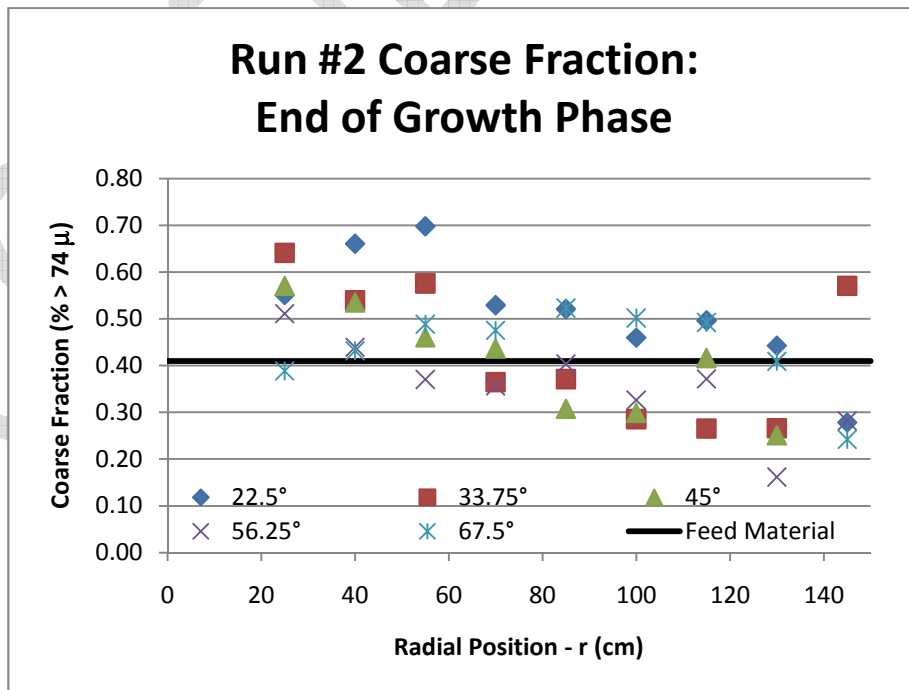

Figure 17b – Run 2 coarse fraction plot at the end of the growth phase.

Figure 17c is the overhead photo taken at the end of the building phase. The coarse fraction plot for the building phase is shown in Figure 17c. The results are similar to previously shown data where there is general fining of the deposit down slope and a variability in coarse fraction that ranges from 40% to 65%. The variability in the coarse fraction is largely due to the influence of bedforms and the braided channel morphology on the deposit. The image in Figure 17c highlights the chaotic nature of the fan surface with multiple braided channels and anti-dune bedforms (highlighted).

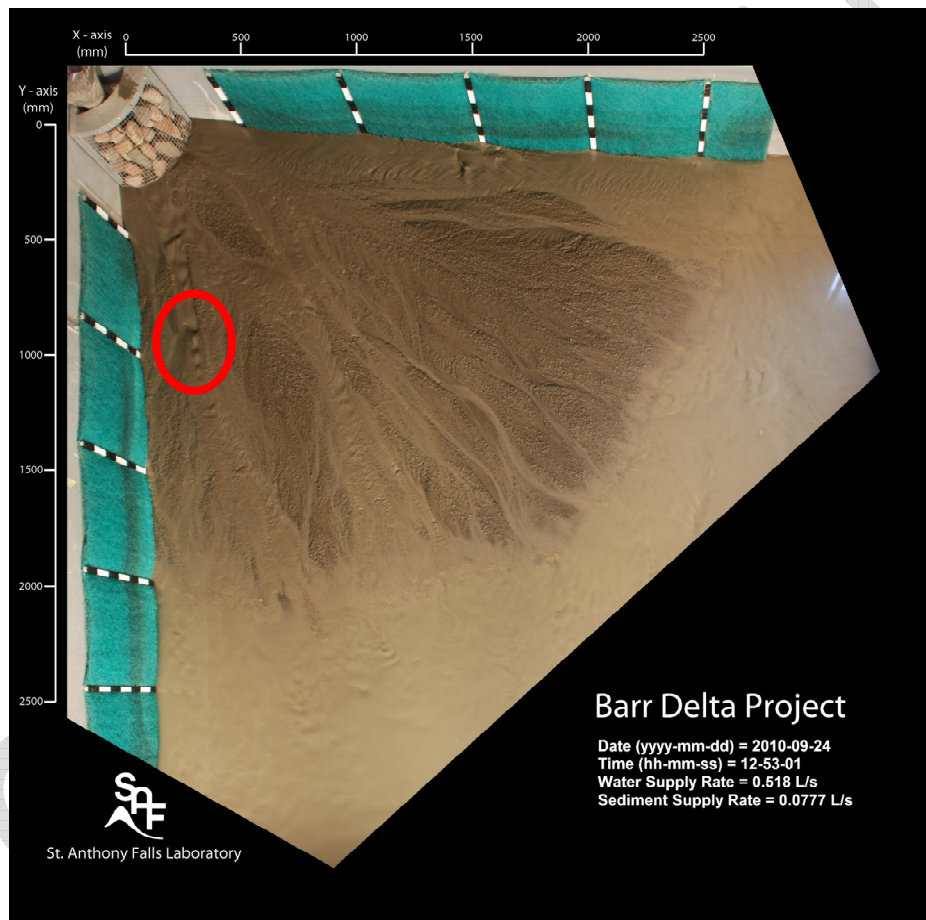

Figure 17c – Run 2 aerial photo of at the end of the building phase.

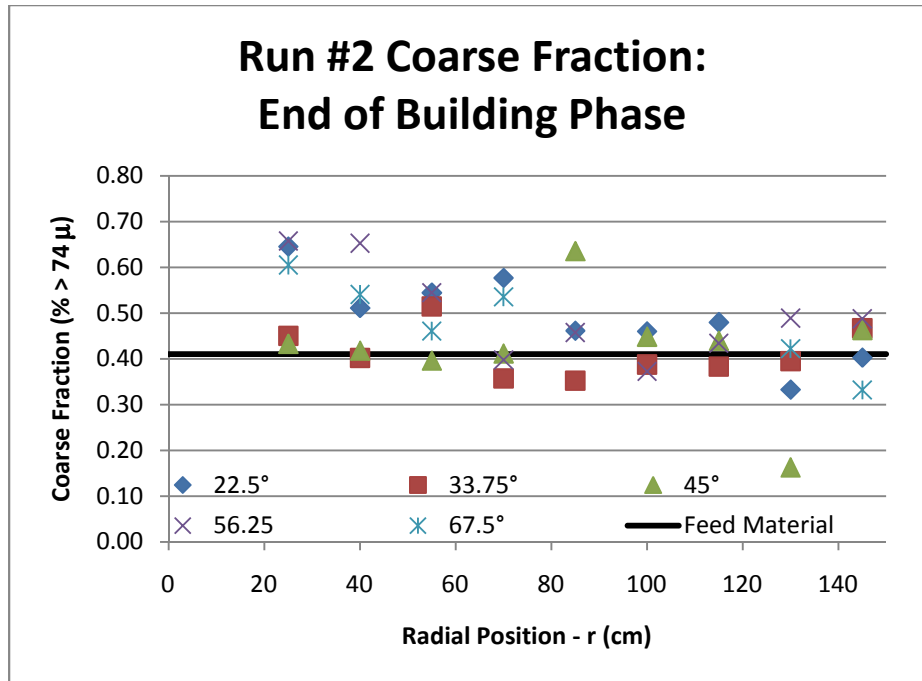

Figure 17d – Run 2 coarse fraction plot at the end of the building phase.

Figures 17e and 17f are the aerial photo and coarse fraction plot for the end of the falling phase. The photo highlights the anti-dune formations prevalent in the main channel. Figure 17g shows that the falling phase is generally the coarsest phase of Run 2, and the results from Figure 17f should be considered the worst case scenario for fines retention.



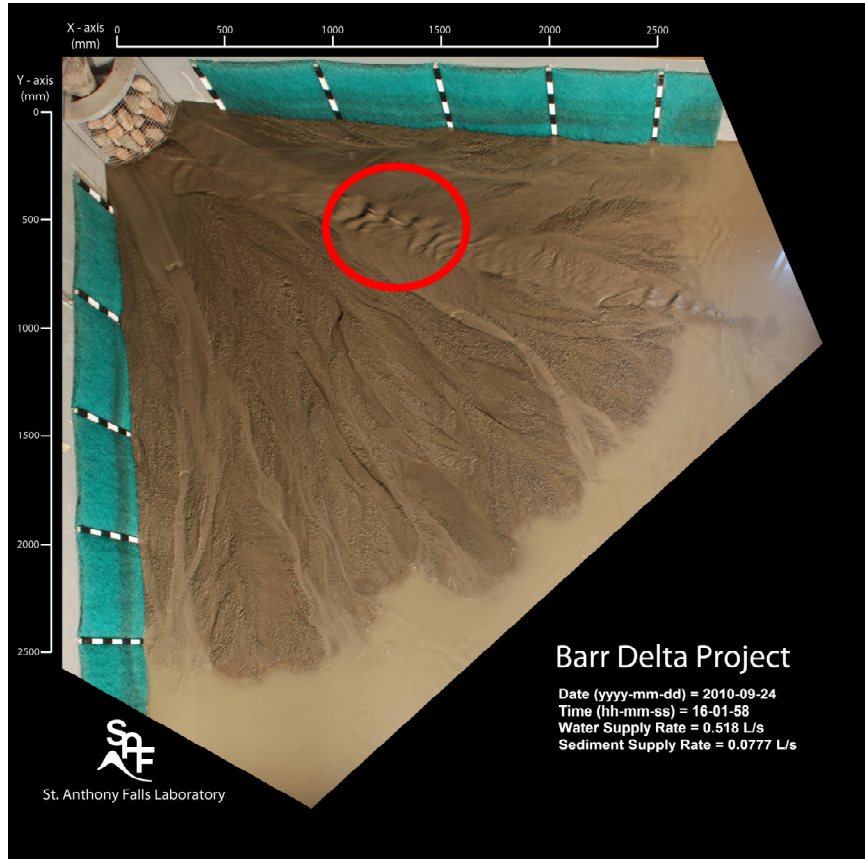

Figure 17e – Run 2 aerial photo of at the end of the falling phase.

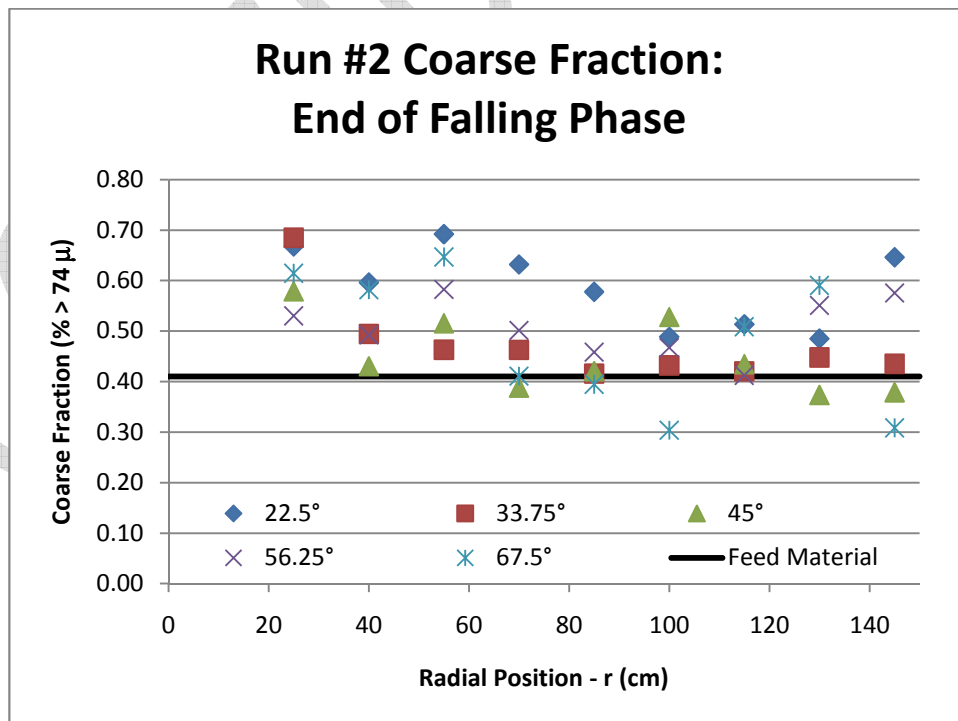
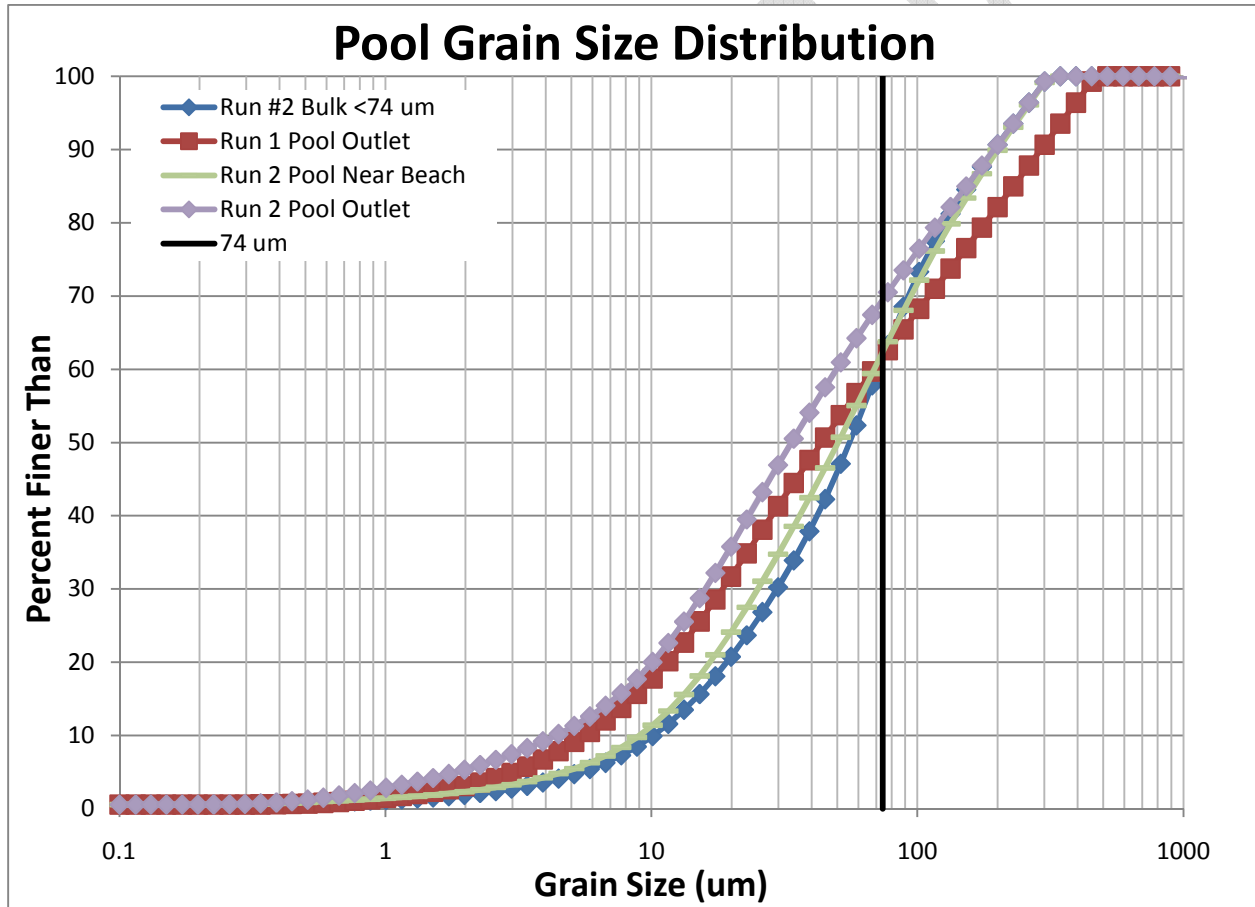

Figure 17f – Run 2 coarse fraction plot at the end of the falling phase.



**Table 6 – Solids fractions measured in pool samples**

Run	Sample	Sample Location	% Solids	Concentration (kg/m <sup>3</sup> )
1	1	At basin outlet	0.12%	1.2
1	2	At basin outlet	0.17%	1.7
2	2	Away from outlet	0.06%	0.6
2	4	Near shoreline	1.62%	15.9
2	6	At basin outlet	0.16%	1.6



**Figure 18 – Grain size distribution from pool sample.**

Three bottomset scrape samples were taken from each final deposit. The grain size distributions provided in Figure 19 show that the bottomset particles fall within the fine fraction. The Run 1 bottomset scrape samples were taken within 10 cm (4in) of the toe of the deposit. The Run 2 bottomset scrape samples were taken about 30 cm (1ft) from the deposit toe. The coarser range of bottomset particles for Run 1 may be attributed to more settling near the toe. Figure 19 shows

that the Run 2 bottomset has fewer 1-74 micron size particles than the fine fraction of the bulk material. These missing particles were most likely trapped within the delta deposit.

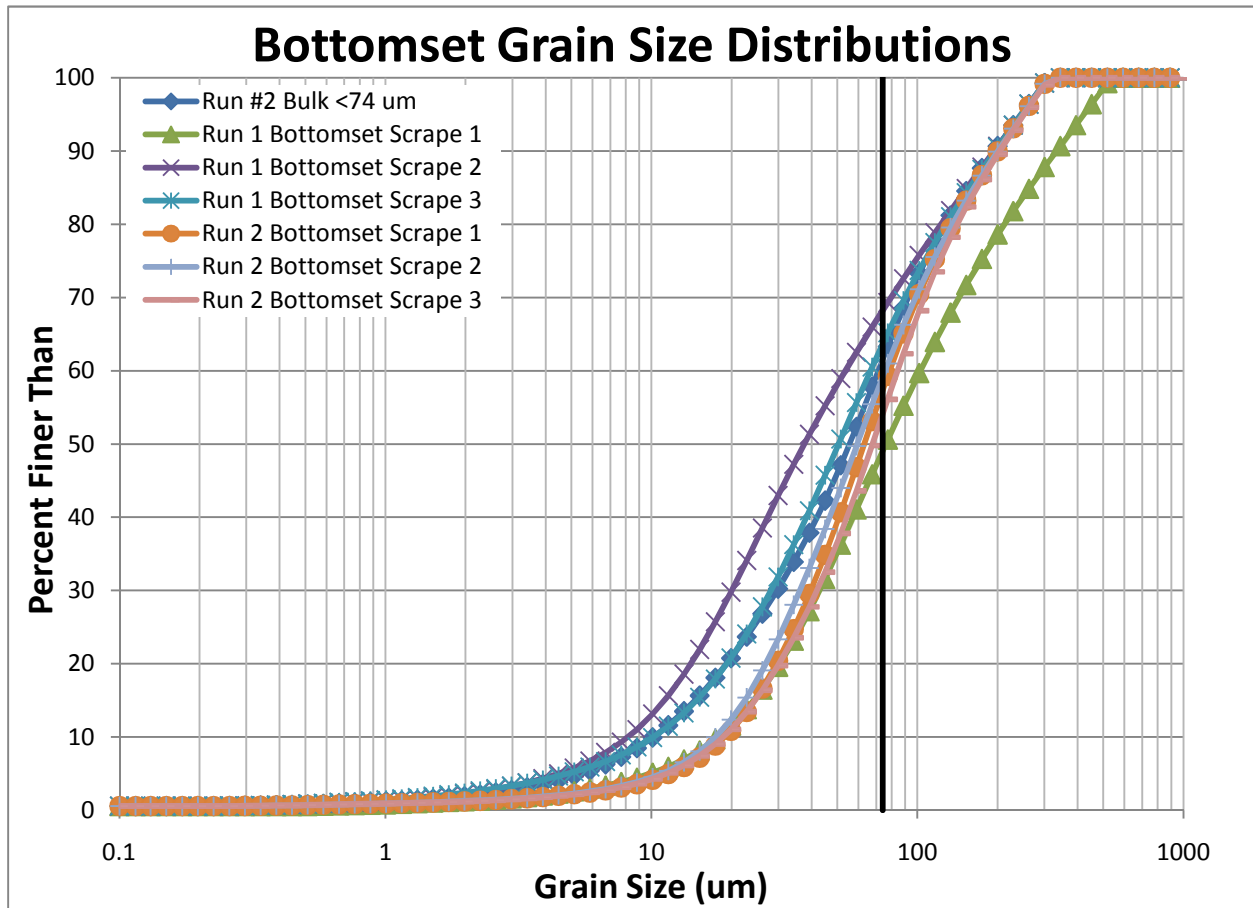

Figure 19 – Bottomset Scrape Sample Grain Size Distributions Measured Using Horiba® Laser Diffraction

## 5.2 Hydraulic Conductivity

Table 7 lists the results from the hydraulic conductivity tests. The data show that the hydraulic conductivity throughout the Run 1 deposit was quite low, although the values from various cores range over nearly one order of magnitude from  $1.7 \times 10^{-6}$  to  $1.3 \times 10^{-5}$  m/s. It is important to note that light and dark lenses were observed within the cores (§ 5.4.1) and that these lenses represent bodies of distinct grain size or fines content. The hydraulic conductivity test performed on the cores forces the vertically flowing water to pass through all elements of the deposit stratigraphy. Fine lenses are limiting layers which reduce the measured hydraulic conductivity. In the unconfined delta it is possible that the groundwater will simply flow around the fine lenses, depending on how the lenses are connected spatially. This would result in higher groundwater transport rates than are reflected by the hydraulic conductivity test. Section 5.4.2 has discussion of the connectivity of the fine and coarse lenses. Subject to this caveat about the possibility of bypassing the fine lenses, the trends of the measurements are descriptive of the sorting properties within the delta. The results, plotted in Figure 20, clearly show that vertical hydraulic conductivity changes with position in the delta. The primary factors influencing permeability are the  $D_{50}$  grain size and the degree of sorting (Beard and Weyl 1973). The decreasing trend shown

in Figure 20 is likely a result of the increasing fraction of fines with radial position (i.e. downstream fining). This is the expected trend in depositional fans and thus would be predicted for the field case as well.

**Table 7 – Run 1 results of falling head hydraulic conductivity tests**

Sample #	r (cm)	L (cm)	h <sub>1</sub> (cm)	h <sub>2</sub> (cm)	t (sec)	k (m/sec)	k (cm/sec)	k (ft/min)	κ* (Darcy)
1	30	27	230	159.5	6723	1.0E-05	1.0E-03	2.1E-03	1.08
2	60	23.4	225.6	167.9	5269	9.3E-06	9.3E-04	1.8E-03	0.96
3	90	21.8	227.6	138	8093	9.6E-06	9.6E-04	1.9E-03	0.49
4	120	21.3	228.2	142.3	12360	5.8E-06	5.8E-04	1.1E-03	0.99
5	150	19.7	210.1	161.9	9850	3.7E-06	3.7E-04	7.3E-04	1.35
6	180	19.3	226.8	191.8	8393	2.7E-06	2.7E-04	5.4E-04	0.48
7	210	17.5	229.4	169.7	7956	4.7E-06	4.7E-04	9.3E-04	1.23
8	30	24.5	228.7	138.6	6695	1.3E-05	1.3E-03	2.6E-03	0.36
9	60	23.5	226.3	146.5	8400	8.6E-06	8.6E-04	1.7E-03	0.28
10	90	23	227	170.2	9047	5.2E-06	5.2E-04	1.0E-03	0.89
11	120	21	222.9	158.7	8892	5.7E-06	5.7E-04	1.1E-03	0.18
12	150	19.8	227.1	166.5	8887	4.9E-06	4.9E-04	9.7E-04	0.54
13	180	17.8	229.9	202.8	9110	1.7E-06	1.7E-04	3.4E-04	0.60
14	210	19	221.6	175.7	6817	4.6E-06	4.6E-04	9.0E-04	0.46
15	30	24.6	226.2	149.6	6071	1.2E-05	1.2E-03	2.3E-03	0.51
16	60	23.3	225.5	145.9	11128	6.5E-06	6.5E-04	1.3E-03	0.59
17	90	22.2	226.7	147.3	9779	6.9E-06	6.9E-04	1.4E-03	0.28
18	120	20.2	227.3	154.4	12428	4.5E-06	4.5E-04	8.8E-04	0.67
19	150	19.6	229.2	184.7	11241	2.7E-06	2.7E-04	5.3E-04	0.72
20	180	18	227.1	193.2	5958	3.5E-06	3.5E-04	6.8E-04	0.38

\* Note: κ is permeability, 1 Darcy = 9.869×10<sup>-13</sup> m<sup>2</sup> = 1.062×10<sup>-11</sup> ft<sup>2</sup>

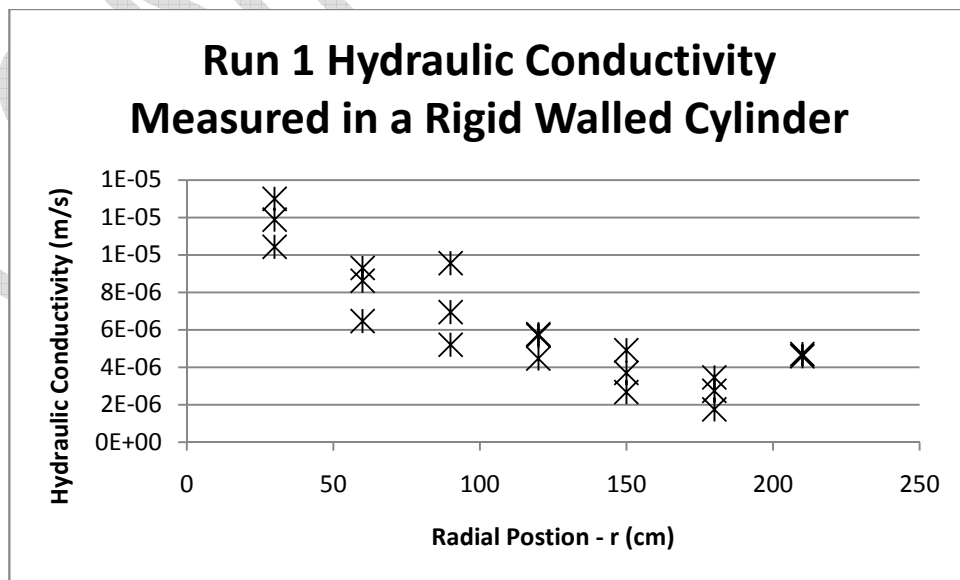

**Figure 20 – Run 1 hydraulic conductivity variation with radial position along delta.**

## 5.3 Porosity

The porosity of the Run 1 delta was measured using two methods. The first was mini-cores that measure porosity in the top 2 cm (0.75in) of the final delta surface. The second method is the bulk porosity measured from the full depth piston cores.

Table 8 lists the results from the surface porosity measurements. There is some variability at the different locations; however, there is no indication of spatial trends. Table 9 lists the bulk porosity from the Run 1 core samples.

**Table 8 – Run 1 surface porosity taken via mini-cores**

<b>Sample Location</b>	<b>Porosity</b>
Upstream in Main Channel	0.42
Upstream in Secondary Channel	0.37
Upstream out of Channel	0.37
Downstream in Main Channel	0.35
Downstream in Secondary Channel	0.42
Downstream out of Channel	0.42

**Table 9 – Run 1 bulk porosity taken from suction cores.**

<b>Core #</b>	<b>r (cm)</b>	<b>Porosity</b>
3	90	0.43
4	120	0.43
12	150	0.43

## 5.4 Stratigraphy

### 5.4.1 Suction Cores

After the Run 1 piston cores were tested for hydraulic conductivity, the four samples were extruded from the cylinder and split open for imaging. Figures 21a – 21d show images of the split cores. These images show light and dark bands within the deposit. Different color bands are associated with different grain sizes or sorting properties.

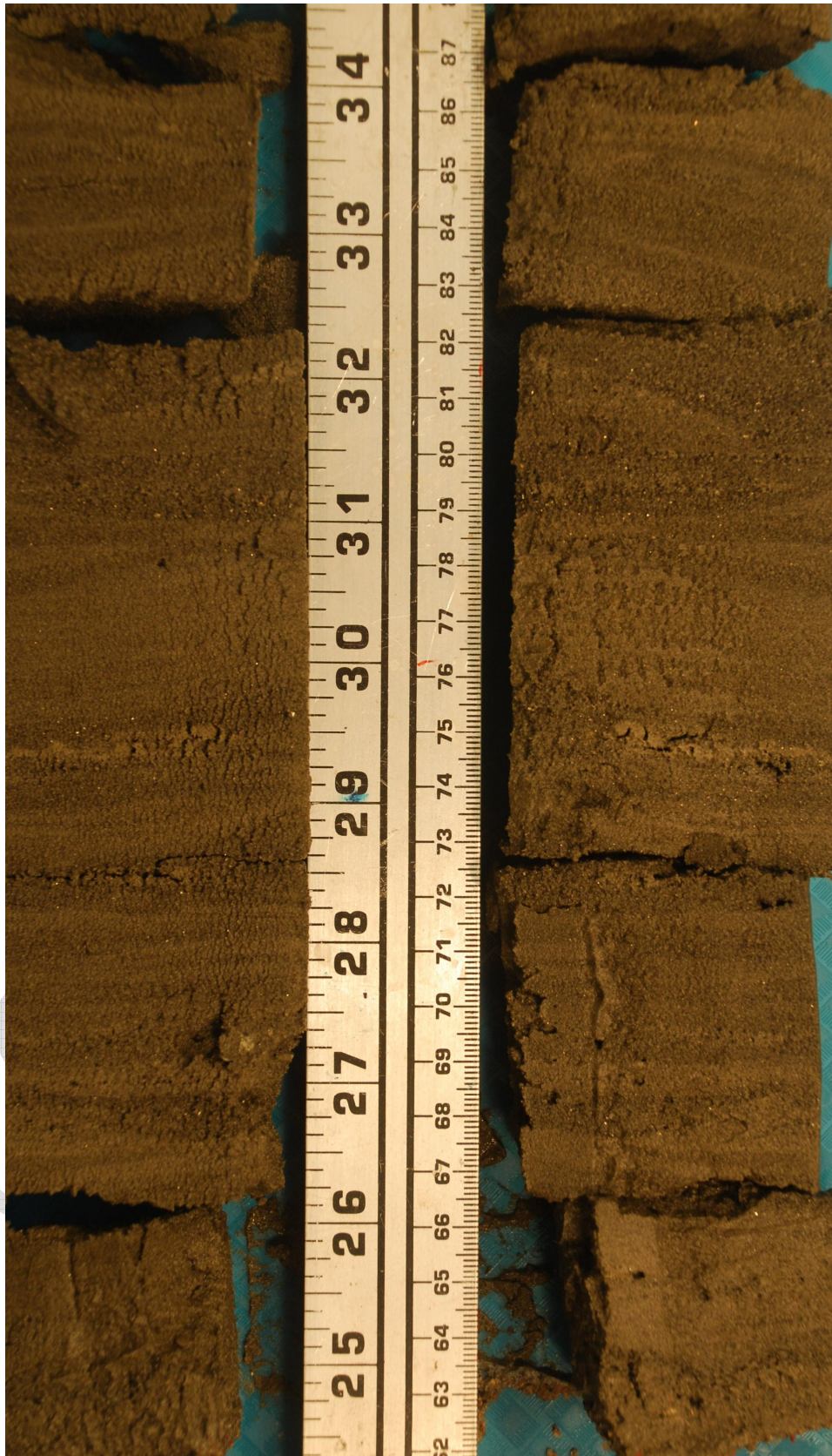

Figure 21a – Grain image from piston core 01 (r = 30cm)



Figure 21b – Grain image from piston core 03 (r = 90cm)





Figure 21c – Grain image from piston core 04 (r = 120cm)



Figure 21d – Grain image from piston core 12 (r = 150cm)

### 5.4.2 Freeze Slices

As noted in Section 5.4.1 light and dark lenses were observed within the suction cores. The freeze slices, taken from the final deposit of Run 2, were intended to determine the lateral extent of the lenses and how interconnected they are. Figure 22a shows the freeze slice locations, and Figures 22b and c are images of frozen sediment slices from Run 2 taken at  $r = 55\text{cm}$  (1.8ft) and  $r = 150\text{cm}$  (5ft), respectively. Figure 22b shows that at the upstream end of the delta the dark lenses are large and often connected over the length of the deposit. The crack in the Figure 22b slice is due to the thawing process. It was not present within the deposit. In Figure 22c, at the downstream end of the delta, the dark lenses are more likely to be completely encased in fines.

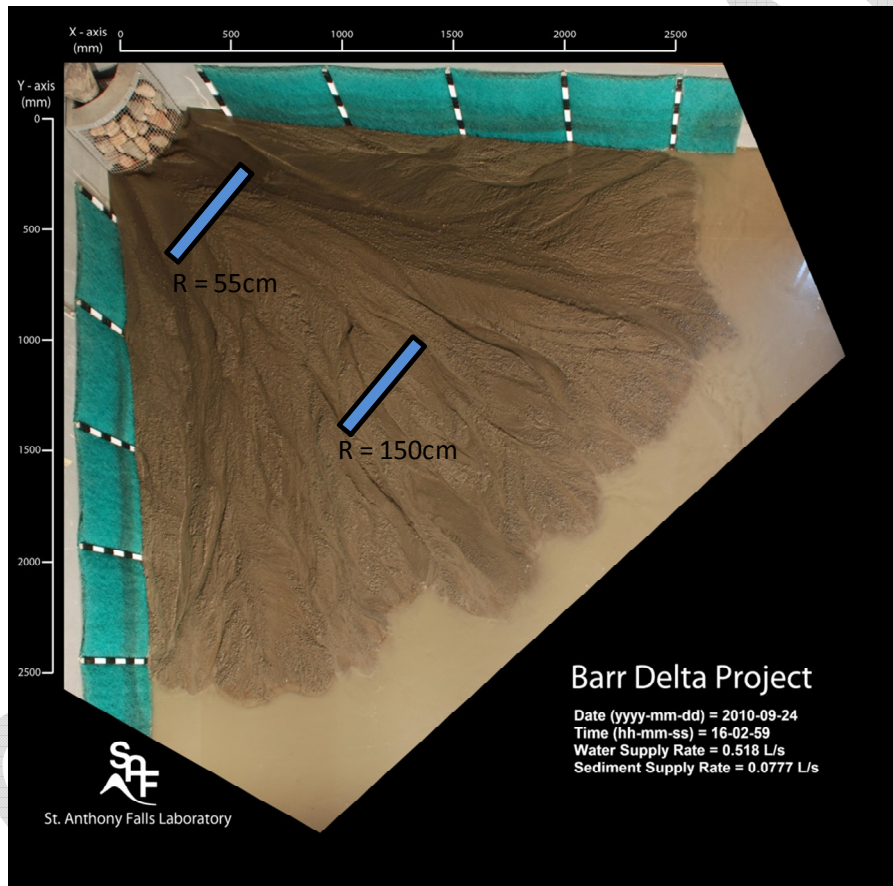

Figure 22a – Freeze slice locations.

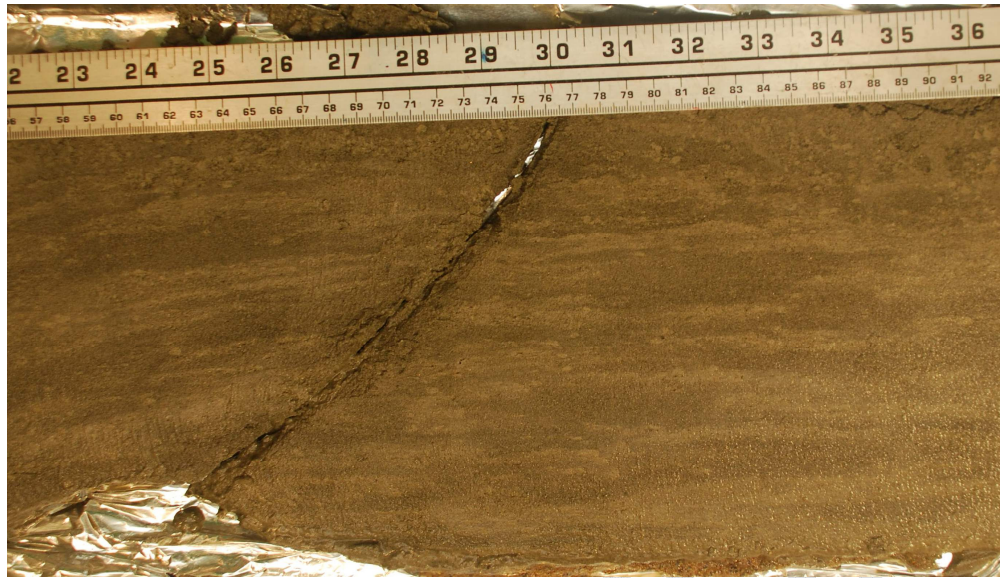

Figure 22b – Run 2 freeze slice taken at  $r = 55\text{cm}$ . Looking upstream.



Figure 22c – Run 2 freeze slice taken at  $r = 150\text{cm}$ . Looking upstream.

#### **5.4.2.1 Freeze Slice Grain Size Distributions**

The freeze slices were subsampled to determine the grain size distributions from the light and dark lenses. The sampling locations are given in Figures 23a and 23b. The samples were analyzed for grain size distribution using Horiba® laser diffraction. The results provided in Figure 24 show that there is quite a bit of variability in the 10 to 74  $\mu\text{m}$  grain sizes. Figures 25a and 25b have the coarse fractions (above 74 microns) labeled directly on the freeze slice images. Note the darker lenses tend to have higher coarse fractions than the lighter lenses, though the trend seem to be less consistent at 150cm The coarse fraction observed in the freeze sliced are within the range of coarse fractions observed in the scrape samples (Fig. 17g).

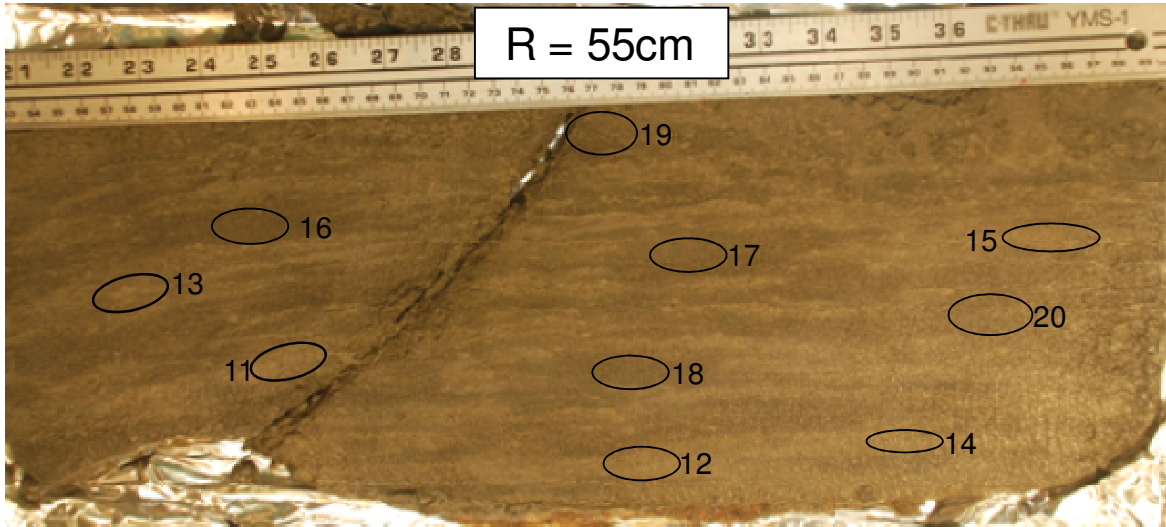

Figure 23a – Subsample Locations for the Freeze Slice at  $r = 55\text{cm}$  (The sample number are indicated)

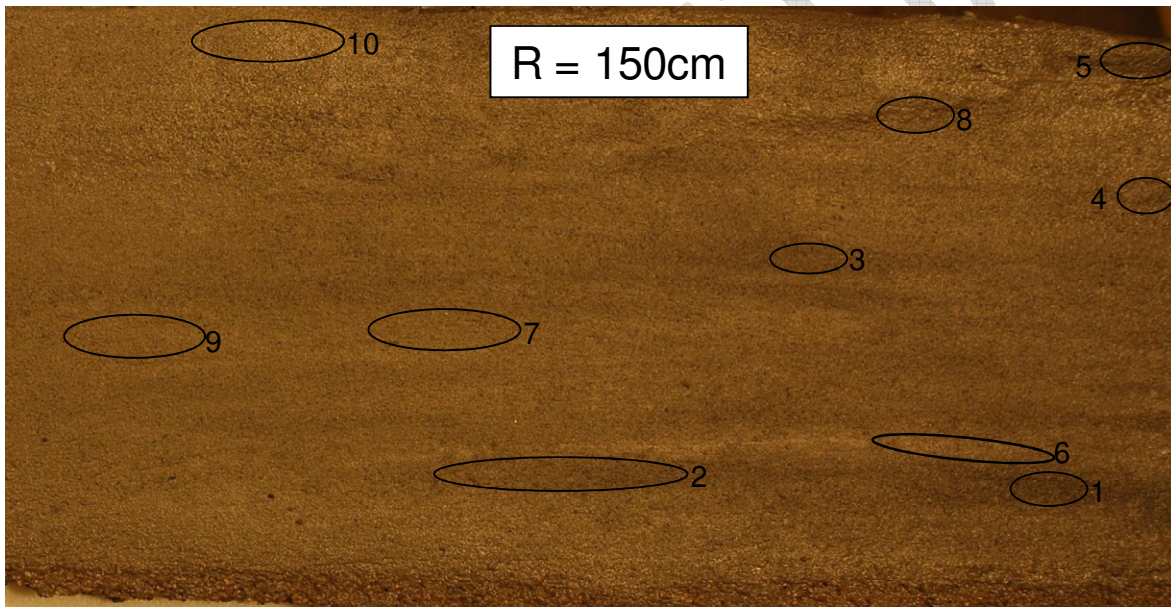

Figure 23b – Subsample Locations for the Freeze Slice at  $r = 150\text{cm}$  (The sample number are indicated)

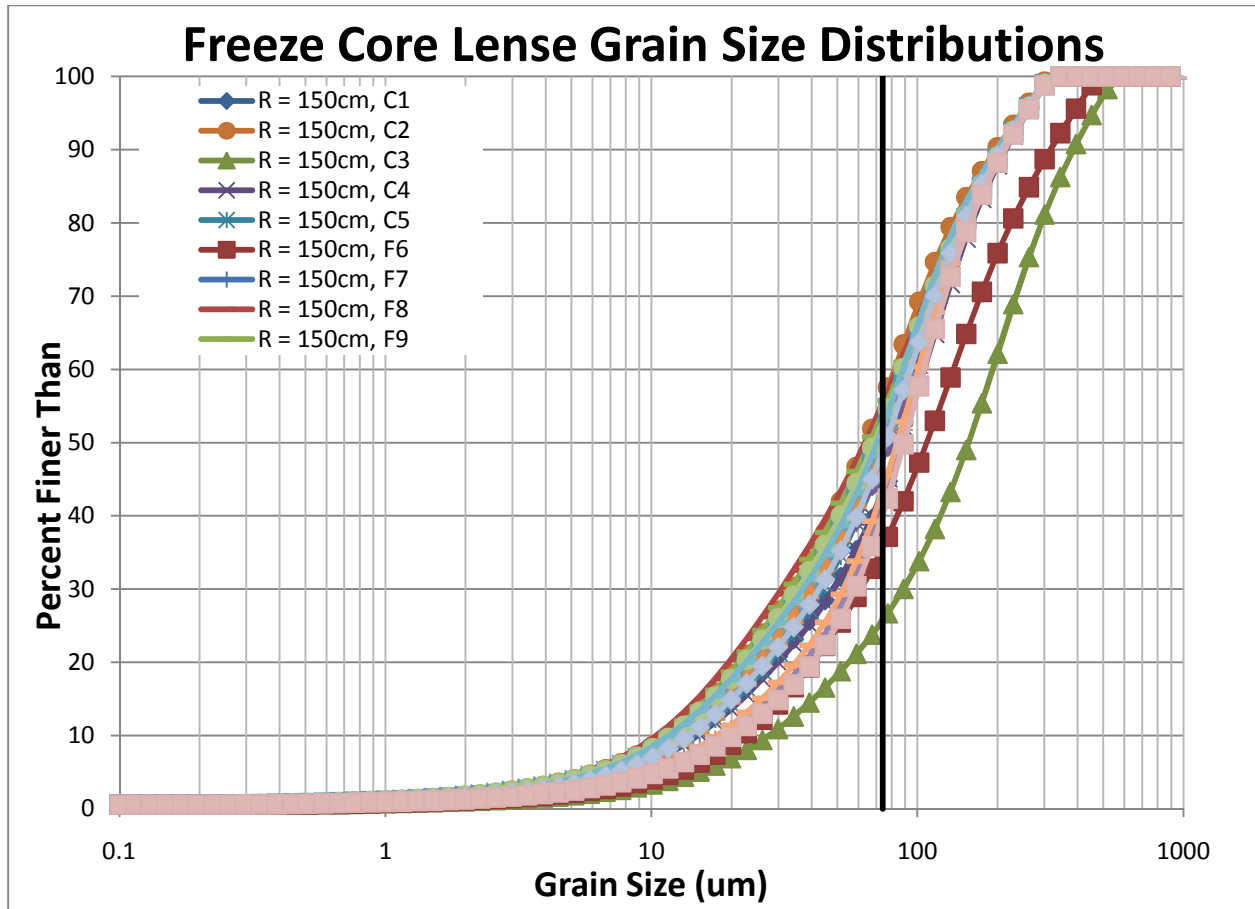

Figure 24 – Grain Size Distributions from Freeze Slice Subsamples

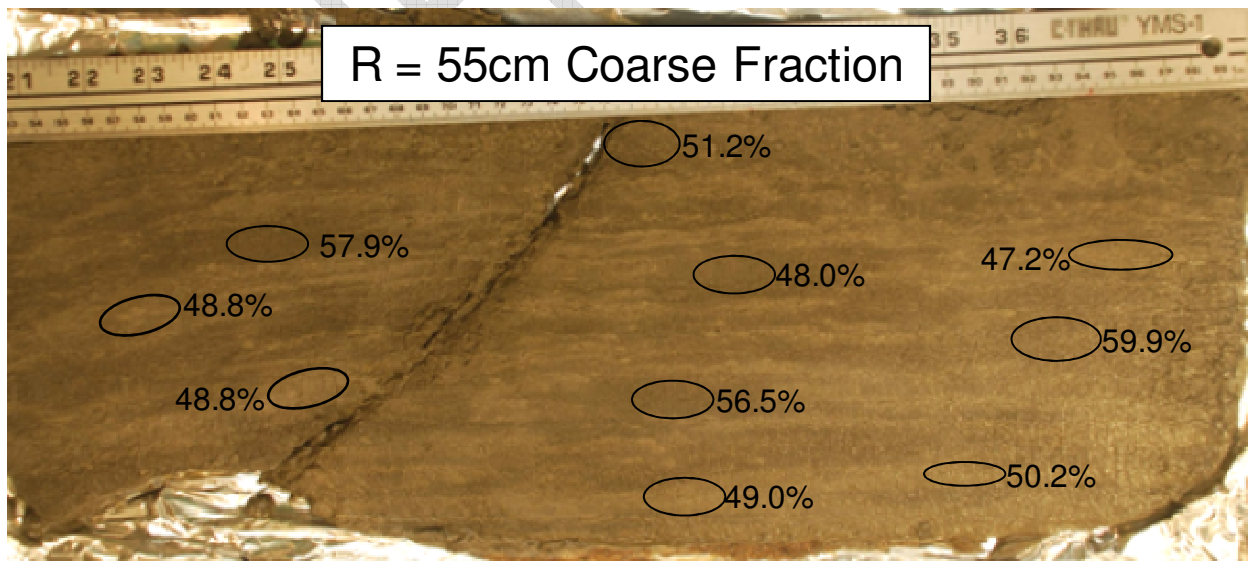

Figure 25a – Coarse Fraction (above 74um) from the Freeze Slice at r = 55cm

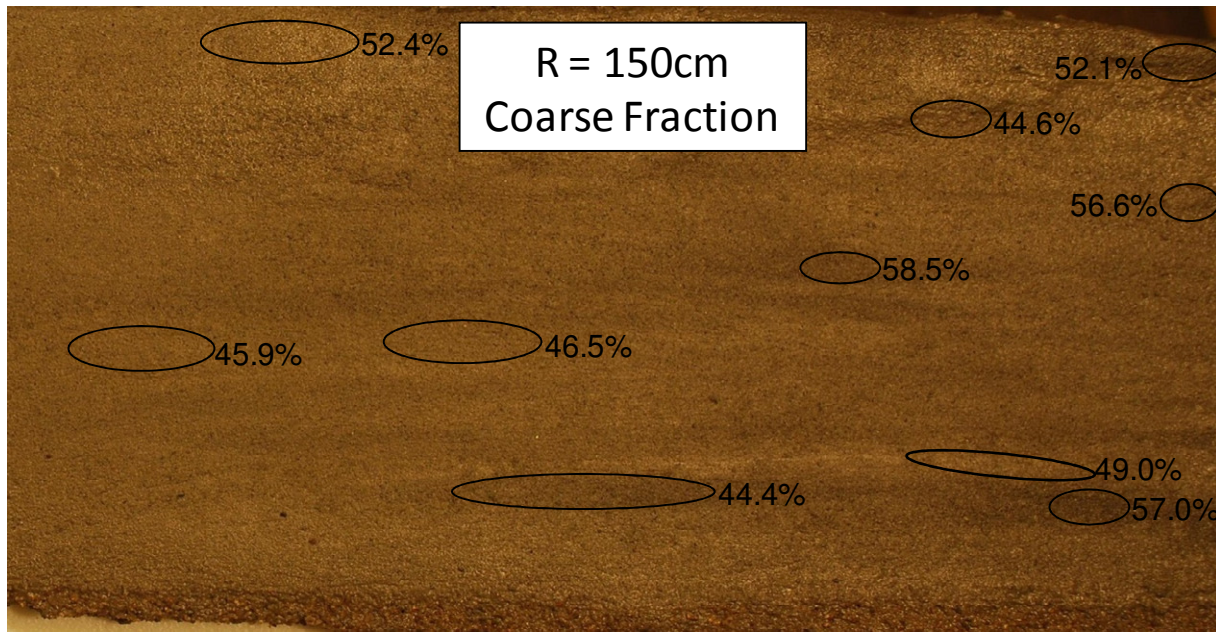

Figure 25b – Coarse Fraction (above 74 $\mu$ m) from the Freeze Slice at r = 150cm

#### 5.4.2.2 Freeze Slice Permeability

Although it is not possible to directly measure the permeability at each of the sampling points within the freeze slices, the permeability can be estimated from the grain size distribution. Beard and Weyl (1973) studied how the grain size distribution of artificially-mixed, wet-packed sand influences permeability. They found that permeability increases with increasing  $D_{50}$  (mean grain size) and decreases with an increasing sorting coefficient ( $D_{75}/D_{25}$ ).  $D_{25}$ ,  $D_{50}$ , and  $D_{75}$  are the grain diameters corresponding to 25, 50, and 75 percent finer than in Figure 24. The relationship between the sorting coefficient and permeability is stronger than the relationship between grain size and permeability. In other words, a coarser material is more conductive, but adding a small amount of fines fouls the coarse matrix and reduces flow. The matrix of grain size, sorting coefficients, and permeability developed by Beard and Weyl can be approximated using a power law equation. Because different materials are used, the permeability from Beard and Weyl's matrix may not predict the actual permeability of the tailings deposit; however, the range and spatial distribution of the subsample permeabilities should give a good relative indication about which zones of the freeze slice are more likely to allow or impede water flow.

Figures 26a and 26b provide the Beard and Weyl estimate of permeability (in mDarcy) for the different lenses of the freeze slices. The average Beard and Weyl permeability in the upstream freeze slice is higher than in the downstream freeze slice. This result is consistent with the rigid wall hydraulic conductivity measurements from Run 1 (Figure 20). At the downstream end the Beard and Weyl permeability is similar throughout the slice; however, at the upstream end the Beard and Weyl permeability is typically greater for the darker lenses. This result is consistent with the findings from Figure 25. We also note that the highest estimated permeabilities would control the bulk permeability for cases where the coarse (dark) depositional units are connected so as to provide an unbroken flow path through the deposit.

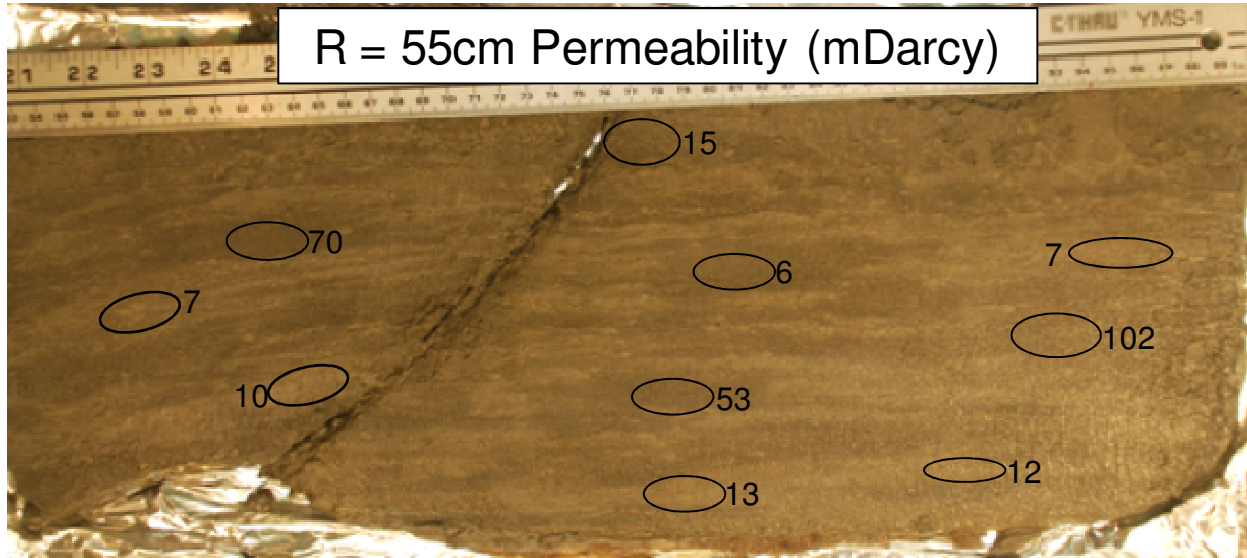

Figure 26a – Beard and Weyl permeability (in mDarcy) for the Freeze Slice at  $r = 55\text{cm}$

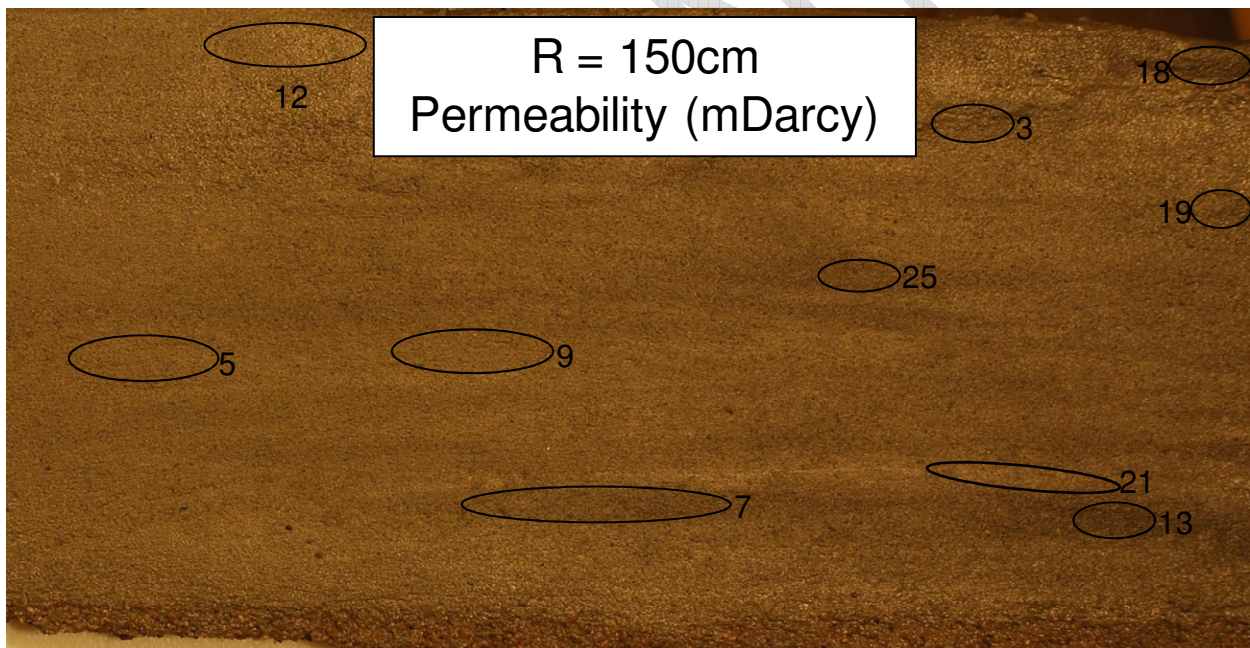

Figure 26b – Beard and Weyl permeability (in mDarcy) for the Freeze Slice at  $r = 150\text{cm}$

## 5.5 Topographic Scans

The field delta geometry was evaluated as part of the one-dimensional experiments. The reduced slurry discharge required to preserve the aspect ratio resulted in a model delta geometry that does not directly translate to the field delta. For Run 1, the beach slope was on the order of 4%. Figure 27(a-g) shows topographic maps of the Run 1 and 2 deltas at the end of each phase. The figures provide further documentation of the variability of the surface topography and chaotic nature of the deposition process. It is interesting to note the shape of the shoreline and how it deviates



from an ideal cone-shape. Also, studying the distal portion of the deltas in all images shows distinct depositional lobes that appear to weave together as the distal fan is constructed. These are the processes that create variability in the grain size, coarse fraction, and visual variability that was observed in these tests.

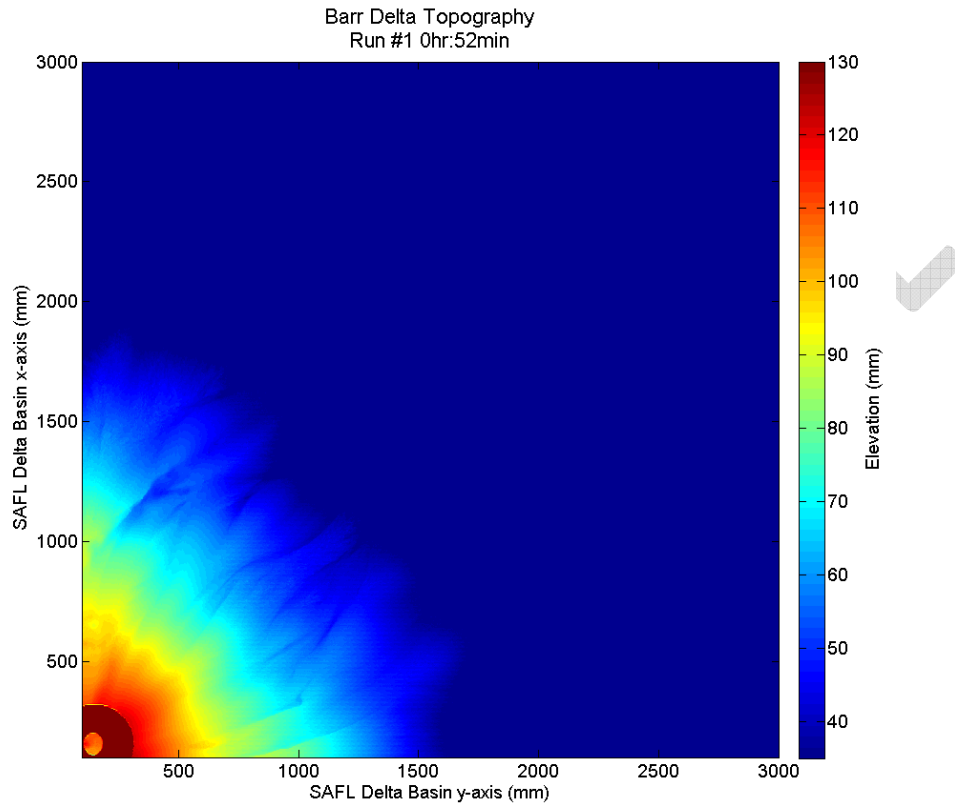
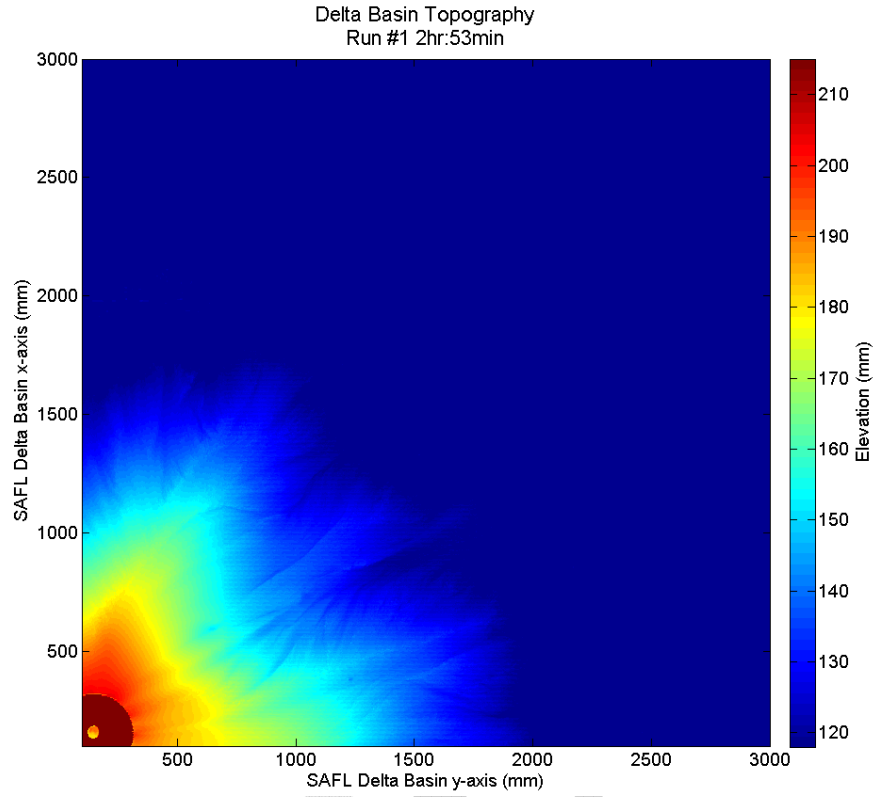
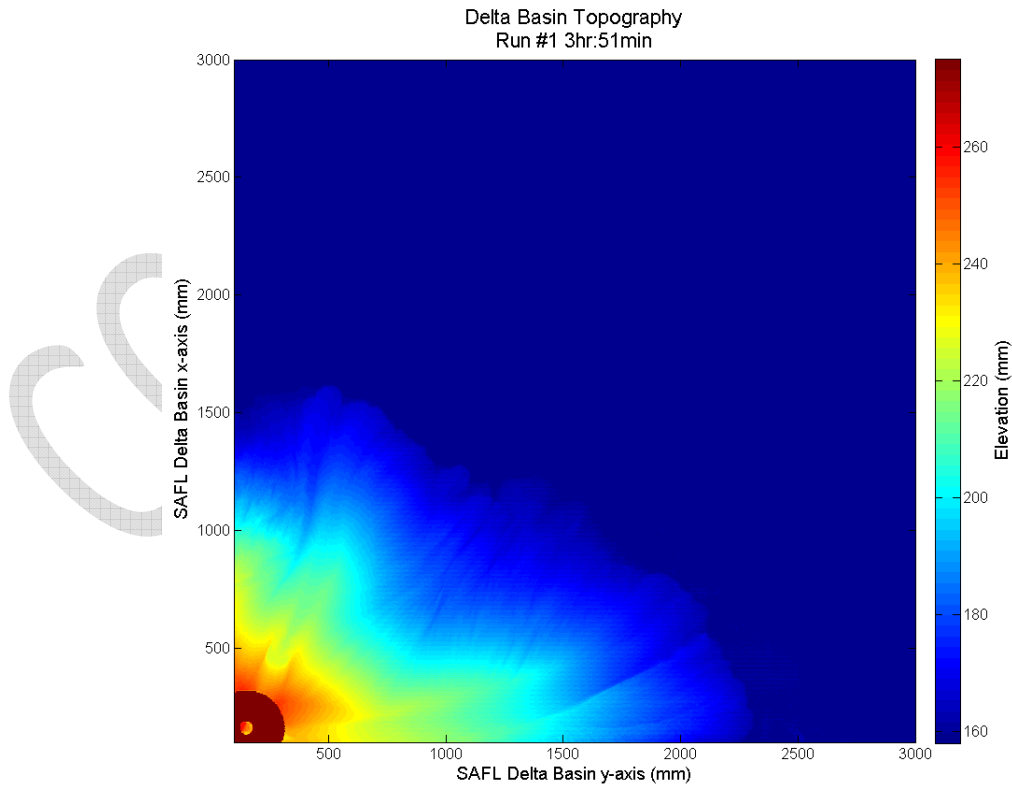

Figure 27a – Run 1 topography at the end of the growth phase



**Figure 27b – Run 1 topography during the building phase**



**Figure 27c – Run 1 topography at the end of the building phase**

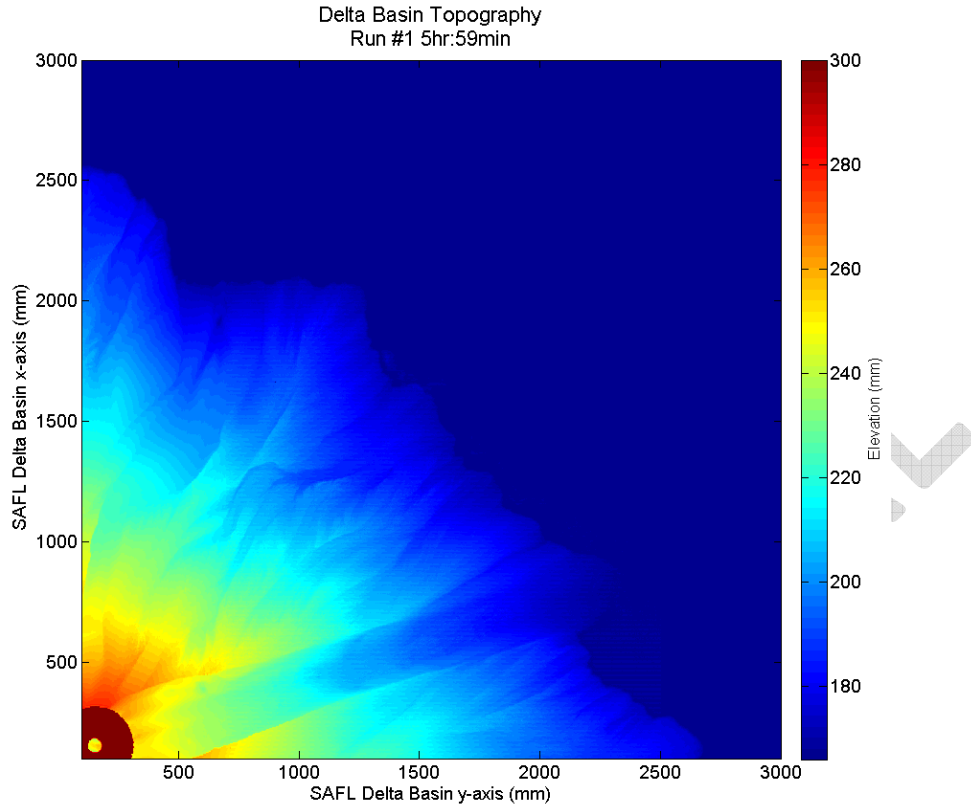

**Figure 27d – Run 1 topography at the end of the falling phase**

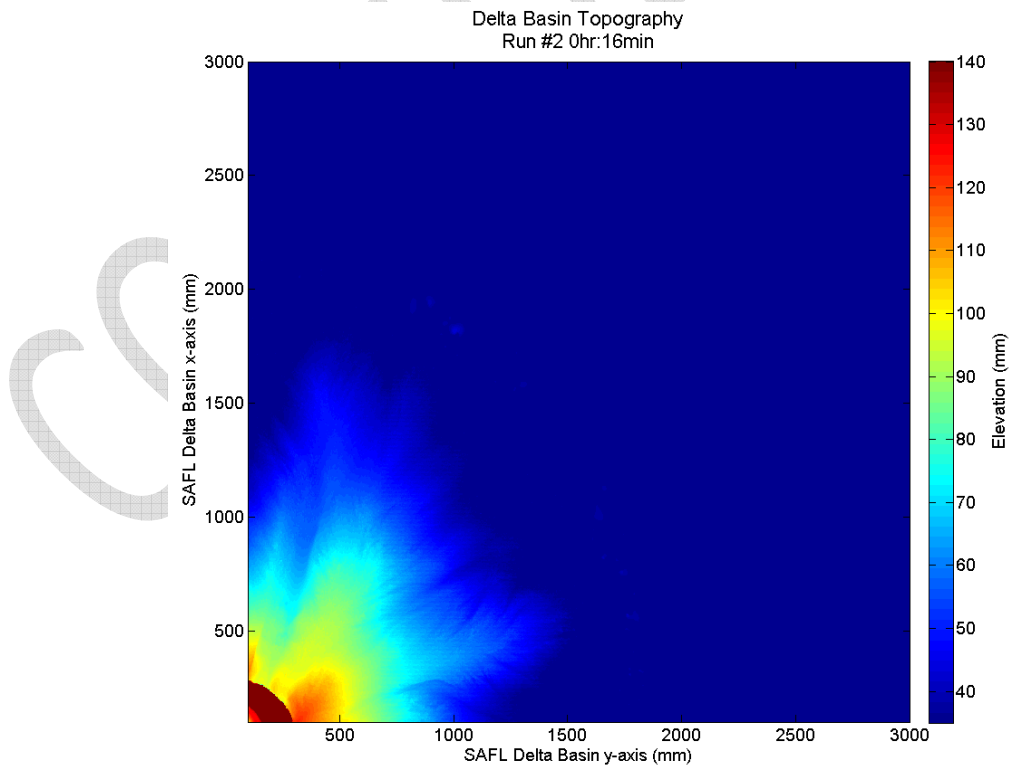

**Figure 27e – Run 2 topography at the end of the growth phase**

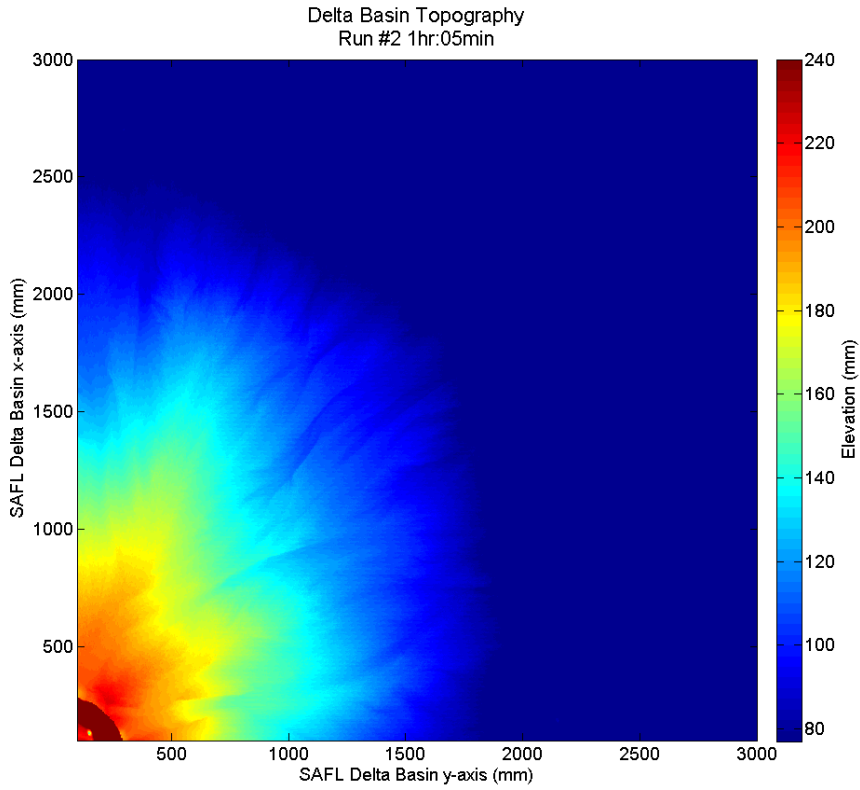

**Figure 27f – Run 2 topography at the end of the building phase**

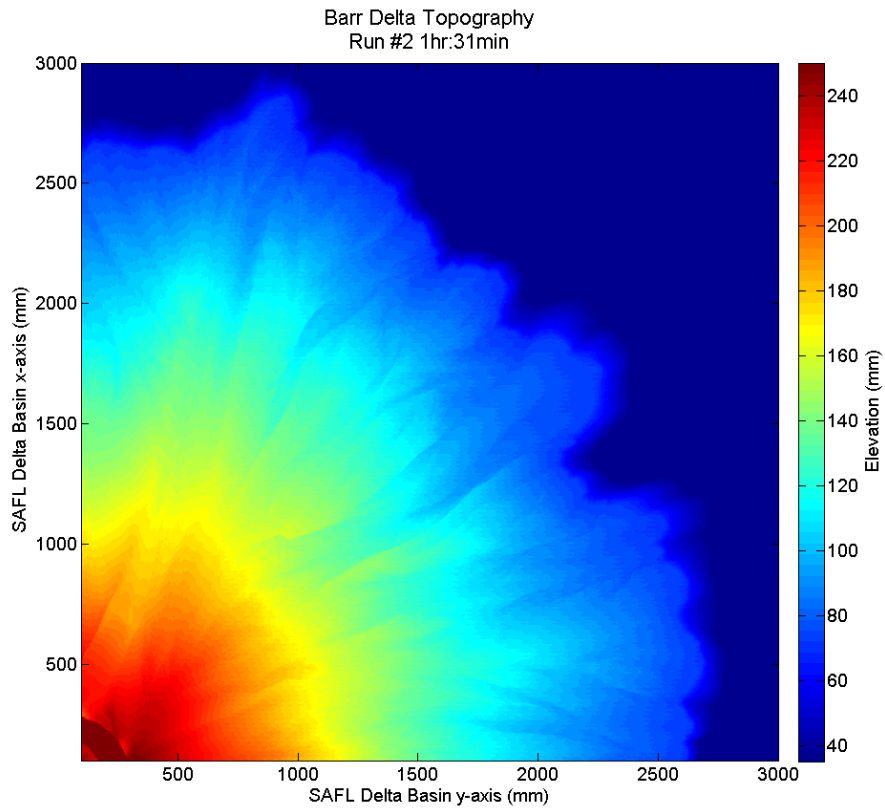

**Figure 27g – Run 2 topography at the end of the falling phase**

## 6.0 Phase II – Discussion

---

### 6.1 Phase II Results

The goals of the 2D experiments were to 1) determine the expected lower limit of fines concentration in the deposit, 2) determine the degree of grain size segregation both vertically and horizontally within the deposit and 3) evaluate the potential range of hydraulic conductivity throughout the model delta.

The lower limit of fines concentration and the degree of grain size segregation are both functions of fines retention within the deposit. There are several factors that likely influenced fine particle retention within the deposit. One such factor is that the grain size distribution and concentration of the tailings was conducive to fines retention. The range of particle sizes was sufficient and the concentration was high enough that in a shallow flow, such as the flow seen on a delta fan, the larger particles interact with the smaller particles strongly, and both are deposited together. This was observed in the generally high fines contents measured in the scrape samples and in the freeze cores.

The data consistently showed a downstream (nearer the shoreline) trend of increasing fines fraction within the deposit. This observation is likely representative of what would be observed in the field. The coarsest material will deposit in the proximal region of the delta and distally, where the energy of the flow is distributed across a larger fan surface and slopes are milder, fine material will be preferentially deposited. This process is depicted in the mild downward trend seen in Figures 16b, 16b, and 16d. Variability of downstream fining is likely due to the chaotic nature of deltaic transport and deposition of sediment. Braiding, avulsion (see step three of delta evolution below), and bar and bedform movement act to mix surface layers both vertically and horizontally, even as local channel processes create spatially distinct grain size zones. The effect of these processes can be seen in all of the aerial photos and their influence on fines retention is evident in the spikes seen in Figure 16d. Throughout the evolution of the delta, channels with flowing water and sediment sweep across the surface. This process likely accounts for the variability of the coarse fraction data seen in Figures 16e and 16g. This process also accounts for the light and dark lenses seen in Figures 26a and b. The larger, more pronounced lenses in the  $r = 55$  cm freeze slice (Figure 26a) are due to narrower, deeper, and more active channels at the upstream end of the delta. At the downstream end much more of the delta is covered with unchannelized sheet flow. This results in the thinner, wider, and less distinct lenses seen in the  $r = 150$  cm freeze slice (Figure 26b). Figures 28 show these channel characteristics and a sequence of channel evolution.

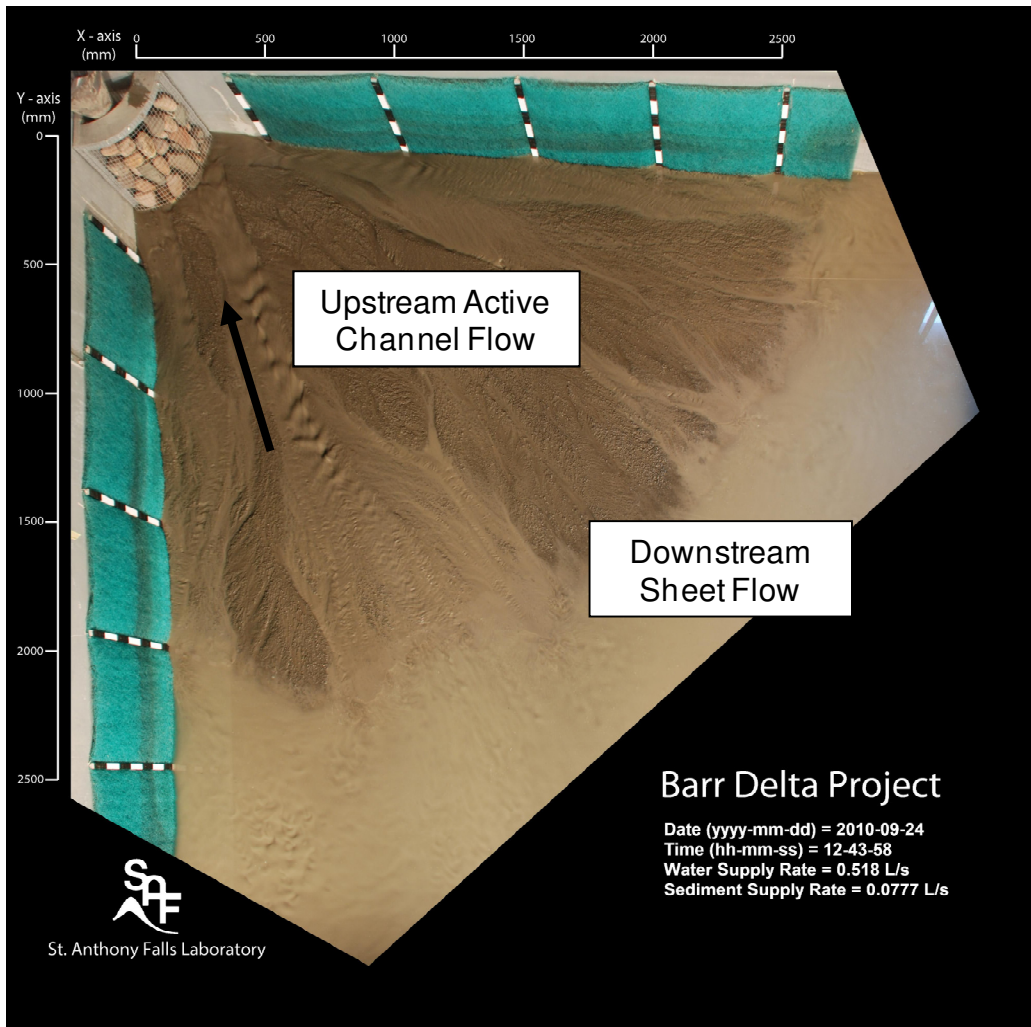

**Figure 28a – Channel Evolution Step 1**

As more sediment is delivered downstream, the downstream sheet flow zone grows a lobe and the channel cut begins to fill in.

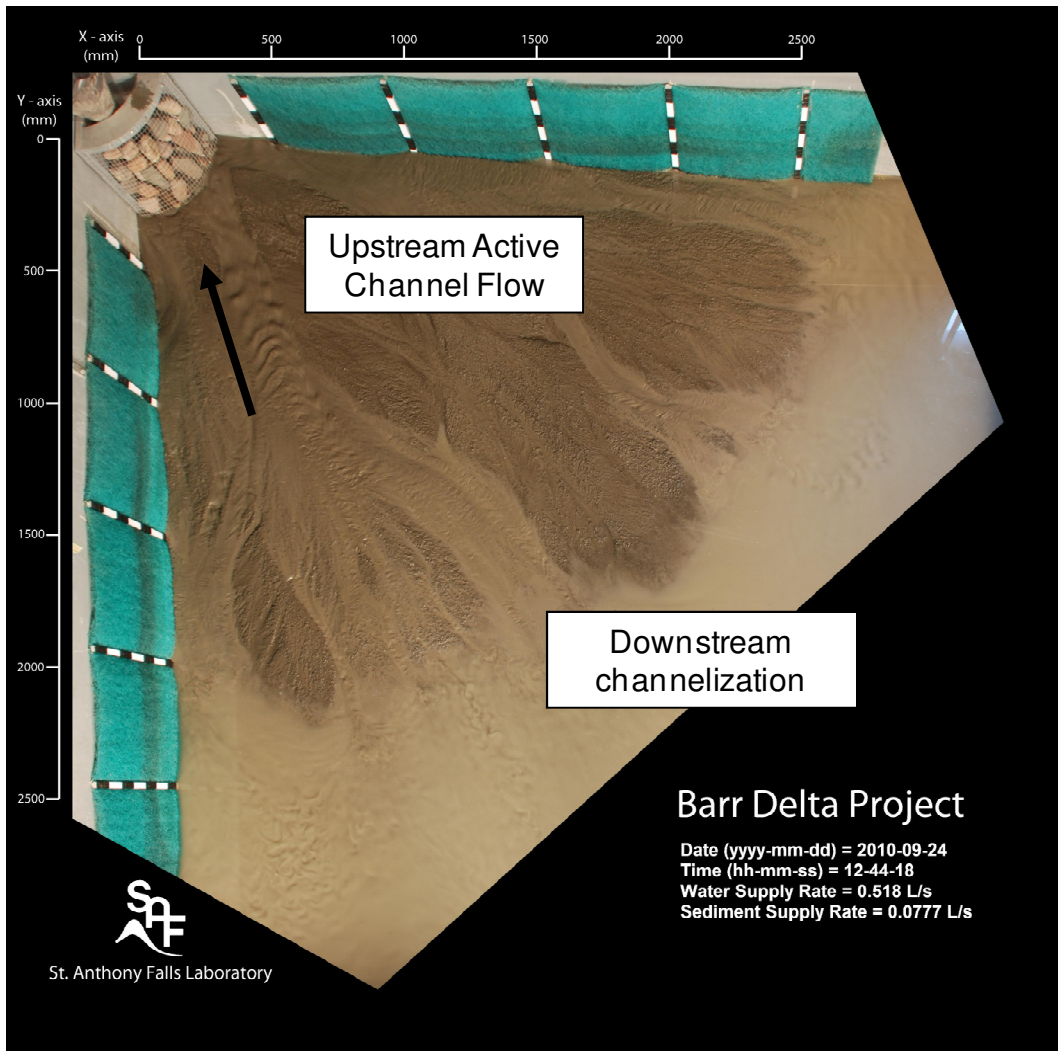

**Figure 28b – Channel Evolution Step 2**

Once the downstream deposit below the downstream lobe becomes too thick the downstream sheet flow splits into smaller channels, delivering sediment to the lower downstream areas. The upstream channel continues to fill in.

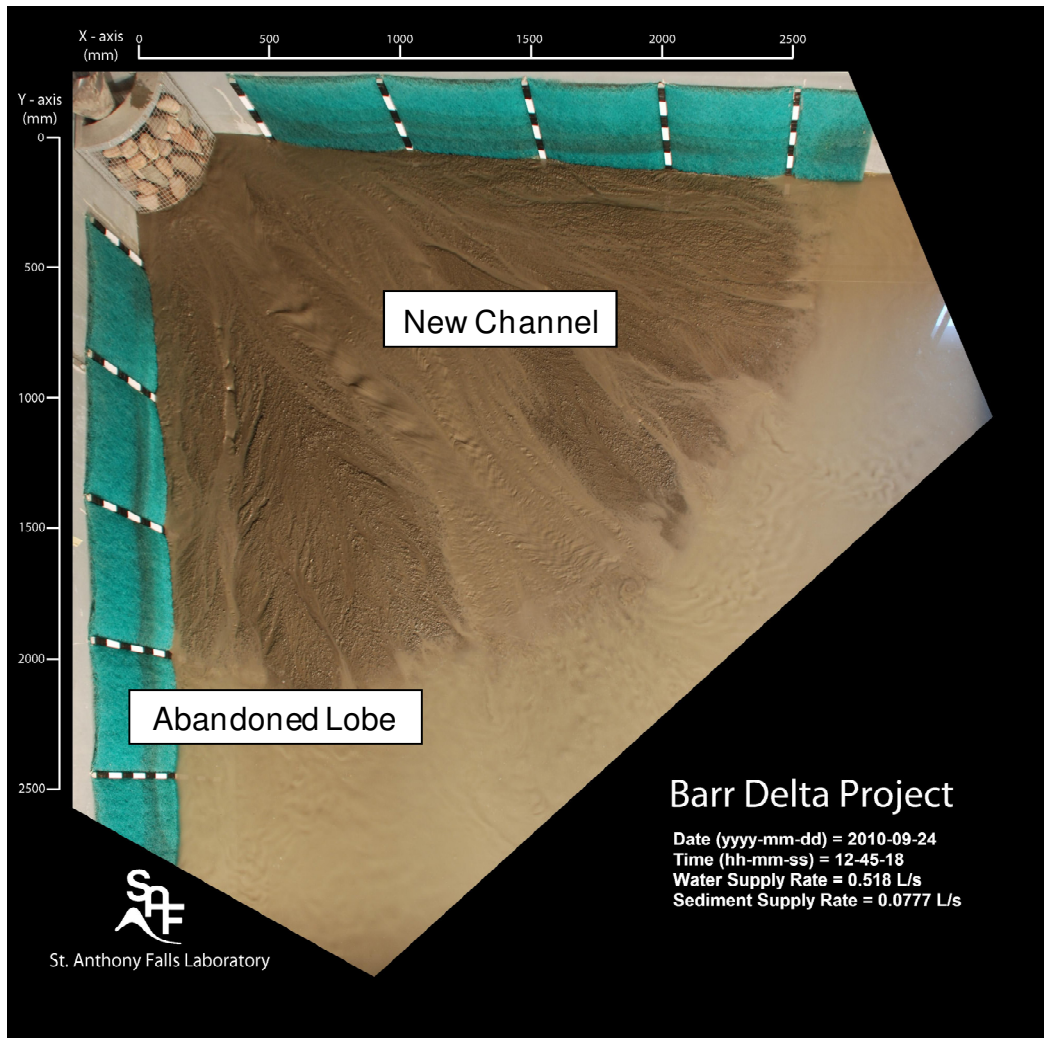

**Figure 28c – Channel Evolution Step 3**

Once the upstream channel fills in with sediment it avulses to a new location, cutting a new channel and abandoning the previous downstream lobe.



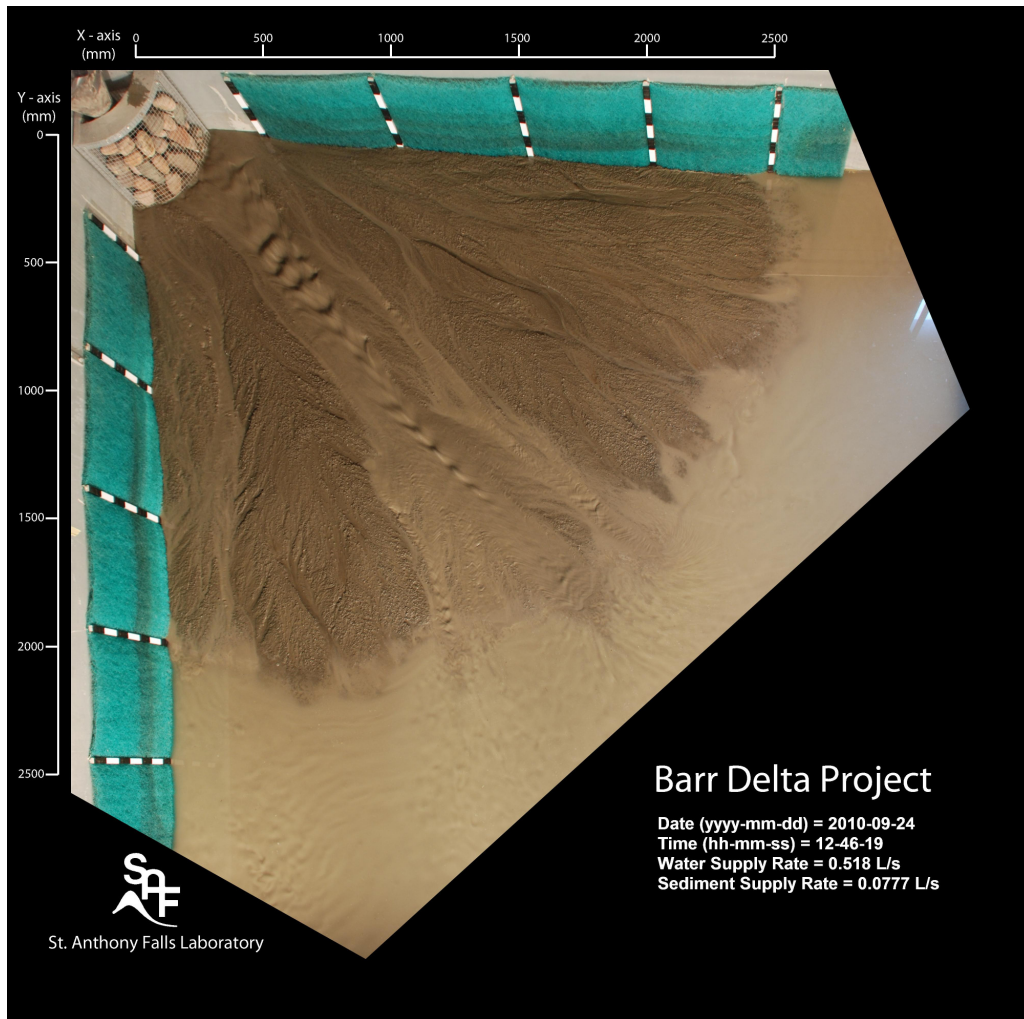

**Figure 28d – Channel Evolution Step 4**

Finally a new lobe forms at the downstream end of the new channel and the avulsion process start over again. This process has been observed over a range of scales and settings (Sheets and Hoyal 2009).

With these fines retention processes in mind, remember that the falling phase of the runs were designed to maximize channelization on the surface of the deposit. Maximum channelization results in minimum fines retention. This leads to the conclusion that the delta surface at the end of the falling phase should contain the absolute minimum fines that can be expected anywhere within the delta. This conclusion is supported by Figure 16g. From this conclusion one can expect a minimum of 30% fines retention everywhere within the delta.

The final deposit does show some grain size sorting characteristics. The upstream end of the delta spends more time under deep, narrow channels that generate thicker and more pronounced coarse lenses while the downstream end of the delta spends more time under shallower wider channels that generate thinner, more uniform lenses. In general, the results suggest that the field scale delta will have more pronounced coarse lenses at the upstream end of the fan with an

overall trend of downstream fining. Even these coarse lenses, however, should retain a fines fraction of ~30% or more.

At the upstream end the thickness and interconnected nature of the dark/coarse lenses indicate that infiltrating groundwater will likely bypass the light/fine lenses; consequently, groundwater transport will likely be greater at the upstream end of the delta than at the downstream end. This means that the hydraulic conductivity measurements taken in Section 5.2 can only be used as a lower limit of the effective hydraulic conductivity.

The laboratory experiment was designed to capture the main processes and channelization expected in the tailings pond delta. In other words, the laboratory delta is expected to grow and maintain its surface by the same mechanisms as the field scale delta. As such, the minimum fines retention and degree of grain size sorting seen in the experiment should be similar to that in the field scale delta. The field scale delta should also exhibit spatially variable hydraulic conductivity comparable to that seen in the laboratory scale delta.

## **6.2 Delta Drainage**

Many experimental deltas have been built in the SAFL delta basins. In most cases the delta basin is drained at the end of the experiment and the delta is dry enough to be sliced in about a week. Six weeks after the completion of Run 1 the delta deposit was still near saturation. The following questions need to be addressed: 1) why did the laboratory scale delta retain water, and 2) will the field scale delta also retain water at near saturation? There are several possible explanations for this behavior which will be discussed in the following sections.

### **6.2.1 Low Permeability**

Firstly, considering the primary difference between these laboratory scale deltas and previous delta experiments, the tailings used in this study had much higher fines content than previous experiments. In previous experiments the sediment was hand mixed. For both physical and safety reasons in previous experiments coal was used in place of the finest fraction of the sediment. The lower density of coal allows it to transport at a rate similar to the prototype (actual) fine material; however, the larger particle sizes of coal increase the permeability of the deposit. The inclusion of the “real” fine particles in the deposit greatly reduce the permeability of the deposit and thereby increase the drainage time; however, the decreased permeability alone is not sufficient to describe the prolonged water retention within the delta deposit.

### **6.2.2 Suspended Capillary Water**

In order for water to be trapped in the delta deposit via capillary suction, the material must be unsaturated. In addition, soil suction and percent saturation are inversely related (see the SWCC provided by Daniel B. Stephens & Associates (DBS&A) Laboratory). The inclusion of fine material instead of coarser coal increases the soil suction pressures over previous experiments. The deposit was fully saturated at the end of the experimental run. The moment the delta began to drain the deposit became unsaturated. Figure 29 is a diagram of the system being investigated and the corresponding pressures.

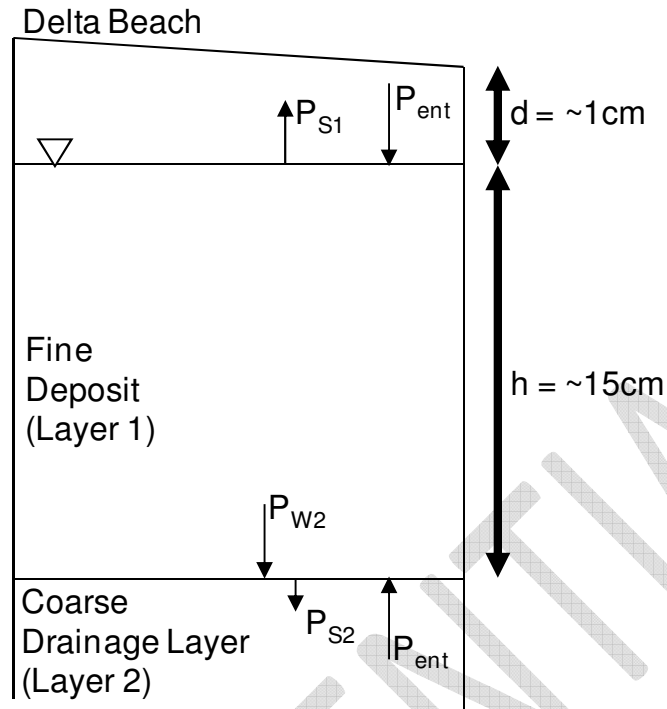

Figure 29 – Diagram of water column and associated pressures.

Where:  $P_{S1}$  = suction pressure of the deposit layer  
 $P_{S2}$  = suction pressure of drainage layer  
 $P_W$  = water pressure at bottom of the deposit  
 $P_{ent}$  = atmospheric entrance pressure

The fine deposit layer has an upward suction pressure inversely related to the percent saturation. The coarse drainage layer has a much lower downward suction pressure. The water pressure balance for trapping water in the fine layer above a coarse layer is given by equation 11.

$$P_{S2} + P_W > P_{S1} \quad (11)$$

The drainage layer suction pressure and the weight of the water act to drain water from the delta, while the deposit suction pressure acts to retain water within the delta. The suction pressure of the drainage layer is much lower than the suction pressure of the deposit and can be neglected. As such, if the water pressure due to the height of the deposit is equal to the suction pressure of the deposit, the water in the deposit will be retained. The water pressured generated by 15 cm (6in) of water is 1.47 kPa or 0.0174 bar. Based on the SWCC provided by DBS&A for the tailings material, the suction pressure of the deposit is equal to 0.0174 bar when the percent

saturation is equal to 85-98%. In conclusion, suspended capillary water itself is sufficient to explain the water retention within the laboratory delta deposit.

### **6.2.3 Influence of Fluvial Deposition**

The SWCC generated by DBS&A was created by testing artificially sorted and mixed tailings samples. It is entirely possible that the SWCC will be different for a fluvial deposit created from the same material. A flowing system may orient the particles differently or change the packing characteristics. This is a common problem in the construction industry. When mechanically placing construction fill it can be challenging to achieve compactions as high as field conditions and impossible to match them. The opposite is also true in laboratory settings; it can difficult to achieve loose compaction conditions or match fluvial deposition conditions.

Under fluvial deposition, angular fine particles may orient themselves and interlock in such a way that nearly all of the void space is composed of “micropores.” Micropores are pore spaces so small that water contained within them will not drain by gravity and is only removed by suction and evaporation. The influence of fluvial deposition in itself is sufficient to explain the water retention found in the laboratory delta deposit.

### **6.2.4 Field Delta Drainage**

The lack of drainage in the laboratory scale can be satisfactorily explained by suspended capillary water and/or fluvial deposition processes. Unfortunately the qualitative observations made of the laboratory scale delta drainage are insufficient to definitively say which process is responsible the water retention. It is most likely a combination of the processes.

In the field scale delta the thickness of the deposit means that suspended capillary water will not be able to retain water at near the saturation point as in the experiments, because the column pressure will be higher. On the other hand, if the fluvial deposition mechanism does actually generate the majority of void space as micropores, then the field scale delta could also retain a high percentage of water.

## 7.0 Conclusions

---

Physical experiments were conducted to explore the transport and depositional characteristics of prototype tailings material. The experiments were conducted in two phases; the first phase used 1D flume experiments under field-scale conditions and Phase II involved 2D scaled experiments to investigate channelization and its consequences. The experimental findings are summarized here:

- Field scale slopes are anticipated to range from 0.5 to 2%. The 1% slope used for field scale design is reasonable.
- The delta will operate in a fluvial braided channelized regime characterized by multiple channels, rapid channel migration, and dynamic bar and bedform processes.
- The deposit will likely experience both vertical and horizontal sorting of grains. The coarsest portion of the deposit will be the proximal region of the delta and the distal region will have higher fines content.
- The multi-channel fluvial processes will create a deposit that has buried channels in the subsurface. The hydraulic interconnectedness of these channels has not been explored quantitatively in this study but visual observation suggests that channels will be connected vertically and laterally, especially in the upstream part of the deposit.
- Even under the most extreme plausible transport conditions, it was difficult to generate a deposit with less than 30% fines content in the deposit. This suggests that, even though channelization generally moves fine material offshore, bypassing the subaerial delta, a significant fraction of the fines in the tailings material is co-deposited with coarser material. These levels of trapped fines will significantly reduce conductivity relative to a well sorted deposit of the same median size.
- Hydraulic conductivities measured on piston cores taken from the laboratory deposits are relatively low due to conductivity in cores being limited by the presence of fine layers in the cores. Because 3D groundwater flow in the field may exploit connected high-conductivity pathways through the deposit, the values measured with cores represent the low end of conductivities expected for field conditions.
- The degree of water retention in the field scale deposit was inconclusive. The estimated deposit thickness and the SWCC for the tailings suggests that suction will not be great enough to keep the deposit saturated; however, internal structures such as lenses, discontinuities, or micro-pores associated with the natural deposition of the deposit may increase the suction pressure of the material.

There are several design alternatives that could potentially increase fines retention. Reducing the water content of the slurry such that the delta/beach behaves as a debris (“mud”) flow would be expected to enhance fines retention although no tests were done on this transport mode in this

study. The delta could be operated such that there are periods of receding shoreline produced by raising the pool level. Switching between multiple spigot locations could also be timed to achieve a similar effect. These alternatives focus only on increasing fines retention. There may be other physical or operational considerations that make them unfeasible.

---

## 8.0 References

- Beard, D. C., and Weyl, P. K., 1973, Influence of texture on porosity and permeability of unconsolidated sand: AAPG Bulletin, v. 57, p. 349-369.
- Hoyal, D. C. J. D., and B. A. Sheets (2009), Morphodynamic evolution of experimental cohesive deltas, J. Geophys. Res., vol 114, doi:10.1029/2007JF000882.
- Parker, G., 1976, On the causes and characteristic scales of meandering and braiding in rivers, J.Fluid Mechanics, vol 76, part 3, pp 457-480.

CONFIDENTIAL

## Appendix A – Feed Material Grain Size Distribution

CONFIDENTIAL

## Appendix B – Scrape Sample Grain Size Analysis

Run #	Phase	Sample #	$\theta$	r (cm)	% > 74 $\mu$	% < 74 $\mu$	Coarse/Fine Fraction
1	End of Growth	1	$\pi/8$	25	0.63	0.37	1.67
1	End of Growth	2	$\pi/8$	40	0.55	0.45	1.23
1	End of Growth	3	$\pi/8$	55	0.66	0.34	1.91
1	End of Growth	4	$\pi/8$	70	0.72	0.28	2.62
1	End of Growth	5	$\pi/8$	85	0.73	0.27	2.76
1	End of Growth	6	$\pi/8$	100	0.70	0.30	2.29
1	End of Growth	7	$\pi/8$	115	0.68	0.32	2.08
1	End of Growth	8	$\pi/8$	130	0.63	0.37	1.68
1	End of Growth	9	$\pi/8$	145	0.56	0.44	1.27
1	End of Growth	10	$3\pi/16$	25	0.53	0.47	1.11
1	End of Growth	11	$3\pi/16$	40	0.59	0.41	1.46
1	End of Growth	12	$3\pi/16$	55	0.74	0.26	2.91
1	End of Growth	13	$3\pi/16$	70	0.69	0.31	2.23
1	End of Growth	14	$3\pi/16$	85	0.58	0.42	1.41
1	End of Growth	15	$3\pi/16$	100	0.59	0.41	1.45
1	End of Growth	16	$3\pi/16$	115	0.65	0.35	1.82
1	End of Growth	17	$3\pi/16$	130	0.64	0.36	1.77
1	End of Growth	19	$\pi/4$	25	0.39	0.61	0.64
1	End of Growth	20	$\pi/4$	40	0.54	0.46	1.17
1	End of Growth	21	$\pi/4$	55	0.58	0.42	1.40
1	End of Growth	22	$\pi/4$	70	0.58	0.42	1.38
1	End of Growth	23	$\pi/4$	85	0.22	0.78	0.28
1	End of Growth	24	$\pi/4$	100	0.44	0.56	0.78
1	End of Growth	25	$\pi/4$	115	0.51	0.49	1.04
1	End of Growth	26	$\pi/4$	130	0.54	0.46	1.15
1	End of Growth	28	$5\pi/16$	25	0.46	0.54	0.85
1	End of Growth	30	$5\pi/16$	55	0.71	0.29	2.41
1	End of Growth	31	$5\pi/16$	70	0.62	0.38	1.62
1	End of Growth	32	$5\pi/16$	85	0.57	0.43	1.35
1	End of Growth	33	$5\pi/16$	100	0.52	0.48	1.10
1	End of Growth	34	$5\pi/16$	115	0.53	0.47	1.11



Run #	Phase	Sample #	$\theta$	r (cm)	% > 74 $\mu$	% < 74 $\mu$	Coarse/Fine Fraction
1	End of Growth	35	$5\pi/16$	130	0.54	0.46	1.17
1	End of Growth	36	$5\pi/16$	145	0.40	0.60	0.66
1	End of Growth	37	$3\pi/8$	25	0.36	0.64	0.57
1	End of Growth	38	$3\pi/8$	40	0.55	0.45	1.20
1	End of Growth	39	$3\pi/8$	55	0.56	0.44	1.28
1	End of Growth	40	$3\pi/8$	70	0.68	0.32	2.12
1	End of Growth	41	$3\pi/8$	85	0.63	0.37	1.72
1	End of Growth	42	$3\pi/8$	100	0.57	0.43	1.32
1	End of Growth	43	$3\pi/8$	115	0.53	0.47	1.13
1	End of Growth	44	$3\pi/8$	130	0.51	0.49	1.03
1	End of Growth	45	$3\pi/8$	145	0.47	0.53	0.87
1	End of Falling	1	$\pi/8$	25	0.45	0.55	0.81
1	End of Falling	2	$\pi/8$	40	0.47	0.53	0.89
1	End of Falling	3	$\pi/8$	55	0.62	0.38	1.60
1	End of Falling	4	$\pi/8$	70	0.41	0.59	0.69
1	End of Falling	5	$\pi/8$	85	0.38	0.62	0.60
1	End of Falling	6	$\pi/8$	100	0.37	0.63	0.59
1	End of Falling	7	$\pi/8$	115	0.40	0.60	0.67
1	End of Falling	8	$\pi/8$	130	0.33	0.67	0.50
1	End of Falling	9	$\pi/8$	145	0.60	0.40	1.50
1	End of Falling	10	$3\pi/16$	25	0.54	0.46	1.16
1	End of Falling	11	$3\pi/16$	40	0.49	0.51	0.95
1	End of Falling	12	$3\pi/16$	55	0.59	0.41	1.42
1	End of Falling	13	$3\pi/16$	70	0.31	0.69	0.44
1	End of Falling	14	$3\pi/16$	85	0.55	0.45	1.21
1	End of Falling	15	$3\pi/16$	100	0.47	0.53	0.88
1	End of Falling	16	$3\pi/16$	115	0.41	0.59	0.70
1	End of Falling	17	$3\pi/16$	130	0.38	0.62	0.62
1	End of Falling	18	$3\pi/16$	145	0.46	0.54	0.85
1	End of Falling	19	$\pi/4$	25	0.46	0.54	0.85
1	End of Falling	20	$\pi/4$	40	0.47	0.53	0.90
1	End of Falling	21	$\pi/4$	55	0.49	0.51	0.95
1	End of Falling	22	$\pi/4$	70	0.48	0.52	0.94

Run #	Phase	Sample #	$\theta$	r (cm)	% > 74 $\mu$	% < 74 $\mu$	Coarse/Fine Fraction
1	End of Falling	23	$\pi/4$	85	0.45	0.55	0.82
1	End of Falling	24	$\pi/4$	100	0.47	0.53	0.87
1	End of Falling	25	$\pi/4$	115	0.46	0.54	0.86
1	End of Falling	26	$\pi/4$	130	0.48	0.52	0.92
1	End of Falling	27	$\pi/4$	145	0.39	0.61	0.64
1	End of Falling	28	$5\pi/16$	25	0.60	0.40	1.52
1	End of Falling	29	$5\pi/16$	40	0.61	0.39	1.57
1	End of Falling	30	$5\pi/16$	55	0.52	0.48	1.09
1	End of Falling	31	$5\pi/16$	70	0.39	0.61	0.65
1	End of Falling	32	$5\pi/16$	85	0.00	1.00	0.00
1	End of Falling	33	$5\pi/16$	100	0.00	1.00	0.00
1	End of Falling	34	$5\pi/16$	115	0.47	0.53	0.90
1	End of Falling	35	$5\pi/16$	130	0.47	0.53	0.89
1	End of Falling	36	$5\pi/16$	145	0.36	0.64	0.57
1	End of Falling	37	$3\pi/8$	25	0.72	0.28	2.63
1	End of Falling	38	$3\pi/8$	40	0.71	0.29	2.49
1	End of Falling	39	$3\pi/8$	55	0.59	0.41	1.46
1	End of Falling	40	$3\pi/8$	70	0.55	0.45	1.22
1	End of Falling	41	$3\pi/8$	85	0.72	0.28	2.51
1	End of Falling	42	$3\pi/8$	100	0.69	0.31	2.19
1	End of Falling	43	$3\pi/8$	115	0.72	0.28	2.57
1	End of Falling	44	$3\pi/8$	130	0.45	0.55	0.82
1	End of Falling	45	$3\pi/8$	145	0.56	0.44	1.27
2	End of Growth	1	$\pi/8$	25	0.55	0.45	1.23
2	End of Growth	2	$\pi/8$	40	0.66	0.34	1.95
2	End of Growth	3	$\pi/8$	55	0.70	0.30	2.31
2	End of Growth	4	$\pi/8$	70	0.53	0.47	1.12
2	End of Growth	5	$\pi/8$	85	0.52	0.48	1.09
2	End of Growth	6	$\pi/8$	100	0.46	0.54	0.85
2	End of Growth	7	$\pi/8$	115	0.50	0.50	0.99
2	End of Growth	8	$\pi/8$	130	0.44	0.56	0.79
2	End of Growth	9	$\pi/8$	145	0.28	0.72	0.39
2	End of Growth	10	$3\pi/16$	25	0.64	0.36	1.78

Run #	Phase	Sample #	$\theta$	r (cm)	% > 74 $\mu$	% < 74 $\mu$	Coarse/Fine Fraction
2	End of Growth	11	$3\pi/16$	40	0.54	0.46	1.17
2	End of Growth	12	$3\pi/16$	55	0.58	0.42	1.36
2	End of Growth	13	$3\pi/16$	70	0.36	0.64	0.57
2	End of Growth	14	$3\pi/16$	85	0.37	0.63	0.59
2	End of Growth	15	$3\pi/16$	100	0.29	0.71	0.40
2	End of Growth	16	$3\pi/16$	115	0.27	0.73	0.36
2	End of Growth	17	$3\pi/16$	130	0.27	0.73	0.36
2	End of Growth	18	$3\pi/16$	145	0.57	0.43	1.33
2	End of Growth	19	$\pi/4$	25	0.57	0.43	1.33
2	End of Growth	20	$\pi/4$	40	0.53	0.47	1.15
2	End of Growth	21	$\pi/4$	55	0.46	0.54	0.85
2	End of Growth	22	$\pi/4$	70	0.44	0.56	0.77
2	End of Growth	23	$\pi/4$	85	0.31	0.69	0.44
2	End of Growth	24	$\pi/4$	100	0.30	0.70	0.43
2	End of Growth	25	$\pi/4$	115	0.42	0.58	0.71
2	End of Growth	26	$\pi/4$	130	0.25	0.75	0.34
2	End of Growth	28	$5\pi/16$	25	0.51	0.49	1.04
2	End of Growth	29	$5\pi/16$	40	0.44	0.56	0.78
2	End of Growth	30	$5\pi/16$	55	0.37	0.63	0.59
2	End of Growth	31	$5\pi/16$	70	0.36	0.64	0.55
2	End of Growth	32	$5\pi/16$	85	0.40	0.60	0.68
2	End of Growth	33	$5\pi/16$	100	0.33	0.67	0.48
2	End of Growth	34	$5\pi/16$	115	0.37	0.63	0.59
2	End of Growth	35	$5\pi/16$	130	0.16	0.84	0.19
2	End of Growth	36	$5\pi/16$	145	0.28	0.72	0.39
2	End of Growth	37	$3\pi/8$	25	0.39	0.61	0.63
2	End of Growth	38	$3\pi/8$	40	0.43	0.57	0.76
2	End of Growth	39	$3\pi/8$	55	0.49	0.51	0.95
2	End of Growth	40	$3\pi/8$	70	0.48	0.52	0.91
2	End of Growth	41	$3\pi/8$	85	0.52	0.48	1.10
2	End of Growth	42	$3\pi/8$	100	0.50	0.50	1.01
2	End of Growth	43	$3\pi/8$	115	0.49	0.51	0.97
2	End of Growth	44	$3\pi/8$	130	0.41	0.59	0.69

Run #	Phase	Sample #	$\theta$	r (cm)	% > 74 $\mu$	% < 74 $\mu$	Coarse/Fine Fraction
2	End of Growth	45	$3\pi/8$	145	0.24	0.76	0.32
2	End of Building	1	$\pi/8$	25	0.65	0.35	1.82
2	End of Building	2	$\pi/8$	40	0.51	0.49	1.05
2	End of Building	3	$\pi/8$	55	0.54	0.46	1.19
2	End of Building	4	$\pi/8$	70	0.58	0.42	1.36
2	End of Building	5	$\pi/8$	85	0.46	0.54	0.86
2	End of Building	6	$\pi/8$	100	0.46	0.54	0.85
2	End of Building	7	$\pi/8$	115	0.48	0.52	0.92
2	End of Building	8	$\pi/8$	130	0.33	0.67	0.50
2	End of Building	9	$\pi/8$	145	0.40	0.60	0.67
2	End of Building	10	$3\pi/16$	25	0.45	0.55	0.82
2	End of Building	11	$3\pi/16$	40	0.40	0.60	0.67
2	End of Building	12	$3\pi/16$	55	0.51	0.49	1.06
2	End of Building	13	$3\pi/16$	70	0.36	0.64	0.56
2	End of Building	14	$3\pi/16$	85	0.35	0.65	0.54
2	End of Building	15	$3\pi/16$	100	0.39	0.61	0.63
2	End of Building	16	$3\pi/16$	115	0.38	0.62	0.62
2	End of Building	17	$3\pi/16$	130	0.40	0.60	0.65
2	End of Building	18	$3\pi/16$	145	0.47	0.53	0.88
2	End of Building	19	$\pi/4$	25	0.43	0.57	0.76
2	End of Building	20	$\pi/4$	40	0.42	0.58	0.72
2	End of Building	21	$\pi/4$	55	0.40	0.60	0.66
2	End of Building	22	$\pi/4$	70	0.41	0.59	0.70
2	End of Building	23	$\pi/4$	85	0.64	0.36	1.74
2	End of Building	24	$\pi/4$	100	0.45	0.55	0.81
2	End of Building	25	$\pi/4$	115	0.44	0.56	0.78
2	End of Building	26	$\pi/4$	130	0.16	0.84	0.19
2	End of Building	27	$\pi/4$	145	0.46	0.54	0.86
2	End of Building	28	$5\pi/16$	25	0.66	0.34	1.92
2	End of Building	29	$5\pi/16$	40	0.65	0.35	1.88
2	End of Building	30	$5\pi/16$	55	0.54	0.46	1.20
2	End of Building	31	$5\pi/16$	70	0.40	0.60	0.66
2	End of Building	32	$5\pi/16$	85	0.46	0.54	0.84

Run #	Phase	Sample #	$\theta$	r (cm)	% > 74 $\mu$	% < 74 $\mu$	Coarse/Fine Fraction
2	End of Building	33	$5\pi/16$	100	0.37	0.63	0.59
2	End of Building	34	$5\pi/16$	115	0.43	0.57	0.77
2	End of Building	35	$5\pi/16$	130	0.49	0.51	0.96
2	End of Building	36	$5\pi/16$	145	0.49	0.51	0.95
2	End of Building	37	$3\pi/8$	25	0.61	0.39	1.53
2	End of Building	38	$3\pi/8$	40	0.54	0.46	1.18
2	End of Building	39	$3\pi/8$	55	0.46	0.54	0.85
2	End of Building	40	$3\pi/8$	70	0.54	0.46	1.15
2	End of Building	44	$3\pi/8$	130	0.42	0.58	0.73
2	End of Building	45	$3\pi/8$	145	0.33	0.67	0.50
2	End of Falling	1	$\pi/8$	25	0.67	0.33	2.01
2	End of Falling	2	$\pi/8$	40	0.60	0.40	1.48
2	End of Falling	3	$\pi/8$	55	0.69	0.31	2.25
2	End of Falling	4	$\pi/8$	70	0.63	0.37	1.72
2	End of Falling	5	$\pi/8$	85	0.58	0.42	1.37
2	End of Falling	6	$\pi/8$	100	0.49	0.51	0.96
2	End of Falling	7	$\pi/8$	115	0.51	0.49	1.06
2	End of Falling	8	$\pi/8$	130	0.49	0.51	0.94
2	End of Falling	9	$\pi/8$	145	0.65	0.35	1.83
2	End of Falling	10	$3\pi/16$	25	0.68	0.32	2.17
2	End of Falling	11	$3\pi/16$	40	0.49	0.51	0.98
2	End of Falling	12	$3\pi/16$	55	0.46	0.54	0.86
2	End of Falling	13	$3\pi/16$	70	0.46	0.54	0.86
2	End of Falling	14	$3\pi/16$	85	0.42	0.58	0.71
2	End of Falling	15	$3\pi/16$	100	0.43	0.57	0.76
2	End of Falling	16	$3\pi/16$	115	0.42	0.58	0.72
2	End of Falling	17	$3\pi/16$	130	0.45	0.55	0.81
2	End of Falling	18	$3\pi/16$	145	0.44	0.56	0.77
2	End of Falling	19	$\pi/4$	25	0.58	0.42	1.37
2	End of Falling	20	$\pi/4$	40	0.43	0.57	0.76
2	End of Falling	21	$\pi/4$	55	0.52	0.48	1.06
2	End of Falling	22	$\pi/4$	70	0.39	0.61	0.63
2	End of Falling	23	$\pi/4$	85	0.42	0.58	0.73

Run #	Phase	Sample #	$\theta$	r (cm)	% > 74 $\mu$	% < 74 $\mu$	Coarse/Fine Fraction
2	End of Falling	24	$\pi/4$	100	0.53	0.47	1.12
2	End of Falling	25	$\pi/4$	115	0.43	0.57	0.77
2	End of Falling	26	$\pi/4$	130	0.37	0.63	0.60
2	End of Falling	27	$\pi/4$	145	0.38	0.62	0.61
2	End of Falling	28	$5\pi/16$	25	0.53	0.47	1.13
2	End of Falling	29	$5\pi/16$	40	0.49	0.51	0.97
2	End of Falling	30	$5\pi/16$	55	0.58	0.42	1.40
2	End of Falling	31	$5\pi/16$	70	0.50	0.50	1.01
2	End of Falling	32	$5\pi/16$	85	0.46	0.54	0.85
2	End of Falling	33	$5\pi/16$	100	0.47	0.53	0.88
2	End of Falling	34	$5\pi/16$	115	0.41	0.59	0.70
2	End of Falling	35	$5\pi/16$	130	0.55	0.45	1.23
2	End of Falling	36	$5\pi/16$	145	0.58	0.42	1.36
2	End of Falling	37	$3\pi/8$	25	0.61	0.39	1.59
2	End of Falling	38	$3\pi/8$	40	0.58	0.42	1.39
2	End of Falling	39	$3\pi/8$	55	0.65	0.35	1.83
2	End of Falling	40	$3\pi/8$	70	0.41	0.59	0.70
2	End of Falling	41	$3\pi/8$	85	0.39	0.61	0.65
2	End of Falling	42	$3\pi/8$	100	0.30	0.70	0.44
2	End of Falling	43	$3\pi/8$	115	0.51	0.49	1.04
2	End of Falling	44	$3\pi/8$	130	0.59	0.41	1.44
2	End of Falling	45	$3\pi/8$	145	0.31	0.69	0.45

## Appendix C – Comparison of Grain Size Distribution by Volume (Horiba® Laser Diffraction) and by Weight (Sieve and Hydrometer Tests from SET Labs)

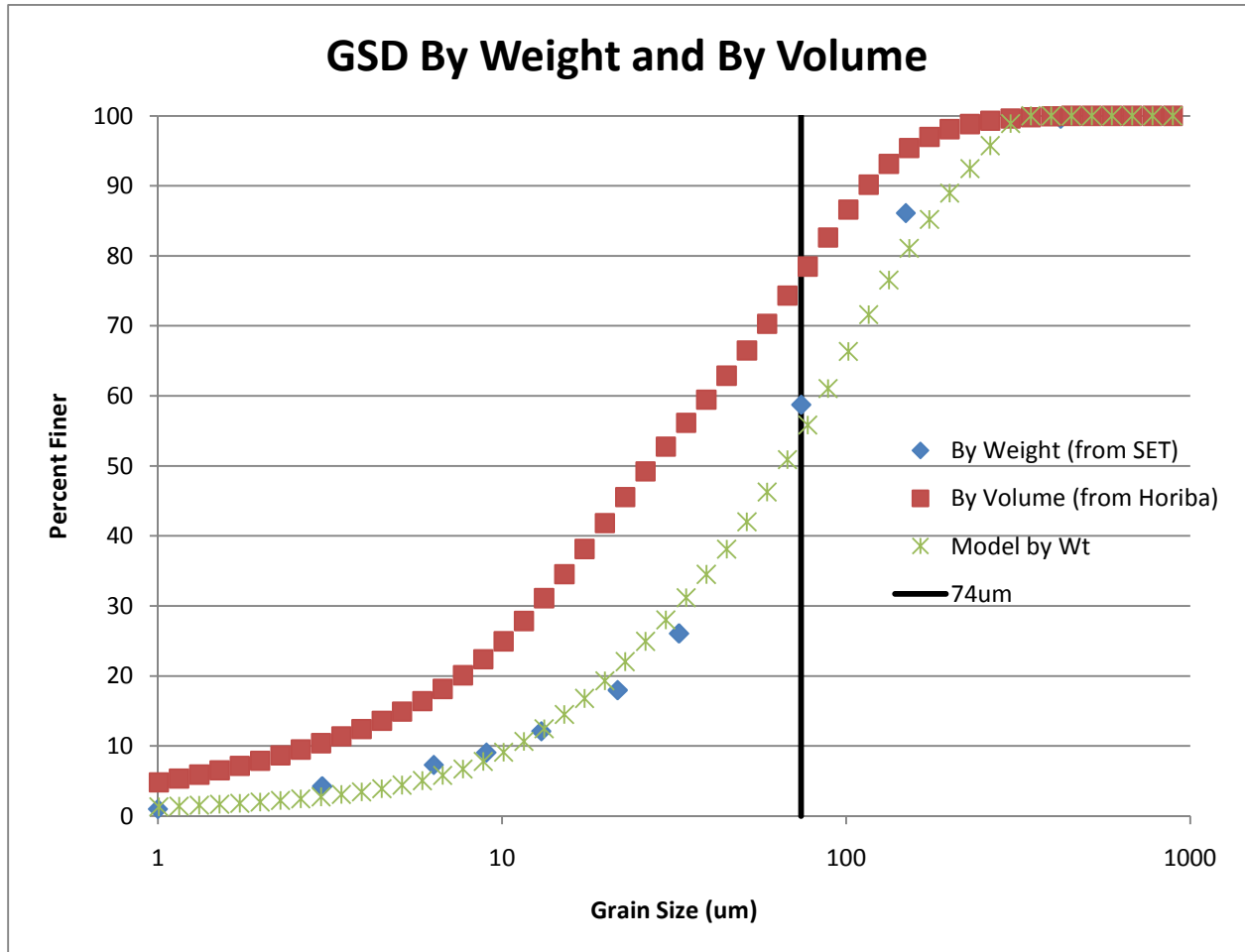

The percent finer by weight can be estimated using the following equation:

$$\%Finer_W = \%Finer_V \cdot F \cdot [A \cdot \ln(C \cdot Dia + E) + B] + G$$

Where:  $\%Finer_W$  = Percent finer by weight

$\%Finer_V$  = Percent Finer by volume

Dia = Particle diameter (um)

A = 0.214826

B = -0.21006

C = 0.83509

E = 4.470231

F = 1.006547

G = 0.574739

## **Appendix D – Videos**

See supplemental CD or attached video files for Phase I video and Phase II 20-second time laps aerial videos of each run.

CONFIDENTIAL



**Attachment F**

**Update on Tailings Humidity Cell Test Data**

## Memo

---

<b>To:</b>	Peter Hinck	<b>Date:</b>	December 23, 2011
<b>Company:</b>	Barr	<b>From:</b>	Laura Donkervoort Stephen Day
<b>Copy to:</b>	Jim Scott, PolyMet	<b>Project #:</b>	1UP005.001
<b>Subject:</b>	Update on Tailings Humidity Cell Test Data, NorthMet Project – DRAFT		

---

### 1 Introduction

Kinetic geochemical testing of samples of tailings produced by pilot plant processing of NorthMet Project ores began in 2005 when the first process testing occurred. Subsequently, PolyMet has repeated similar pilot plant testing three times to optimize the flotation process and evaluate recovery of concentrate for different ore composites. Each time a pilot plant was operated, the resulting tailings samples have been submitted for the same geochemical test procedures including solids analysis for sulfur and trace element content and kinetic testing on whole samples and size fractions.

Fundamentally, the flowsheet of the flotation process has not changed except for copper sulfate not being used in the very first runs of Pilot Plant 1. Due to the improvement in recovery of sulfide minerals (and consequent reduction in sulfide content of tailings), copper sulfate has been used in all subsequent pilot plants. As a result, it is appropriate to consider all tailings results as a single dataset rather than individual datasets for each pilot plant run.

Separate tailings testwork has been initiated on four samples of LTVSMC tailings which will be used for construction of tailings embankments. As these tests are being performed on completely different materials, they are described separately at the end of this memorandum.

The purpose of the memorandum is to provide an update on tailings humidity cell data and their influence on inputs to water quality prediction models. A previous update (RS82 - Update on Use of Kinetic Test Data for Water Quality Predictions, February 2, 2009) was prepared with approximately 3 years data from NorthMet Project pilot plant samples generated in 2005 and 2006. Since that time, an additional three years of data have been collected for these tests and two additional data sets have been generated from tailings produced by the two additional pilot plants run in 2008 and 2009.

Due to the change in conceptualization of the overall modeling approach from the use of metal to sulfate ratios of release rates to the use mainly of sulfate release rates and metal to sulfur ratios in solids to predict pore water chemistry, this update report focuses mainly on a comparison of trends in pH and sulfate between the tests.

## **2 NorthMet Project Tailings Kinetic Tests**

### **2.1 Status of Program**

Table 1 lists all tailings humidity cells. The test program consists of conventional humidity cells with parallel tests using the MDNR reactor configuration on bulk tailings and tailings size fractions. All cells are currently running smoothly however, some repairs have occurred in addition to those stated in the RS82 report.

The filter fabrics in T55 and T62 humidity cells were found to be torn and allowing the breakthrough of solids into the leachate collection chamber. The cells were dismantled and repaired in September 2009. All solids were recovered and returned to the respective cells. Following these repairs, leachate chemistry re-stabilized within 2 weeks, returning to pre-repair levels. Arsenic levels were slower to decline, taking 7 weeks to return to pre-repair levels. This type of occurrence has been previously observed in the RS82 report.

All tests originally started are continuing and none of the tests have been terminated. Laboratory and analytical methods are unchanged from that developed in consultation with the MDNR and are consistent between all tests included in this update report.

**Table 1: Tailings Humidity Cells Used as Basis for Update Report**

HCT ID	Fraction	HCT Full ID	Total Sulfur %	Initial Start Date	Total Weeks
T1	Whole	P1 (CuSO4)	0.1	9/8/2005	304
T2	Whole	P1 (no CuSO4)	0.23	9/8/2005	304
T3	Whole	P2 (no CuSO4)	0.2	9/8/2005	304
T4	Whole	P3 (CuSO4)	0.15	9/8/2005	304
T5	+100	Parcel 2 P2S +100 mesh	0.15	2/10/2006	282
T6	-100+200	Parcel 2 P2S -100 +200 mesh	0.17	2/10/2006	282
T7	-200	Parcel 2 P2S -200 mesh	0.24	2/10/2006	282
T8	+100	Parcel 1-2 PISCS +100 mesh	0.11	2/10/2006	282
T9	-100+200	Parcel 1-2 PISCS -100 +200 mesh	0.1	2/10/2006	282
T10	-200	Parcel 1-2 PISCS -200 mesh	0.09	2/10/2006	282
T11	+100	Parcel 3 P3S +100 mesh	0.11	2/10/2006	282
T12	-100+200	Parcel 3 P3S -100 +200 mesh	0.14	2/10/2006	282
T13	-200	Parcel 3 P3S -200 mesh	0.14	2/10/2006	282
T52	Whole	Pilot Plant 2 (0.30 Cu feed) Composite Bulk Tailings (as received)	0.07	7/8/2008	156
T53	+100	Pilot Plant 2 (0.30 Cu feed) Composite (+100 mesh)	0.08	7/8/2008	156
T54	-100+200	Pilot Plant 2 (0.30 Cu feed) Composite (-100 + 200 mesh)	0.06	7/8/2008	156
T55	-200	Pilot Plant 2 (0.30 Cu feed) Composite (-200 mesh)	0.09	7/8/2008	156
T56	Whole	Pilot Plant 3 (0.25 Cu feed) Composite Bulk Tailings (as received)	0.08	7/8/2008	156
T57	+100	Pilot Plant 3 (0.25 Cu feed) Composite (+100 mesh)	0.1	7/8/2008	156
T58	-100+200	Pilot Plant 3 (0.25 Cu feed) Composite (-100 + 200 mesh)	0.08	7/8/2008	156
T59	-200	Pilot Plant 3 (0.25 Cu feed) Composite (-200 mesh)	0.08	7/8/2008	156
T60	Whole	SCAV TAILS 9/30/09 1600	0.09	11/24/2009	84
T61	+100	SCAV TAILS 9/30/09 1600 +100	0.1	11/24/2009	84
T62	-100+200	SCAV TAILS 9/30/09 1600 -100+200	0.09	11/24/2009	84
T63	-200	SCAV TAILS 9/30/09 1600 -200	0.11	11/24/2009	84
T64	Whole	SCAV TAILS 10/1/09 09.00	0.13	11/24/2009	84
T65	+100	SCAV TAILS 10/1/09 09.00 +100	0.11	11/24/2009	84
T66	-100+200	SCAV TAILS 10/1/09 09.00 -100+200	0.14	11/24/2009	84
T67	-200	SCAV TAILS 10/1/09 09.00 -200	0.14	11/24/2009	84
T68	Whole	SCAV TAILS 10/1/09 17.00	0.12	11/24/2009	84
T69	+100	SCAV TAILS 10/1/09 17.00 +100	0.1	11/24/2009	84
T70	-100+200	SCAV TAILS 10/1/09 17.00 -100+200	0.1	11/24/2009	84
T71	-200	SCAV TAILS 10/1/09 17.00 -200	0.13	11/24/2009	84

## 2.2 Comparison of Solids Data

Solids data was compared between the three sets of humidity cells, (those initiated in 2005 & 2006, 2008 and 2009). Figure 1 shows the minimum, average and maximum values for key parameters.

Sulfur concentrations showed the greatest range in the early dataset due to evaluation of the use of copper sulfate to optimize recovery of sulfide minerals by flotation. Subsequent pilot plants have used copper sulfate. Metal concentrations were very similar between the three data sets with the exception of copper, which showed slightly higher average and maximum values in the cells initiated 2005 and 2006.

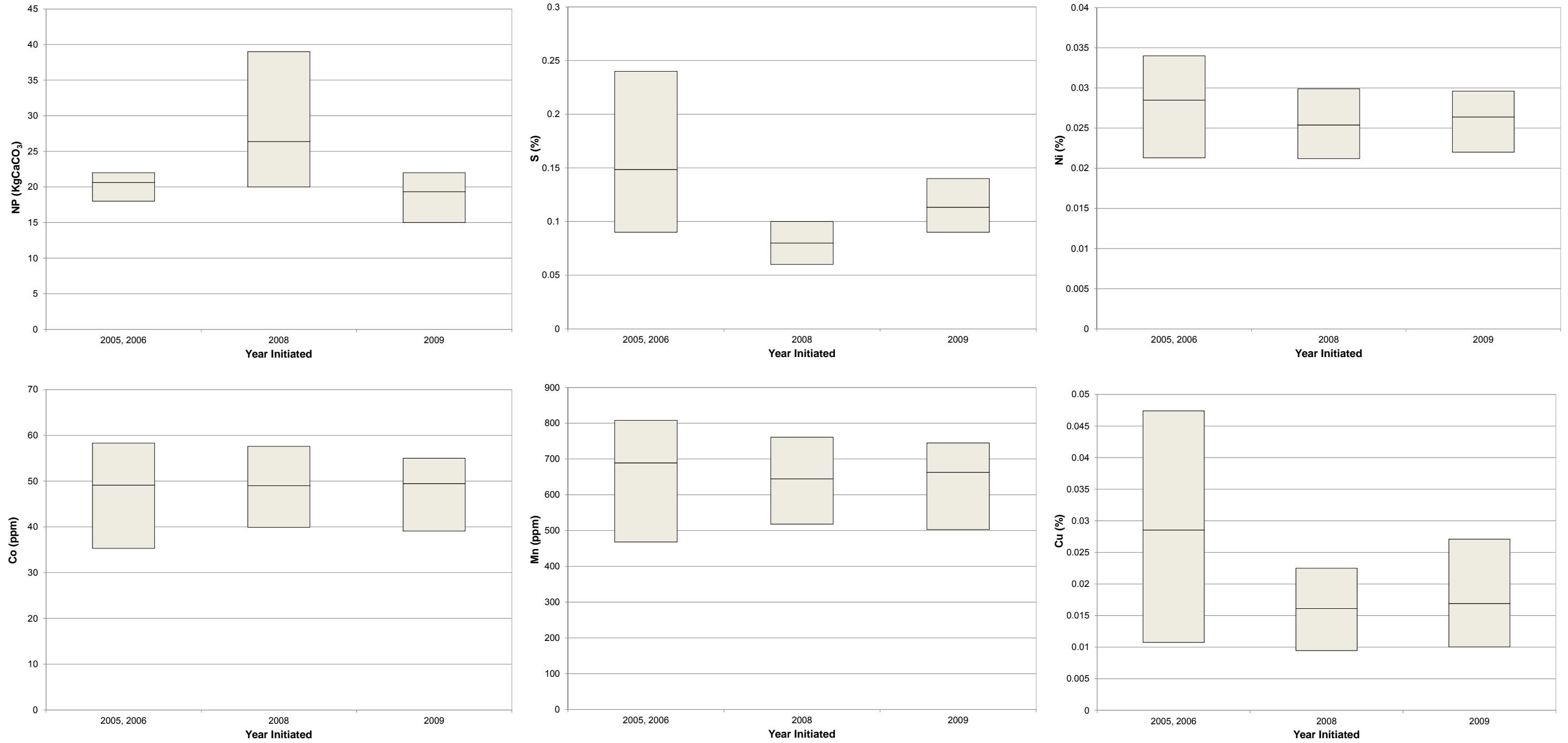

Source: G:\PolyMet Mining\1UP005.01\_Northmet\_project\_2004\Reports\2011-10\_Tailings\_Update\Re-Issue\HCT\_Static\_Compare\_1UP005.01\_Id\_rev00.xlsx

**Figure 1: Comparison of Solids data using Minimum, Average and Maximum Values – Key Results**

## 2.3 Description of Humidity Cell Results

### 2.3.1 Tests Started in 2005 & 2006

All humidity cell tests showed an initial decline in pH (Figure 2). The decline was greatest for the two coarser particles size fractions and least for the -200 mesh fraction samples. The trend for bulk tailings was between the coarse and fine fractions. The range in leachate pHs following the main initial decline was 6.0 to 7.8. Leachate pHs remain somewhat erratic but no decline to lower pHs has been apparent and pH appears to be stabilizing with time. Variation reflects whether copper sulfate was used in the pilot mineral processing circuit to improve recovery of sulfide minerals during flotation. Higher pH leachates are generally associated with samples with lower sulfur contents produced by the use of copper sulfate.

Sulfate release has shown a decline from week zero to 200. After week 200, sulfate release has generally stabilized (Figure 2). Major ions have followed sulfate and were generally decreasing followed by stabilization after week 200. Alkalinity leaching from the two coarser particle sizes declined sharply and then stabilized, with the stable period starting at approximately week 75. In contrast, alkalinity from the -200 mesh samples continued to decline until stabilization at approximately week 125. Bulk tailings with higher sulfur contents have shown the similar trends to the two coarser particle sizes whereas bulk tailings with lower sulfur contents were closer to the -200 mesh samples with all bulk tailings samples having values between the coarse and fine fractions.

The main distinctive feature of leachates has been the increase in leaching of nickel (Figure 2) cobalt and manganese from the two coarse tailings fractions. This positive trend was apparent in the RS46 Draft 01 reporting period and was confirmed by the RS82 report. Since the RS82 report leachates have shown a decrease in these metals following their peak leaching rates at approximately week 100. However, values remain elevated relative to the fine size fraction and bulk samples. In addition, an increase in leaching of these metals in bulk samples was observed at approximately week 140 followed by a general decline but at an order of magnitude below the comparable coarse fraction samples. Copper leaching rates are stable at low values (<0.002 mg/kg/week).

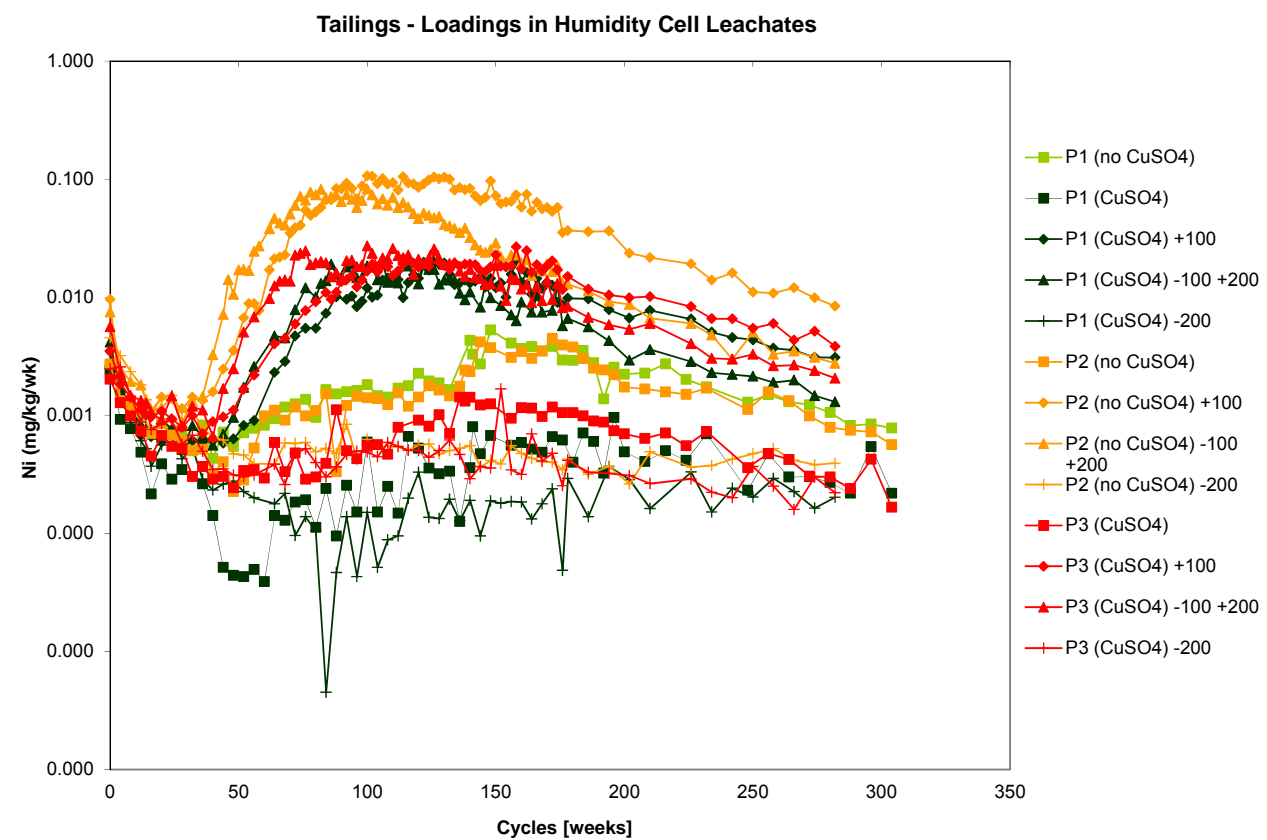
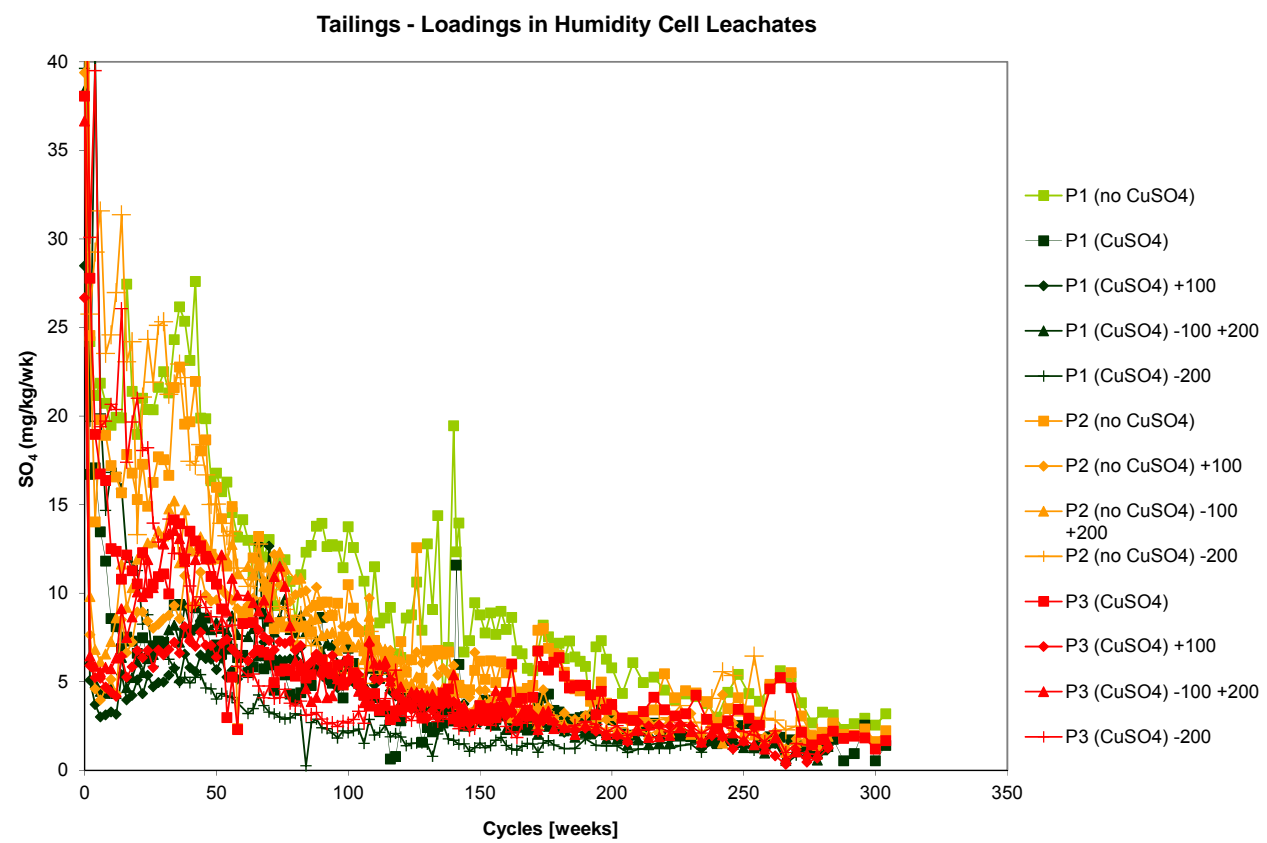
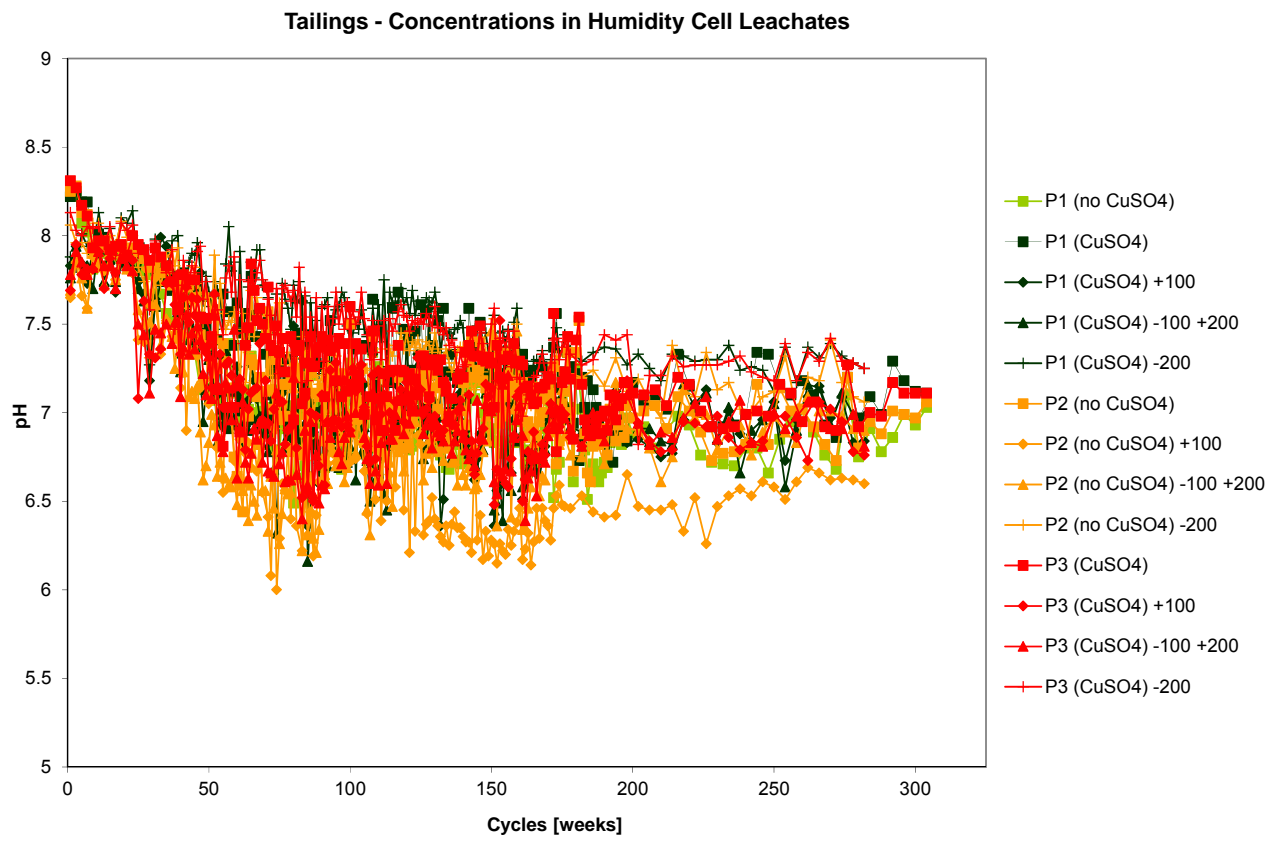

Source: \\VAN-SVR0\GE\_Projects\PolyMetMining\1UP005.01\_Northmet\_project\_2004\Testwork\Tailings\3.KineticTests\Results\Charts\loadings\_Tailings.xls

**Figure 2: Leachate pH, Sulfate and Nickel Loadings for 2005 & 2006 NorthMet Project Tailings**



### 2.3.2 Tests Started in 2008

All humidity cell tests showed a slight initial decline in pH (Figure 3). The typical range in leachate pHs following the main initial decline was 7.25 to 7.78. pH does not appear to be related to fraction size as all pH measurements fluctuate in range of values. Leachate pHs remain somewhat erratic but no decline to lower pHs has been apparent, pH appears to be stabilizing with time.

Sulfate release initially declined sharply followed by a gradual decline (Figure 3). Major ions have followed sulfate but with calcium having a larger declining trend. Alkalinity has shown a consistent decreasing trend and is highest in the coarse particle size (+100) and lowest in the medium (+100-200) particle size.

For all fraction sizes, nickel showed an initial decline until week 80 at which time nickel release increased slightly and stabilized at levels slightly above the lowest release rates (Figure 3). The exception to this is the +100 mesh samples which showed an increase in nickel release at weeks 80 to 140 followed by a decrease to the lowest values of the test period. Copper release rates were more erratic but remained at low levels throughout the testing period in the range of 0.0002 mg/kg/week to 0.002 mg/kg/week.

Results from these tests are distinctively different from the similar tests started in 2005 and 2006. Leachate pHs have not decreased to the same degree when comparing the same test period (first three years). As a result, accompanying order-of-magnitude increases in nickel concentrations have not been observed. Sulfate release for the 2008 tests also stabilized earlier.

### 2.3.3 Tests Started in 2009

All humidity cell tests showed generally stable pH (Figure 4). However, a slight decline has occurred after 50 weeks of measurement in the -100 +200 mesh samples. The general trend is highest pHs are reported for the fine fraction and lowest for the -100 +200 mesh fraction with bulk tailings measurements between the coarse and fine fractions. The range in leachate pHs was 7.1 to 8.0.

Sulfate release initially declined sharply followed by a gradual decline (Figure 4). Major ions have followed sulfate but show a larger declining trend. Alkalinity showed an initial stable period from weeks 4 to 36 followed by a declining trend. This trend is most apparent in the coarse fraction.

The slight pH decrease at week 50 in the -200 +100 mesh tailings fractions was also accompanied by a slight rise in nickel (Figure 4), cobalt and manganese release rates. All other size fractions have shown stable or decreasing release rates. Copper release rates have remained low for all cells throughout the test period in the range of 0.0001 mg/kg/week to 0.001 mg/kg/week.

Pilot Plant - Loadings in ASTM HCT

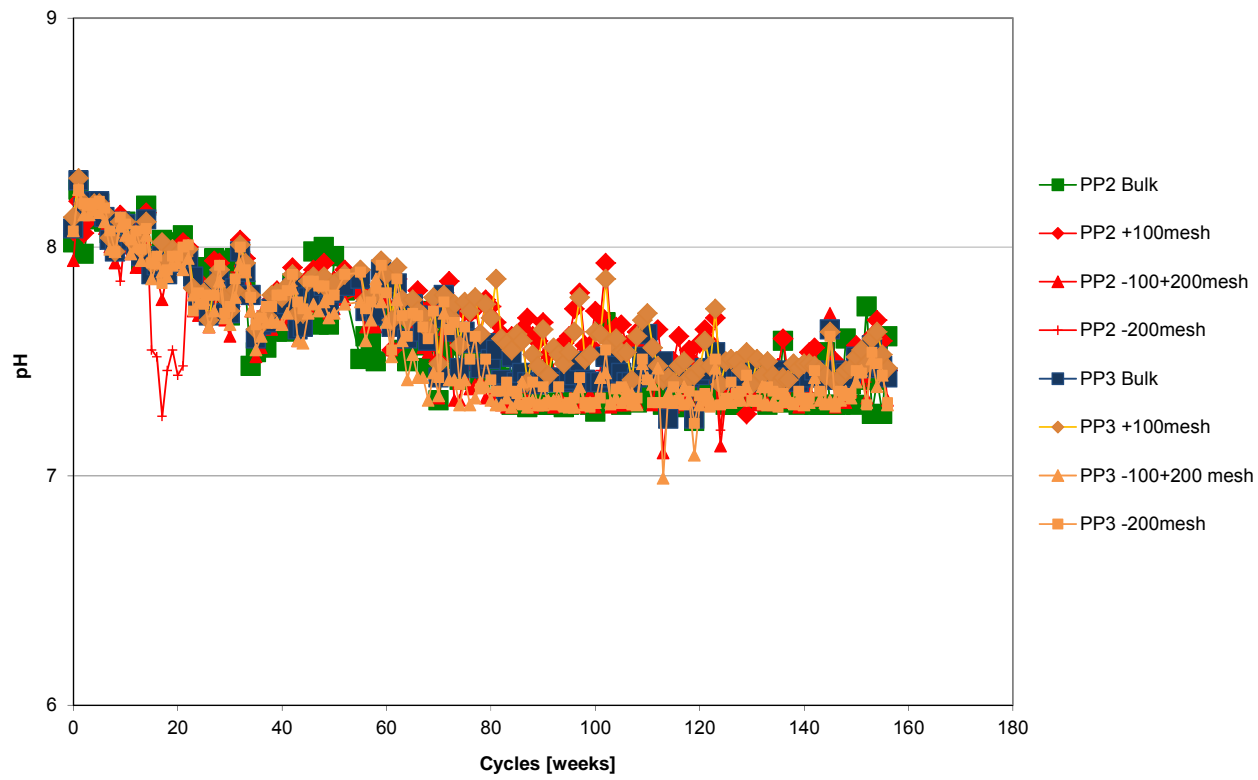

Pilot Plant - Loadings in ASTM HCT

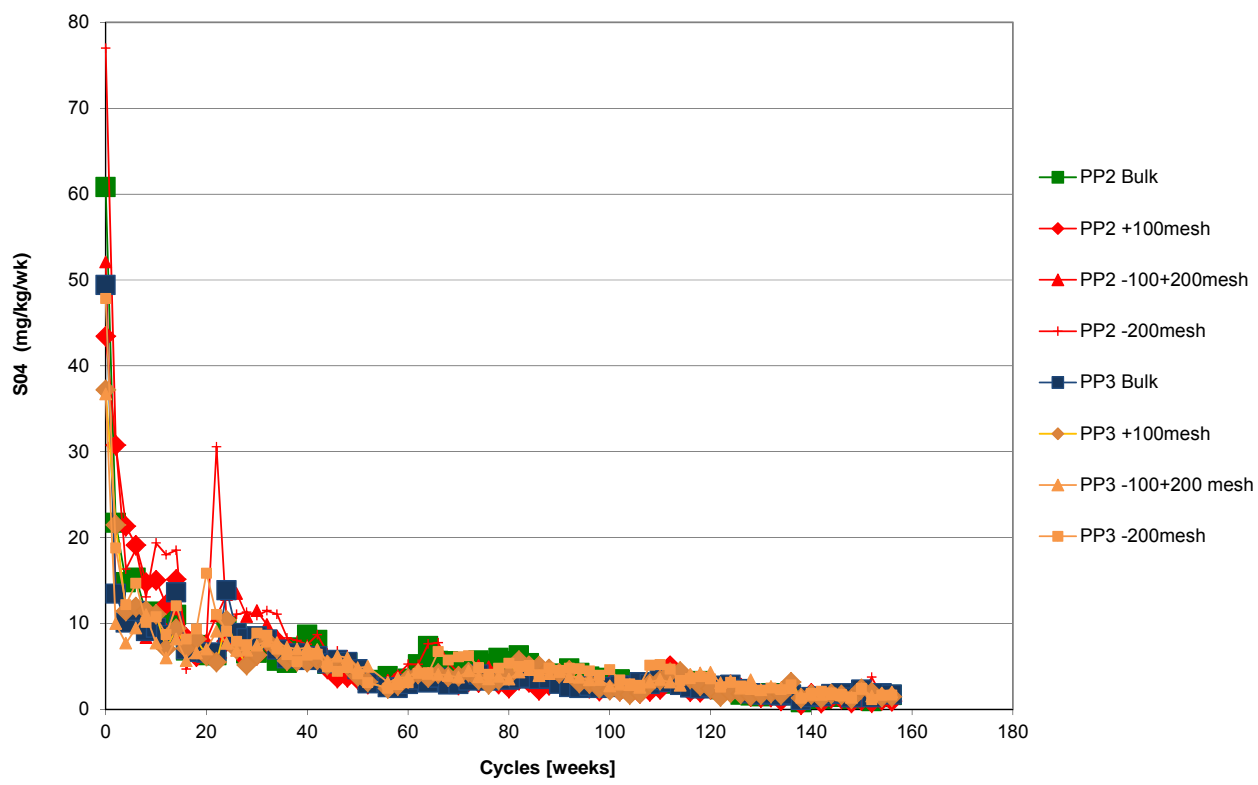

Pilot Plant - Loadings in ASTM HCT

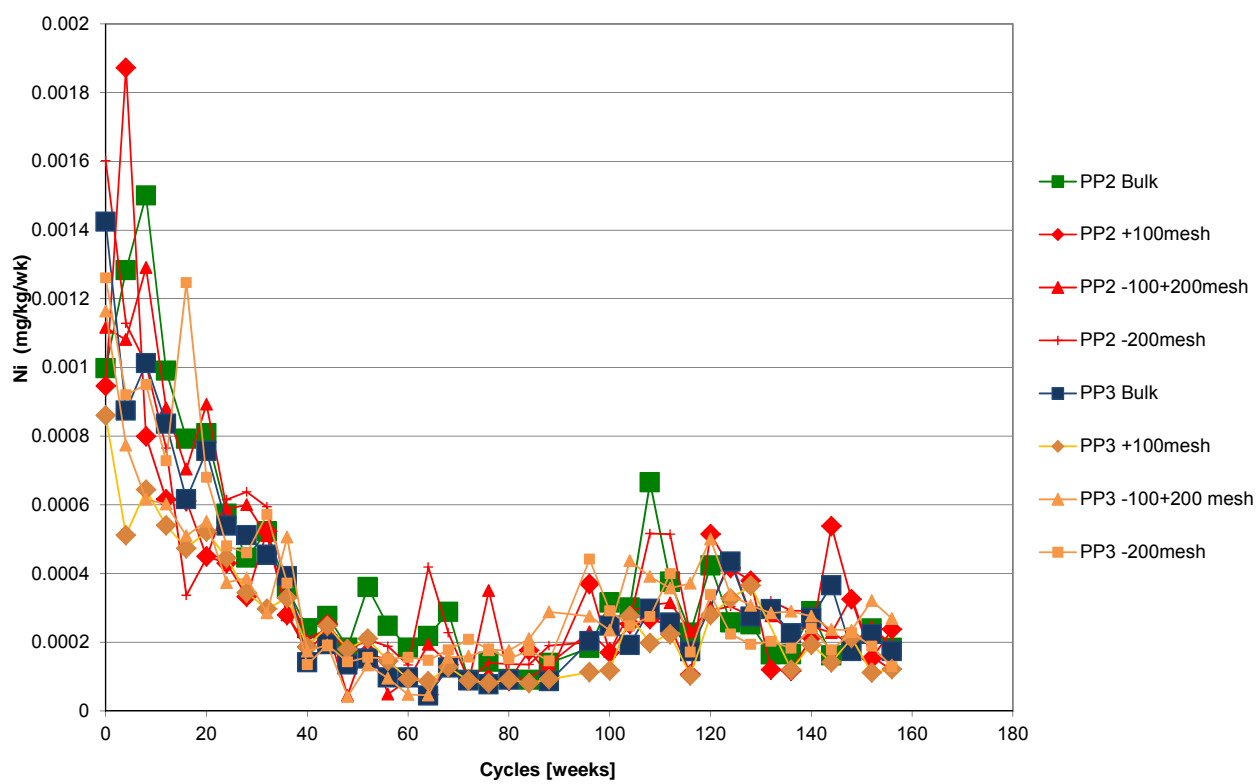

Source: \\VAN-SVR0\GE\_Projects\PolyMet Mining\1UP005.01\_Northmet\_project\_2004\Testwork\Tailings\3.KineticTests\Results\Charts\load\_PP2PP3\_Tailings.xls

Figure 3: Leachate pH, Sulfate and Nickel Loadings for NorthMet 2008 Pilot Plant

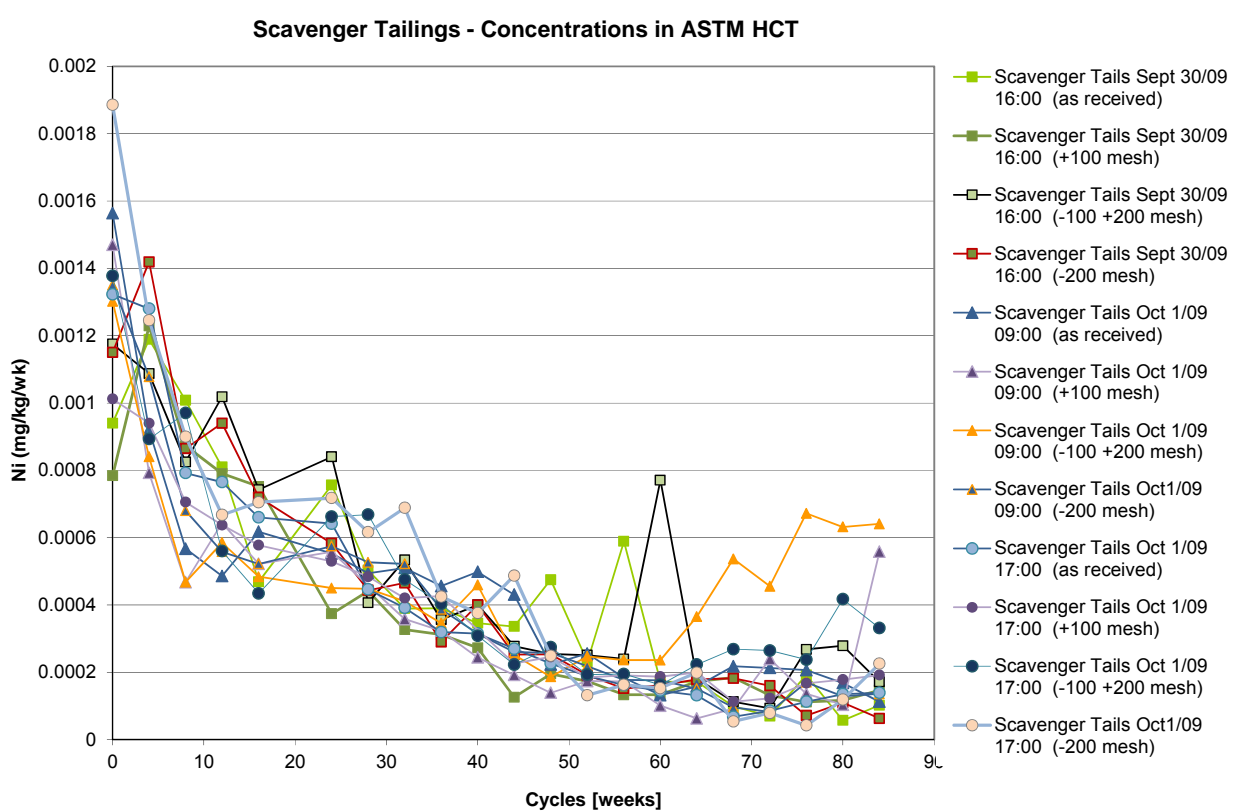
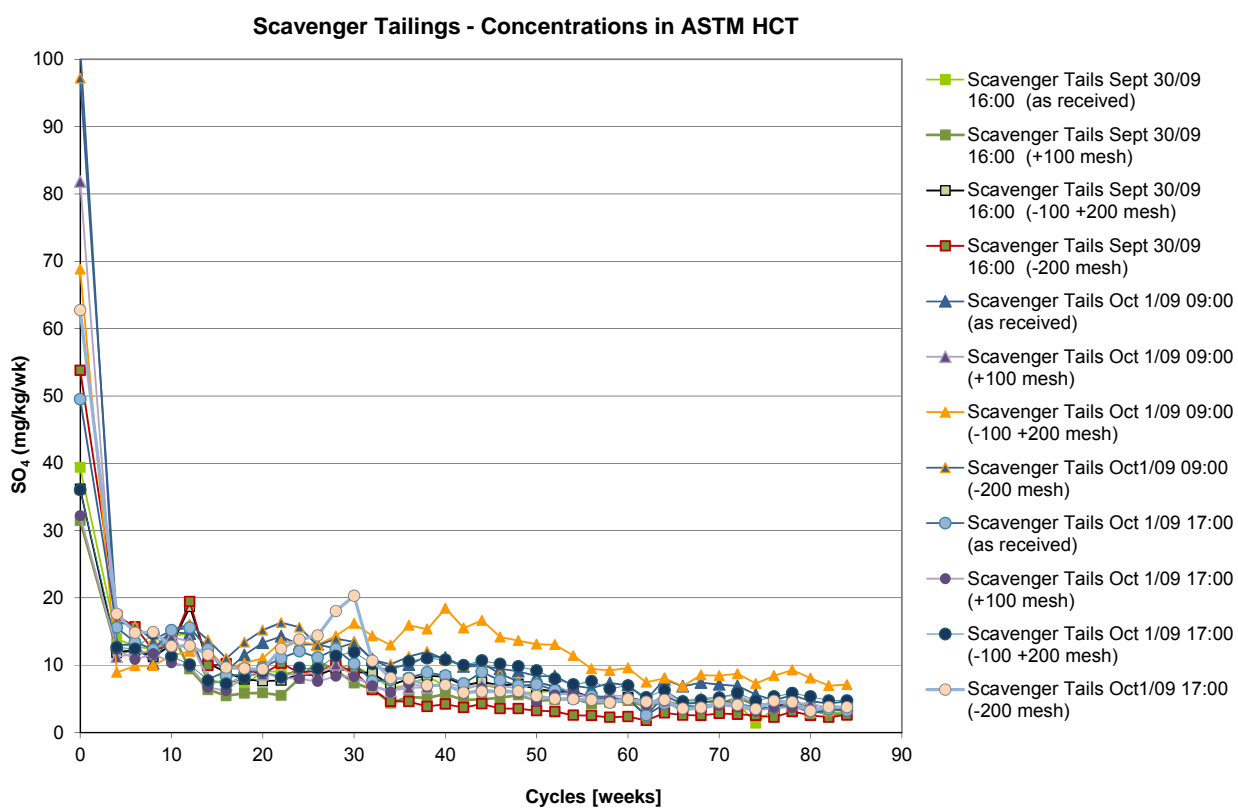
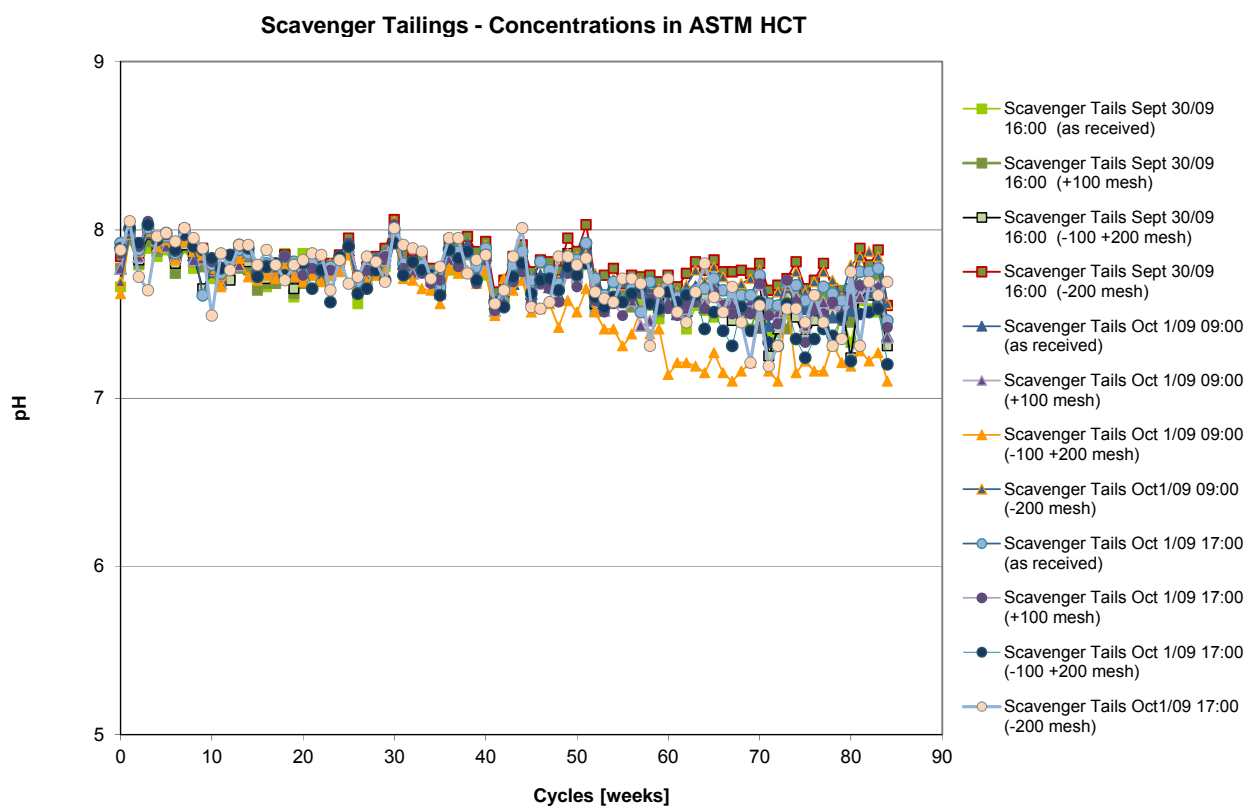

Source: \\VAN-SVR0\GE\_Projects\PolyMet Mining\1UP005.01\_Northmet\_project\_2004\Testwork\Tailings\3.KineticTests\Results\Charts\Loadings\_Scavenger Tailings\_Tailings.xlsx

**Figure 4: Leachate pH, Sulfate and Nickel Loadings for NorthMet 2009 Scavenger Tailings**

## 2.4 Discussion

The primary inputs to water quality modeling for the tailings are sulfide oxidation rates indicated by sulfate release from humidity cells. For the purpose of modeling, the sulfide oxidation reaction is assumed to be zero order, that is, the oxidation rate is independent of the amount of reactant (sulfide) remaining. This assumption was adopted to simplify the implementation of sulfide oxidation in the tailings water quality model and is conservative from the standpoint of estimating maximum expected concentrations of sulfate and other parameters. The current extended dataset provides an opportunity to evaluate the assumption and compare tailings produce by several metallurgical test programs.

Figure 5 shows sulfate release for all whole tailings samples being tested. Lines on the graph show the three different programs as different symbols and color-coding illustrates different initial sulfur concentrations. Sulfur concentrations exceeding 0.2% are shown as red; concentrations between 0.1 and 0.2% are shown as amber; and concentrations less than 0.1% are shown in green.

The overall distribution of rates shows that oxidation rates are correlated with sulfur content. Highest rates are associated with higher initial sulfur concentrations, and lowest rates are shown by samples with lowest sulfur concentrations.

Samples with sulfur concentrations exceeding 0.2% were only generated in the first pilot plant run when copper sulfate was not used at first to improve sulfide mineral flotation. Comparison between programs for the middle and lower sulfur ranges shows that there is little difference between results from the programs. In the middle sulfur range, oxidation rates for the initial pilot plant run samples were slightly higher than those in the same range produced in 2009, but the 2009 samples also had slightly lower initial sulfur concentrations. The same effect is seen in the lower sulfur range. The first pilot plant sample had the highest concentration of the four samples in this range and it appears yielded the highest sulfate release rates in that sulfur range. As a group, the testwork performed at various times shows similar relationships between sulfur content and sulfate release.

All tests showed that sulfate release declined over time. Mass balance indicates that the first and second sample set have been depleted of between 30% and 40% of the initial sulfur content indicating that the decline in sulfate release may be due to reduction in available oxidation rates. This implies the sulfide oxidation reaction is non-zero order and that the use of initial oxidation rates in modeling remains conservative.

Differences in pH trends and consequent release of nickel have been observed in the testwork. The initial dataset showed that pH decreased to a level at which nickel release could increase due to increased solubility of secondary nickel. This trend has not been observed to the same degree in subsequent testwork. The strong sensitivity of the test procedures to pH buffering by silicate mineral weathering has been observed previously and may be the reason for the observed differences. The 2008 tests suggest the tailings have greater buffering capacity than the 2005/2006 tests. Use of the first dataset to define sulfur concentrations which could result in significant metal leaching due to pH depression that could occur appears to be conservative.

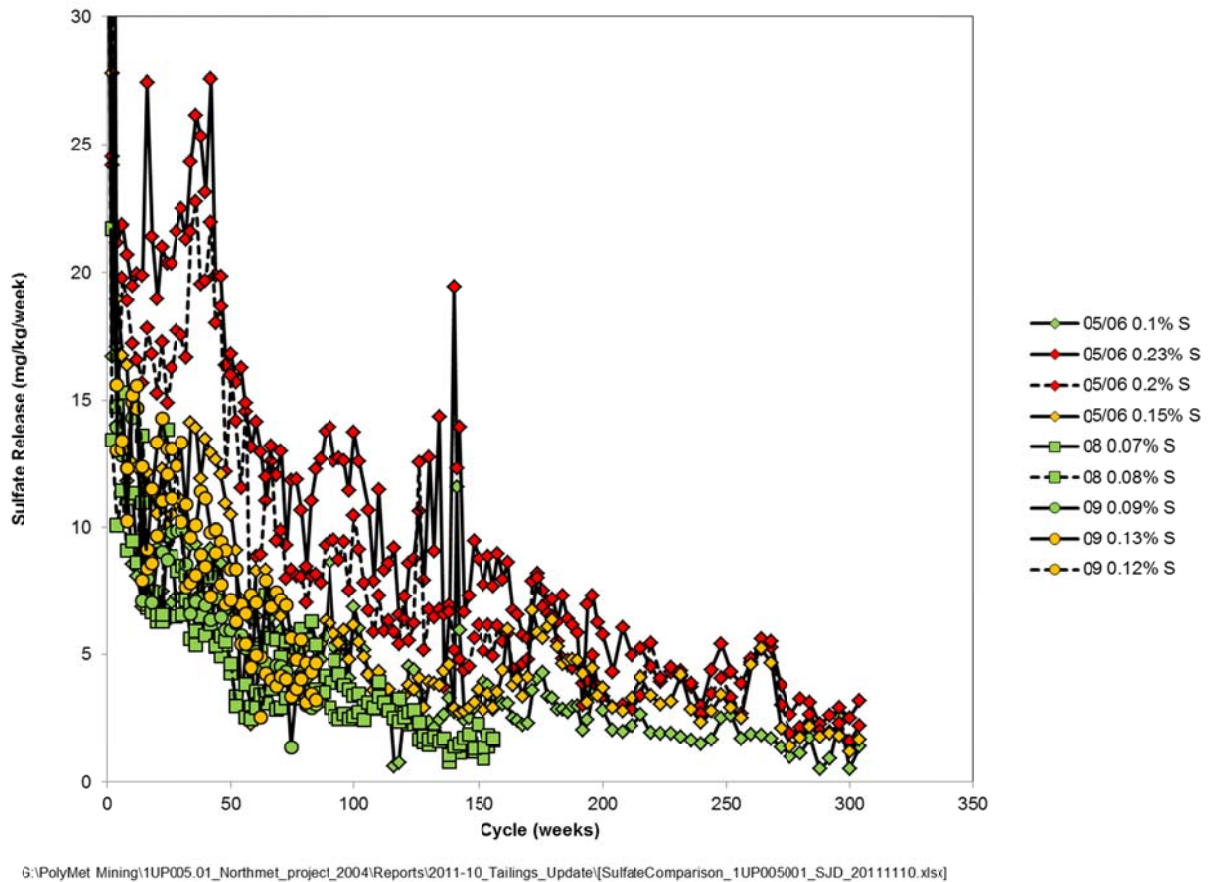

**Figure 5: Comparison of Sulfate Leaching Rates as a Function of Sulfur Content**

## 2.5 Conclusions

Review of ongoing and new humidity cell data shows that the assumptions used for oxidation rates in the water quality modelling are conservative when assuming the reaction order for sulfide oxidation, and that oxidation rates shown by tailings produced at different times are comparable.

Differences in pH trends are apparent between tailings produced by the different rounds of metallurgical testwork. However, the differences do not indicate a need to re-visit assumptions about sulfur management criteria (tailings to contain less than 0.2% sulfur). Ongoing testwork on tailings containing more than 0.2% sulfur for six years has shown stable pH as sulfur content has depleted to 40% of the starting composition.

## 3 LTVSMC Tailings Samples

### 3.1 Source of Samples

Twenty-nine samples of coarse LTVSMC tailings were obtained as part of a drilling program supervised by Barr Engineering to evaluate the geotechnical characteristics of the tailings. Ten drill holes were sampled in five different potential borrow areas (Figure 6).



**Figure 6: LTVSMC Drilling Locations**

### 3.2 Characteristics of Samples

Selected characteristics of the samples are shown in Table 2. Overall characteristics are similar to those for samples collected in an earlier drilling program and previously reported in RS46. Sulfur and trace element contents are very low. LTVSMC tailings samples are classified as non-acid generating due to the presence of carbonate minerals.

Results for the 29 samples were used to generate a sub-set of samples for humidity cell testing. In order to obtain sufficient sample for humidity cell testing (1 kg), composites were produced to represent coarse tailings in the four main borrow areas:

- 2E North Embankment
- 1E and 2E Separator
- 1E South Beach
- 2W North Embankment

Characteristics of the resulting composites are shown in Table 3. The sample from 2E North Embankment was tested in duplicate.

**Table 2: Characteristics of LTVSMC Tailings**

Statistic	As mg/kg	Co mg/kg	Cu mg/kg	Ni mg/kg	Carbonate %, C	Total S %, S
P5	14.88	5.94	5.28	2.78	0.638	<0.01
P50	25.5	7.9	7.3	4.1	1.45	0.03
P95	55.96	10.62	21.44	7.14	2.66	0.08

Source: \\Van-svr0.van.na.srk.ad\ge\_projects\PolyMet Mining\1UP005.01\_Northmet\_project\_2004\Testwork\2011-04\_LTV\_Static\_Compilation\LTV\_Static\_Compilation\_1UP005001\_SJD\_20110428.xlsx

**Table 3: Characteristics of LTVSMC Composite Tailings Samples Tested in Humidity Cells**

HCT ID	As mg/kg	Co mg/kg	Cu mg/kg	Ni mg/kg	Total S %
2E North Embankment Composite	28.7	8	7.8	4.1	0.03
2E North Embankment Composite (Duplicate)	22.7	6.9	7.7	3.8	0.03
1E and 2E Separator Composite	31.9	9.8	16.1	5.1	0.04
1E South Beach Composite	21.1	8.4	20.1	7	0.01
2W North Embankment Composite	46.9	8.1	8.5	4.6	0.06

Source: \\Van-svr0.van.na.srk.ad\ge\_projects\PolyMet Mining\1UP005.01\_Northmet\_project\_2004\Reports\2011-10\_Tailings\_Update\Re-Issue\LTVSMC\_Tailings\_Data\_1UP005.01\_Id\_rev00.xlsx

### 3.3 Humidity Cell Procedure

Shake flask testing of the samples prior to humidity cell testing indicated that the tailings were slightly oxidized due to weathering under field conditions. Since the purpose of humidity cells testing is to understand sulfide mineral oxidation rates, the samples were initially flushed with de-ionized water to remove soluble oxidation products. Following this procedure, the flushed samples were tested using the same procedures as used for NorthMet Project tailings.

### 3.4 Results

Selected humidity cell results from about 65 weeks of testing are shown in Figures 7 and 8.

Leachate pH values from all tests have been consistently between 7.3 and 8.1 and result mainly from leaching carbonate minerals. One of the 2E North Embankment samples showed consistently lower pH than the other tests. Likewise alkalinity, Ca and Mg were not comparable for the duplicate pair. All other parameters showed good reproducibility for the pair implying that the differences are due to heterogeneity in the carbonate content which did not affect elements associated with sulfide minerals.

Initial differences in sulfate release were observed. Higher release rates were observed for the two samples containing higher sulfur concentrations (2W North Embankment, and 1E and 2E Separator) but after about 25 weeks, differences disappeared and all samples yielded comparable low sulfate release. Leaching of trace elements occurred at very low rates. Arsenic, cobalt, manganese, molybdenum, selenium showed an initial decline like sulfate but most elements, including copper, nickel and zinc indicated no trend.

### 3.5 Conclusions

LTVSMC tailings leachate chemistry is dominated mainly by the buffering effects from dissolution of carbonate minerals. Initial differences in sulfate and some trace element release may be linked to differences in sulfide content but after about 25 weeks similar weathering behavior was shown regardless of sulfur content. Due to low sulfur content and expected long term effects of carbonate buffering, the tests have proceeded sufficiently to provide rates for input into water quality modeling. Release rates derived from these tests will be the average observed release over the 65-week testing period, which is conservative with respect to sulfate release.

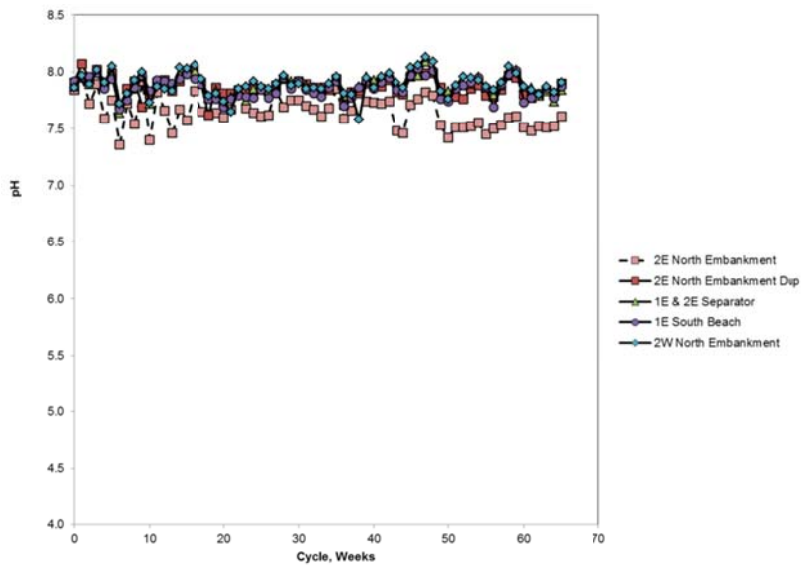

G:\PolyMet Mining\1UP005.01\_northmet\_project\_2004\Testwork\Tailings\3 Kinetic Tests\Results\Charts\Load\_LTV\_Borrow\_HCT\_Graphs\_1UP005001\_VER00.xlsx

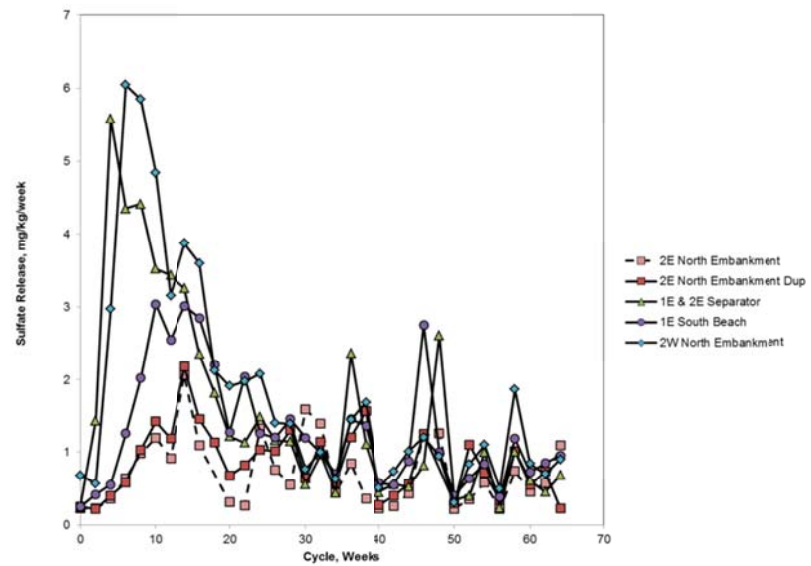

G:\PolyMet Mining\1UP005.01\_northmet\_project\_2004\Testwork\Tailings\3 Kinetic Tests\Results\Charts\Load\_LTV\_Borrow\_HCT\_Graphs\_1UP005001\_VER00.xlsx

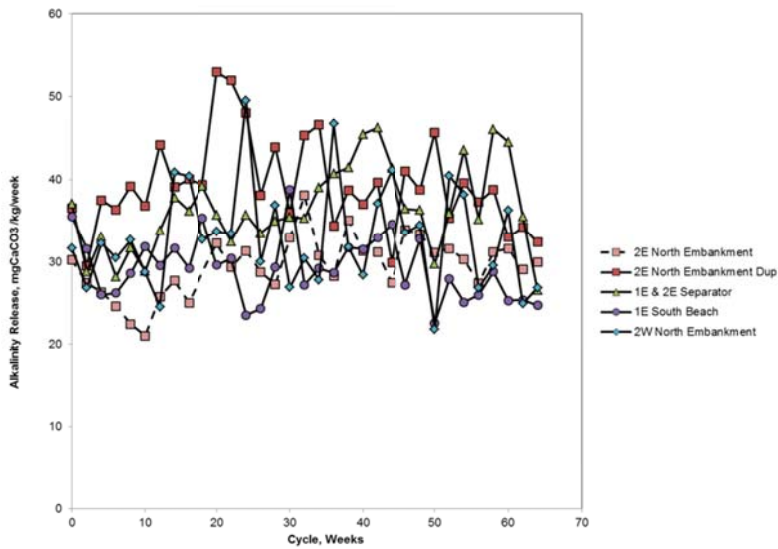

G:\PolyMet Mining\1UP005.01\_northmet\_project\_2004\Testwork\Tailings\3 Kinetic Tests\Results\Charts\Load\_LTV\_Borrow\_HCT\_Graphs\_1UP005001\_VER00.xlsx

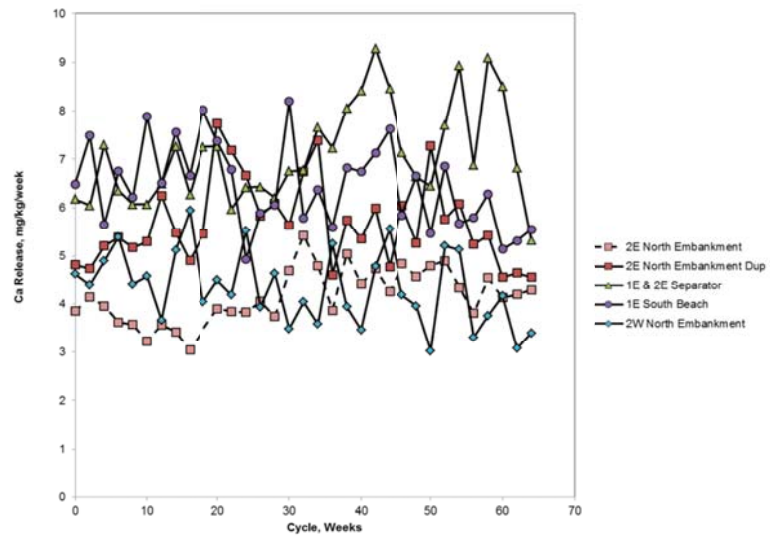

G:\PolyMet Mining\1UP005.01\_northmet\_project\_2004\Testwork\Tailings\3 Kinetic Tests\Results\Charts\Load\_LTV\_Borrow\_HCT\_Graphs\_1UP005001\_VER00.xlsx

Figure 7: Major Ion Results for LTVSMC Humidity Cells



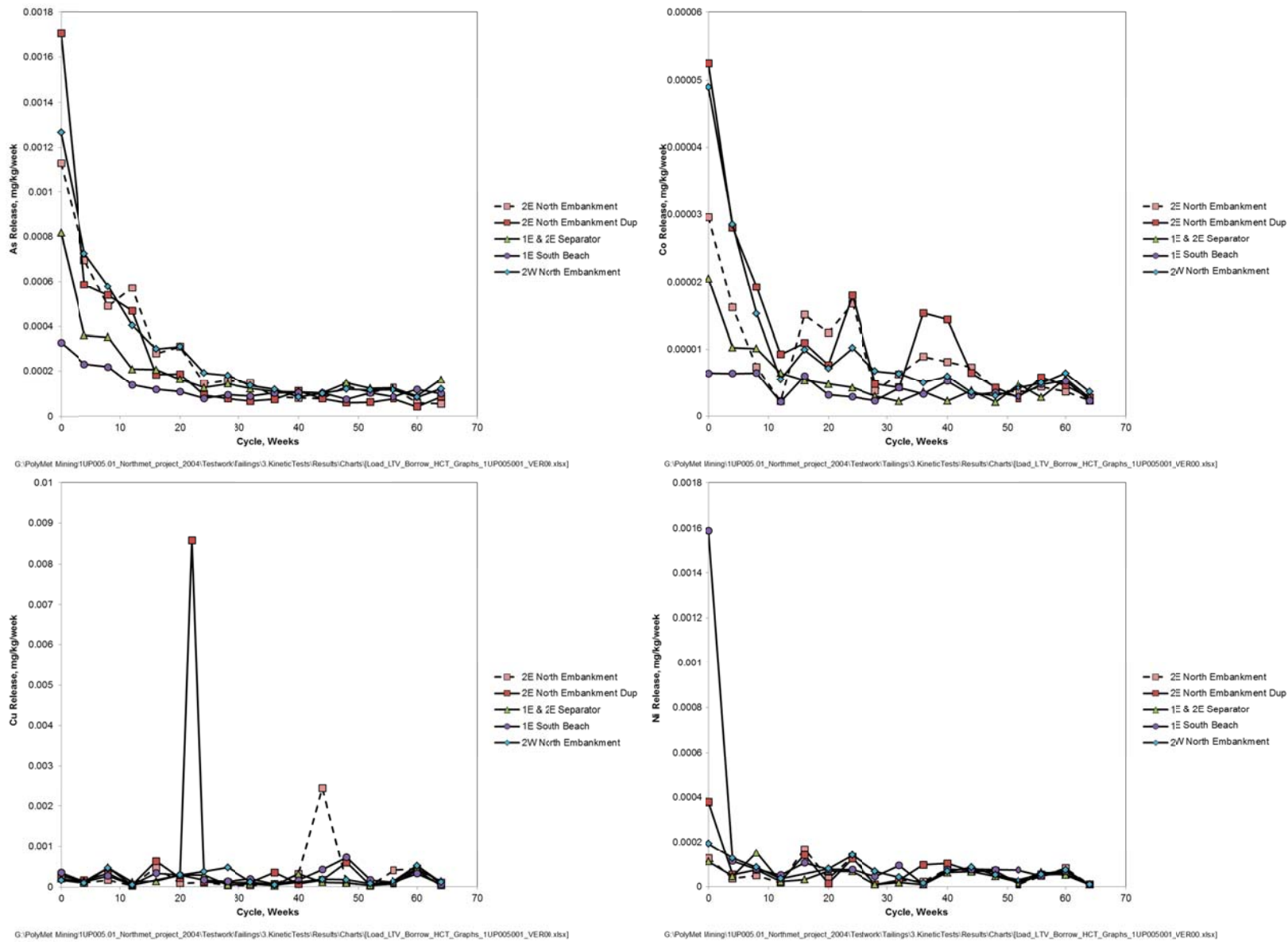

Figure 8: Trace Element Results for LTVSMC Humidity Cells

**SRK Consulting (Canada) Inc.**

Laura Donkervoort, M.Sc.  
Staff Consultant (Geochemistry)

Stephen Day, M.Sc., P.Geo.  
Corporate Consultant (Geochemistry)

**Attachment G**

**Laboratory Report for Barr Engineering Company (Tailings Samples)**

# Laboratory Report for Barr Engineering Company

Tailings Samples

October 22, 2010



*Daniel B. Stephens & Associates, Inc.*

5840 Osuna Road NE • Albuquerque, New Mexico 87109



October 22, 2010

Bethany S. Erfourth, PE  
Barr Engineering Company  
4700 W. 77th St.  
Edina, MN 55435  
(952) 832-2730

Re: DBS&A Laboratory Report for Barr Engineering Company Tailings Samples

Dear Mrs. Erfourth:

Enclosed is the final report for the Barr Engineering Company Tailings samples. Please review this report and provide any comments as samples will be held for a maximum of 30 days. After 30 days samples will be returned or disposed of in an appropriate manner.

All testing results were evaluated subjectively for consistency and reasonableness, and the results appear to be reasonably representative of the material tested. However, DBS&A does not assume any responsibility for interpretations or analyses based on the data enclosed, nor can we guarantee that these data are fully representative of the undisturbed materials at the field site. We recommend that careful evaluation of these laboratory results be made for your particular application.

The testing utilized to generate the enclosed final report employs methods that are standard for the industry. The results do not constitute a professional opinion by DBS&A, nor can the results affect any professional or expert opinions rendered with respect thereto by DBS&A. You have acknowledged that all the testing undertaken by us, and the final report provided, constitutes mere test results using standardized methods, and cannot be used to disqualify DBS&A from rendering any professional or expert opinion, having waived any claim of conflict of interest by DBS&A.

We are pleased to provide this service to Barr Engineering Company and look forward to future laboratory testing on other projects. If you have any questions about the enclosed data, please do not hesitate to call.

Sincerely,

DANIEL B. STEPHENS & ASSOCIATES, INC.  
SOIL TESTING & RESEARCH LABORATORY

Joleen Hines  
Laboratory Supervising Manager  
Enclosure

*Daniel B. Stephens & Associates, Inc.*  
*Soil Testing & Research Laboratory*

5840 Osuna Rd. NE  
Albuquerque, NM 87109

505-889-7752  
FAX 505-889-0258

## **Summaries**



Summary of Tests Performed

Laboratory Sample Number	Initial Soil Properties <sup>1</sup>			Saturated Hydraulic Conductivity <sup>2</sup>			Moisture Characteristics <sup>3</sup>							Particle Size <sup>4</sup>			Specific Gravity <sup>5</sup>		Air Perm-ability	Atterberg Limits	Proctor Compaction
	G	VM	VD	CH	FH	FW	HC	PP	FP	DPP	RH	EP	WHC	K <sub>unsat</sub>	DS	WS	H	F			
-200 fraction #1																	X				
-200 fraction #2																	X				
+200 fraction #1																	X				
+200 fraction #2																	X				
As Received															X	X	X				
Blend 1															X	X					
Blend 1 (38%)	X	X		X			X	X		X	X			X							
Blend 1 (45%)	X	X		X			X	X		X	X			X							
Blend 1 (55%)	X	X		X			X	X		X	X			X							
Blend 2															X	X					
Blend 2 (39%)	X	X		X			X	X		X	X			X							
Blend 2 (45%)	X	X		X			X	X		X	X			X							
Blend 2 (55%)	X	X		X			X	X		X	X			X							

<sup>1</sup> G = Gravimetric Moisture Content, VM = Volume Measurement Method, VD = Volume Displacement Method  
<sup>2</sup> CH = Constant Head Rigid Wall, FH = Falling Head Rigid Wall, FW = Falling Head Rising Tail Flexible Wall  
<sup>3</sup> HC = Hanging Column, PP = Pressure Plate, FP = Filter Paper, DPP = Dew Point Potentiometer, RH = Relative Humidity Box, EP = Effective Porosity, WHC = Water Holding Capacity, K<sub>unsat</sub> = Calculated Unsaturated Hydraulic Conductivity  
<sup>4</sup> DS = Dry Sieve, WS = Wet Sieve, H = Hydrometer  
<sup>5</sup> F = Fine (<4.75mm), C = Coarse (>4.75mm)



Summary of Tests Performed (Continued)

Laboratory Sample Number	Initial Soil Properties <sup>1</sup>			Saturated Hydraulic Conductivity <sup>2</sup>			Moisture Characteristics <sup>3</sup>							Particle Size <sup>4</sup>			Specific Gravity <sup>5</sup>		Air Perm- eability	Atterberg Limits	Proctor Compaction			
	G	VM	VD	CH	FH	FW	HC	PP	FP	DPP	RH	EP	WHC	K <sub>unsat</sub>	DS	WS	H	F				C		
Blend 3															X	X								
Blend 3 (40%)	X	X		X			X	X		X	X			X										
Blend 3 (45%)	X	X		X			X	X		X	X			X										
Blend 3 (55%)	X	X		X			X	X		X	X			X										
Blend 4															X	X								
Blend 4 (44%)	X	X		X			X	X		X	X			X										
Blend 4 (50%)	X	X		X			X	X		X	X			X										
Blend 4 (55%)	X	X		X			X	X		X	X			X										

<sup>1</sup> G = Gravimetric Moisture Content, VM = Volume Measurement Method, VD = Volume Displacement Method

<sup>2</sup> CH = Constant Head Rigid Wall, FH = Falling Head Rigid Wall, FW = Falling Head Rising Tail Flexible Wall

<sup>3</sup> HC = Hanging Column, PP = Pressure Plate, FP = Filter Paper, DPP = Dew Point Potentiometer, RH = Relative Humidity Box, EP = Effective Porosity, WHC = Water Holding Capacity, K<sub>unsat</sub> = Calculated Unsaturated Hydraulic Conductivity

<sup>4</sup> DS = Dry Sieve, WS = Wet Sieve, H = Hydrometer

<sup>5</sup> F = Fine (<4.75mm), C = Coarse (>4.75mm)





## Notes

One sample was received in four buckets. The four 1/2-3/4 full buckets were composited into one sample. The composited material was split on a #200 (0.075 mm) sieve by soaking the material in hot water overnight, followed by washing the material over the #200 sieve, again using hot water. All +200 (>0.075 mm) material and -200 (<0.075 mm) material was retained and dried.

Four separate blend samples were created using the dry +200 and -200 fractions by targeting the client provided percentages provided in the table below. All percentages are mass based.

Particle size analyses were performed on each blend to verify the actual percent passing the #200 sieve used to create each blend. The actual percent passing the #200 sieve used to create each blend was higher than the target value. This was due to material passing the #200 sieve remaining in the material retained on the #200 sieve; i.e. the initial washing and splitting process did not completely remove all material passing the #200 sieve from the material retained on the #200 sieve.

	% Passing #200	
	Target	Actual
Blend 1	75%	77%
Blend 2	50%	56%
Blend 3	30%	37%
Blend 4	10%	21%

The specific gravity (particle density) of the +200 and -200 fractions was measured in duplicate. The average of each the duplicate measurements was applied to each of the fractions. The particle density of each blend was then calculated based on the weighted average of the two fractions used for each blend.

The total porosity target remold values for each blend were initially 30%, 40%, and 50%. After determining that 30% total porosity was not achievable for Blend 4, the target total porosity values were revised to 'as tight as possible', 45% porosity, and 55% porosity for samples Blend 1, Blend 2, and Blend 3; and target remold values for Blend 4 were revised to 'as tight as possible', 50% porosity, and 55% porosity. The remolded samples were subjected to saturated hydraulic conductivity and moisture retention testing.



**Summary of Sample Preparation/Volume Changes-Density Based**

Sample Number	Target Remold Parameters <sup>1</sup>		Actual Remold Data			Volume Change Post Saturation <sup>2</sup>			Volume Change Post Drying Curve <sup>3</sup>		
	Moisture Content (%, g/g)	Dry Bulk Density (g/cm <sup>3</sup> )	Moisture Content (%, g/g)	Dry Bulk Density (g/cm <sup>3</sup> )	% of Target Density (%)	Dry Bulk Density (g/cm <sup>3</sup> )	% Volume Change (%)	% of Target Density (%)	Dry Bulk Density (g/cm <sup>3</sup> )	% Volume Change (%)	% of Target Density (%)
Blend 1 (38%)	8	1.85	8.3	1.85	100.0%	1.85	---	100%	1.85	---	100%
Blend 1 (45%)	8	1.64	8.3	1.64	99.6%	1.64	---	100%	1.70	(-) 3.6%	103%
Blend 1 (55%)	8	1.35	9.8	1.32	98.4%	1.60	(-) 17.0%	119%	1.86	(-) 29.0%	139%
Blend 2 (39%)	8	1.80	8.9	1.80	100.0%	1.80	---	100%	1.80	---	100%
Blend 2 (45%)	8	1.64	8.2	1.63	99.6%	1.69	(-) 3.4%	103%	1.79	(-) 8.9%	109%
Blend 2 (55%)	8	1.34	9.9	1.32	98.4%	1.67	(-) 20.8%	124%	1.92	(-) 31.1%	143%
Blend 3 (40%)	8	1.80	8.4	1.80	100.0%	1.80	---	100%	1.80	---	100%
Blend 3 (45%)	8	1.64	8.3	1.63	99.7%	1.69	(-) 3.1%	103%	1.77	(-) 7.8%	108%
Blend 3 (55%)	8	1.34	10.5	1.31	97.9%	1.73	(-) 24.3%	129%	1.89	(-) 30.5%	141%
Blend 4 (44%)	8	1.64	8.8	1.64	100.4%	1.64	---	100%	1.64	---	100%
Blend 4 (50%)	8	1.49	8.4	1.48	99.6%	1.55	(-) 4.4%	104%	1.58	(-) 6.1%	106%
Blend 4 (55%)	8	1.34	8.1	1.34	99.9%	1.54	(-) 13.0%	115%	1.60	(-) 16.2%	119%

<sup>1</sup>Target Remold Parameters: Provided by the client. See Notes page.

<sup>2</sup>Volume Change Post Saturation: Volume change measurements were obtained after saturated hydraulic conductivity testing.

<sup>3</sup>Volume Change Post Drying Curve: Volume change measurements were obtained throughout hanging column and pressure plate testing. The 'Volume Change Post Drying Curve' values represent the final sample dimensions after the last pressure plate point.

Notes:

(+) indicates sample swelling, (-) indicates sample settling, and "----" indicates no volume change occurred.



### Summary of Sample Preparation/Volume Changes-Porosity Based

Sample Number	Target Remold Parameters <sup>1</sup>		Actual Remold Data			Volume Change Post Saturation <sup>2</sup>			Volume Change Post Drying Curve <sup>3</sup>		
	Moisture Content	Calc. Porosity	Moisture Content	Calc. Porosity	% of Target Porosity	Calc. Porosity	% Volume Change	% of Target Porosity	Calc. Porosity	% Volume Change	% of Target Porosity
	(%, g/g)	(%)	(%, g/g)	(%)	(%)	(%)	(%)	(%)	(%)	(%)	(%)
Blend 1 (38%)	8	38.1	8.3	38.1	100.0%	38.1	---	100.0%	38.1	---	100.0%
Blend 1 (45%)	8	45.0	8.3	45.3	100.6%	45.3	---	100.6%	43.2	(-) 3.6%	96.0%
Blend 1 (55%)	8	55.0	9.8	55.7	101.3%	46.6	(-) 17.0%	84.7%	37.6	(-) 29.0%	68.4%
Blend 2 (39%)	8	39.6	8.9	39.6	100.0%	39.6	---	100.0%	39.6	---	100.0%
Blend 2 (45%)	8	45.0	8.2	45.2	100.5%	43.3	(-) 3.4%	96.3%	39.9	(-) 8.9%	88.6%
Blend 2 (55%)	8	55.0	9.9	55.8	101.4%	44.2	(-) 20.8%	80.3%	35.8	(-) 31.1%	65.1%
Blend 3 (40%)	8	39.7	8.4	39.7	100.0%	39.7	---	100.0%	39.7	---	100.0%
Blend 3 (45%)	8	45.0	8.3	45.2	100.4%	43.4	(-) 3.1%	96.5%	40.6	(-) 7.8%	90.2%
Blend 3 (55%)	8	55.0	10.5	56.0	101.8%	41.9	(-) 24.3%	76.1%	36.7	(-) 30.5%	66.7%
Blend 4 (44%)	8	44.8	8.8	44.8	100.0%	44.8	---	100.0%	44.8	---	100.0%
Blend 4 (50%)	8	50.0	8.4	50.3	100.5%	47.9	(-) 4.4%	95.9%	47.0	(-) 6.1%	94.0%
Blend 4 (55%)	8	55.0	8.1	55.1	100.1%	48.4	(-) 13.0%	88.0%	46.4	(-) 16.2%	84.3%

<sup>1</sup>Target Remold Parameters: Provided by the client. See Notes page.

<sup>2</sup>Volume Change Post Saturation: Volume change measurements were obtained after saturated hydraulic conductivity testing.

<sup>3</sup>Volume Change Post Drying Curve: Volume change measurements were obtained throughout hanging column and pressure plate testing. The 'Volume Change Post Drying Curve' values represent the final sample dimensions after the last pressure plate point.

Notes:

(+) indicates sample swelling, (-) indicates sample settling, and "---" indicates no volume change occurred.



**Summary of Initial Moisture Content, Dry Bulk Density  
Wet Bulk Density and Calculated Porosity**

Sample Number	Moisture Content				Dry Bulk Density (g/cm <sup>3</sup> )	Wet Bulk Density (g/cm <sup>3</sup> )	Calculated Porosity (%)
	As Received		Remolded				
	Gravimetric (%, g/g)	Volumetric (%, cm <sup>3</sup> /cm <sup>3</sup> )	Gravimetric (%, g/g)	Volumetric (%, cm <sup>3</sup> /cm <sup>3</sup> )			
Blend 1 (38%)	NA	NA	8.3	15.3	1.85	2.00	38.1
Blend 1 (45%)	NA	NA	8.3	13.6	1.64	1.77	45.3
Blend 1 (55%)	NA	NA	9.8	13.0	1.32	1.45	55.7
Blend 2 (39%)	NA	NA	8.9	16.1	1.80	1.96	39.6
Blend 2 (45%)	NA	NA	8.2	13.4	1.63	1.77	45.2
Blend 2 (55%)	NA	NA	9.9	13.0	1.32	1.45	55.8
Blend 3 (40%)	NA	NA	8.4	15.1	1.80	1.95	39.7
Blend 3 (45%)	NA	NA	8.3	13.5	1.63	1.77	45.2
Blend 3 (55%)	NA	NA	10.5	13.8	1.31	1.45	56.0
Blend 4 (44%)	NA	NA	8.8	14.4	1.64	1.79	44.8
Blend 4 (50%)	NA	NA	8.4	12.5	1.48	1.60	50.3
Blend 4 (55%)	NA	NA	8.1	10.8	1.34	1.45	55.1

NA = Not analyzed

--- = This sample was not remolded



### Summary of Saturated Hydraulic Conductivity Tests

Sample Number	K <sub>sat</sub> (cm/sec)	Oversize Corrected K <sub>sat</sub> (cm/sec)	Method of Analysis	
			Constant Head	Falling Head
Blend 1 (38%)	7.4E-05	NA	X	
Blend 1 (45%)	1.4E-04	NA	X	
Blend 1 (55%)	4.9E-04	NA	X	
Blend 2 (39%)	2.4E-04	NA	X	
Blend 2 (45%)	5.2E-04	NA	X	
Blend 2 (55%)	1.4E-03	NA	X	
Blend 3 (40%)	6.9E-04	NA	X	
Blend 3 (45%)	2.0E-03	NA	X	
Blend 3 (55%)	1.6E-03	NA	X	
Blend 4 (44%)	3.7E-03	NA	X	
Blend 4 (50%)	3.9E-03	NA	X	
Blend 4 (55%)	9.8E-03	NA	X	

--- = Oversize correction is unnecessary since coarse fraction < 5% of composite mass  
 NR = Not requested  
 NA = Not applicable



### Summary of Moisture Characteristics of the Initial Drainage Curve

Sample Number	Pressure Head (-cm water)	Moisture Content (%, cm <sup>3</sup> /cm <sup>3</sup> )
Blend 1 (38%)	0	40.3
	17	39.9
	49	39.7
	123	39.7
	337	25.9
	14685	3.8
	38752	2.2
	124416	1.7
	861325	0.7
Blend 1 (45%)	0	45.0
	12	43.8
	31	42.8
	101	42.4 #
	337	25.9 #
	17439	3.9 #
	41200	2.5 #
	132268	1.3 #
	861325	0.7 #
Blend 1 (55%)	0	48.0 #
	12	40.8 #
	31	38.6 #
	101	37.4 #
	337	33.7 #
	17745	4.2 #
	44769	2.6 #
	109323	1.9 #
	861325	0.7 #

# Volume adjustments are applicable at this matric potential (see data sheet for this sample).



**Summary of Moisture Characteristics  
of the Initial Drainage Curve (Continued)**

Sample Number	Pressure Head (-cm water)	Moisture Content (%, cm <sup>3</sup> /cm <sup>3</sup> )
Blend 2 (39%)	0	39.9
	12	38.6
	31	38.2
	101	37.9
	337	16.9
	16419	2.5
	35489	1.8
	142772	1.3
	861325	0.6
Blend 2 (45%)	0	45.8 #
	12	43.5 #
	31	41.7 #
	101	40.2 #
	337	19.4 #
	14583	2.6 #
	35489	1.5 #
	126455	1.0 #
	861325	0.6 #
Blend 2 (55%)	0	46.6 #
	5	41.1 #
	21	39.4 #
	76	37.3 #
	337	21.6 #
	17541	2.9 #
	44565	1.7 #
	106875	1.4 #
	861325	0.7 #

# Volume adjustments are applicable at this matric potential (see data sheet for this sample).



**Summary of Moisture Characteristics  
of the Initial Drainage Curve (Continued)**

Sample Number	Pressure Head (-cm water)	Moisture Content (%, cm <sup>3</sup> /cm <sup>3</sup> )
Blend 3 (40%)	0	39.7
	12	39.1
	31	38.8
	101	27.0
	337	12.3
	16215	3.2
	36611	2.9
	138387	2.0
	861325	0.6
Blend 3 (45%)	0	44.9 #
	5	42.9 #
	21	41.5 #
	76	39.7 #
	337	12.1 #
	14481	2.0 #
	41098	1.3 #
	141752	0.9 #
	861325	0.6 #
Blend 3 (55%)	0	44.0 #
	5	38.7 #
	21	37.1 #
	76	36.7 #
	337	12.1 #
	12951	1.9 #
	34673	1.3 #
	123396	1.0 #
	861325	0.6 #

# Volume adjustments are applicable at this matric potential (see data sheet for this sample).





**Summary of Moisture Characteristics  
of the Initial Drainage Curve (Continued)**

Sample Number	Pressure Head (-cm water)	Moisture Content (%, cm <sup>3</sup> /cm <sup>3</sup> )
Blend 4 (44%)	0	43.1
	5	42.8
	21	42.5
	76	32.7
	337	5.3
	19274	1.2
	57619	0.9
	151440	0.7
	861325	0.5
Blend 4 (50%)	0	42.2 #
	6	42.1 #
	30	41.4 #
	71	26.3 #
	337	4.5 #
	16929	1.4 #
	46197	1.0 #
	265658	0.8 #
	861325	0.4 #
Blend 4 (55%)	0	41.6 #
	6	40.7 #
	30	39.8 #
	71	29.3 #
	337	4.7 #
	6323	2.0 #
	66695	0.6 #
	105345	0.7 #
	861325	0.5 #

# Volume adjustments are applicable at this matric potential (see data sheet for this sample).



### Summary of Calculated Unsaturated Hydraulic Properties

Sample Number	$\alpha$ ( $\text{cm}^{-1}$ )	N (dimensionless)	$\theta_r$ (% vol)	$\theta_s$ (% vol)	Oversize Corrected	
					$\theta_r$ (% vol)	$\theta_s$ (% vol)
Blend 1 (38%)	0.0028	4.4060	2.10	39.97	NA	NA
Blend 1 (45%)	0.0037	2.3302	2.04	44.09	NA	NA
Blend 1 (55%)	0.0032	1.5352	0.00	42.21	NA	NA
Blend 2 (39%)	0.0039	3.4263	1.55	38.91	NA	NA
Blend 2 (45%)	0.0049	2.3810	1.36	43.86	NA	NA
Blend 2 (55%)	0.0097	1.5315	0.20	43.07	NA	NA
Blend 3 (40%)	0.0112	1.9686	2.08	39.94	NA	NA
Blend 3 (45%)	0.0065	2.6280	1.17	43.17	NA	NA
Blend 3 (55%)	0.0066	2.4829	1.18	40.08	NA	NA
Blend 4 (44%)	0.0106	2.7451	0.81	42.95	NA	NA
Blend 4 (50%)	0.0148	2.7336	1.07	42.67	NA	NA
Blend 4 (55%)	0.0127	2.6317	0.95	41.31	NA	NA

--- = Oversize correction is unnecessary since coarse fraction < 5% of composite mass  
 NR = Not requested  
 NA = Not applicable



### Summary of Particle Size Characteristics

Sample Number	d <sub>10</sub> (mm)	d <sub>50</sub> (mm)	d <sub>60</sub> (mm)	C <sub>u</sub>	C <sub>c</sub>	Method	ASTM Classification	USDA Classification
As Received	0.010	0.076	0.096	9.6	2.1	WS/H	Silty sand (SM)	Sandy Loam
Blend 1	0.0037	0.037	0.048	13	1.6	WS/H	Silt with sand (ML)s	Silt Loam
Blend 2	0.0056	0.062	0.082	15	2.2	WS/H	Sandy silt s(ML)	Sandy Loam
Blend 3	0.013	0.092	0.11	8.5	2.4	WS/H	Silty sand (SM)	Loamy Sand
Blend 4	0.051	0.11	0.14	2.7	1.0	WS/H	Silty sand (SM)	Sand

d<sub>50</sub> = Median particle diameter

Est = Reported values for d<sub>10</sub>, C<sub>u</sub>, C<sub>c</sub>, and soil classification are estimates, since extrapolation was required to obtain the d<sub>10</sub> diameter

$$C_u = \frac{d_{60}}{d_{10}}$$

$$C_c = \frac{(d_{30})^2}{(d_{10})(d_{60})}$$

DS = Dry sieve

H = Hydrometer

WS = Wet sieve

† Greater than 10% of sample is coarse material



**Percent Gravel, Sand, Silt and Clay\***

Sample Number	% Gravel (>4.75mm)	% Sand (<4.75mm, >0.075mm)	% Silt (<0.075mm, >0.002mm)	% Clay (<0.002mm)
As Received	0.0	50.3	43.8	5.9
Blend 1	0.0	22.9	70.0	7.1
Blend 2	0.0	43.5	51.1	5.4
Blend 3	0.0	62.6	34.0	3.4
Blend 4	0.0	78.6	19.3	2.1

\*USCS classification does not classify clay fraction based on particle size. USDA definition of clay (<0.002mm) used in this table.



### Summary of Specific Gravity Tests

Sample Number	<4.75mm Material		>4.75mm Material		Bulk Sample
	Specific Gravity	Percent of Bulk Sample	Specific Gravity	Percent of Bulk Sample	Specific Gravity
-200 fraction #1	3.01	100.0	---	0.0	3.01
-200 fraction #2	2.99	100.0	---	0.0	2.99
-200 Average	3.00	100.0	---	0.0	3.00
+200 fraction #1	2.97	100.0	---	0.0	2.97
+200 fraction #2	2.98	100.0	---	0.0	2.98
+200 Average	2.98	100.0	---	0.0	2.98
As Received	2.95	100.0	---	0.0	2.95

--- = Unnecessary since specified fraction <5% of composite mass

\* = Based on specific gravity of material < 4.75 mm

# **Laboratory Data and Graphical Plots**

## **Initial Properties**



**Summary of Initial Moisture Content, Dry Bulk Density  
Wet Bulk Density and Calculated Porosity**

Sample Number	Moisture Content				Dry Bulk Density (g/cm <sup>3</sup> )	Wet Bulk Density (g/cm <sup>3</sup> )	Calculated Porosity (%)
	As Received		Remolded				
	Gravimetric (%, g/g)	Volumetric (%, cm <sup>3</sup> /cm <sup>3</sup> )	Gravimetric (%, g/g)	Volumetric (%, cm <sup>3</sup> /cm <sup>3</sup> )			
Blend 1 (38%)	NA	NA	8.3	15.3	1.85	2.00	38.1
Blend 1 (45%)	NA	NA	8.3	13.6	1.64	1.77	45.3
Blend 1 (55%)	NA	NA	9.8	13.0	1.32	1.45	55.7
Blend 2 (39%)	NA	NA	8.9	16.1	1.80	1.96	39.6
Blend 2 (45%)	NA	NA	8.2	13.4	1.63	1.77	45.2
Blend 2 (55%)	NA	NA	9.9	13.0	1.32	1.45	55.8
Blend 3 (40%)	NA	NA	8.4	15.1	1.80	1.95	39.7
Blend 3 (45%)	NA	NA	8.3	13.5	1.63	1.77	45.2
Blend 3 (55%)	NA	NA	10.5	13.8	1.31	1.45	56.0
Blend 4 (44%)	NA	NA	8.8	14.4	1.64	1.79	44.8
Blend 4 (50%)	NA	NA	8.4	12.5	1.48	1.60	50.3
Blend 4 (55%)	NA	NA	8.1	10.8	1.34	1.45	55.1

NA = Not analyzed

--- = This sample was not remolded





### Data for Initial Moisture Content, Bulk Density, Porosity, and Percent Saturation

Job Name: Barr Engineering Company  
Job Number: LB10.0170.00  
Sample Number: Blend 1 (38%)  
Ring Number: NA  
Depth: NA

	<u>As Received</u>	<u>Remolded</u>
Test Date:	NA	24-Aug-10
Field weight* of sample (g):		375.07
Tare weight, ring (g):		88.69
Tare weight, pan/plate (g):		0.00
Tare weight, other (g):		0.00
Dry weight of sample (g):		264.49
Sample volume (cm <sup>3</sup> ):		142.91
Measured particle density (g/cm <sup>3</sup> ):		2.99
<hr/>		
Gravimetric Moisture Content (% g/g):		8.3
Volumetric Moisture Content (% vol):		15.3
Dry bulk density (g/cm <sup>3</sup> ):		1.85
Wet bulk density (g/cm <sup>3</sup> ):		2.00
Calculated Porosity (% vol):		38.1
Percent Saturation:		40.2
<hr/>		
Laboratory analysis by:		K. Wright
Data entered by:		C. Krous
Checked by:		J. Hines

Comments:

- \* Weight including tares
- NA = Not analyzed
- = This sample was not remolded



### Data for Initial Moisture Content, Bulk Density, Porosity, and Percent Saturation

Job Name: Barr Engineering Company  
Job Number: LB10.0170.00  
Sample Number: Blend 1 (45%)  
Ring Number: NA  
Depth: NA

	<u>As Received</u>	<u>Remolded</u>
Test Date:	NA	25-Aug-10
Field weight* of sample (g):		341.79
Tare weight, ring (g):		87.09
Tare weight, pan/plate (g):		0.00
Tare weight, other (g):		0.00
Dry weight of sample (g):		235.17
Sample volume (cm <sup>3</sup> ):		143.74
Measured particle density (g/cm <sup>3</sup> ):		2.99
<hr/>		
Gravimetric Moisture Content (% g/g):		8.3
Volumetric Moisture Content (% vol):		13.6
Dry bulk density (g/cm <sup>3</sup> ):		1.64
Wet bulk density (g/cm <sup>3</sup> ):		1.77
Calculated Porosity (% vol):		45.3
Percent Saturation:		30.0
<hr/>		
Laboratory analysis by:		K. Wright
Data entered by:		C. Krous
Checked by:		J. Hines

Comments:

- \* Weight including tares
- NA = Not analyzed
- = This sample was not remolded



**Data for Initial Moisture Content,  
Bulk Density, Porosity, and Percent Saturation**

Job Name: Barr Engineering Company  
 Job Number: LB10.0170.00  
 Sample Number: Blend 1 (55%)  
 Ring Number: NA  
 Depth: NA

	<u>As Received</u>	<u>Remolded</u>
Test Date:	NA	25-Aug-10
Field weight* of sample (g):		289.35
Tare weight, ring (g):		85.21
Tare weight, pan/plate (g):		0.00
Tare weight, other (g):		0.00
Dry weight of sample (g):		185.91
Sample volume (cm <sup>3</sup> ):		140.40
Measured particle density (g/cm <sup>3</sup> ):		2.99
<hr/>		
Gravimetric Moisture Content (% g/g):		9.8
Volumetric Moisture Content (% vol):		13.0
Dry bulk density (g/cm <sup>3</sup> ):		1.32
Wet bulk density (g/cm <sup>3</sup> ):		1.45
Calculated Porosity (% vol):		55.7
Percent Saturation:		23.3
<hr/>		
Laboratory analysis by:		K. Wright
Data entered by:		C. Krous
Checked by:		J. Hines

Comments:

- \* Weight including tares
- NA = Not analyzed
- = This sample was not remolded



**Data for Initial Moisture Content,  
Bulk Density, Porosity, and Percent Saturation**

Job Name: Barr Engineering Company  
 Job Number: LB10.0170.00  
 Sample Number: Blend 2 (39%)  
 Ring Number: NA  
 Depth: NA

	<u>As Received</u>	<u>Remolded</u>
Test Date:	NA	25-Aug-10
Field weight* of sample (g):		377.41
Tare weight, ring (g):		89.02
Tare weight, pan/plate (g):		0.00
Tare weight, other (g):		0.00
Dry weight of sample (g):		264.75
Sample volume (cm <sup>3</sup> ):		147.03
Measured particle density (g/cm <sup>3</sup> ):		2.98
<hr/>		
Gravimetric Moisture Content (% g/g):		8.9
Volumetric Moisture Content (% vol):		16.1
Dry bulk density (g/cm <sup>3</sup> ):		1.80
Wet bulk density (g/cm <sup>3</sup> ):		1.96
Calculated Porosity (% vol):		39.6
Percent Saturation:		40.6
<hr/>		
Laboratory analysis by:		K. Wright
Data entered by:		C. Krous
Checked by:		J. Hines

Comments:

- \* Weight including tares
- NA = Not analyzed
- = This sample was not remolded



**Data for Initial Moisture Content,  
Bulk Density, Porosity, and Percent Saturation**

Job Name: Barr Engineering Company  
 Job Number: LB10.0170.00  
 Sample Number: Blend 2 (45%)  
 Ring Number: NA  
 Depth: NA

	<u>As Received</u>	<u>Remolded</u>
Test Date:	NA	25-Aug-10
Field weight* of sample (g):		357.60
Tare weight, ring (g):		110.15
Tare weight, pan/plate (g):		0.00
Tare weight, other (g):		0.00
Dry weight of sample (g):		228.69
Sample volume (cm <sup>3</sup> ):		139.97
Measured particle density (g/cm <sup>3</sup> ):		2.98
<hr/>		
Gravimetric Moisture Content (% g/g):		8.2
Volumetric Moisture Content (% vol):		13.4
Dry bulk density (g/cm <sup>3</sup> ):		1.63
Wet bulk density (g/cm <sup>3</sup> ):		1.77
Calculated Porosity (% vol):		45.2
Percent Saturation:		29.6
<hr/>		
Laboratory analysis by:		K. Wright
Data entered by:		C. Krous
Checked by:		J. Hines

Comments:

- \* Weight including tares
- NA = Not analyzed
- = This sample was not remolded



**Data for Initial Moisture Content,  
Bulk Density, Porosity, and Percent Saturation**

Job Name: Barr Engineering Company  
 Job Number: LB10.0170.00  
 Sample Number: Blend 2 (55%)  
 Ring Number: NA  
 Depth: NA

	<u>As Received</u>	<u>Remolded</u>
Test Date:	NA	25-Aug-10
Field weight* of sample (g):		320.64
Tare weight, ring (g):		116.30
Tare weight, pan/plate (g):		0.00
Tare weight, other (g):		0.00
Dry weight of sample (g):		185.98
Sample volume (cm <sup>3</sup> ):		140.88
Measured particle density (g/cm <sup>3</sup> ):		2.98
<hr/>		
Gravimetric Moisture Content (% g/g):		9.9
Volumetric Moisture Content (% vol):		13.0
Dry bulk density (g/cm <sup>3</sup> ):		1.32
Wet bulk density (g/cm <sup>3</sup> ):		1.45
Calculated Porosity (% vol):		55.8
Percent Saturation:		23.4
<hr/>		
Laboratory analysis by:		K. Wright
Data entered by:		C. Krous
Checked by:		J. Hines

Comments:

- \* Weight including tares
- NA = Not analyzed
- = This sample was not remolded



**Data for Initial Moisture Content,  
Bulk Density, Porosity, and Percent Saturation**

Job Name: Barr Engineering Company  
 Job Number: LB10.0170.00  
 Sample Number: Blend 3 (40%)  
 Ring Number: NA  
 Depth: NA

	<u>As Received</u>	<u>Remolded</u>
Test Date:	NA	25-Aug-10
Field weight* of sample (g):		366.15
Tare weight, ring (g):		87.14
Tare weight, pan/plate (g):		0.00
Tare weight, other (g):		0.00
Dry weight of sample (g):		257.44
Sample volume (cm <sup>3</sup> ):		143.29
Measured particle density (g/cm <sup>3</sup> ):		2.98
<hr/>		
Gravimetric Moisture Content (% g/g):		8.4
Volumetric Moisture Content (% vol):		15.1
Dry bulk density (g/cm <sup>3</sup> ):		1.80
Wet bulk density (g/cm <sup>3</sup> ):		1.95
Calculated Porosity (% vol):		39.7
Percent Saturation:		37.9
<hr/>		
Laboratory analysis by:		K. Wright
Data entered by:		C. Krous
Checked by:		J. Hines

Comments:

- \* Weight including tares
- NA = Not analyzed
- = This sample was not remolded



**Data for Initial Moisture Content,  
Bulk Density, Porosity, and Percent Saturation**

Job Name: Barr Engineering Company  
 Job Number: LB10.0170.00  
 Sample Number: Blend 3 (45%)  
 Ring Number: NA  
 Depth: NA

	<u>As Received</u>	<u>Remolded</u>
Test Date:	NA	25-Aug-10
Field weight* of sample (g):		339.40
Tare weight, ring (g):		87.13
Tare weight, pan/plate (g):		0.00
Tare weight, other (g):		0.00
Dry weight of sample (g):		232.98
Sample volume (cm <sup>3</sup> ):		142.72
Measured particle density (g/cm <sup>3</sup> ):		2.98
<hr/>		
Gravimetric Moisture Content (% g/g):		8.3
Volumetric Moisture Content (% vol):		13.5
Dry bulk density (g/cm <sup>3</sup> ):		1.63
Wet bulk density (g/cm <sup>3</sup> ):		1.77
Calculated Porosity (% vol):		45.2
Percent Saturation:		29.9
<hr/>		
Laboratory analysis by:		K. Wright
Data entered by:		C. Krous
Checked by:		J. Hines

Comments:

- \* Weight including tares
- NA = Not analyzed
- = This sample was not remolded





**Data for Initial Moisture Content,  
Bulk Density, Porosity, and Percent Saturation**

Job Name: Barr Engineering Company  
 Job Number: LB10.0170.00  
 Sample Number: Blend 3 (55%)  
 Ring Number: NA  
 Depth: NA

	<u>As Received</u>	<u>Remolded</u>
Test Date:	NA	25-Aug-10
Field weight* of sample (g):		300.46
Tare weight, ring (g):		88.41
Tare weight, pan/plate (g):		0.00
Tare weight, other (g):		0.00
Dry weight of sample (g):		191.84
Sample volume (cm <sup>3</sup> ):		146.31
Measured particle density (g/cm <sup>3</sup> ):		2.98
<hr/>		
Gravimetric Moisture Content (% g/g):		10.5
Volumetric Moisture Content (% vol):		13.8
Dry bulk density (g/cm <sup>3</sup> ):		1.31
Wet bulk density (g/cm <sup>3</sup> ):		1.45
Calculated Porosity (% vol):		56.0
Percent Saturation:		24.7
<hr/>		
Laboratory analysis by:		K. Wright
Data entered by:		C. Krous
Checked by:		J. Hines

Comments:

- \* Weight including tares
- NA = Not analyzed
- = This sample was not remolded



**Data for Initial Moisture Content,  
Bulk Density, Porosity, and Percent Saturation**

Job Name: Barr Engineering Company  
 Job Number: LB10.0170.00  
 Sample Number: Blend 4 (44%)  
 Ring Number: NA  
 Depth: NA

	<u>As Received</u>	<u>Remolded</u>
Test Date:	NA	24-Aug-10
Field weight* of sample (g):		345.02
Tare weight, ring (g):		87.15
Tare weight, pan/plate (g):		0.00
Tare weight, other (g):		0.00
Dry weight of sample (g):		237.11
Sample volume (cm <sup>3</sup> ):		144.43
Measured particle density (g/cm <sup>3</sup> ):		2.98
<hr/>		
Gravimetric Moisture Content (% g/g):		8.8
Volumetric Moisture Content (% vol):		14.4
Dry bulk density (g/cm <sup>3</sup> ):		1.64
Wet bulk density (g/cm <sup>3</sup> ):		1.79
Calculated Porosity (% vol):		44.8
Percent Saturation:		32.1
<hr/>		
Laboratory analysis by:		K. Wright
Data entered by:		C. Krous
Checked by:		J. Hines

Comments:

- \* Weight including tares
- NA = Not analyzed
- = This sample was not remolded



**Data for Initial Moisture Content,  
Bulk Density, Porosity, and Percent Saturation**

Job Name: Barr Engineering Company  
 Job Number: LB10.0170.00  
 Sample Number: Blend 4 (50%)  
 Ring Number: NA  
 Depth: NA

	<u>As Received</u>	<u>Remolded</u>
Test Date:	NA	10-Sep-10
Field weight* of sample (g):		319.29
Tare weight, ring (g):		88.63
Tare weight, pan/plate (g):		0.00
Tare weight, other (g):		0.00
Dry weight of sample (g):		212.69
Sample volume (cm <sup>3</sup> ):		143.72
Measured particle density (g/cm <sup>3</sup> ):		2.98
<hr/>		
Gravimetric Moisture Content (% g/g):		8.4
Volumetric Moisture Content (% vol):		12.5
Dry bulk density (g/cm <sup>3</sup> ):		1.48
Wet bulk density (g/cm <sup>3</sup> ):		1.60
Calculated Porosity (% vol):		50.3
Percent Saturation:		24.9
<hr/>		
Laboratory analysis by:		K. Wright
Data entered by:		C. Krous
Checked by:		J. Hines

Comments:

- \* Weight including tares
- NA = Not analyzed
- = This sample was not remolded



Data for Initial Moisture Content, Bulk Density, Porosity, and Percent Saturation

Job Name: Barr Engineering Company
Job Number: LB10.0170.00
Sample Number: Blend 4 (55%)
Ring Number: NA
Depth: NA

Table with 3 columns: Test Date, As Received, Remolded. Rows include Field weight\* of sample (g), Tare weight, ring (g), Tare weight, pan/plate (g), Tare weight, other (g), Dry weight of sample (g), Sample volume (cm^3), and Measured particle density (g/cm^3).

Table with 2 columns: Property, Value. Rows include Gravimetric Moisture Content (% g/g), Volumetric Moisture Content (% vol), Dry bulk density (g/cm^3), Wet bulk density (g/cm^3), Calculated Porosity (% vol), and Percent Saturation.

Laboratory analysis by: K. Wright
Data entered by: C. Krous
Checked by: J. Hines

Comments:

- \* Weight including tares
NA = Not analyzed
--- = This sample was not remolded

## **Saturated Hydraulic Conductivity**



### Summary of Saturated Hydraulic Conductivity Tests

Sample Number	K <sub>sat</sub> (cm/sec)	Oversize Corrected K <sub>sat</sub> (cm/sec)	Method of Analysis	
			Constant Head	Falling Head
Blend 1 (38%)	7.4E-05	NA	X	
Blend 1 (45%)	1.4E-04	NA	X	
Blend 1 (55%)	4.9E-04	NA	X	
Blend 2 (39%)	2.4E-04	NA	X	
Blend 2 (45%)	5.2E-04	NA	X	
Blend 2 (55%)	1.4E-03	NA	X	
Blend 3 (40%)	6.9E-04	NA	X	
Blend 3 (45%)	2.0E-03	NA	X	
Blend 3 (55%)	1.6E-03	NA	X	
Blend 4 (44%)	3.7E-03	NA	X	
Blend 4 (50%)	3.9E-03	NA	X	
Blend 4 (55%)	9.8E-03	NA	X	

--- = Oversize correction is unnecessary since coarse fraction < 5% of composite mass  
 NR = Not requested  
 NA = Not applicable



### Saturated Hydraulic Conductivity Constant Head Method

Job name: Barr Engineering Company      Type of water used: TAP  
 Job number: LB10.0170.00      Collection vessel tare (g): 10.95  
 Sample number: Blend 1 (38%)      Sample length (cm): 7.57  
 Ring Number: NA      Sample diameter (cm): 4.90  
 Depth: NA      Sample x-sectional area (cm<sup>2</sup>): 18.89

Date	Time	Temp (°C)	Head (cm)	Q + Tare (g)	Q (cm <sup>3</sup> )	Elapsed time (sec)	Ksat (cm/sec)	Ksat @ 20°C (cm/sec)
Test # 1:								
27-Aug-10	9:09:40	22.0	12.5	12.42	1.5	617	7.6E-05	7.3E-05
27-Aug-10	9:19:57							
Test # 2:								
27-Aug-10	11:02:28	22.0	12.2	12.57	1.6	689	7.7E-05	7.4E-05
27-Aug-10	11:13:57							
Test # 3:								
27-Aug-10	11:44:57	22.0	12	11.93	1.0	415	7.9E-05	7.5E-05
27-Aug-10	11:51:52							

**Average Ksat (cm/sec): 7.4E-05**  
**Oversize Corrected Ksat (cm/sec): NA**

**Comments:**

- = Oversize correction is unnecessary since coarse fraction < 5% of composite mass
- NA = Not applicable

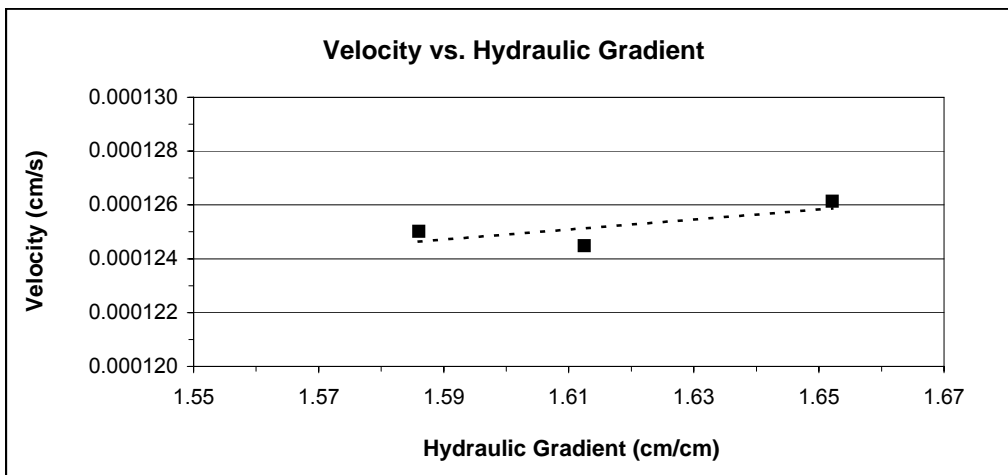

Laboratory analysis by: K. Wright  
 Data entered by: K. Wright  
 Checked by: J. Hines



### Saturated Hydraulic Conductivity Constant Head Method

Job name: Barr Engineering Company      Type of water used: TAP  
 Job number: LB10.0170.00      Collection vessel tare (g): 11.00  
 Sample number: Blend 1 (45%)      Sample length (cm): 7.54  
 Ring Number: NA      Sample diameter (cm): 4.93  
 Depth: NA      Sample x-sectional area (cm<sup>2</sup>): 19.06

Date	Time	Temp (°C)	Head (cm)	Q + Tare (g)	Q (cm <sup>3</sup> )	Elapsed time (sec)	Ksat (cm/sec)	Ksat @ 20°C (cm/sec)
Test # 1:								
27-Aug-10	10:12:58	22.0	12.8	14.15	3.2	651	1.5E-04	1.4E-04
27-Aug-10	10:23:49							
Test # 2:								
27-Aug-10	11:02:49	22.0	12.5	13.13	2.1	448	1.5E-04	1.4E-04
27-Aug-10	11:10:17							
Test # 3:								
27-Aug-10	11:45:18	22.0	12.3	13.25	2.3	486	1.5E-04	1.4E-04
27-Aug-10	11:53:24							

**Average Ksat (cm/sec): 1.4E-04**  
**Oversize Corrected Ksat (cm/sec): NA**

**Comments:**

- = Oversize correction is unnecessary since coarse fraction < 5% of composite mass
- NA = Not applicable

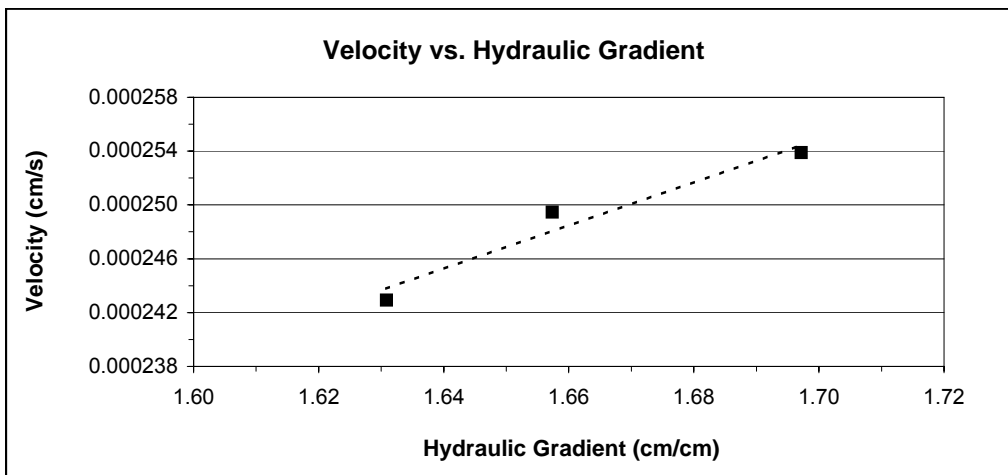

Laboratory analysis by: K. Wright  
 Data entered by: K. Wright  
 Checked by: J. Hines





### Saturated Hydraulic Conductivity Constant Head Method

Job name: Barr Engineering Company      Type of water used: TAP  
 Job number: LB10.0170.00      Collection vessel tare (g): 10.96  
 Sample number: Blend 1 (55%)      Sample length (cm): 7.41  
 Ring Number: NA      Sample diameter (cm): 4.91  
 Depth: NA      Sample x-sectional area (cm<sup>2</sup>): 18.95

Date	Time	Temp (°C)	Head (cm)	Q + Tare (g)	Q (cm <sup>3</sup> )	Elapsed time (sec)	Ksat (cm/sec)	Ksat @ 20°C (cm/sec)
Test # 1:								
31-Aug-10	11:17:19	22.0	2.2	12.22	1.3	435	5.1E-04	4.9E-04
31-Aug-10	11:24:34							
Test # 2:								
31-Aug-10	11:43:49	22.0	2.5	13.25	2.3	695	5.2E-04	4.9E-04
31-Aug-10	11:55:24							
Test # 3:								
31-Aug-10	13:05:26	22.5	2.7	13.16	2.2	638	5.0E-04	4.7E-04
31-Aug-10	13:16:04							

**Average Ksat (cm/sec): 4.9E-04**  
**Oversize Corrected Ksat (cm/sec): NA**

**Comments:**

--- = Oversize correction is unnecessary since coarse fraction < 5% of composite mass  
 NA = Not applicable

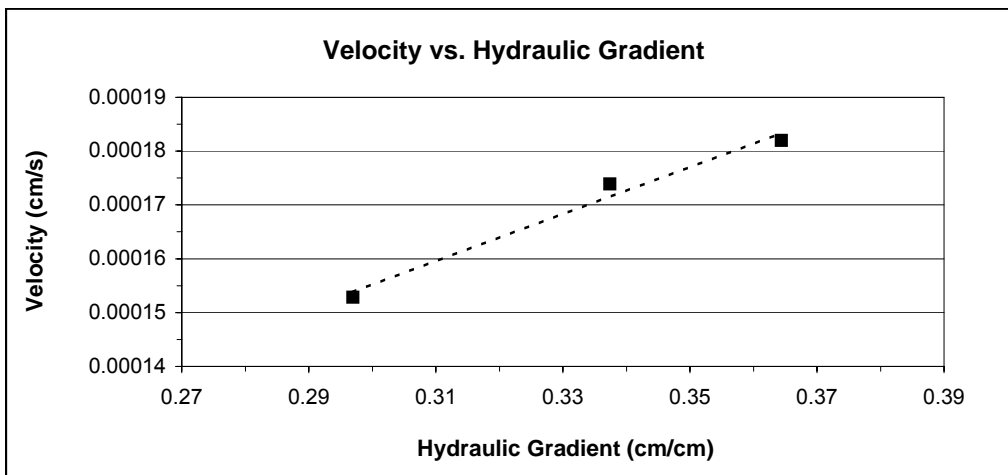

Laboratory analysis by: K. Wright  
 Data entered by: K. Wright  
 Checked by: J. Hines



### Saturated Hydraulic Conductivity Constant Head Method

Job name: Barr Engineering Company      Type of water used: TAP  
 Job number: LB10.0170.00      Collection vessel tare (g): 11.01  
 Sample number: Blend 2 (39%)      Sample length (cm): 7.74  
 Ring Number: NA      Sample diameter (cm): 4.92  
 Depth: NA      Sample x-sectional area (cm<sup>2</sup>): 19.00

Date	Time	Temp (°C)	Head (cm)	Q + Tare (g)	Q (cm <sup>3</sup> )	Elapsed time (sec)	Ksat (cm/sec)	Ksat @ 20°C (cm/sec)
Test # 1:								
31-Aug-10	11:01:35	22.0	6.9	13.55	2.5	590	2.5E-04	2.4E-04
31-Aug-10	11:11:25							
Test # 2:								
31-Aug-10	11:43:55	22.0	6.7	13.14	2.1	524	2.5E-04	2.4E-04
31-Aug-10	11:52:39							
Test # 3:								
31-Aug-10	12:22:20	22.0	6.5	12.60	1.6	386	2.6E-04	2.5E-04
31-Aug-10	12:28:46							

**Average Ksat (cm/sec): 2.4E-04**  
**Oversize Corrected Ksat (cm/sec): NA**

**Comments:**

- = Oversize correction is unnecessary since coarse fraction < 5% of composite mass
- NA = Not applicable

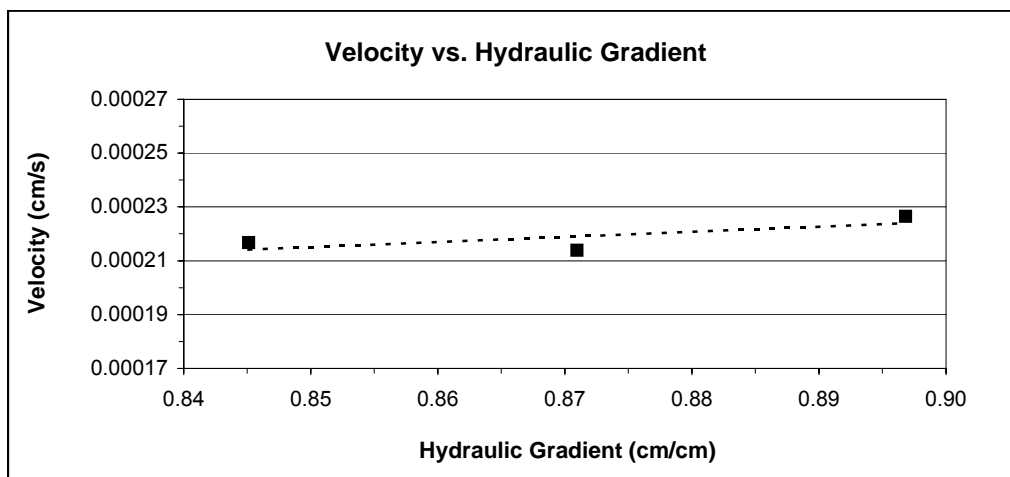

Laboratory analysis by: K. Wright  
 Data entered by: K. Wright  
 Checked by: J. Hines



### Saturated Hydraulic Conductivity Constant Head Method

Job name: Barr Engineering Company      Type of water used: TAP  
 Job number: LB10.0170.00      Collection vessel tare (g): 10.95  
 Sample number: Blend 2 (45%)      Sample length (cm): 7.62  
 Ring Number: NA      Sample diameter (cm): 4.84  
 Depth: NA      Sample x-sectional area (cm<sup>2</sup>): 18.38

Date	Time	Temp (°C)	Head (cm)	Q + Tare (g)	Q (cm <sup>3</sup> )	Elapsed time (sec)	Ksat (cm/sec)	Ksat @ 20°C (cm/sec)
Test # 1:								
27-Aug-10	11:01:12	22.0	6.4	15.28	4.3	508	5.5E-04	5.3E-04
27-Aug-10	11:09:40							
Test # 2:								
27-Aug-10	11:43:20	22.0	6.2	13.49	2.5	308	5.5E-04	5.3E-04
27-Aug-10	11:48:28							
Test # 3:								
27-Aug-10	15:25:56	22.0	6	14.10	3.2	400	5.4E-04	5.2E-04
27-Aug-10	15:32:36							

**Average Ksat (cm/sec): 5.2E-04**  
**Oversize Corrected Ksat (cm/sec): NA**

**Comments:**

- = Oversize correction is unnecessary since coarse fraction < 5% of composite mass
- NA = Not applicable

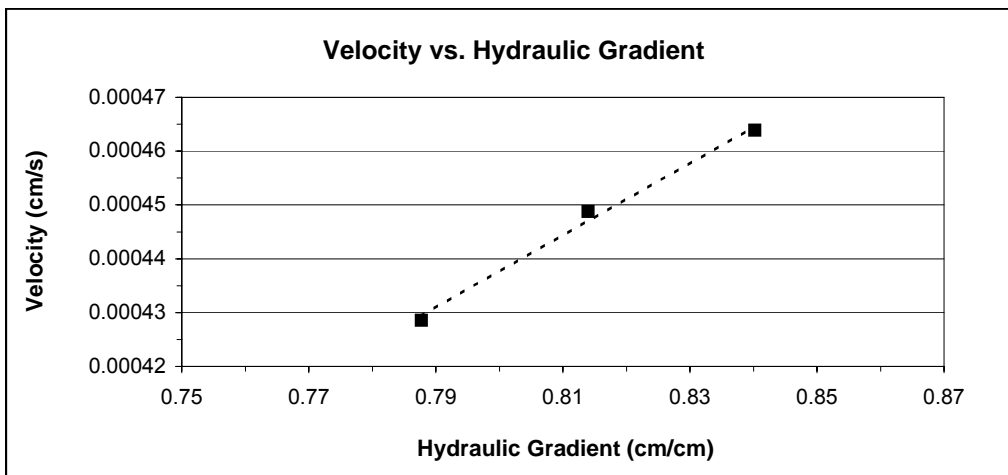

Laboratory analysis by: K. Wright  
 Data entered by: K. Wright  
 Checked by: J. Hines



### Saturated Hydraulic Conductivity Constant Head Method

Job name: Barr Engineering Company      Type of water used: TAP  
 Job number: LB10.0170.00      Collection vessel tare (g): 10.93  
 Sample number: Blend 2 (55%)      Sample length (cm): 7.61  
 Ring Number: NA      Sample diameter (cm): 4.86  
 Depth: NA      Sample x-sectional area (cm<sup>2</sup>): 18.51

Date	Time	Temp (°C)	Head (cm)	Q + Tare (g)	Q (cm <sup>3</sup> )	Elapsed time (sec)	Ksat (cm/sec)	Ksat @ 20°C (cm/sec)
Test # 1:								
31-Aug-10	10:52:46	22.0	3.6	14.00	3.1	230	1.5E-03	1.5E-03
31-Aug-10	10:56:36							
Test # 2:								
31-Aug-10	11:18:00	22.0	3.4	13.86	2.9	246	1.4E-03	1.4E-03
31-Aug-10	11:22:06							
Test # 3:								
31-Aug-10	11:43:30	22.0	3	17.38	6.5	611	1.4E-03	1.4E-03
31-Aug-10	11:53:41							

**Average Ksat (cm/sec): 1.4E-03**  
**Oversize Corrected Ksat (cm/sec): NA**

**Comments:**

- = Oversize correction is unnecessary since coarse fraction < 5% of composite mass
- NA = Not applicable

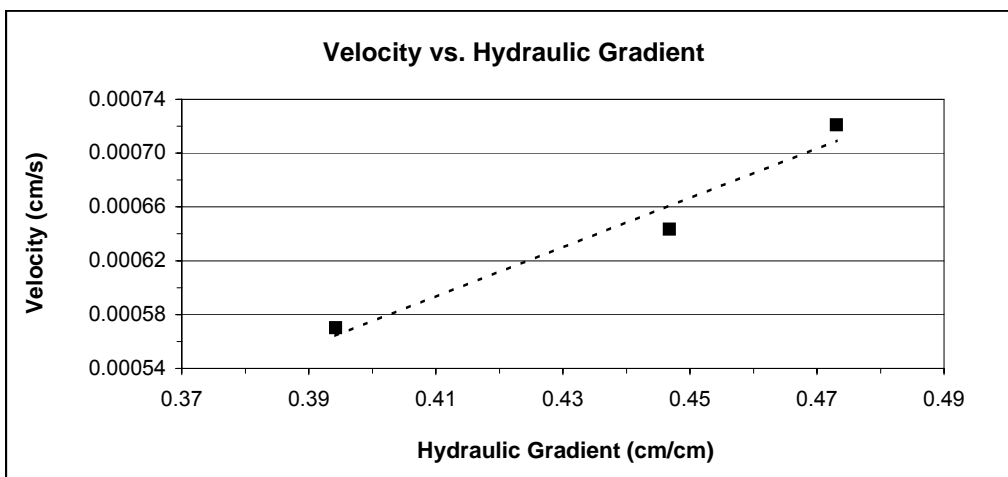

Laboratory analysis by: K. Wright  
 Data entered by: K. Wright  
 Checked by: J. Hines



### Saturated Hydraulic Conductivity Constant Head Method

Job name: Barr Engineering Company      Type of water used: TAP  
 Job number: LB10.0170.00      Collection vessel tare (g): 10.92  
 Sample number: Blend 3 (40%)      Sample length (cm): 7.58  
 Ring Number: NA      Sample diameter (cm): 4.91  
 Depth: NA      Sample x-sectional area (cm<sup>2</sup>): 18.90

Date	Time	Temp (°C)	Head (cm)	Q + Tare (g)	Q (cm <sup>3</sup> )	Elapsed time (sec)	Ksat (cm/sec)	Ksat @ 20°C (cm/sec)
Test # 1:								
27-Aug-10	10:10:51	22.0	4	14.25	3.3	462	7.2E-04	6.9E-04
27-Aug-10	10:18:33							
Test # 2:								
27-Aug-10	11:01:00	22.0	3.8	14.13	3.2	470	7.2E-04	6.9E-04
27-Aug-10	11:08:50							
Test # 3:								
27-Aug-10	11:42:58	22.0	3.6	13.30	2.4	369	7.2E-04	6.9E-04
27-Aug-10	11:49:07							

**Average Ksat (cm/sec): 6.9E-04**  
**Oversize Corrected Ksat (cm/sec): NA**

**Comments:**

--- = Oversize correction is unnecessary since coarse fraction < 5% of composite mass  
 NA = Not applicable

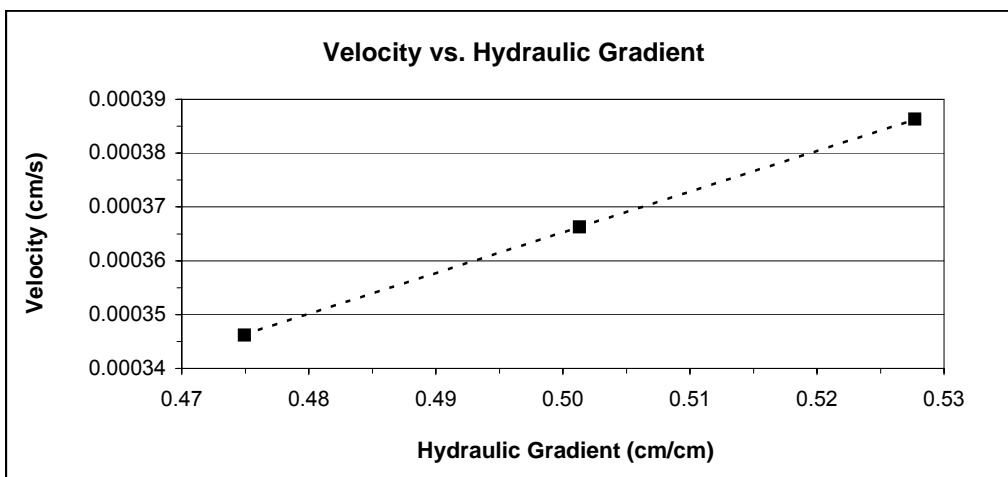

Laboratory analysis by: K. Wright  
 Data entered by: K. Wright  
 Checked by: J. Hines



### Saturated Hydraulic Conductivity Constant Head Method

Job name: Barr Engineering Company      Type of water used: TAP  
 Job number: LB10.0170.00      Collection vessel tare (g): 10.98  
 Sample number: Blend 3 (45%)      Sample length (cm): 7.56  
 Ring Number: NA      Sample diameter (cm): 4.90  
 Depth: NA      Sample x-sectional area (cm<sup>2</sup>): 18.89

Date	Time	Temp (°C)	Head (cm)	Q + Tare (g)	Q (cm <sup>3</sup> )	Elapsed time (sec)	Ksat (cm/sec)	Ksat @ 20°C (cm/sec)
Test # 1:								
27-Aug-10	10:10:37	22.0	3.5	20.69	9.7	527	2.1E-03	2.0E-03
27-Aug-10	10:19:24							
Test # 2:								
27-Aug-10	11:00:49	22.0	3.3	18.71	7.7	449	2.1E-03	2.0E-03
27-Aug-10	11:08:18							
Test # 3:								
27-Aug-10	11:42:34	22.0	3.1	15.43	4.5	278	2.1E-03	2.0E-03
27-Aug-10	11:47:12							

Average Ksat (cm/sec): 2.0E-03  
 Oversize Corrected Ksat (cm/sec): NA

**Comments:**

- = Oversize correction is unnecessary since coarse fraction < 5% of composite mass
- NA = Not applicable

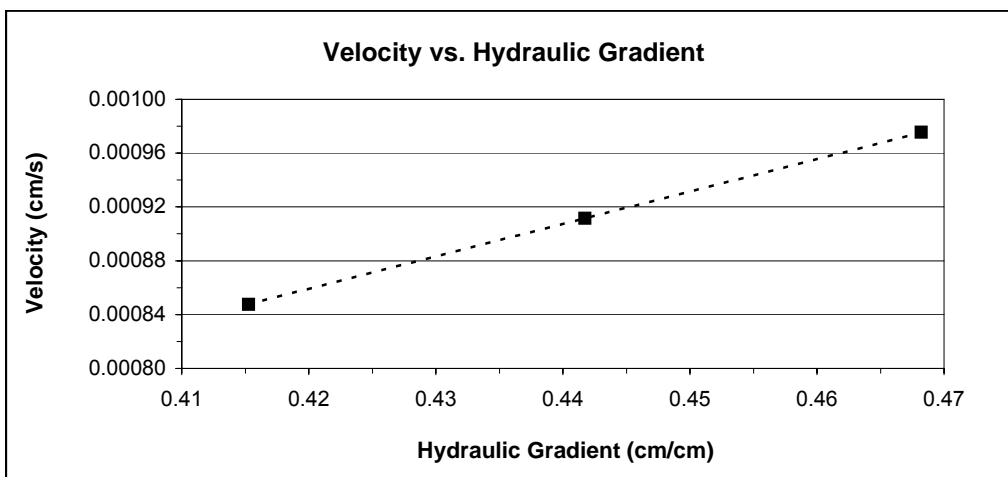

Laboratory analysis by: K. Wright  
 Data entered by: K. Wright  
 Checked by: J. Hines



### Saturated Hydraulic Conductivity Constant Head Method

Job name: Barr Engineering Company      Type of water used: TAP  
 Job number: LB10.0170.00      Collection vessel tare (g): 10.96  
 Sample number: Blend 3 (55%)      Sample length (cm): 7.71  
 Ring Number: NA      Sample diameter (cm): 4.92  
 Depth: NA      Sample x-sectional area (cm<sup>2</sup>): 18.99

Date	Time	Temp (°C)	Head (cm)	Q + Tare (g)	Q (cm <sup>3</sup> )	Elapsed time (sec)	Ksat (cm/sec)	Ksat @ 20°C (cm/sec)
Test # 1:								
27-Aug-10	10:11:45	22.0	3.6	15.80	4.8	327	1.7E-03	1.6E-03
27-Aug-10	10:17:12							
Test # 2:								
27-Aug-10	11:01:59	22.0	3.1	14.96	4.0	301	1.7E-03	1.7E-03
27-Aug-10	11:07:00							
Test # 3:								
27-Aug-10	11:44:18	22.0	3.2	15.18	4.2	359	1.5E-03	1.4E-03
27-Aug-10	11:50:17							

Average Ksat (cm/sec): 1.6E-03  
 Oversize Corrected Ksat (cm/sec): NA

**Comments:**

- = Oversize correction is unnecessary since coarse fraction < 5% of composite mass
- NA = Not applicable

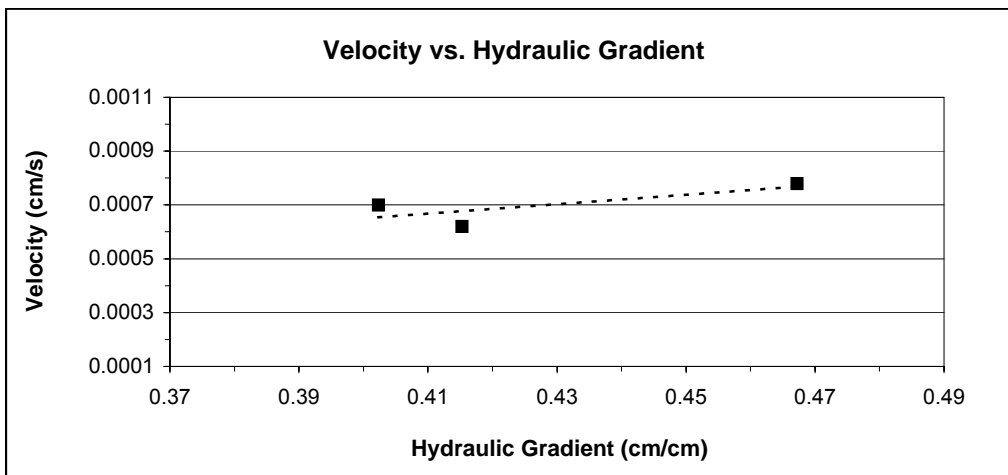

Laboratory analysis by: K. Wright  
 Data entered by: K. Wright  
 Checked by: J. Hines



### Saturated Hydraulic Conductivity Constant Head Method

Job name: Barr Engineering Company      Type of water used: TAP  
 Job number: LB10.0170.00      Collection vessel tare (g): 10.92  
 Sample number: Blend 4 (44%)      Sample length (cm): 7.57  
 Ring Number: NA      Sample diameter (cm): 4.93  
 Depth: NA      Sample x-sectional area (cm<sup>2</sup>): 19.09

Date	Time	Temp (°C)	Head (cm)	Q + Tare (g)	Q (cm <sup>3</sup> )	Elapsed time (sec)	Ksat (cm/sec)	Ksat @ 20°C (cm/sec)
Test # 1:								
27-Aug-10	10:12:47	22.0	2.6	17.01	6.1	231	4.0E-03	3.8E-03
27-Aug-10	10:16:38							
Test # 2:								
27-Aug-10	11:02:38	22.0	2.4	15.91	5.0	216	3.8E-03	3.6E-03
27-Aug-10	11:06:14							
Test # 3:								
27-Aug-10	11:45:06	22.0	2.2	16.81	5.9	278	3.8E-03	3.6E-03
27-Aug-10	11:49:44							

**Average Ksat (cm/sec): 3.7E-03**  
**Oversize Corrected Ksat (cm/sec): NA**

**Comments:**

- = Oversize correction is unnecessary since coarse fraction < 5% of composite mass
- NA = Not applicable

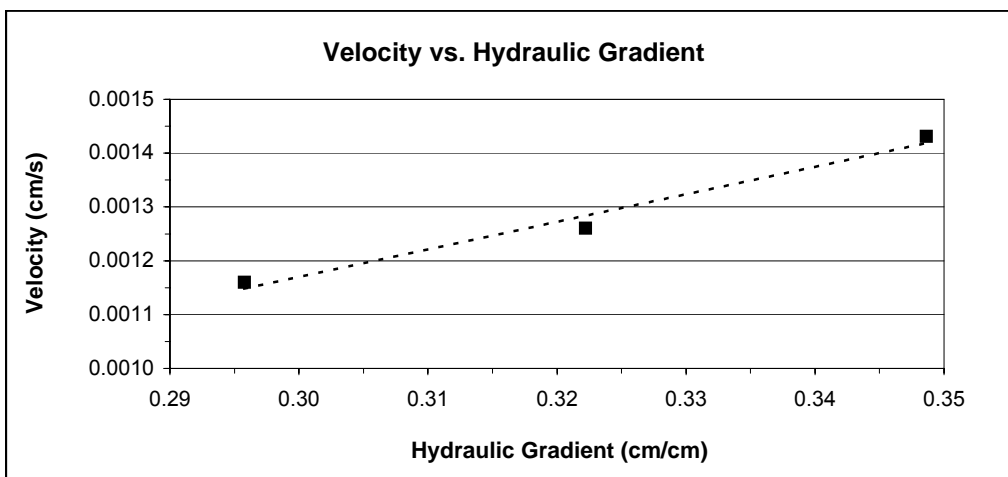

Laboratory analysis by: K. Wright  
 Data entered by: K. Wright  
 Checked by: J. Hines





### Saturated Hydraulic Conductivity Constant Head Method

Job name: Barr Engineering Company	Type of water used: TAP
Job number: LB10.0170.00	Collection vessel tare (g): 10.94
Sample number: Blend 4 (50%)	Sample length (cm): 7.61
Ring Number: NA	Sample diameter (cm): 4.91
Depth: NA	Sample x-sectional area (cm <sup>2</sup> ): 18.90

Date	Time	Temp (°C)	Head (cm)	Q + Tare (g)	Q (cm <sup>3</sup> )	Elapsed time (sec)	Ksat (cm/sec)	Ksat @ 20°C (cm/sec)
Test # 1:								
13-Sep-10	10:01:53	22.0	3.5	20.27	9.3	268	4.0E-03	3.8E-03
13-Sep-10	10:06:21							
Test # 2:								
13-Sep-10	10:29:52	22.0	3.3	18.92	8.0	244	4.0E-03	3.8E-03
13-Sep-10	10:33:56							
Test # 3:								
13-Sep-10	10:54:06	22.0	3	17.64	6.7	216	4.2E-03	4.0E-03
13-Sep-10	10:57:42							

Average Ksat (cm/sec): 3.9E-03  
Oversize Corrected Ksat (cm/sec): NA

**Comments:**

- = Oversize correction is unnecessary since coarse fraction < 5% of composite mass
- NA = Not applicable

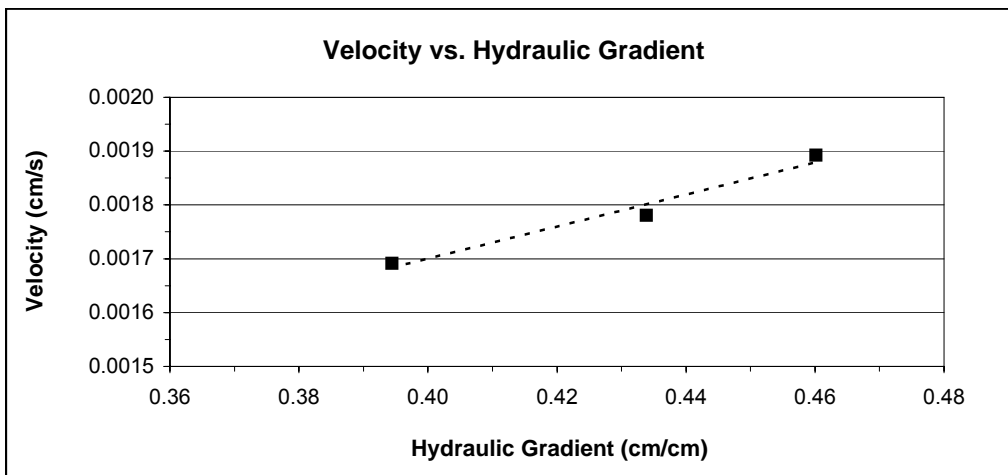

Laboratory analysis by: K. Wright  
Data entered by: K. Wright  
Checked by: J. Hines



### Saturated Hydraulic Conductivity Constant Head Method

Job name: Barr Engineering Company	Type of water used: TAP
Job number: LB10.0170.00	Collection vessel tare (g): 10.93
Sample number: Blend 4 (55%)	Sample length (cm): 7.63
Ring Number: NA	Sample diameter (cm): 4.91
Depth: NA	Sample x-sectional area (cm <sup>2</sup> ): 18.91

Date	Time	Temp (°C)	Head (cm)	Q + Tare (g)	Q (cm <sup>3</sup> )	Elapsed time (sec)	Ksat (cm/sec)	Ksat @ 20°C (cm/sec)
Test # 1:								
13-Sep-10	10:02:00	22.0	3.2	26.89	16.0	208	9.7E-03	9.2E-03
13-Sep-10	10:05:28							
Test # 2:								
13-Sep-10	10:30:02	22.0	2.8	23.15	12.2	170	1.0E-02	9.9E-03
13-Sep-10	10:32:52							
Test # 3:								
13-Sep-10	10:54:14	22.0	2.5	21.68	10.8	162	1.1E-02	1.0E-02
13-Sep-10	10:56:56							

Average Ksat (cm/sec): 9.8E-03  
 Oversize Corrected Ksat (cm/sec): NA

Comments:

- = Oversize correction is unnecessary since coarse fraction < 5% of composite mass
- NA = Not applicable

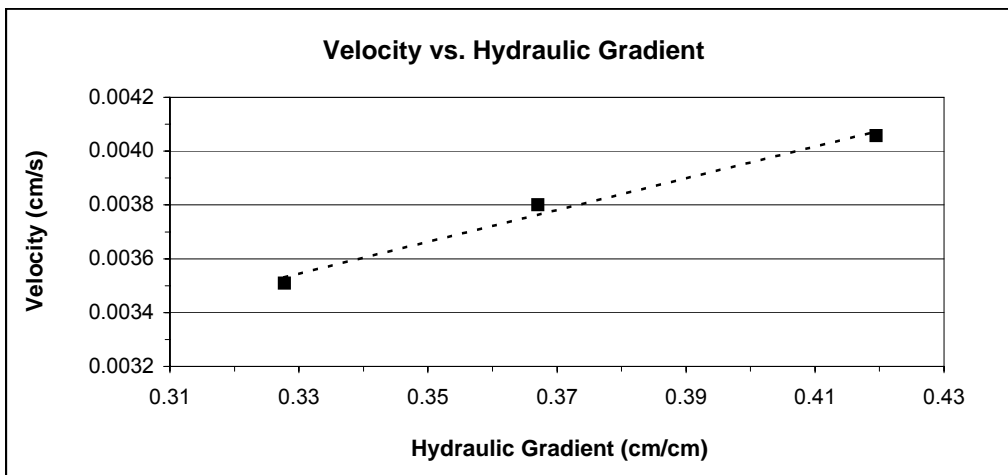

Laboratory analysis by: K. Wright  
 Data entered by: K. Wright  
 Checked by: J. Hines

## **Moisture Retention Characteristics**



### Summary of Moisture Characteristics of the Initial Drainage Curve

Sample Number	Pressure Head (-cm water)	Moisture Content (%, cm <sup>3</sup> /cm <sup>3</sup> )
Blend 1 (38%)	0	40.3
	17	39.9
	49	39.7
	123	39.7
	337	25.9
	14685	3.8
	38752	2.2
	124416	1.7
	861325	0.7
Blend 1 (45%)	0	45.0
	12	43.8
	31	42.8
	101	42.4 #
	337	25.9 #
	17439	3.9 #
	41200	2.5 #
	132268	1.3 #
	861325	0.7 #
Blend 1 (55%)	0	48.0 #
	12	40.8 #
	31	38.6 #
	101	37.4 #
	337	33.7 #
	17745	4.2 #
	44769	2.6 #
	109323	1.9 #
	861325	0.7 #

# Volume adjustments are applicable at this matric potential (see data sheet for this sample).



**Summary of Moisture Characteristics  
of the Initial Drainage Curve (Continued)**

Sample Number	Pressure Head (-cm water)	Moisture Content (%, cm <sup>3</sup> /cm <sup>3</sup> )
Blend 2 (39%)	0	39.9
	12	38.6
	31	38.2
	101	37.9
	337	16.9
	16419	2.5
	35489	1.8
	142772	1.3
	861325	0.6
Blend 2 (45%)	0	45.8 #
	12	43.5 #
	31	41.7 #
	101	40.2 #
	337	19.4 #
	14583	2.6 #
	35489	1.5 #
	126455	1.0 #
	861325	0.6 #
Blend 2 (55%)	0	46.6 #
	5	41.1 #
	21	39.4 #
	76	37.3 #
	337	21.6 #
	17541	2.9 #
	44565	1.7 #
	106875	1.4 #
	861325	0.7 #

# Volume adjustments are applicable at this matric potential (see data sheet for this sample).



**Summary of Moisture Characteristics  
of the Initial Drainage Curve (Continued)**

Sample Number	Pressure Head (-cm water)	Moisture Content (%, cm <sup>3</sup> /cm <sup>3</sup> )
Blend 3 (40%)	0	39.7
	12	39.1
	31	38.8
	101	27.0
	337	12.3
	16215	3.2
	36611	2.9
	138387	2.0
	861325	0.6
Blend 3 (45%)	0	44.9 #
	5	42.9 #
	21	41.5 #
	76	39.7 #
	337	12.1 #
	14481	2.0 #
	41098	1.3 #
	141752	0.9 #
	861325	0.6 #
Blend 3 (55%)	0	44.0 #
	5	38.7 #
	21	37.1 #
	76	36.7 #
	337	12.1 #
	12951	1.9 #
	34673	1.3 #
	123396	1.0 #
	861325	0.6 #

# Volume adjustments are applicable at this matric potential (see data sheet for this sample).



**Summary of Moisture Characteristics  
of the Initial Drainage Curve (Continued)**

Sample Number	Pressure Head (-cm water)	Moisture Content (%, cm <sup>3</sup> /cm <sup>3</sup> )
Blend 4 (44%)	0	43.1
	5	42.8
	21	42.5
	76	32.7
	337	5.3
	19274	1.2
	57619	0.9
	151440	0.7
	861325	0.5
Blend 4 (50%)	0	42.2 #
	6	42.1 #
	30	41.4 #
	71	26.3 #
	337	4.5 #
	16929	1.4 #
	46197	1.0 #
	265658	0.8 #
	861325	0.4 #
Blend 4 (55%)	0	41.6 #
	6	40.7 #
	30	39.8 #
	71	29.3 #
	337	4.7 #
	6323	2.0 #
	66695	0.6 #
	105345	0.7 #
	861325	0.5 #

# Volume adjustments are applicable at this matric potential (see data sheet for this sample).



### Summary of Calculated Unsaturated Hydraulic Properties

Sample Number	$\alpha$ (cm <sup>-1</sup> )	N (dimensionless)	$\theta_r$ (% vol)	$\theta_s$ (% vol)	Oversize Corrected	
					$\theta_r$ (% vol)	$\theta_s$ (% vol)
Blend 1 (38%)	0.0028	4.4060	2.10	39.97	NA	NA
Blend 1 (45%)	0.0037	2.3302	2.04	44.09	NA	NA
Blend 1 (55%)	0.0032	1.5352	0.00	42.21	NA	NA
Blend 2 (39%)	0.0039	3.4263	1.55	38.91	NA	NA
Blend 2 (45%)	0.0049	2.3810	1.36	43.86	NA	NA
Blend 2 (55%)	0.0097	1.5315	0.20	43.07	NA	NA
Blend 3 (40%)	0.0112	1.9686	2.08	39.94	NA	NA
Blend 3 (45%)	0.0065	2.6280	1.17	43.17	NA	NA
Blend 3 (55%)	0.0066	2.4829	1.18	40.08	NA	NA
Blend 4 (44%)	0.0106	2.7451	0.81	42.95	NA	NA
Blend 4 (50%)	0.0148	2.7336	1.07	42.67	NA	NA
Blend 4 (55%)	0.0127	2.6317	0.95	41.31	NA	NA

--- = Oversize correction is unnecessary since coarse fraction < 5% of composite mass  
 NR = Not requested  
 NA = Not applicable





**Moisture Retention Data**  
**Hanging Column / Pressure Plate**  
 (Soil-Water Characteristic Curve)

Job Name: Barr Engineering Company  
 Job Number: LB10.0170.00  
 Sample Number: Blend 1 (38%)  
 Ring Number: NA  
 Depth: NA

Dry wt. of sample (g): 264.49  
 Tare wt., ring (g): 88.69  
 Tare wt., screen & clamp (g): 26.14  
 Initial sample volume (cm<sup>3</sup>): 142.91  
 Initial dry bulk density (g/cm<sup>3</sup>): 1.85  
 Measured particle density (g/cm<sup>3</sup>): 2.99  
 Initial calculated total porosity (%): 38.07

	Date	Time	Weight* (g)	Matric Potential (-cm water)	Moisture Content † (% vol)
<i>Hanging column:</i>	2-Sep-10	16:20	436.88	0	40.28
	13-Sep-10	9:35	436.34	17.0	39.90
	19-Sep-10	9:05	436.09	49.0	39.72
	26-Sep-10	8:25	436.05	123.0	39.70
<i>Pressure plate:</i>	4-Oct-10	10:55	416.31	337	25.88

Volume Adjusted Data<sup>1</sup>

	Matric Potential (-cm water)	Adjusted Volume (cm <sup>3</sup> )	% Volume Change <sup>2</sup> (%)	Adjusted Density (g/cm <sup>3</sup> )	Adjusted Calculated Porosity (%)
<i>Hanging column:</i>	0.0	---	---	---	---
	17.0	---	---	---	---
	49.0	---	---	---	---
	123.0	---	---	---	---
<i>Pressure plate:</i>	337	---	---	---	---

**Comments:**

<sup>1</sup> Applicable if the sample experienced volume changes during testing. 'Volume Adjusted' values represent each of the volume change measurements obtained after saturated hydraulic conductivity testing and throughout hanging column/pressure plate testing. "---" indicates no volume changes occurred.

<sup>2</sup> Represents percent volume change from original sample volume. A '+' denotes measured sample swelling, a '-' denotes measured sample settling, and '---' denotes no volume change occurred.

\* Weight including tares

† Assumed density of water is 1.0 g/cm<sup>3</sup>

‡ Volume adjustments are applicable at this matric potential (see comment #1).

**Technician Notes:**

*Laboratory analysis by:* K. Wright  
*Data entered by:* K. Wright  
*Checked by:* J. Hines



**Moisture Retention Data**  
**Dew Point Potentiometer / Relative Humidity Box**  
 (Soil-Water Characteristic Curve)

Sample Number: Blend 1 (38%)

Initial sample bulk density (g/cm<sup>3</sup>): 1.85  
 Fraction of bulk sample used (<2.00mm fraction) (%): 100.00

Dry weight\* of dew point potentiometer sample (g): 152.68  
 Tare weight, jar (g): 119.36

	Date	Time	Weight* (g)	Water Potential (-cm water)	Moisture Content <sup>†</sup> (% vol)
Dew point potentiometer:	23-Sep-10	11:15	153.36	14685	3.78
	23-Sep-10	10:56	153.08	38752	2.22
	23-Sep-10	15:23	152.98	124416	1.67

Volume Adjusted Data<sup>1</sup>

	Water Potential (-cm water)	Adjusted Volume (cm <sup>3</sup> )	% Volume Change <sup>2</sup> (%)	Adjusted Density (g/cm <sup>3</sup> )	Adjusted Calc. Porosity (%)
Dew point potentiometer:	14685	---	---	---	---
	38752	---	---	---	---
	124416	---	---	---	---

Dry weight\* of relative humidity box sample (g): 66.13  
 Tare weight (g): 31.76

	Date	Time	Weight* (g)	Water Potential (-cm water)	Moisture Content <sup>†</sup> (% vol)
Relative humidity box:	16-Sep-10	10:45	66.27	861325	0.74

Volume Adjusted Data<sup>1</sup>

	Water Potential (-cm water)	Adjusted Volume (cm <sup>3</sup> )	% Volume Change <sup>2</sup> (%)	Adjusted Density (g/cm <sup>3</sup> )	Adjusted Calc. Porosity (%)
Relative humidity box:	861325	---	---	---	---

**Comments:**

<sup>1</sup> Applicable if the sample experienced volume changes during testing. 'Volume Adjusted' values represent the volume change measurements obtained after the last hanging column or pressure plate point. "----" indicates no volume changes occurred.

<sup>2</sup> Represents percent volume change from original sample volume. A '+' denotes measured sample swelling, a '-' denotes measured sample settling, and '---' denotes no volume change occurred.

\* Weight including tares

<sup>†</sup> Adjusted for >2.00mm (#10 sieve) material not used in DPP/RH testing. Assumed moisture content of material >2.00mm is zero, and assumed density of water is 1.0 g/cm<sup>3</sup>.

<sup>##</sup> Volume adjustments are applicable at this matric potential (see comment #1).

Laboratory analysis by: M. Vigil  
 Data entered by: K. Wright  
 Checked by: J. Hines



### Water Retention Data Points

Sample Number: Blend 1 (38%)

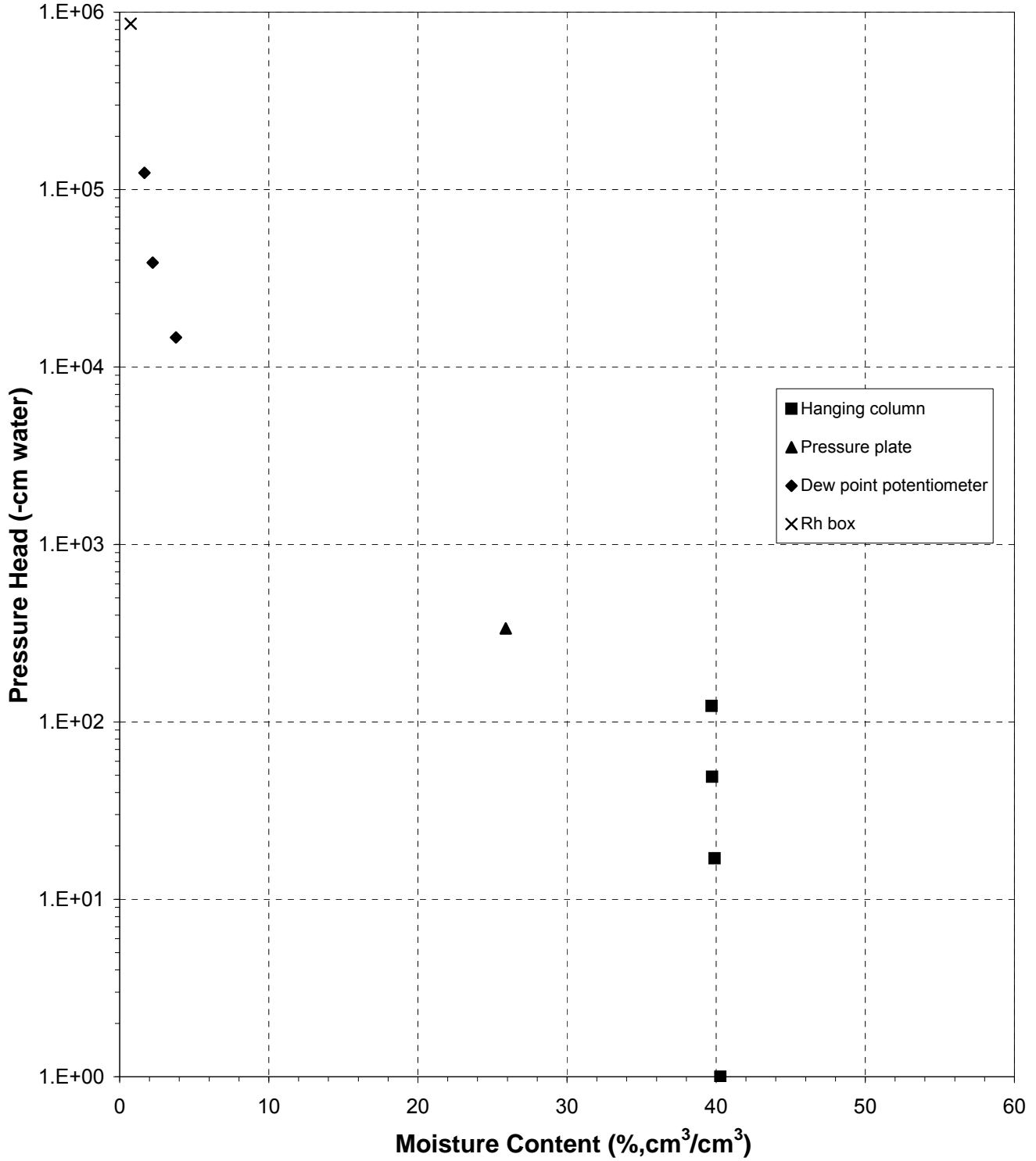



### Predicted Water Retention Curve and Data Points

Sample Number: Blend 1 (38%)

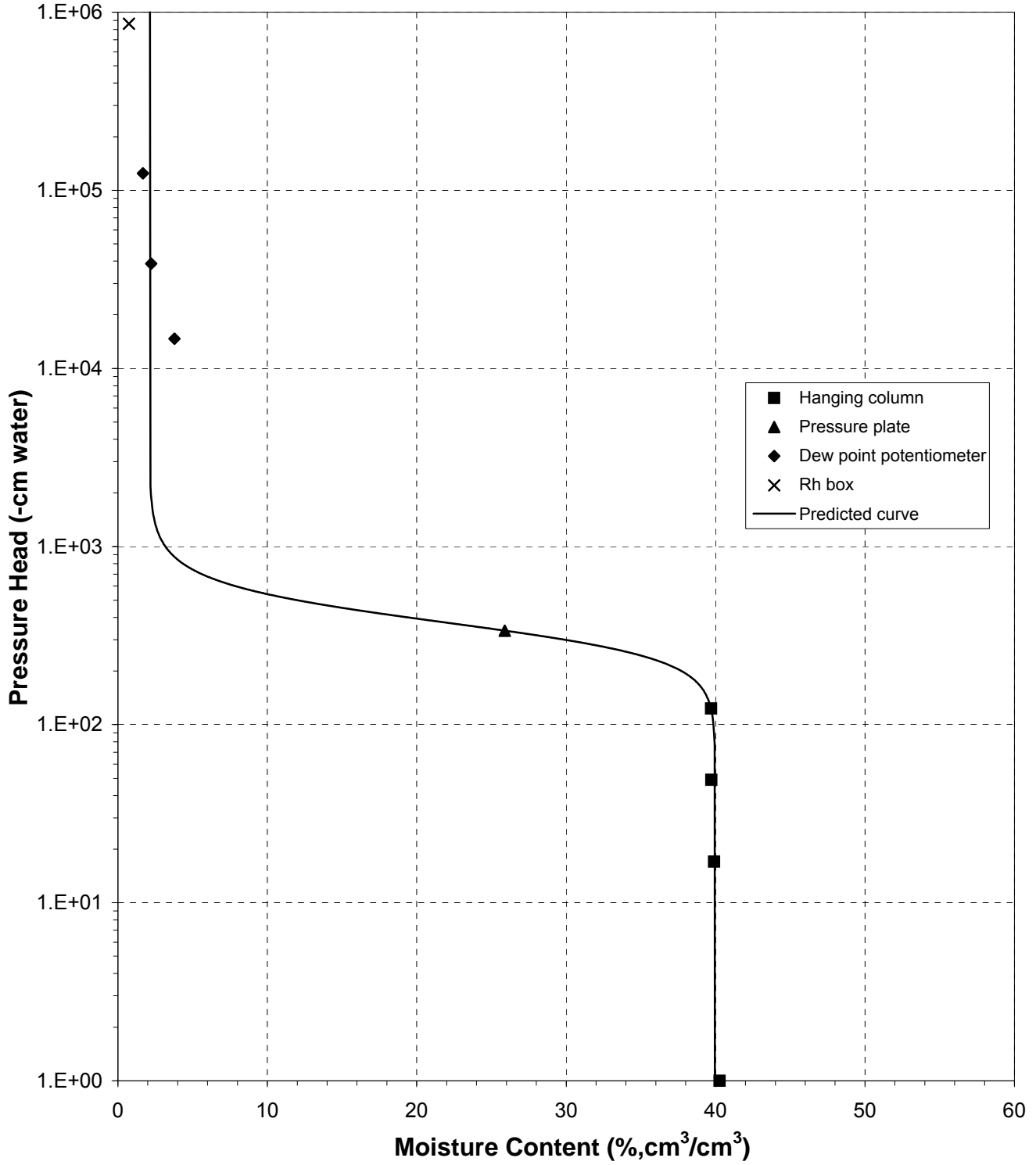



### Plot of Relative Hydraulic Conductivity vs Moisture Content

Sample Number: Blend 1 (38%)

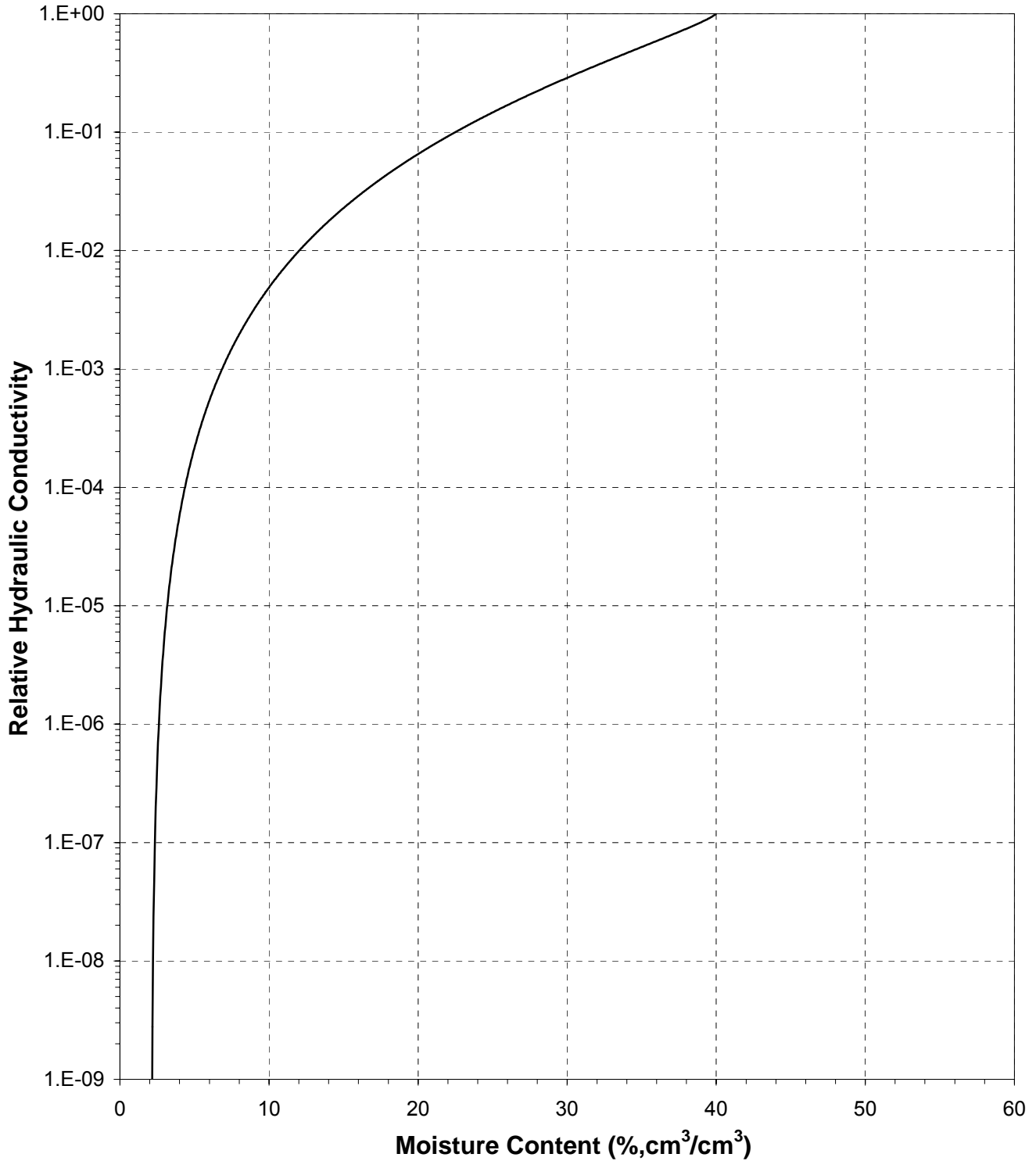



### Plot of Hydraulic Conductivity vs Moisture Content

Sample Number: Blend 1 (38%)

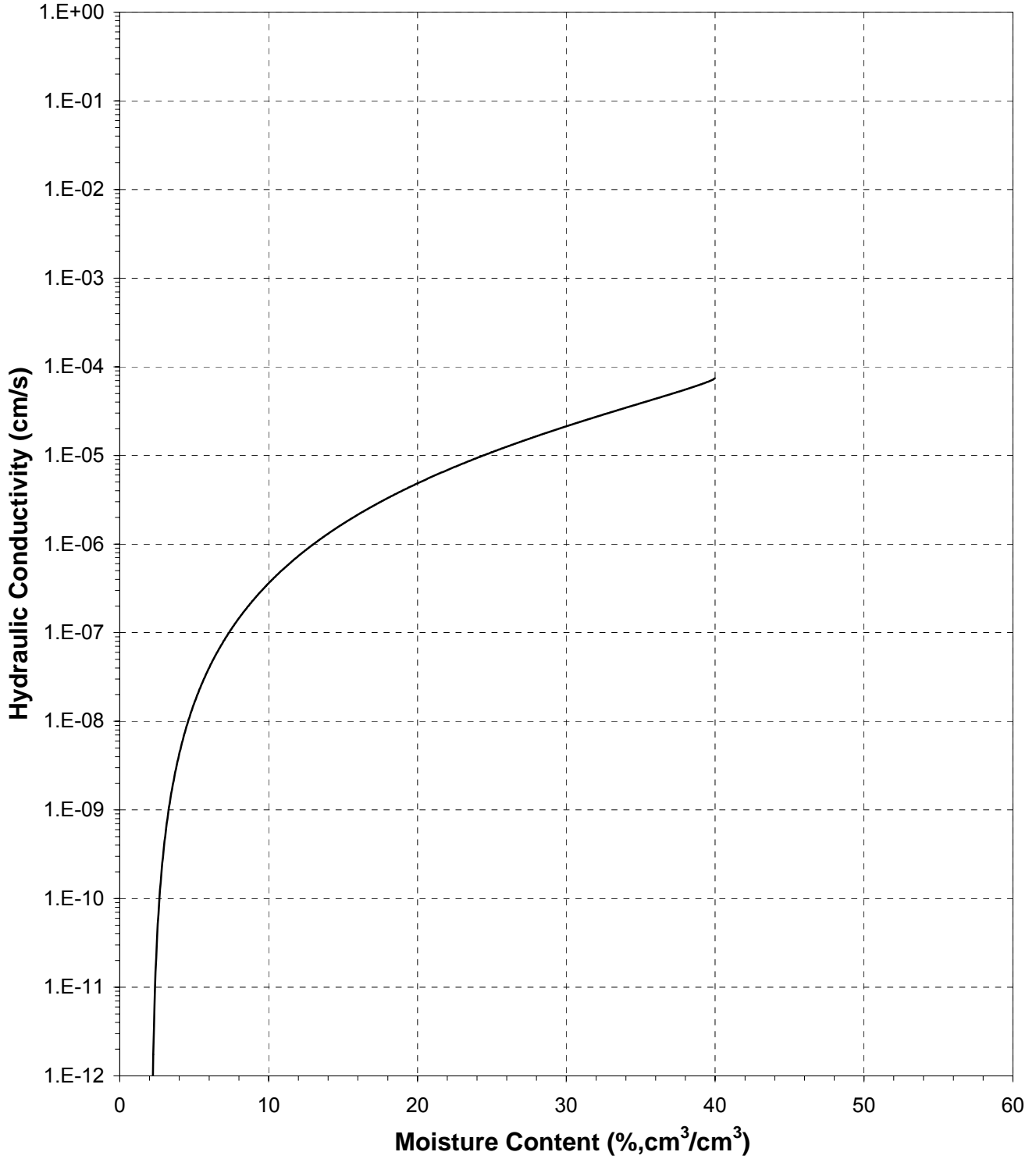



### Plot of Relative Hydraulic Conductivity vs Pressure Head

Sample Number: Blend 1 (38%)

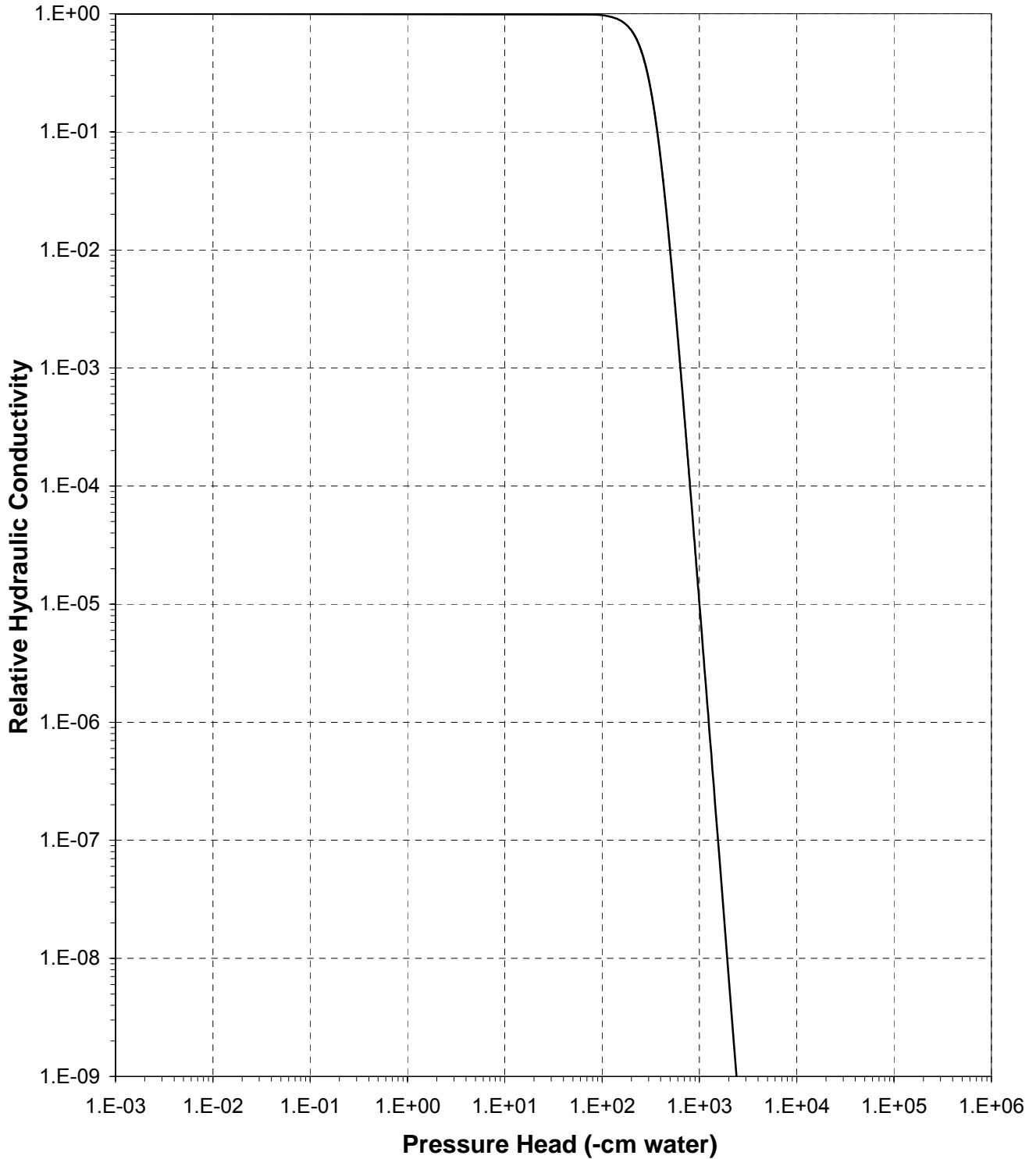



### Plot of Hydraulic Conductivity vs Pressure Head

Sample Number: Blend 1 (38%)

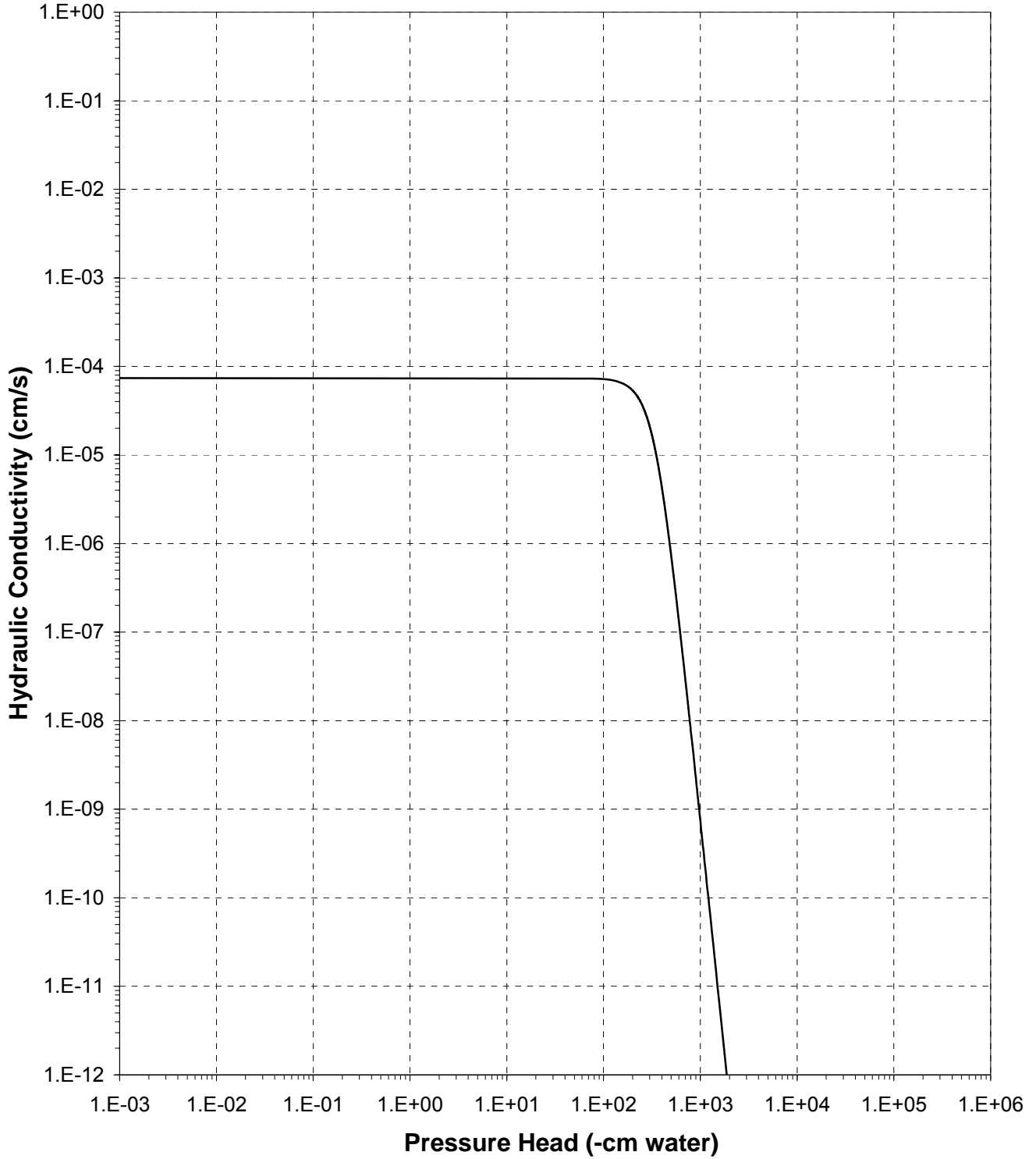





**Moisture Retention Data**  
**Hanging Column / Pressure Plate**  
 (Soil-Water Characteristic Curve)

Job Name: Barr Engineering Company  
 Job Number: LB10.0170.00  
 Sample Number: Blend 1 (45%)  
 Ring Number: NA  
 Depth: NA

Dry wt. of sample (g): 235.17  
 Tare wt., ring (g): 87.09  
 Tare wt., screen & clamp (g): 27.68  
 Initial sample volume (cm<sup>3</sup>): 143.74  
 Initial dry bulk density (g/cm<sup>3</sup>): 1.64  
 Measured particle density (g/cm<sup>3</sup>): 2.99  
 Initial calculated total porosity (%): 45.25

	Date	Time	Weight* (g)	Matric Potential (-cm water)	Moisture Content † (% vol)
<i>Hanging column:</i>	7-Sep-10	10:40	414.56	0	44.96
	13-Sep-10	10:25	412.95	12.0	43.84
	19-Sep-10	10:25	411.51	31.0	42.84
	26-Sep-10	8:50	408.89	101.0	42.37 ##
<i>Pressure plate:</i>	4-Oct-10	12:45	385.77	337	25.87 ##

Volume Adjusted Data <sup>1</sup>

	Matric Potential (-cm water)	Adjusted Volume (cm <sup>3</sup> )	% Volume Change <sup>2</sup> (%)	Adjusted Density (g/cm <sup>3</sup> )	Adjusted Calculated Porosity (%)
<i>Hanging column:</i>	0.0	---	---	---	---
	12.0	---	---	---	---
	31.0	---	---	---	---
	101.0	139.14	-3.20%	1.69	43.45
<i>Pressure plate:</i>	337	138.51	-3.63%	1.70	43.19

**Comments:**

<sup>1</sup> Applicable if the sample experienced volume changes during testing. 'Volume Adjusted' values represent each of the volume change measurements obtained after saturated hydraulic conductivity testing and throughout hanging column/pressure plate testing. "---" indicates no volume changes occurred.

<sup>2</sup> Represents percent volume change from original sample volume. A '+' denotes measured sample swelling, a '-' denotes measured sample settling, and '---' denotes no volume change occurred.

\* Weight including tares

† Assumed density of water is 1.0 g/cm<sup>3</sup>

## Volume adjustments are applicable at this matric potential (see comment #1).

**Technician Notes:**

*Laboratory analysis by:* K. Wright  
*Data entered by:* K. Wright  
*Checked by:* J. Hines



**Moisture Retention Data**  
**Dew Point Potentiometer / Relative Humidity Box**  
 (Soil-Water Characteristic Curve)

Sample Number: Blend 1 (45%)

Initial sample bulk density (g/cm<sup>3</sup>): 1.64  
 Fraction of bulk sample used (<2.00mm fraction) (%): 100.00

Dry weight\* of dew point potentiometer sample (g): 152.33  
 Tare weight, jar (g): 112.72

	Date	Time	Weight* (g)	Water Potential (-cm water)	Moisture Content <sup>†</sup> (% vol)	
Dew point potentiometer:	23-Sep-10	11:34	153.25	17439	3.94	##
	23-Sep-10	11:10	152.91	41200	2.49	##
	24-Sep-10	8:48	152.64	132268	1.33	##

Volume Adjusted Data<sup>1</sup>

	Water Potential (-cm water)	Adjusted Volume (cm <sup>3</sup> )	% Volume Change <sup>2</sup> (%)	Adjusted Density (g/cm <sup>3</sup> )	Adjusted Calc. Porosity (%)
Dew point potentiometer:	17439	138.51	-3.63%	1.70	43.19
	41200	138.51	-3.63%	1.70	43.19
	132268	138.51	-3.63%	1.70	43.19

Dry weight\* of relative humidity box sample (g): 71.84  
 Tare weight (g): 39.94

	Date	Time	Weight* (g)	Water Potential (-cm water)	Moisture Content <sup>†</sup> (% vol)	
Relative humidity box:	16-Sep-10	10:45	71.97	861325	0.67	##

Volume Adjusted Data<sup>1</sup>

	Water Potential (-cm water)	Adjusted Volume (cm <sup>3</sup> )	% Volume Change <sup>2</sup> (%)	Adjusted Density (g/cm <sup>3</sup> )	Adjusted Calc. Porosity (%)
Relative humidity box:	861325	138.51	-3.63%	1.70	43.19

**Comments:**

<sup>1</sup> Applicable if the sample experienced volume changes during testing. 'Volume Adjusted' values represent the volume change measurements obtained after the last hanging column or pressure plate point. "---" indicates no volume changes occurred.

<sup>2</sup> Represents percent volume change from original sample volume. A '+' denotes measured sample swelling, a '-' denotes measured sample settling, and '--' denotes no volume change occurred.

\* Weight including tares

<sup>†</sup> Adjusted for >2.00mm (#10 sieve) material not used in DPP/RH testing. Assumed moisture content of material >2.00mm is zero, and assumed density of water is 1.0 g/cm<sup>3</sup>.

## Volume adjustments are applicable at this matric potential (see comment #1).

Laboratory analysis by: M. Vigil  
 Data entered by: K. Wright  
 Checked by: J. Hines



### Water Retention Data Points

Sample Number: Blend 1 (45%)

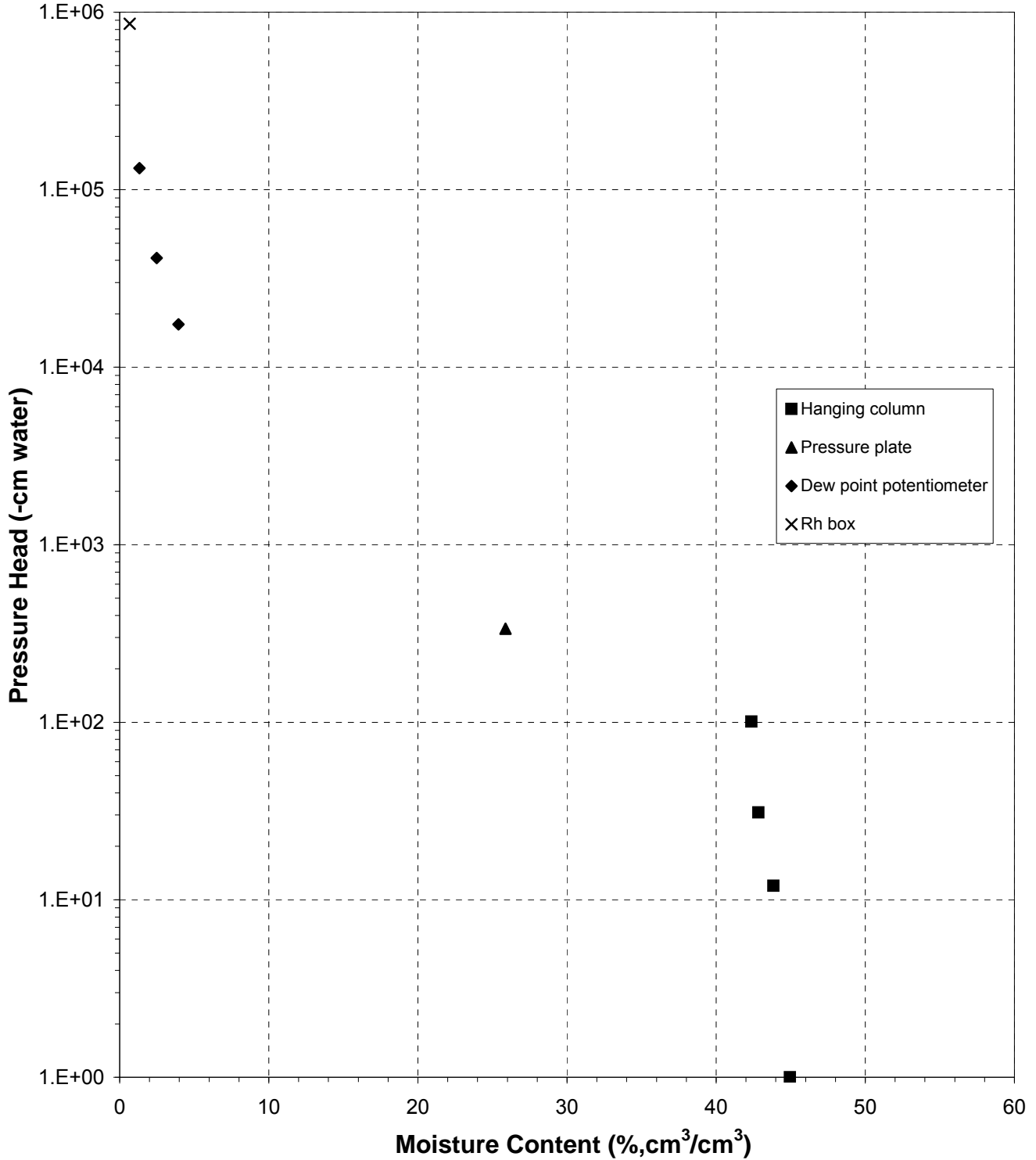



### Predicted Water Retention Curve and Data Points

Sample Number: Blend 1 (45%)

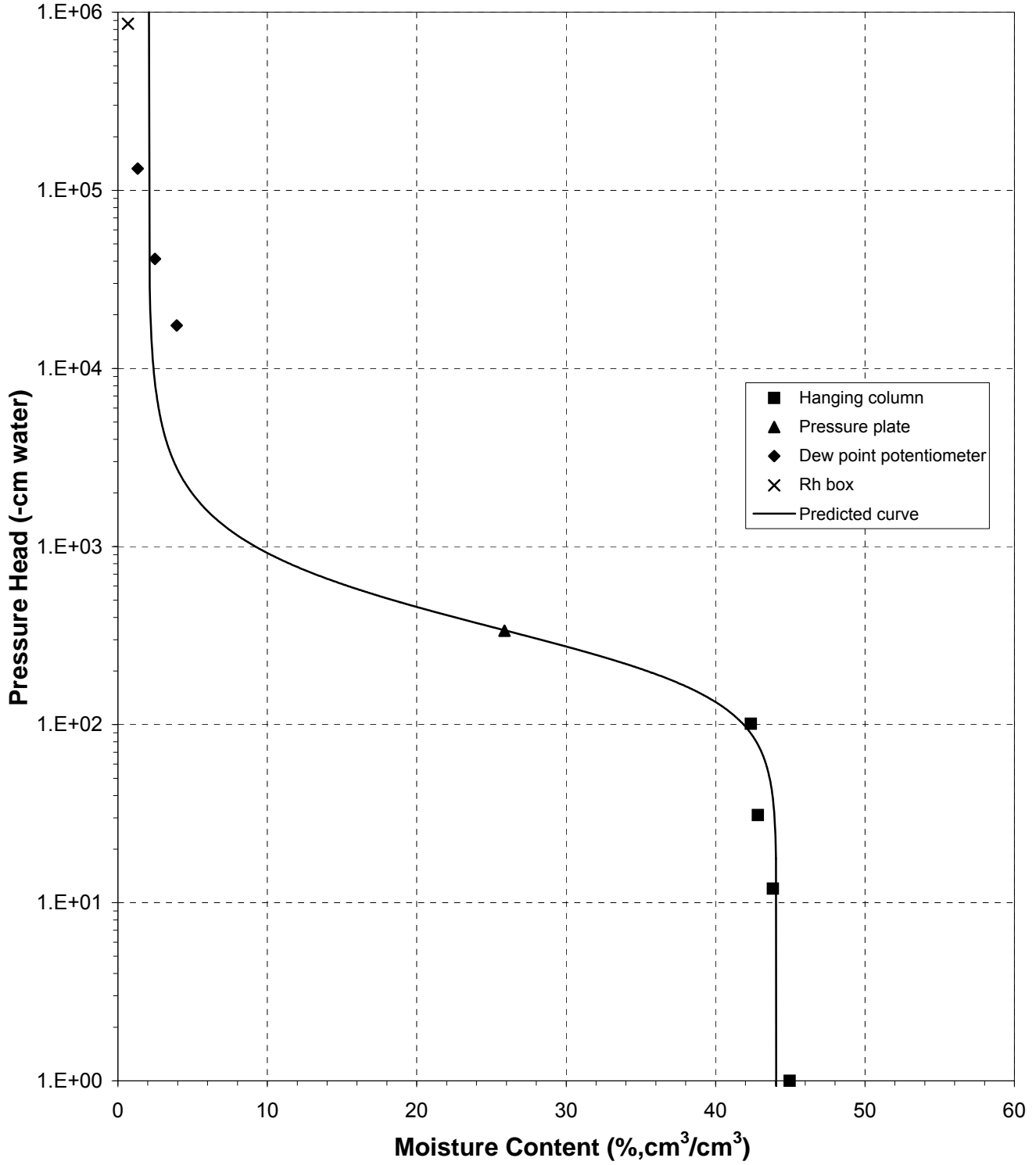



### Plot of Relative Hydraulic Conductivity vs Moisture Content

Sample Number: Blend 1 (45%)

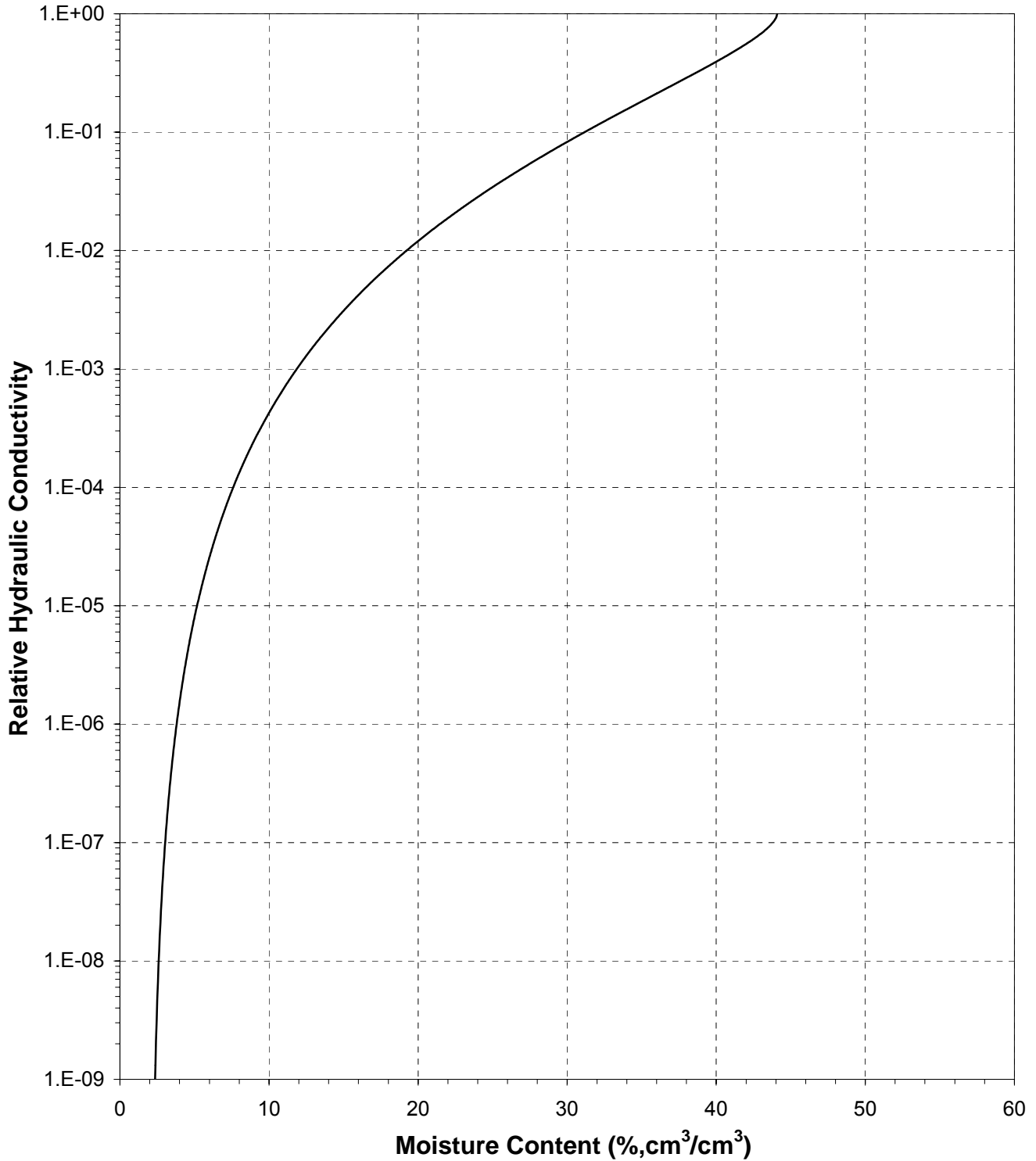



### Plot of Hydraulic Conductivity vs Moisture Content

Sample Number: Blend 1 (45%)

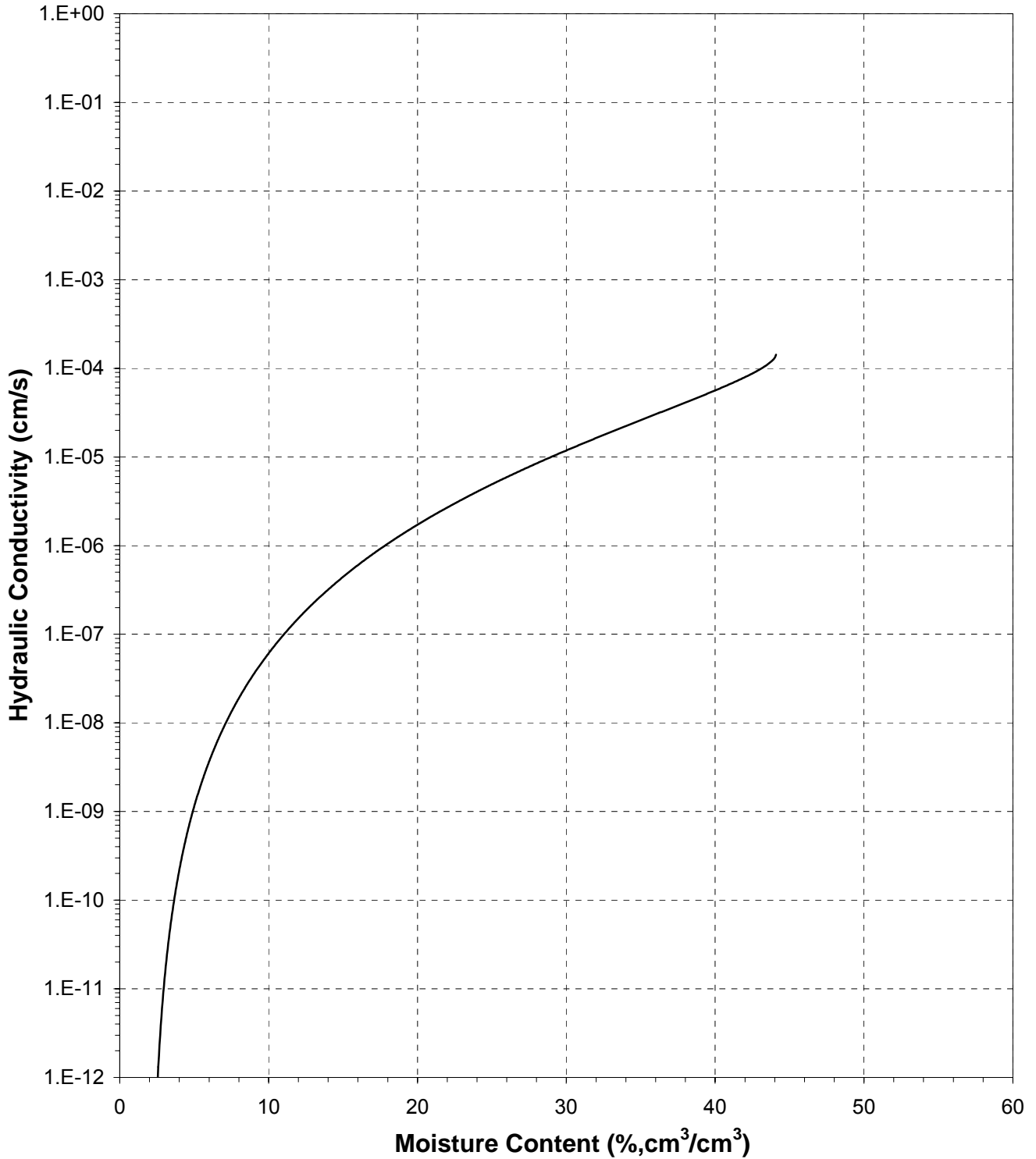



### Plot of Relative Hydraulic Conductivity vs Pressure Head

Sample Number: Blend 1 (45%)

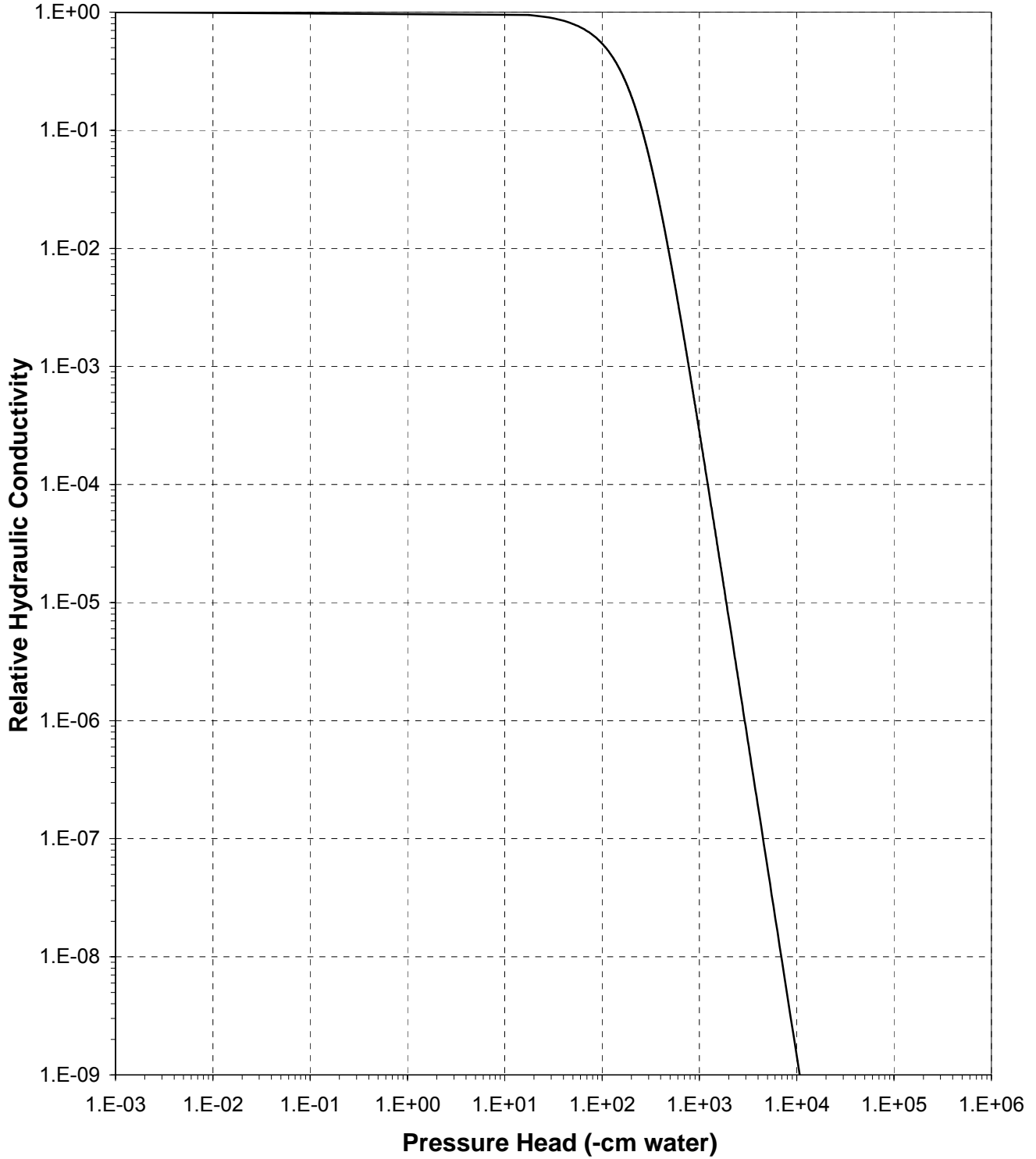



### Plot of Hydraulic Conductivity vs Pressure Head

Sample Number: Blend 1 (45%)

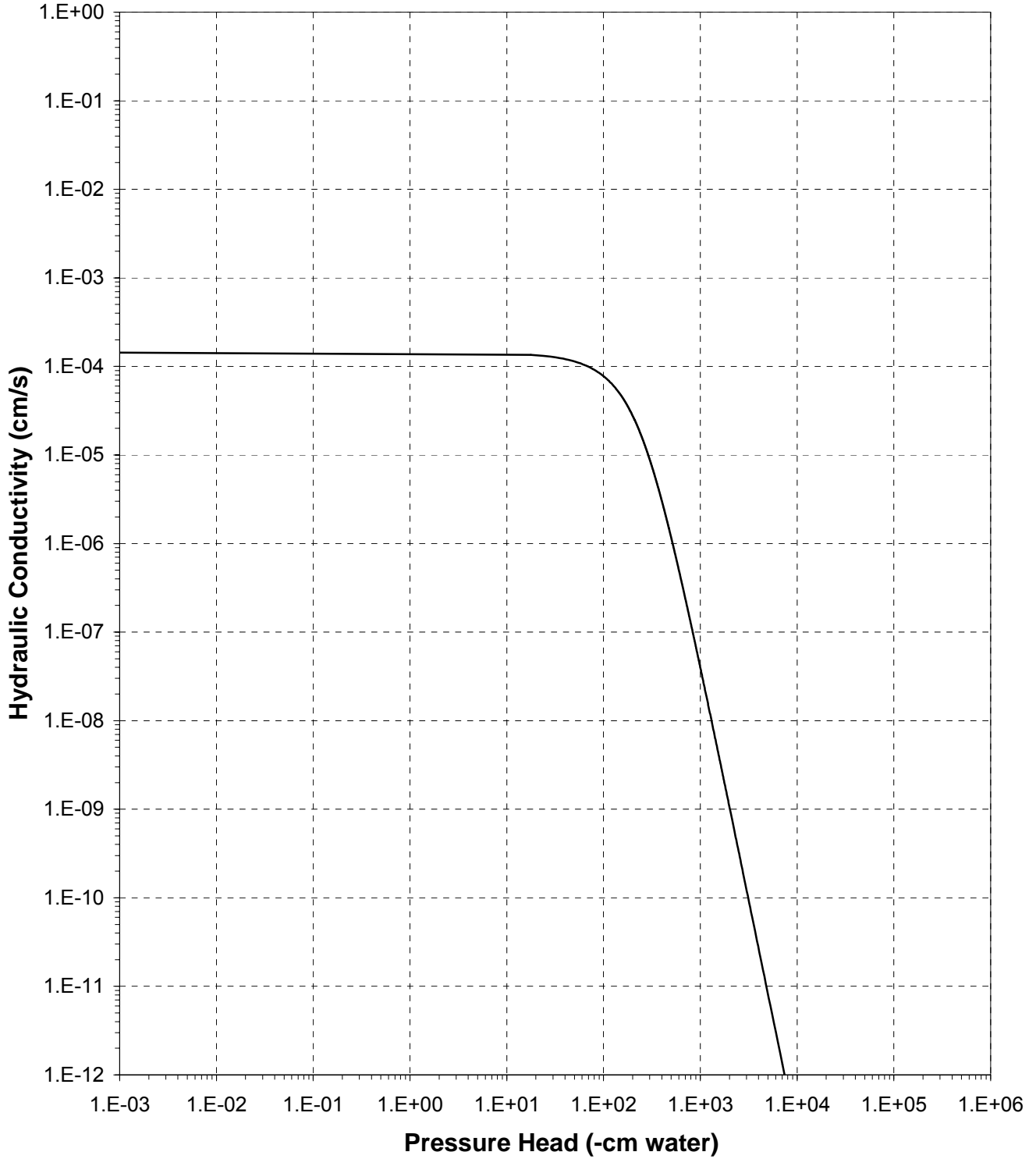





**Moisture Retention Data**  
**Hanging Column / Pressure Plate**  
 (Soil-Water Characteristic Curve)

Job Name: Barr Engineering Company  
 Job Number: LB10.0170.00  
 Sample Number: Blend 1 (55%)  
 Ring Number: NA  
 Depth: NA

Dry wt. of sample (g): 185.91  
 Tare wt., ring (g): 85.21  
 Tare wt., screen & clamp (g): 27.76  
 Initial sample volume (cm<sup>3</sup>): 140.40  
 Initial dry bulk density (g/cm<sup>3</sup>): 1.32  
 Measured particle density (g/cm<sup>3</sup>): 2.99  
 Initial calculated total porosity (%): 55.69

	Date	Time	Weight* (g)	Matric Potential (-cm water)	Moisture Content † (% vol)	
<i>Hanging column:</i>	7-Sep-10	10:50	354.83	0	48.03	##
	13-Sep-10	10:25	341.64	12.0	40.83	##
	19-Sep-10	10:30	338.56	31.0	38.62	##
	26-Sep-10	8:55	336.23	101.0	37.36	##
<i>Pressure plate:</i>	4-Oct-10	12:30	332.45	337	33.67	##

Volume Adjusted Data <sup>1</sup>

	Matric Potential (-cm water)	Adjusted Volume (cm <sup>3</sup> )	% Volume Change <sup>2</sup> (%)	Adjusted Density (g/cm <sup>3</sup> )	Adjusted Calculated Porosity (%)
<i>Hanging column:</i>	0.0	116.48	-17.03%	1.60	46.60
	12.0	104.74	-25.40%	1.78	40.61
	31.0	102.75	-26.82%	1.81	39.46
	101.0	99.98	-28.79%	1.86	37.78
<i>Pressure plate:</i>	337	99.70	-28.99%	1.86	37.60

**Comments:**

<sup>1</sup> Applicable if the sample experienced volume changes during testing. 'Volume Adjusted' values represent each of the volume change measurements obtained after saturated hydraulic conductivity testing and throughout hanging column/pressure plate testing. "---" indicates no volume changes occurred.

<sup>2</sup> Represents percent volume change from original sample volume. A '+' denotes measured sample swelling, a '-' denotes measured sample settling, and '---' denotes no volume change occurred.

\* Weight including tares

† Assumed density of water is 1.0 g/cm<sup>3</sup>

## Volume adjustments are applicable at this matric potential (see comment #1).

**Technician Notes:**

*Laboratory analysis by:* K. Wright  
*Data entered by:* K. Wright  
*Checked by:* J. Hines



**Moisture Retention Data**  
**Dew Point Potentiometer / Relative Humidity Box**  
 (Soil-Water Characteristic Curve)

Sample Number: Blend 1 (55%)

Initial sample bulk density (g/cm<sup>3</sup>): 1.32  
 Fraction of bulk sample used (<2.00mm fraction) (%): 100.00

Dry weight\* of dew point potentiometer sample (g): 146.36  
 Tare weight, jar (g): 114.27

	Date	Time	Weight* (g)	Water Potential (-cm water)	Moisture Content <sup>†</sup> (% vol)	
Dew point potentiometer:	23-Sep-10	14:49	147.09	17745	4.24	##
	23-Sep-10	14:21	146.80	44769	2.56	##
	23-Sep-10	14:08	146.69	109323	1.92	##

Volume Adjusted Data<sup>1</sup>

	Water Potential (-cm water)	Adjusted Volume (cm <sup>3</sup> )	% Volume Change <sup>2</sup> (%)	Adjusted Density (g/cm <sup>3</sup> )	Adjusted Calc. Porosity (%)
Dew point potentiometer:	17745	99.70	-28.99%	1.86	37.60
	44769	99.70	-28.99%	1.86	37.60
	109323	99.70	-28.99%	1.86	37.60

Dry weight\* of relative humidity box sample (g): 71.35  
 Tare weight (g): 40.00

	Date	Time	Weight* (g)	Water Potential (-cm water)	Moisture Content <sup>†</sup> (% vol)	
Relative humidity box:	16-Sep-10	10:45	71.47	861325	0.73	##

Volume Adjusted Data<sup>1</sup>

	Water Potential (-cm water)	Adjusted Volume (cm <sup>3</sup> )	% Volume Change <sup>2</sup> (%)	Adjusted Density (g/cm <sup>3</sup> )	Adjusted Calc. Porosity (%)
Relative humidity box:	861325	99.70	-28.99%	1.86	37.60

**Comments:**

<sup>1</sup> Applicable if the sample experienced volume changes during testing. 'Volume Adjusted' values represent the volume change measurements obtained after the last hanging column or pressure plate point. "----" indicates no volume changes occurred.

<sup>2</sup> Represents percent volume change from original sample volume. A '+' denotes measured sample swelling, a '-' denotes measured sample settling, and '---' denotes no volume change occurred.

\* Weight including tares

<sup>†</sup> Adjusted for >2.00mm (#10 sieve) material not used in DPP/RH testing. Assumed moisture content of material >2.00mm is zero, and assumed density of water is 1.0 g/cm<sup>3</sup>.

## Volume adjustments are applicable at this matric potential (see comment #1).

Laboratory analysis by: M. Vigil  
 Data entered by: K. Wright  
 Checked by: J. Hines



### Water Retention Data Points

Sample Number: Blend 1 (55%)

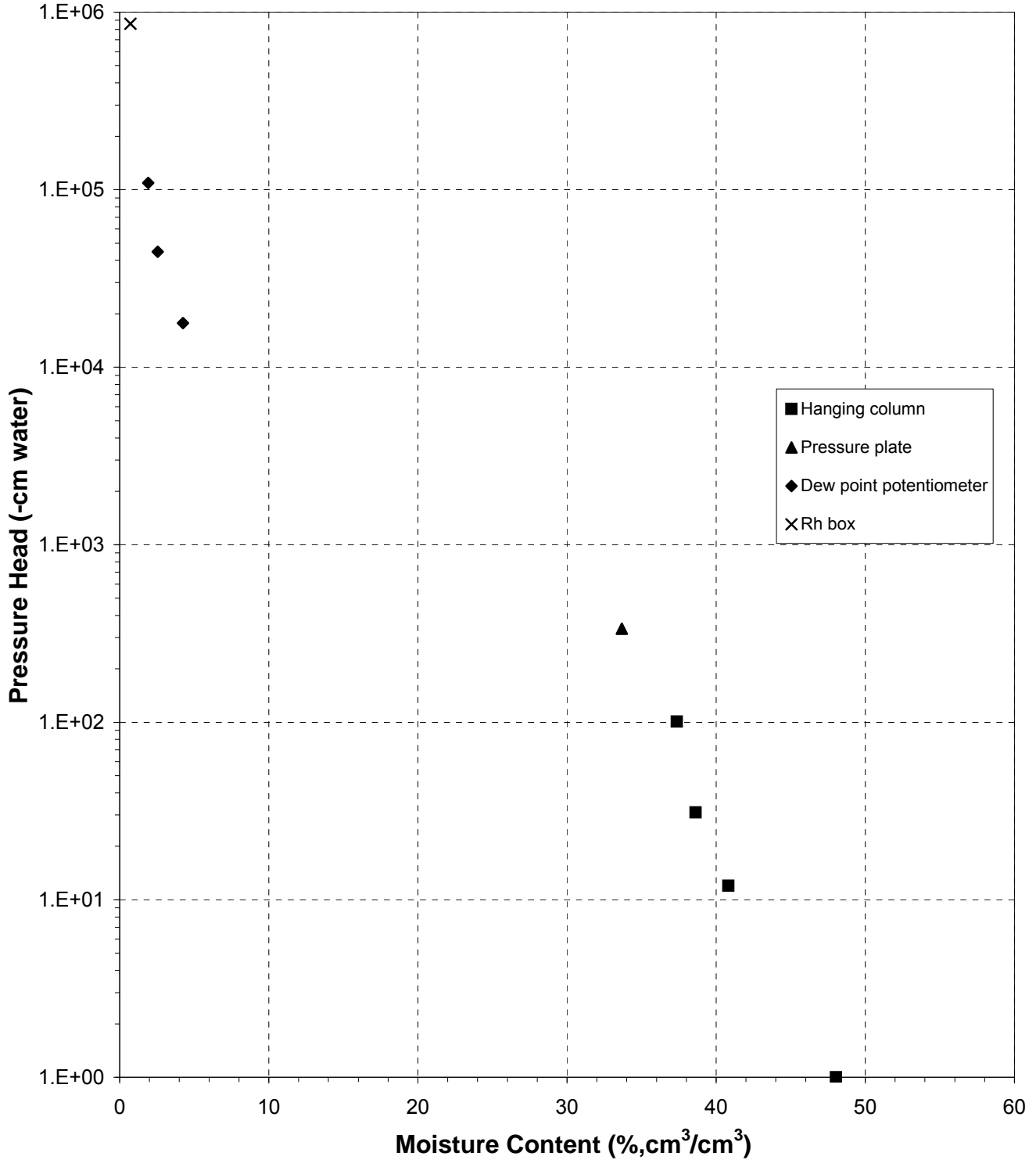



### Predicted Water Retention Curve and Data Points

Sample Number: Blend 1 (55%)

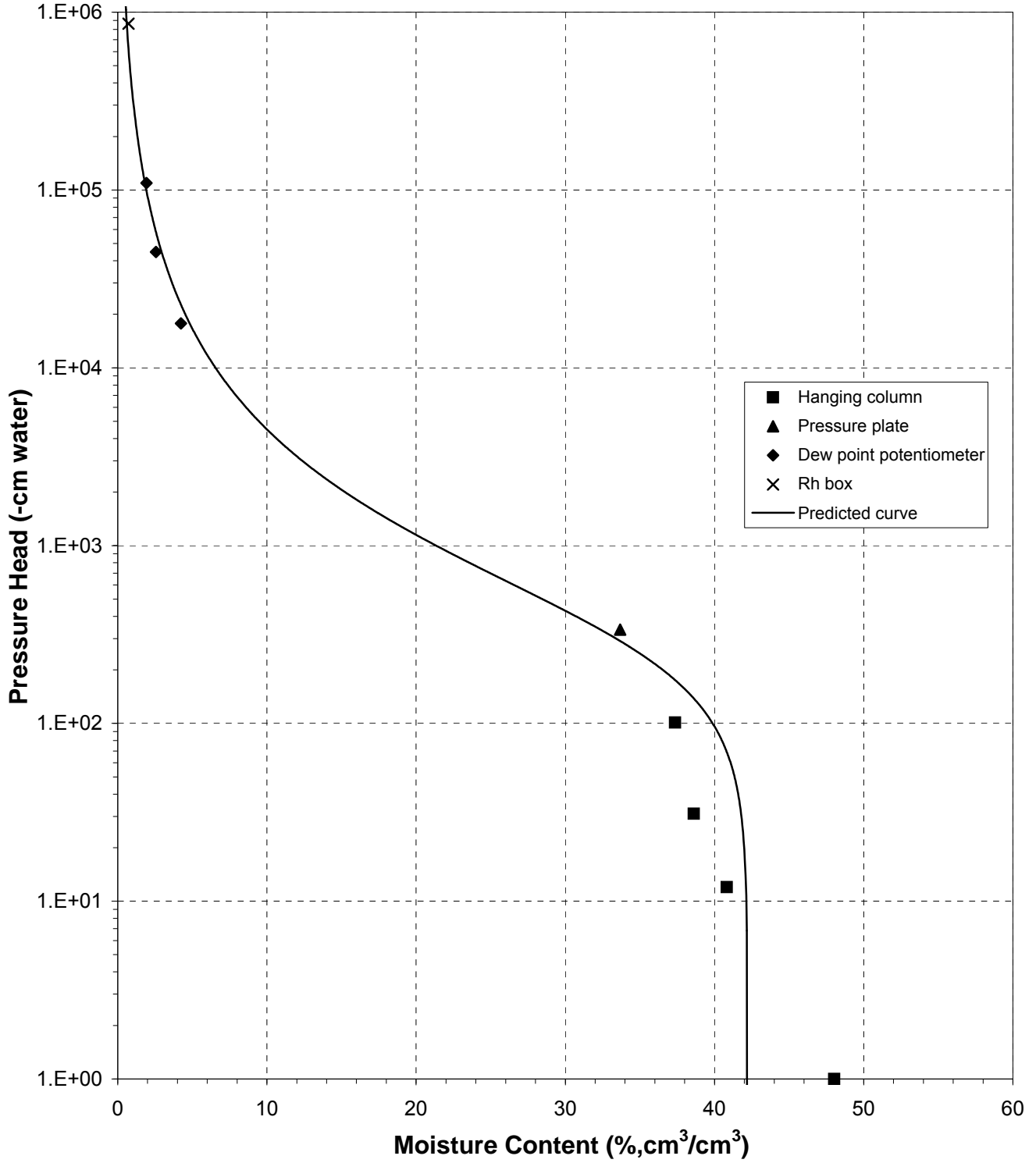



### Plot of Relative Hydraulic Conductivity vs Moisture Content

Sample Number: Blend 1 (55%)

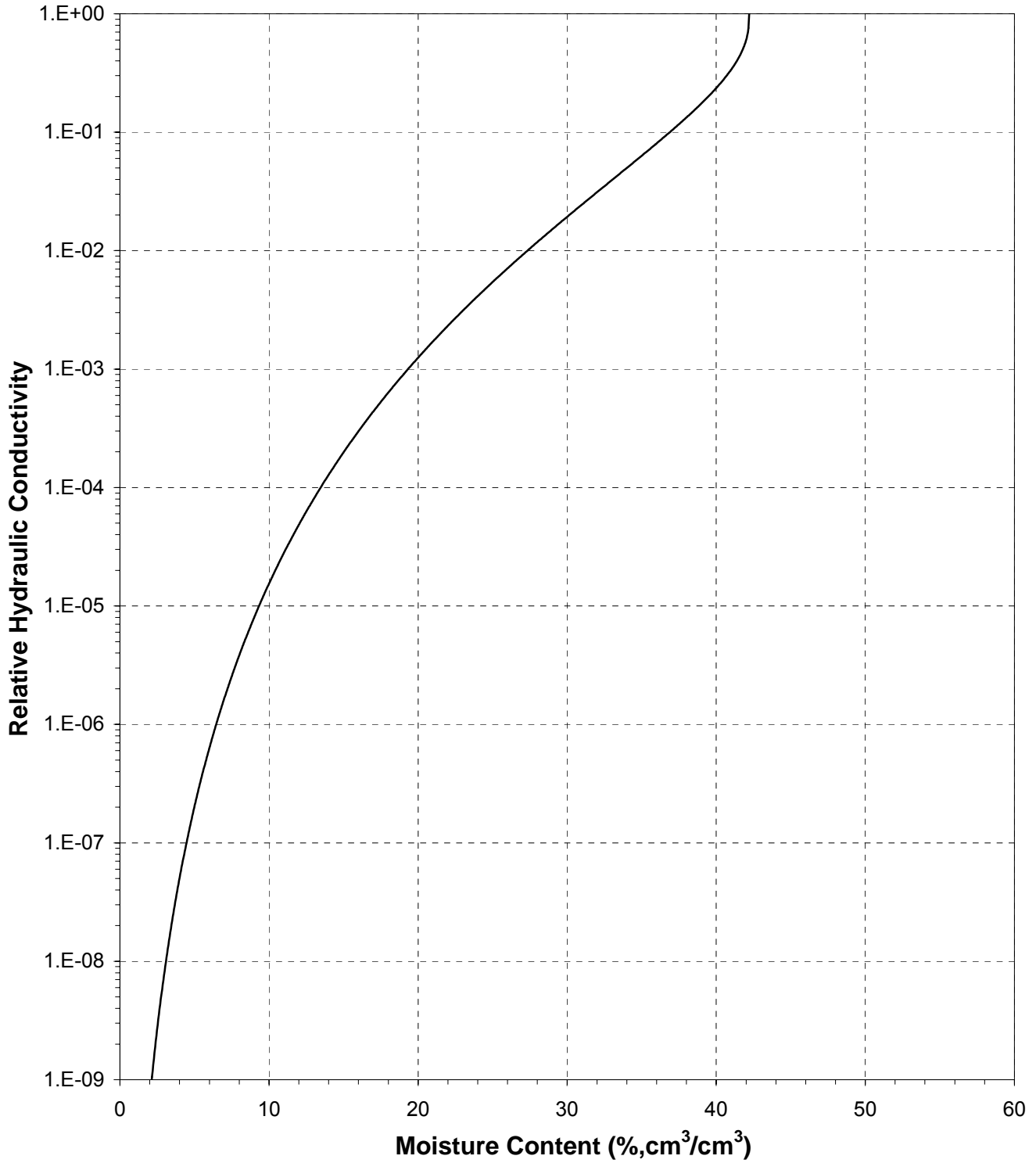



### Plot of Hydraulic Conductivity vs Moisture Content

Sample Number: Blend 1 (55%)

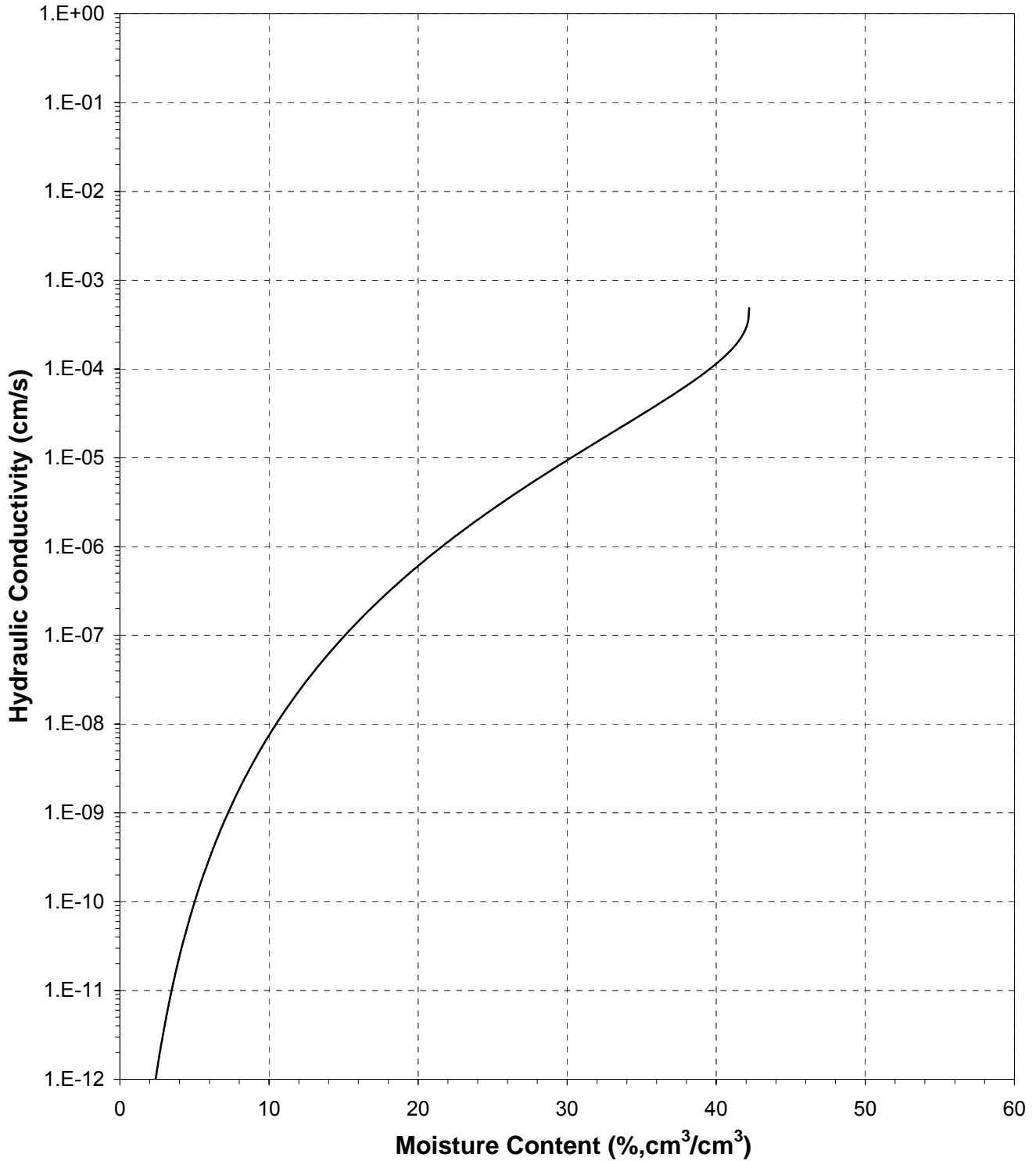



### Plot of Relative Hydraulic Conductivity vs Pressure Head

Sample Number: Blend 1 (55%)

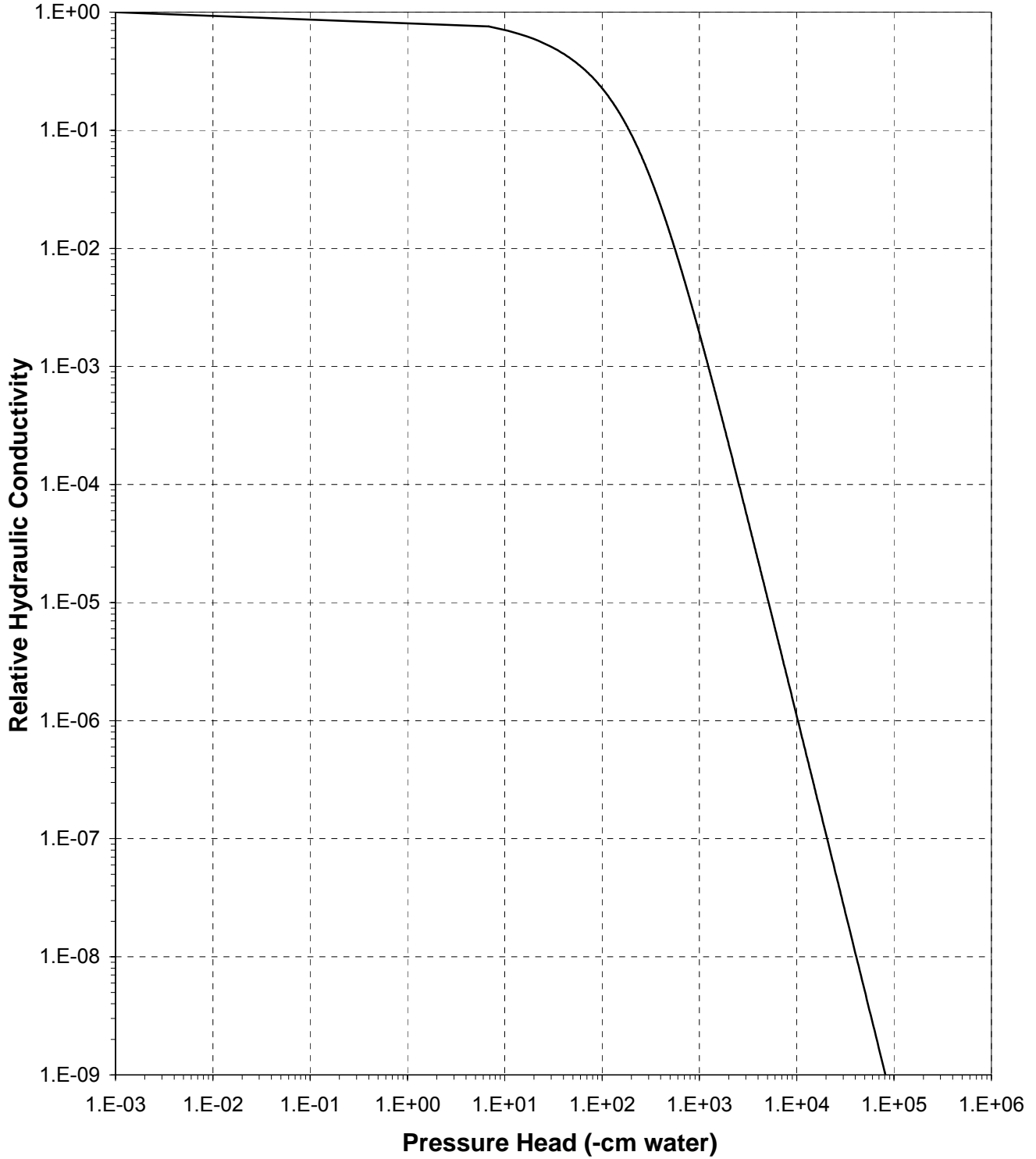



### Plot of Hydraulic Conductivity vs Pressure Head

Sample Number: Blend 1 (55%)

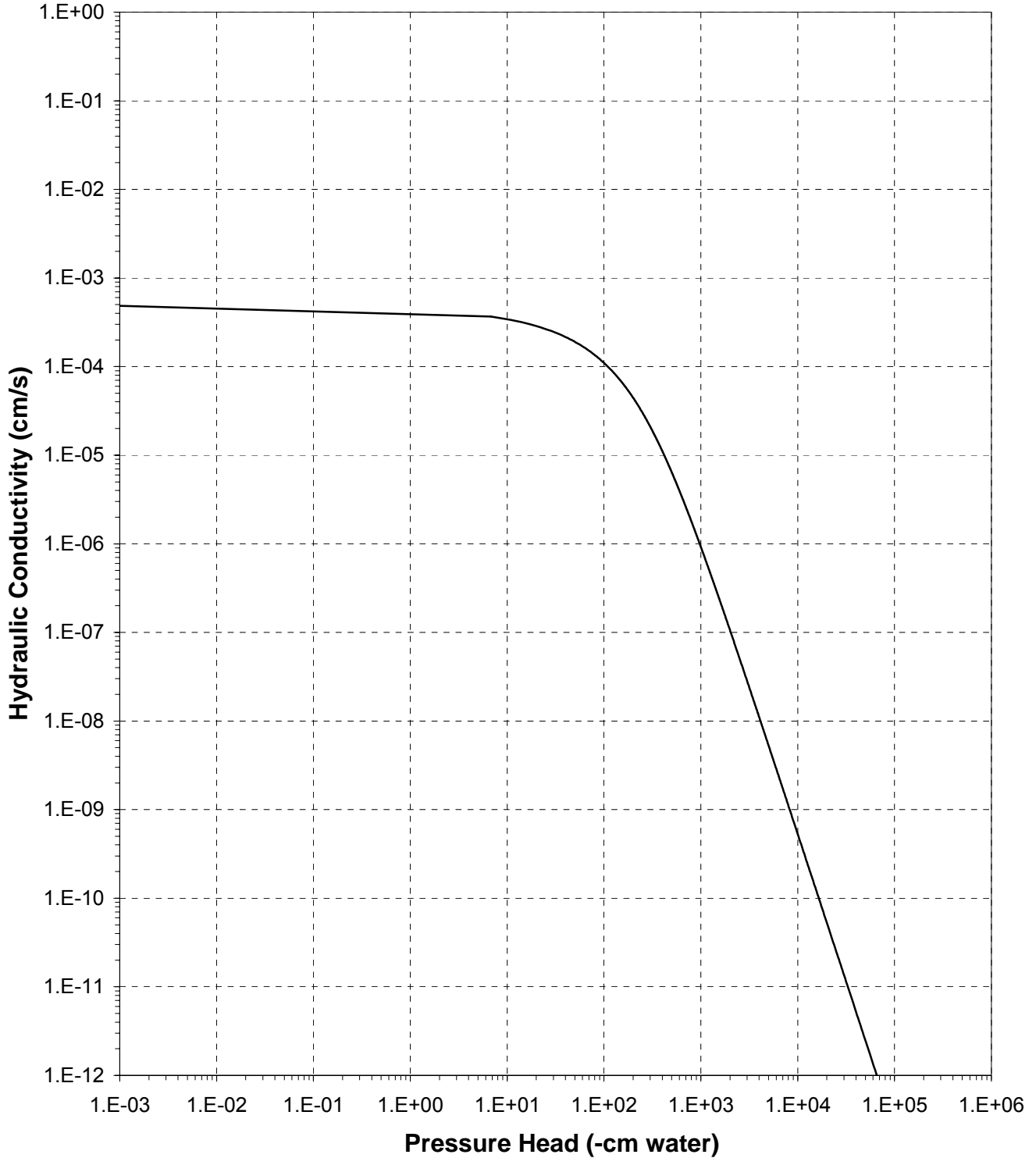





**Moisture Retention Data**  
**Hanging Column / Pressure Plate**  
 (Soil-Water Characteristic Curve)

Job Name: Barr Engineering Company  
 Job Number: LB10.0170.00  
 Sample Number: Blend 2 (39%)  
 Ring Number: NA  
 Depth: NA

Dry wt. of sample (g): 264.75  
 Tare wt., ring (g): 89.02  
 Tare wt., screen & clamp (g): 25.01  
 Initial sample volume (cm<sup>3</sup>): 147.03  
 Initial dry bulk density (g/cm<sup>3</sup>): 1.80  
 Measured particle density (g/cm<sup>3</sup>): 2.98  
 Initial calculated total porosity (%): 39.65

	Date	Time	Weight* (g)	Matric Potential (-cm water)	Moisture Content † (% vol)
<i>Hanging column:</i>	7-Sep-10	10:30	437.43	0	39.89
	13-Sep-10	10:20	435.52	12.0	38.59
	19-Sep-10	10:25	434.95	31.0	38.20
	26-Sep-10	8:50	434.51	101.0	37.90
<i>Pressure plate:</i>	4-Oct-10	12:40	403.57	337	16.86

Volume Adjusted Data<sup>1</sup>

	Matric Potential (-cm water)	Adjusted Volume (cm <sup>3</sup> )	% Volume Change <sup>2</sup> (%)	Adjusted Density (g/cm <sup>3</sup> )	Adjusted Calculated Porosity (%)
<i>Hanging column:</i>	0.0	---	---	---	---
	12.0	---	---	---	---
	31.0	---	---	---	---
	101.0	---	---	---	---
<i>Pressure plate:</i>	337	---	---	---	---

**Comments:**

<sup>1</sup> Applicable if the sample experienced volume changes during testing. 'Volume Adjusted' values represent each of the volume change measurements obtained after saturated hydraulic conductivity testing and throughout hanging column/pressure plate testing. "---" indicates no volume changes occurred.

<sup>2</sup> Represents percent volume change from original sample volume. A '+' denotes measured sample swelling, a '-' denotes measured sample settling, and '---' denotes no volume change occurred.

\* Weight including tares

† Assumed density of water is 1.0 g/cm<sup>3</sup>

‡ Volume adjustments are applicable at this matric potential (see comment #1).

**Technician Notes:**

*Laboratory analysis by:* K. Wright  
*Data entered by:* K. Wright  
*Checked by:* J. Hines



**Moisture Retention Data**  
**Dew Point Potentiometer / Relative Humidity Box**  
 (Soil-Water Characteristic Curve)

Sample Number: Blend 2 (39%)

Initial sample bulk density (g/cm<sup>3</sup>): 1.80  
 Fraction of bulk sample used (<2.00mm fraction) (%): 100.00

Dry weight\* of dew point potentiometer sample (g): 151.18  
 Tare weight, jar (g): 118.41

	Date	Time	Weight* (g)	Water Potential (-cm water)	Moisture Content <sup>†</sup> (% vol)
Dew point potentiometer:	24-Sep-10	10:15	151.64	16419	2.53
	24-Sep-10	9:57	151.51	35489	1.81
	23-Sep-10	9:32	151.41	142772	1.26

Volume Adjusted Data<sup>1</sup>

	Water Potential (-cm water)	Adjusted Volume (cm <sup>3</sup> )	% Volume Change <sup>2</sup> (%)	Adjusted Density (g/cm <sup>3</sup> )	Adjusted Calc. Porosity (%)
Dew point potentiometer:	16419	---	---	---	---
	35489	---	---	---	---
	142772	---	---	---	---

Dry weight\* of relative humidity box sample (g): 74.86  
 Tare weight (g): 41.72

	Date	Time	Weight* (g)	Water Potential (-cm water)	Moisture Content <sup>†</sup> (% vol)
Relative humidity box:	16-Sep-10	10:45	74.97	861325	0.59

Volume Adjusted Data<sup>1</sup>

	Water Potential (-cm water)	Adjusted Volume (cm <sup>3</sup> )	% Volume Change <sup>2</sup> (%)	Adjusted Density (g/cm <sup>3</sup> )	Adjusted Calc. Porosity (%)
Relative humidity box:	861325	---	---	---	---

**Comments:**

<sup>1</sup> Applicable if the sample experienced volume changes during testing. 'Volume Adjusted' values represent the volume change measurements obtained after the last hanging column or pressure plate point. "----" indicates no volume changes occurred.

<sup>2</sup> Represents percent volume change from original sample volume. A '+' denotes measured sample swelling, a '-' denotes measured sample settling, and '---' denotes no volume change occurred.

\* Weight including tares

<sup>†</sup> Adjusted for >2.00mm (#10 sieve) material not used in DPP/RH testing. Assumed moisture content of material >2.00mm is zero, and assumed density of water is 1.0 g/cm<sup>3</sup>.

<sup>##</sup> Volume adjustments are applicable at this matric potential (see comment #1).

Laboratory analysis by: M. Vigil  
 Data entered by: K. Wright  
 Checked by: J. Hines



### Water Retention Data Points

Sample Number: Blend 2 (39%)

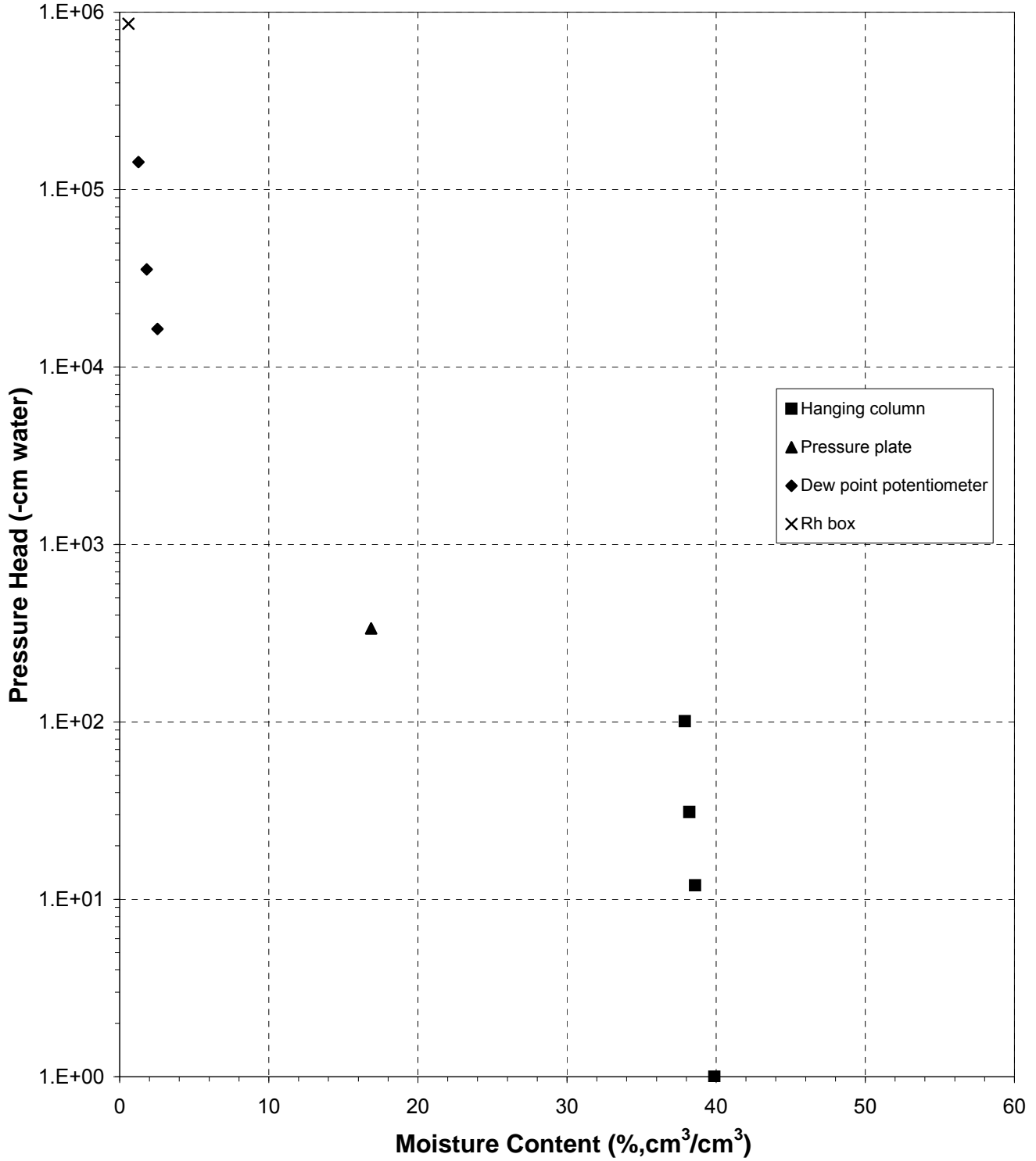



### Predicted Water Retention Curve and Data Points

Sample Number: Blend 2 (39%)

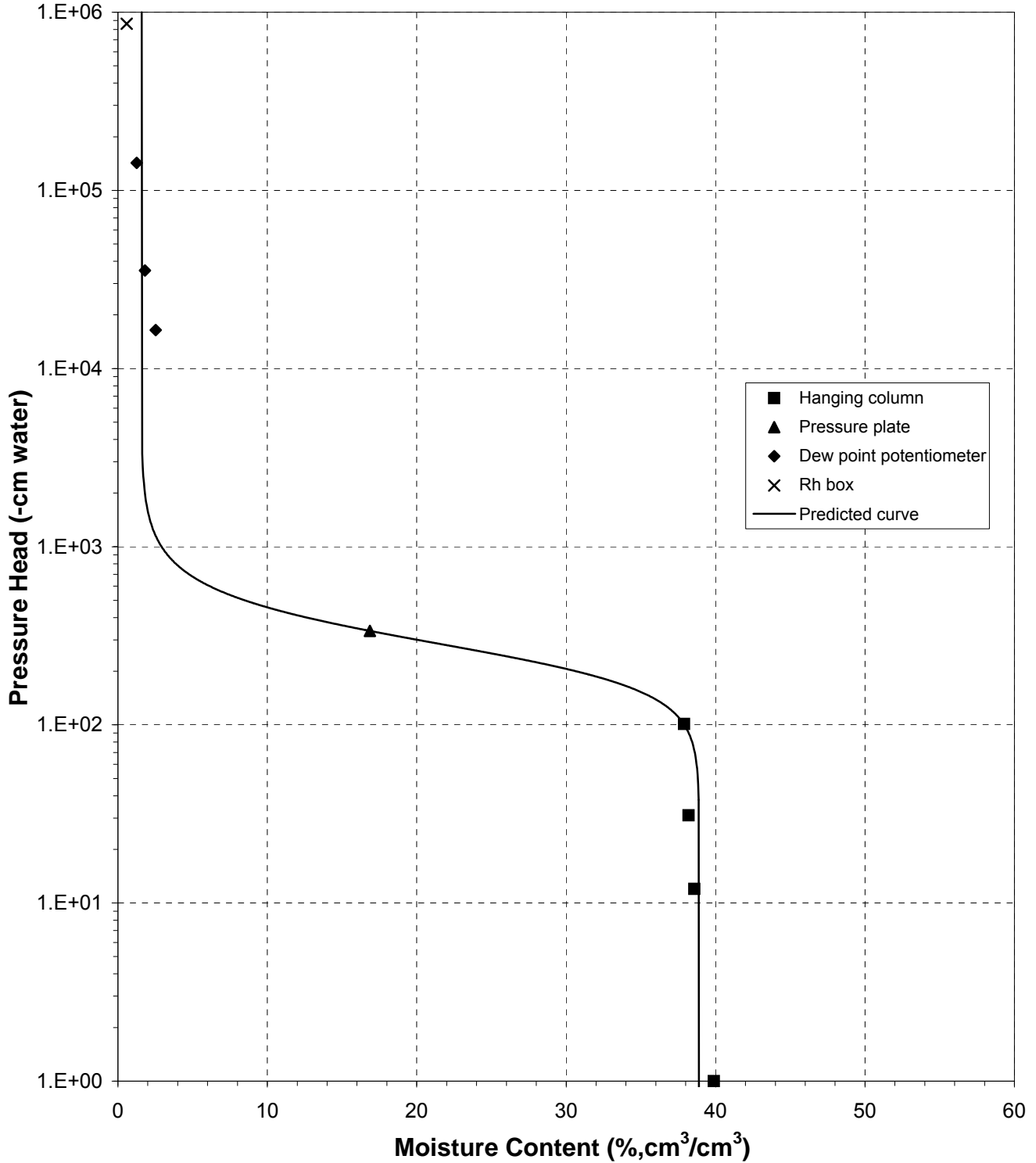



### Plot of Relative Hydraulic Conductivity vs Moisture Content

Sample Number: Blend 2 (39%)

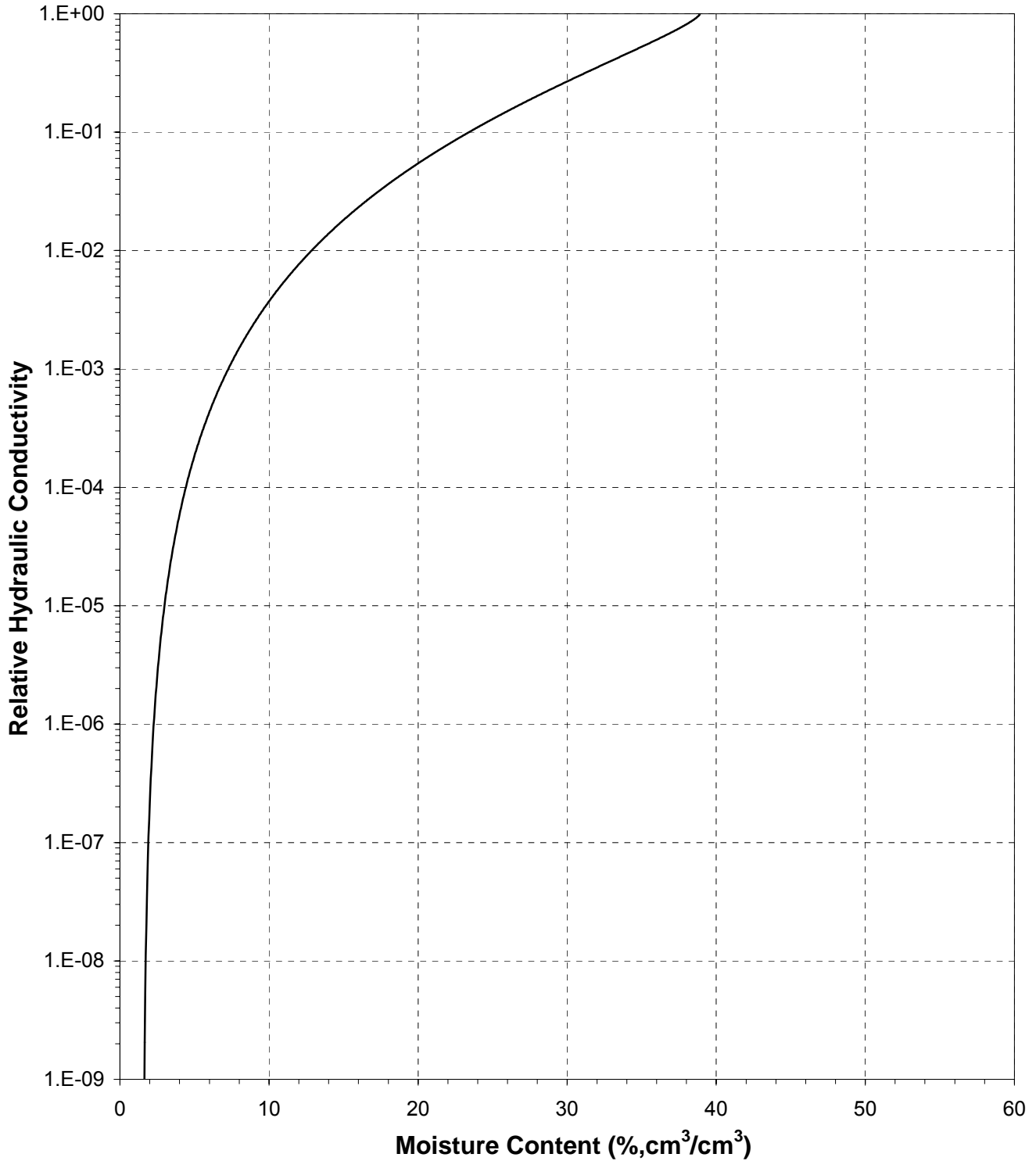



### Plot of Hydraulic Conductivity vs Moisture Content

Sample Number: Blend 2 (39%)

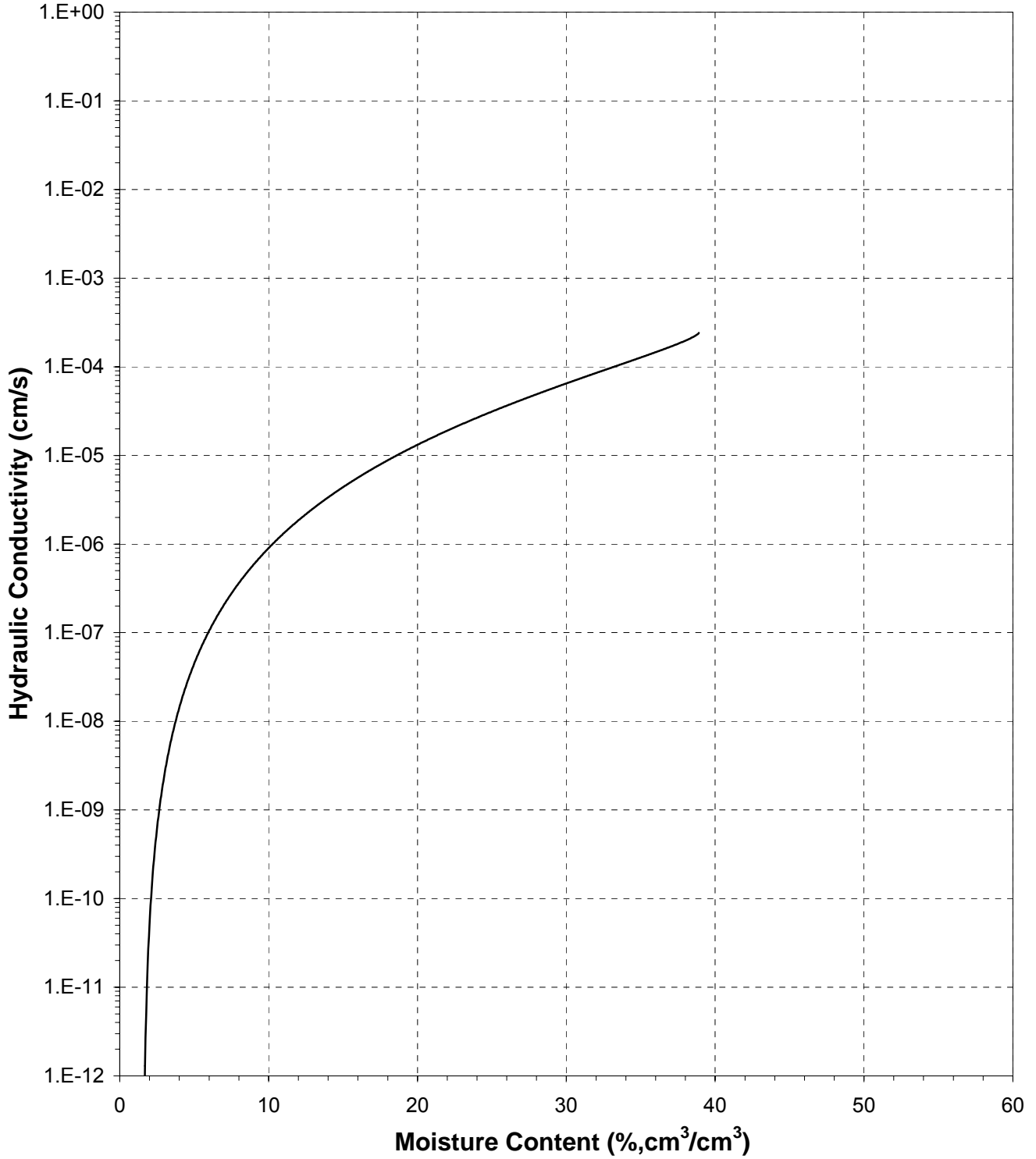



### Plot of Relative Hydraulic Conductivity vs Pressure Head

Sample Number: Blend 2 (39%)

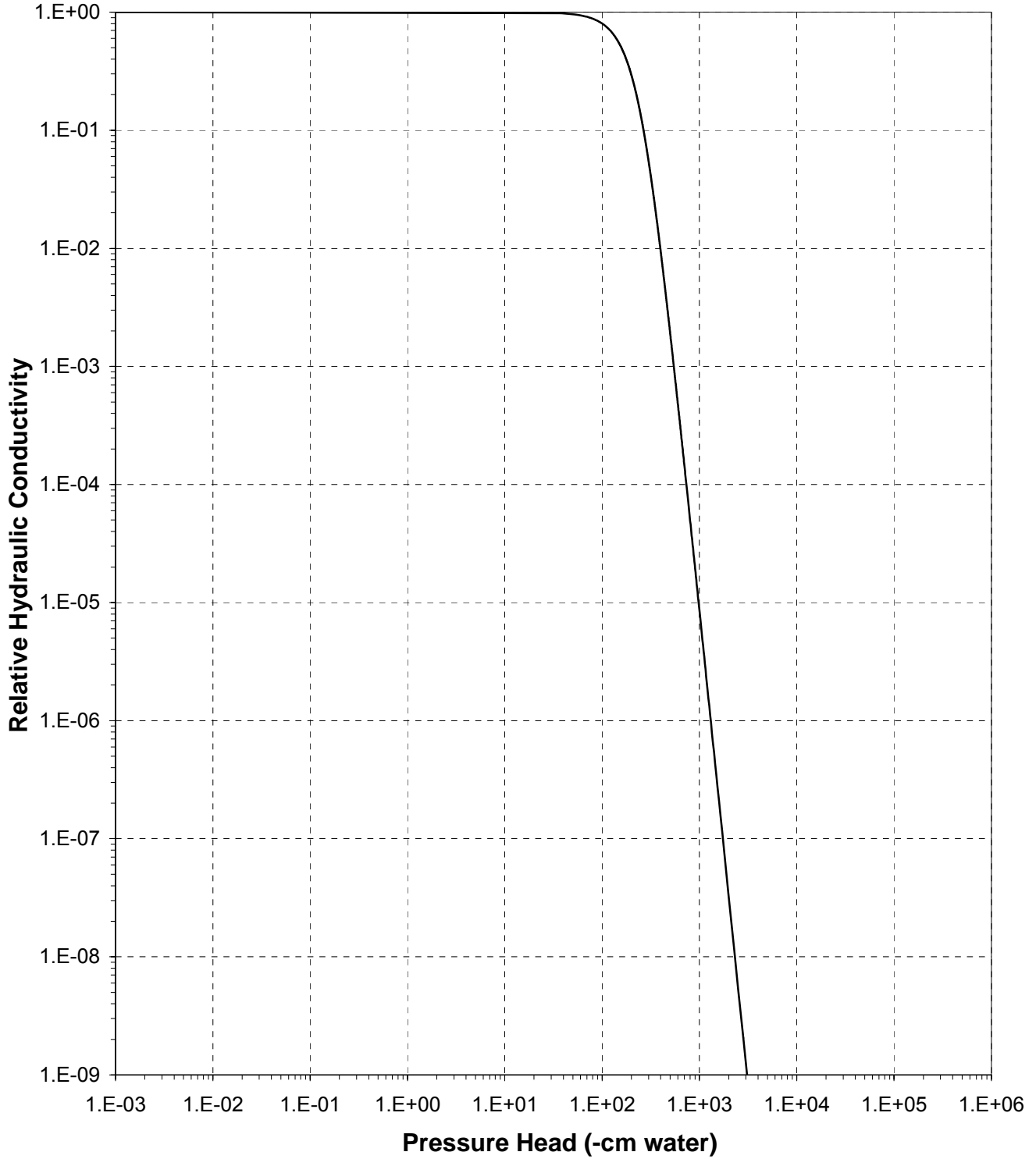



### Plot of Hydraulic Conductivity vs Pressure Head

Sample Number: Blend 2 (39%)

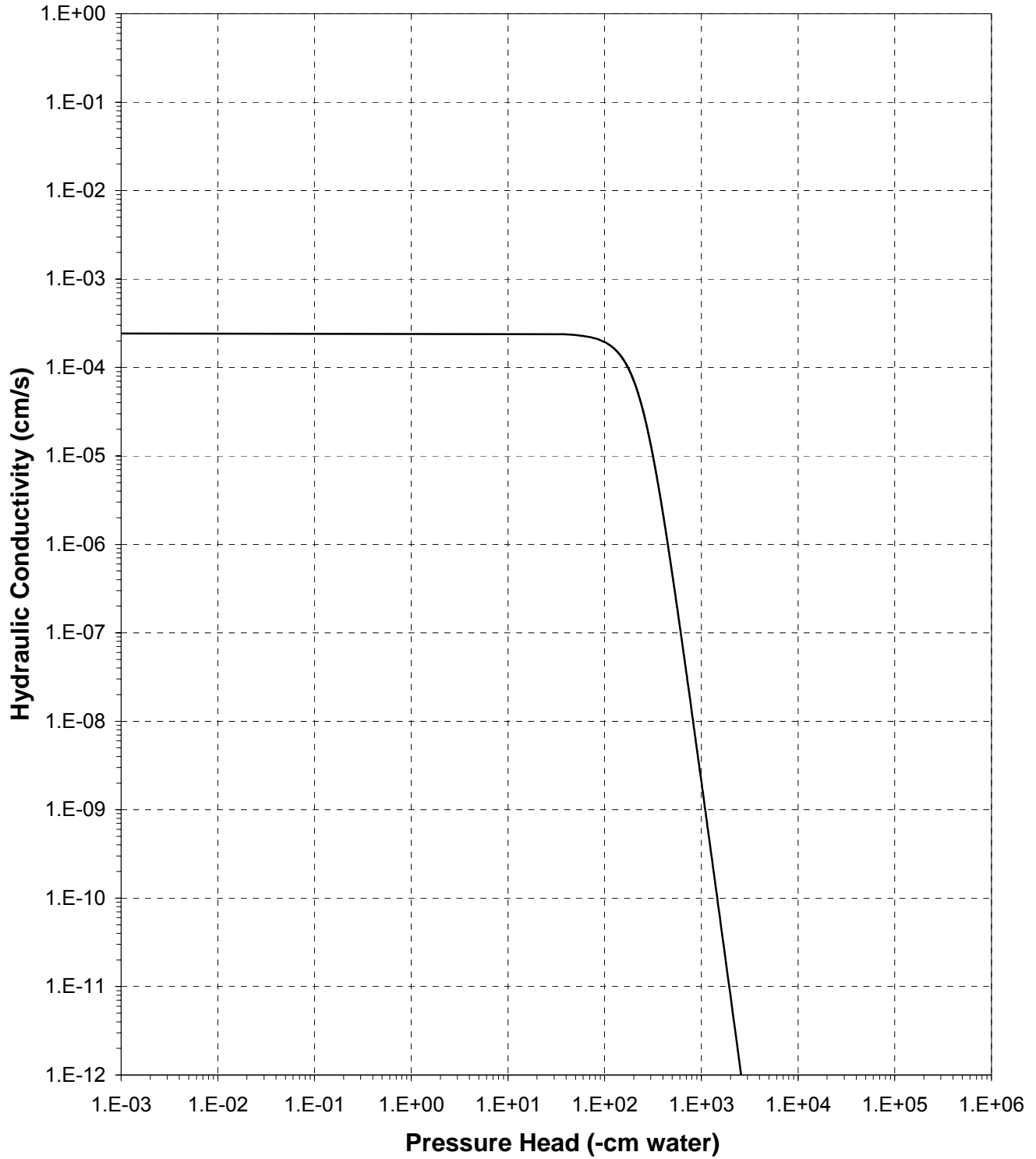





**Moisture Retention Data**  
**Hanging Column / Pressure Plate**  
 (Soil-Water Characteristic Curve)

Job Name: Barr Engineering Company  
 Job Number: LB10.0170.00  
 Sample Number: Blend 2 (45%)  
 Ring Number: NA  
 Depth: NA

Dry wt. of sample (g): 228.69  
 Tare wt., ring (g): 110.15  
 Tare wt., screen & clamp (g): 25.25  
 Initial sample volume (cm<sup>3</sup>): 139.97  
 Initial dry bulk density (g/cm<sup>3</sup>): 1.63  
 Measured particle density (g/cm<sup>3</sup>): 2.98  
 Initial calculated total porosity (%): 45.24

	Date	Time	Weight* (g)	Matric Potential (-cm water)	Moisture Content † (% vol)	
<i>Hanging column:</i>	7-Sep-10	10:25	426.02	0	45.78	##
	13-Sep-10	10:20	420.90	12.0	43.48	##
	19-Sep-10	10:20	418.04	31.0	41.70	##
	26-Sep-10	8:45	415.34	101.0	40.15	##
<i>Pressure plate:</i>	4-Oct-10	12:35	388.83	337	19.41	##

Volume Adjusted Data<sup>1</sup>

	Matric Potential (-cm water)	Adjusted Volume (cm <sup>3</sup> )	% Volume Change <sup>2</sup> (%)	Adjusted Density (g/cm <sup>3</sup> )	Adjusted Calculated Porosity (%)
<i>Hanging column:</i>	0.0	135.26	-3.36%	1.69	43.33
	12.0	130.65	-6.66%	1.75	41.33
	31.0	129.36	-7.58%	1.77	40.75
	101.0	127.64	-8.81%	1.79	39.95
<i>Pressure plate:</i>	337	127.49	-8.91%	1.79	39.88

**Comments:**

<sup>1</sup> Applicable if the sample experienced volume changes during testing. 'Volume Adjusted' values represent each of the volume change measurements obtained after saturated hydraulic conductivity testing and throughout hanging column/pressure plate testing. "---" indicates no volume changes occurred.

<sup>2</sup> Represents percent volume change from original sample volume. A '+' denotes measured sample swelling, a '-' denotes measured sample settling, and '---' denotes no volume change occurred.

\* Weight including tares

† Assumed density of water is 1.0 g/cm<sup>3</sup>

## Volume adjustments are applicable at this matric potential (see comment #1).

**Technician Notes:**

*Laboratory analysis by:* K. Wright  
*Data entered by:* K. Wright  
*Checked by:* J. Hines



**Moisture Retention Data**  
**Dew Point Potentiometer / Relative Humidity Box**  
 (Soil-Water Characteristic Curve)

Sample Number: Blend 2 (45%)

Initial sample bulk density (g/cm<sup>3</sup>): 1.63  
 Fraction of bulk sample used (<2.00mm fraction) (%): 100.00

Dry weight\* of dew point potentiometer sample (g): 152.65  
 Tare weight, jar (g): 114.03

	Date	Time	Weight* (g)	Water Potential (-cm water)	Moisture Content <sup>†</sup> (% vol)	
Dew point potentiometer:	23-Sep-10	14:43	153.20	14583	2.55	##
	23-Sep-10	14:27	152.97	35489	1.49	##
	23-Sep-10	13:59	152.87	126455	1.02	##

Volume Adjusted Data<sup>1</sup>

	Water Potential (-cm water)	Adjusted Volume (cm <sup>3</sup> )	% Volume Change <sup>2</sup> (%)	Adjusted Density (g/cm <sup>3</sup> )	Adjusted Calc. Porosity (%)
Dew point potentiometer:	14583	127.49	-8.91%	1.79	39.88
	35489	127.49	-8.91%	1.79	39.88
	126455	127.49	-8.91%	1.79	39.88

Dry weight\* of relative humidity box sample (g): 76.30  
 Tare weight (g): 40.79

	Date	Time	Weight* (g)	Water Potential (-cm water)	Moisture Content <sup>†</sup> (% vol)	
Relative humidity box:	16-Sep-10	10:45	76.42	861325	0.59	##

Volume Adjusted Data<sup>1</sup>

	Water Potential (-cm water)	Adjusted Volume (cm <sup>3</sup> )	% Volume Change <sup>2</sup> (%)	Adjusted Density (g/cm <sup>3</sup> )	Adjusted Calc. Porosity (%)
Relative humidity box:	861325	127.49	-8.91%	1.79	39.88

**Comments:**

<sup>1</sup> Applicable if the sample experienced volume changes during testing. 'Volume Adjusted' values represent the volume change measurements obtained after the last hanging column or pressure plate point. "----" indicates no volume changes occurred.

<sup>2</sup> Represents percent volume change from original sample volume. A '+' denotes measured sample swelling, a '-' denotes measured sample settling, and '---' denotes no volume change occurred.

\* Weight including tares

<sup>†</sup> Adjusted for >2.00mm (#10 sieve) material not used in DPP/RH testing. Assumed moisture content of material >2.00mm is zero, and assumed density of water is 1.0 g/cm<sup>3</sup>.

## Volume adjustments are applicable at this matric potential (see comment #1).

Laboratory analysis by: M. Vigil  
 Data entered by: K. Wright  
 Checked by: J. Hines



### Water Retention Data Points

Sample Number: Blend 2 (45%)

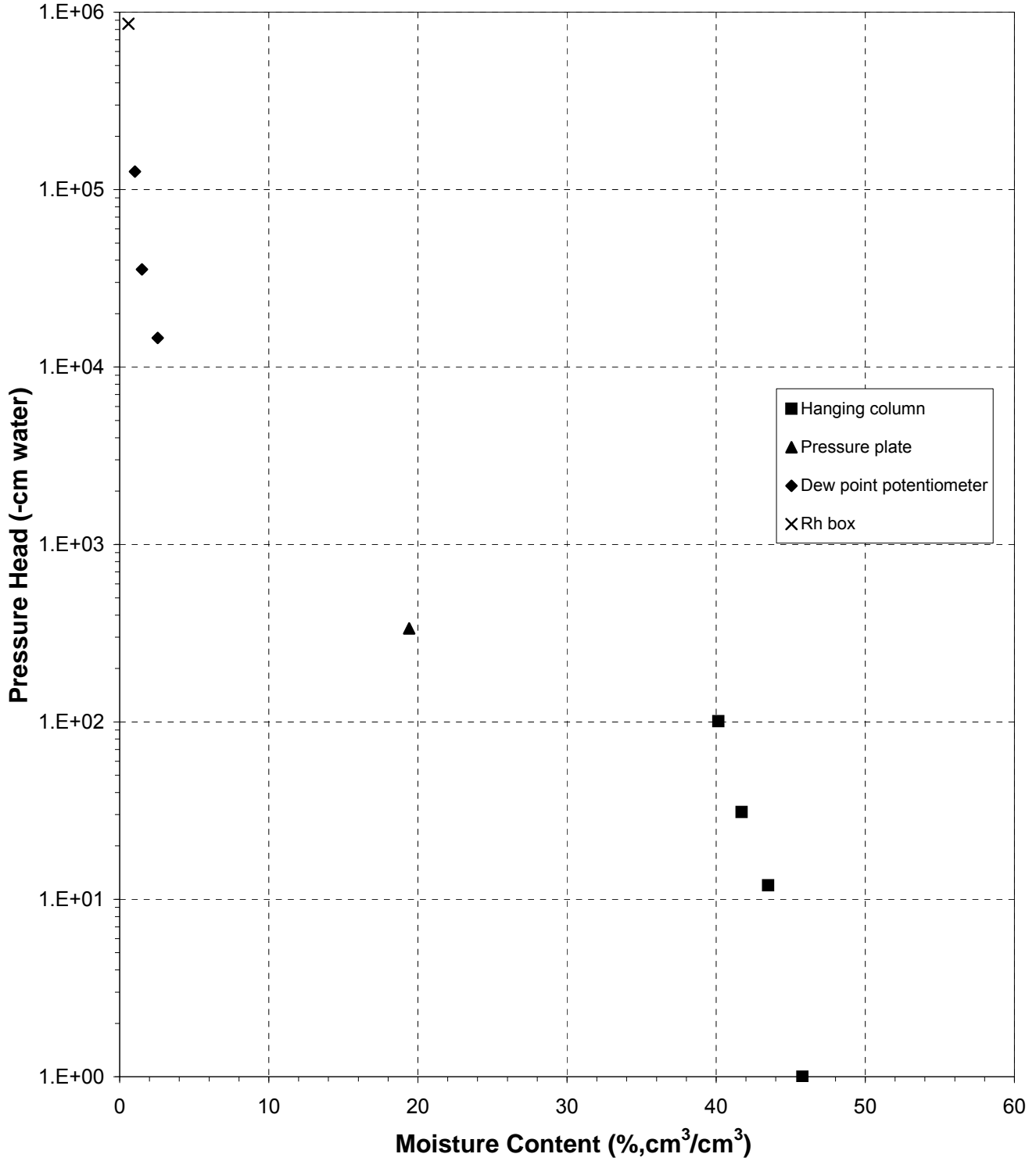



### Predicted Water Retention Curve and Data Points

Sample Number: Blend 2 (45%)

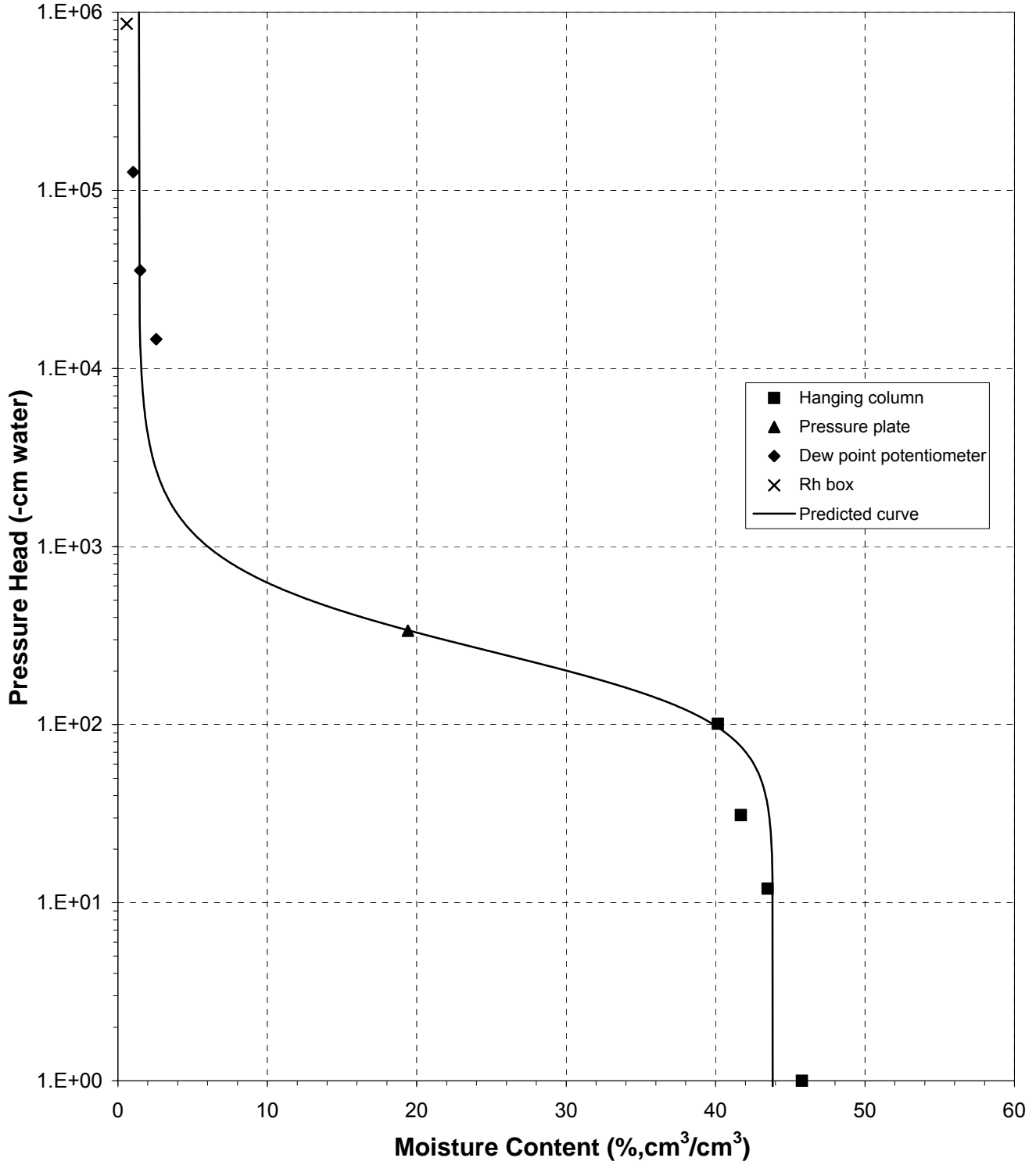



### Plot of Relative Hydraulic Conductivity vs Moisture Content

Sample Number: Blend 2 (45%)

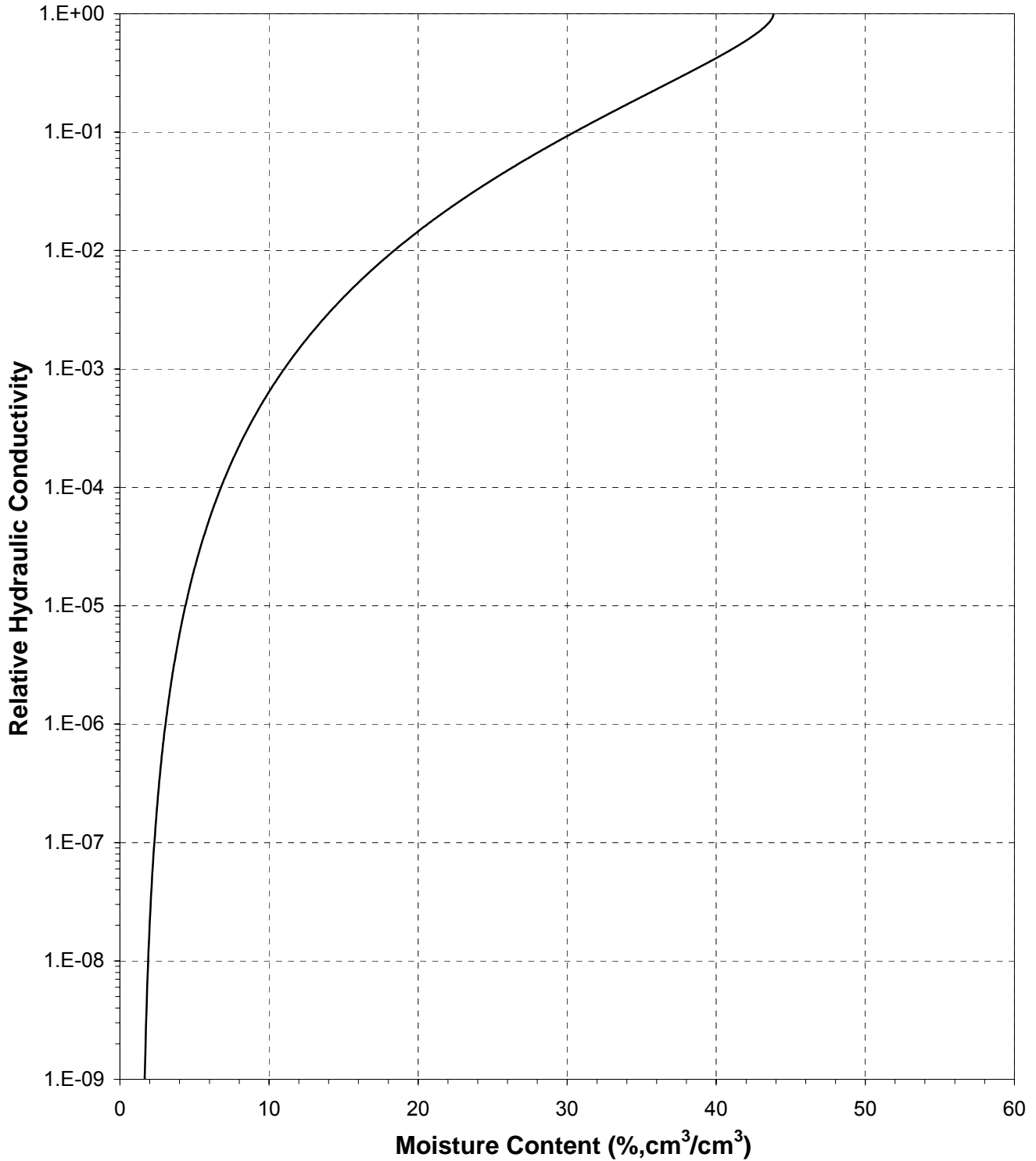



### Plot of Hydraulic Conductivity vs Moisture Content

Sample Number: Blend 2 (45%)

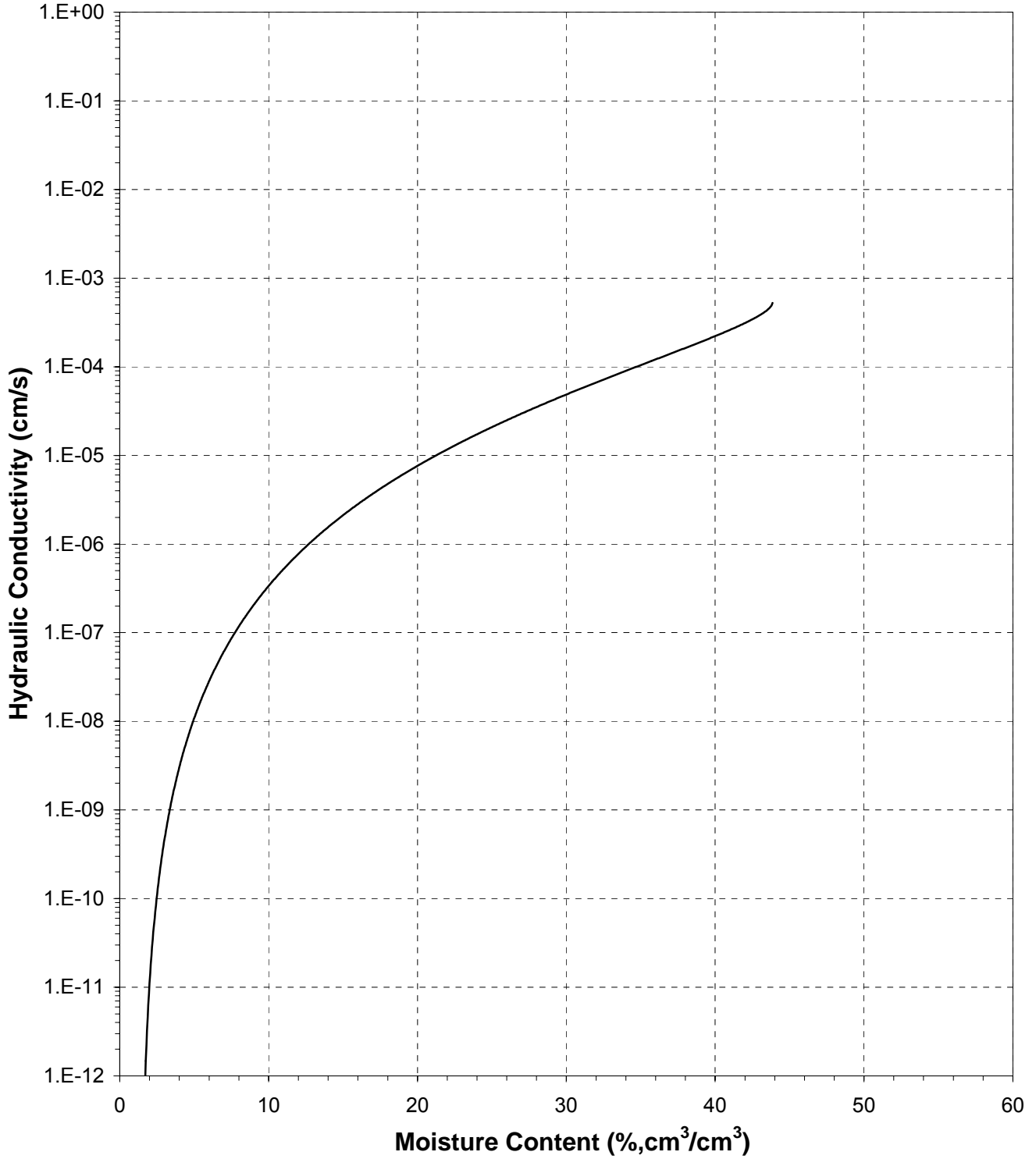



### Plot of Relative Hydraulic Conductivity vs Pressure Head

Sample Number: Blend 2 (45%)

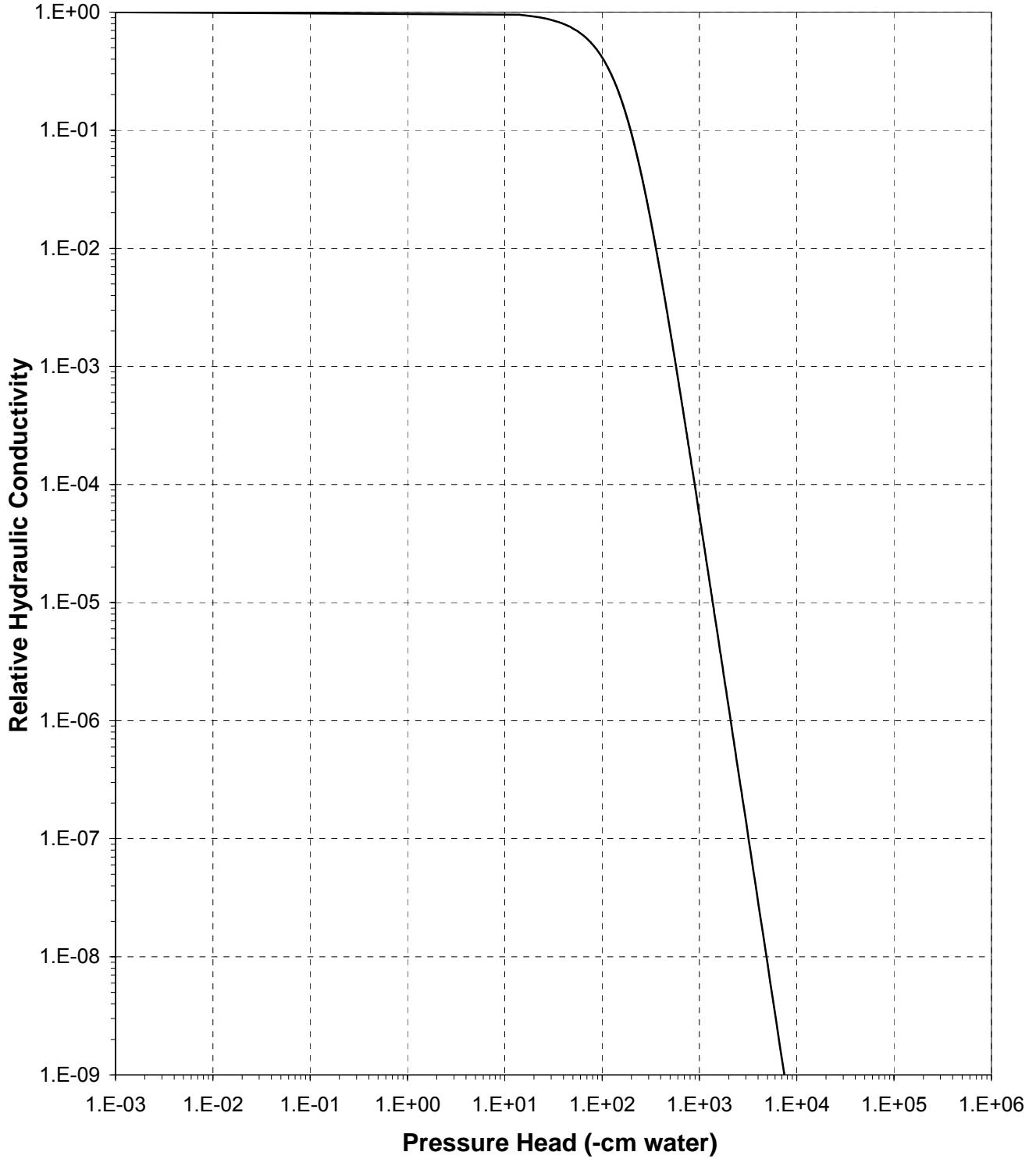



### Plot of Hydraulic Conductivity vs Pressure Head

Sample Number: Blend 2 (45%)

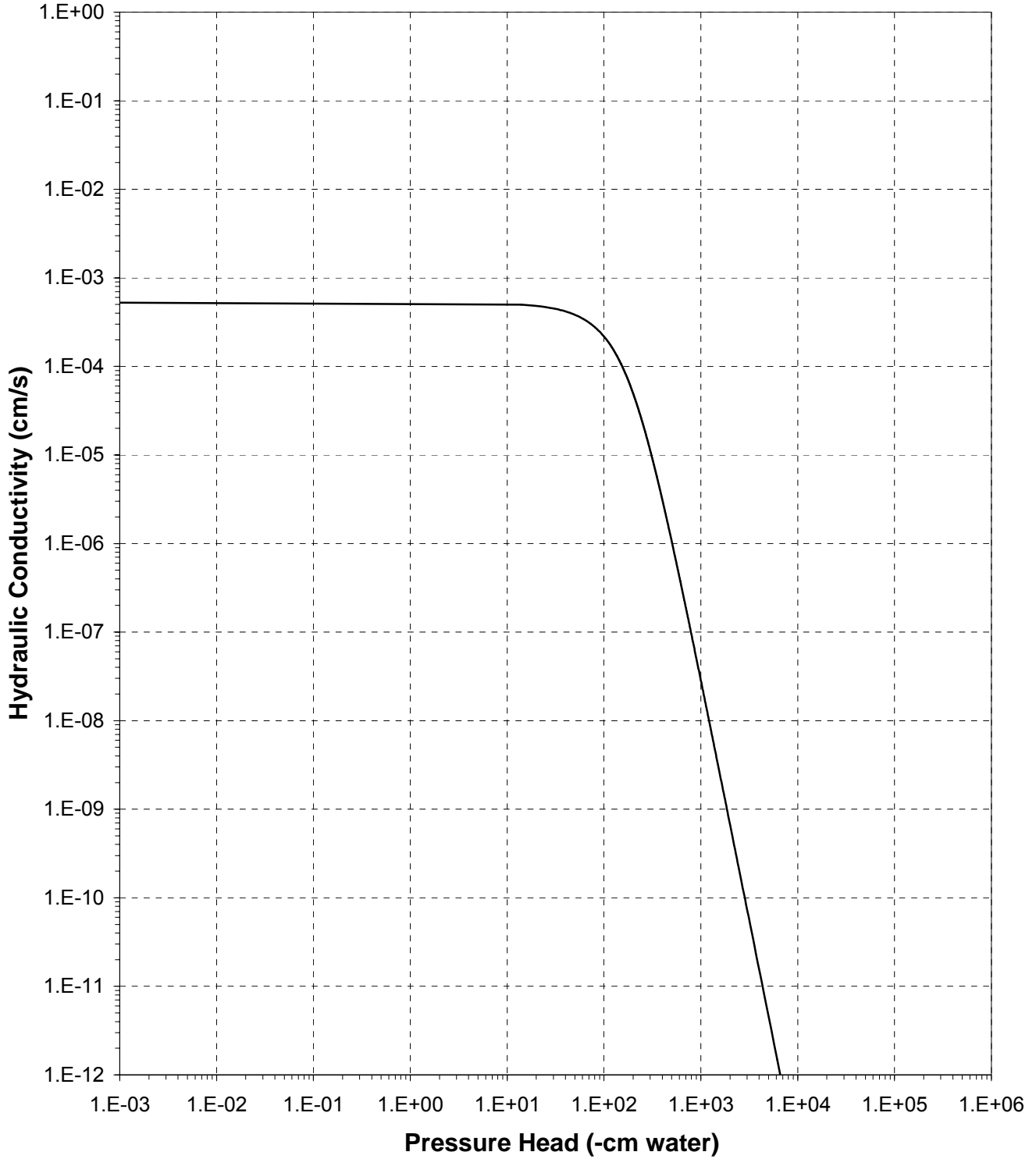





**Moisture Retention Data**  
**Hanging Column / Pressure Plate**  
 (Soil-Water Characteristic Curve)

Job Name: Barr Engineering Company  
 Job Number: LB10.0170.00  
 Sample Number: Blend 2 (55%)  
 Ring Number: NA  
 Depth: NA

Dry wt. of sample (g): 185.98  
 Tare wt., ring (g): 116.30  
 Tare wt., screen & clamp (g): 27.98  
 Initial sample volume (cm<sup>3</sup>): 140.88  
 Initial dry bulk density (g/cm<sup>3</sup>): 1.32  
 Measured particle density (g/cm<sup>3</sup>): 2.98  
 Initial calculated total porosity (%): 55.75

	Date	Time	Weight* (g)	Matric Potential (-cm water)	Moisture Content † (% vol)	
<i>Hanging column:</i>	7-Sep-10	12:00	382.24	0	46.56	##
	13-Sep-10	13:10	373.04	5.0	41.07	##
	19-Sep-10	11:40	368.69	21.0	39.43	##
	26-Sep-10	9:45	366.56	76.0	37.32	##
<i>Pressure plate:</i>	4-Oct-10	13:20	351.25	337	21.61	##

Volume Adjusted Data<sup>1</sup>

	Matric Potential (-cm water)	Adjusted Volume (cm <sup>3</sup> )	% Volume Change <sup>2</sup> (%)	Adjusted Density (g/cm <sup>3</sup> )	Adjusted Calculated Porosity (%)
<i>Hanging column:</i>	0.0	111.65	-20.75%	1.67	44.17
	5.0	104.15	-26.07%	1.79	40.15
	21.0	97.47	-30.81%	1.91	36.05
	76.0	97.27	-30.96%	1.91	35.91
<i>Pressure plate:</i>	337	97.12	-31.06%	1.92	35.82

**Comments:**

<sup>1</sup> Applicable if the sample experienced volume changes during testing. 'Volume Adjusted' values represent each of the volume change measurements obtained after saturated hydraulic conductivity testing and throughout hanging column/pressure plate testing. "---" indicates no volume changes occurred.

<sup>2</sup> Represents percent volume change from original sample volume. A '+' denotes measured sample swelling, a '-' denotes measured sample settling, and '---' denotes no volume change occurred.

\* Weight including tares

† Assumed density of water is 1.0 g/cm<sup>3</sup>

## Volume adjustments are applicable at this matric potential (see comment #1).

**Technician Notes:**

*Laboratory analysis by:* K. Wright  
*Data entered by:* K. Wright  
*Checked by:* J. Hines



**Moisture Retention Data**  
**Dew Point Potentiometer / Relative Humidity Box**  
 (Soil-Water Characteristic Curve)

Sample Number: Blend 2 (55%)

Initial sample bulk density (g/cm<sup>3</sup>): 1.32  
 Fraction of bulk sample used (<2.00mm fraction) (%): 100.00

Dry weight\* of dew point potentiometer sample (g): 152.10  
 Tare weight, jar (g): 117.44

	Date	Time	Weight* (g)	Water Potential (-cm water)	Moisture Content <sup>†</sup> (% vol)	
Dew point potentiometer:	23-Sep-10	12:33	152.63	17541	2.93	##
	23-Sep-10	12:26	152.41	44565	1.71	##
	24-Sep-10	8:55	152.35	106875	1.38	##

Volume Adjusted Data<sup>1</sup>

	Water Potential (-cm water)	Adjusted Volume (cm <sup>3</sup> )	% Volume Change <sup>2</sup> (%)	Adjusted Density (g/cm <sup>3</sup> )	Adjusted Calc. Porosity (%)
Dew point potentiometer:	17541	97.12	-31.06%	1.92	35.82
	44565	97.12	-31.06%	1.92	35.82
	106875	97.12	-31.06%	1.92	35.82

Dry weight\* of relative humidity box sample (g): 69.20  
 Tare weight (g): 36.88

	Date	Time	Weight* (g)	Water Potential (-cm water)	Moisture Content <sup>†</sup> (% vol)	
Relative humidity box:	16-Sep-10	10:45	69.32	861325	0.71	##

Volume Adjusted Data<sup>1</sup>

	Water Potential (-cm water)	Adjusted Volume (cm <sup>3</sup> )	% Volume Change <sup>2</sup> (%)	Adjusted Density (g/cm <sup>3</sup> )	Adjusted Calc. Porosity (%)
Relative humidity box:	861325	97.12	-31.06%	1.92	35.82

**Comments:**

<sup>1</sup> Applicable if the sample experienced volume changes during testing. 'Volume Adjusted' values represent the volume change measurements obtained after the last hanging column or pressure plate point. "----" indicates no volume changes occurred.

<sup>2</sup> Represents percent volume change from original sample volume. A '+' denotes measured sample swelling, a '-' denotes measured sample settling, and '---' denotes no volume change occurred.

\* Weight including tares

<sup>†</sup> Adjusted for >2.00mm (#10 sieve) material not used in DPP/RH testing. Assumed moisture content of material >2.00mm is zero, and assumed density of water is 1.0 g/cm<sup>3</sup>.

## Volume adjustments are applicable at this matric potential (see comment #1).

Laboratory analysis by: M. Vigil  
 Data entered by: K. Wright  
 Checked by: J. Hines



### Water Retention Data Points

Sample Number: Blend 2 (55%)

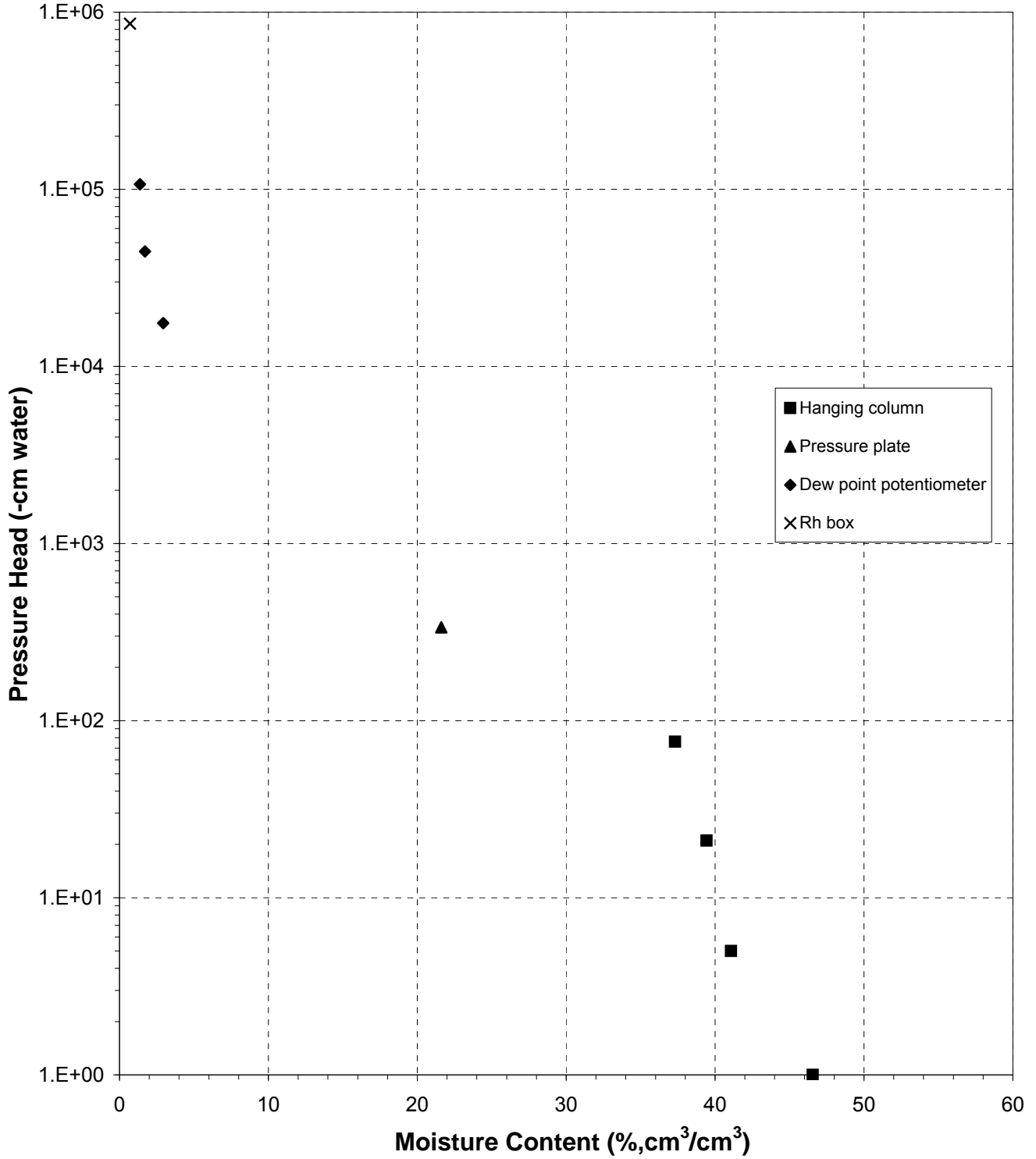



### Predicted Water Retention Curve and Data Points

Sample Number: Blend 2 (55%)

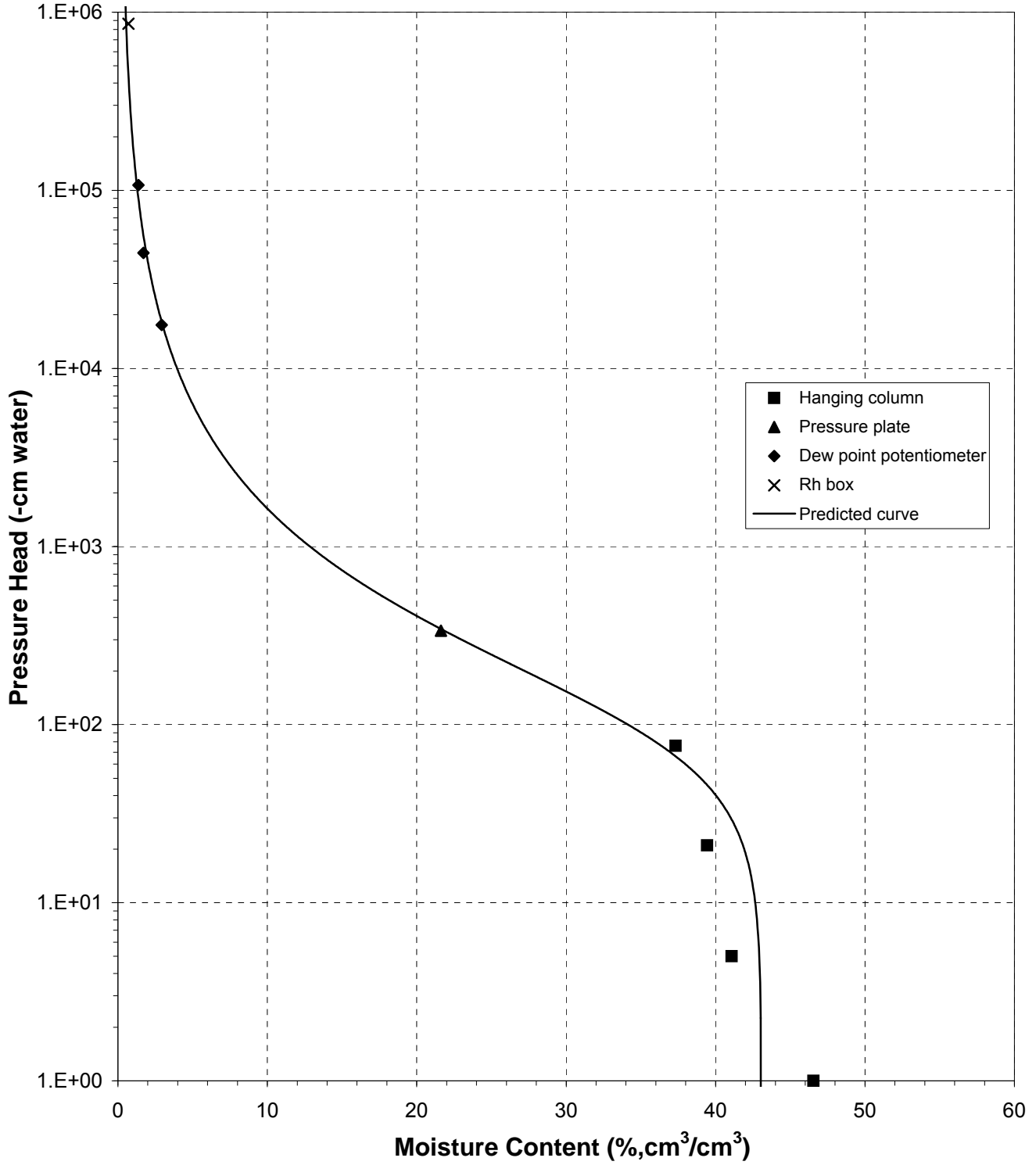



### Plot of Relative Hydraulic Conductivity vs Moisture Content

Sample Number: Blend 2 (55%)

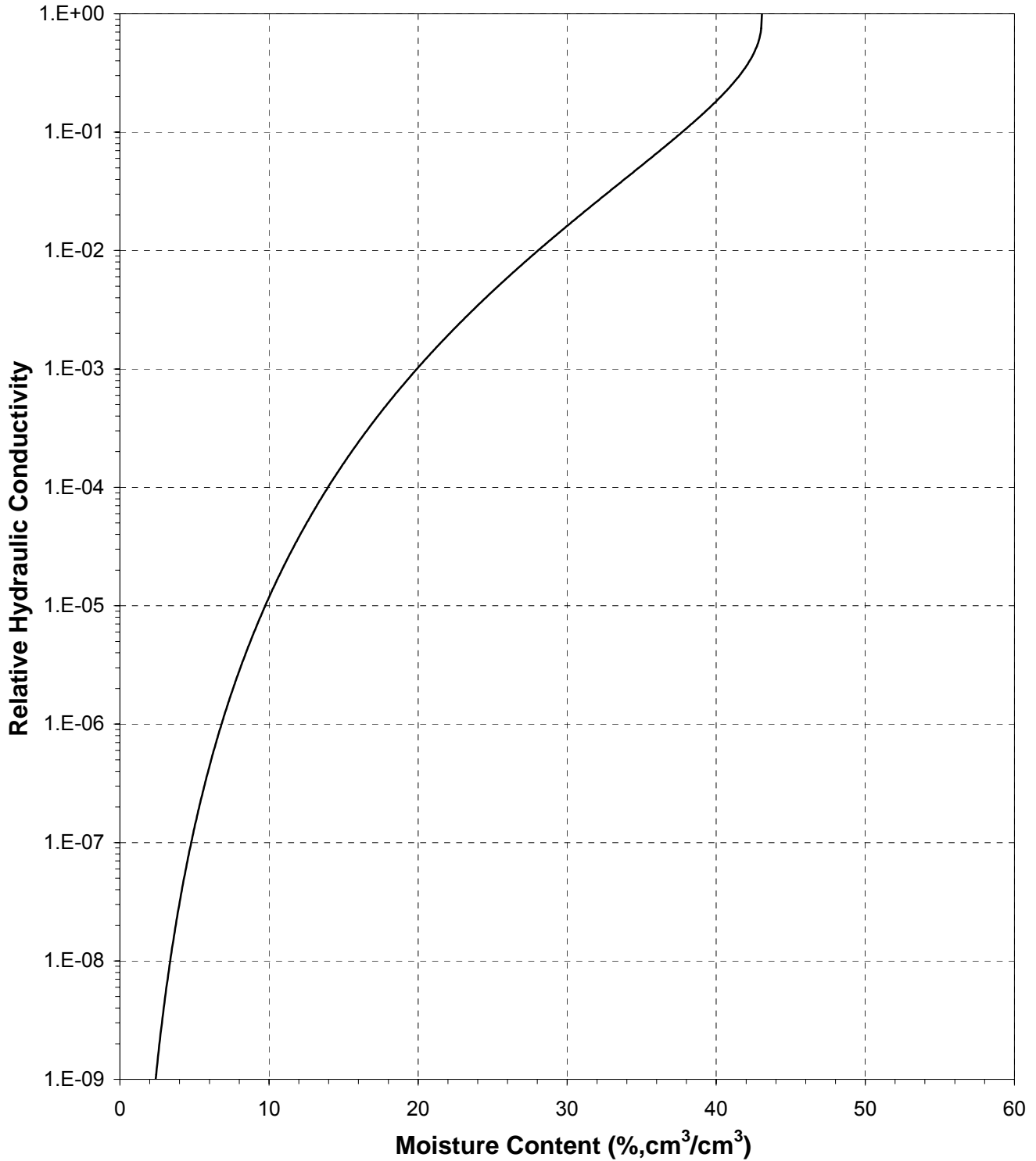



### Plot of Hydraulic Conductivity vs Moisture Content

Sample Number: Blend 2 (55%)

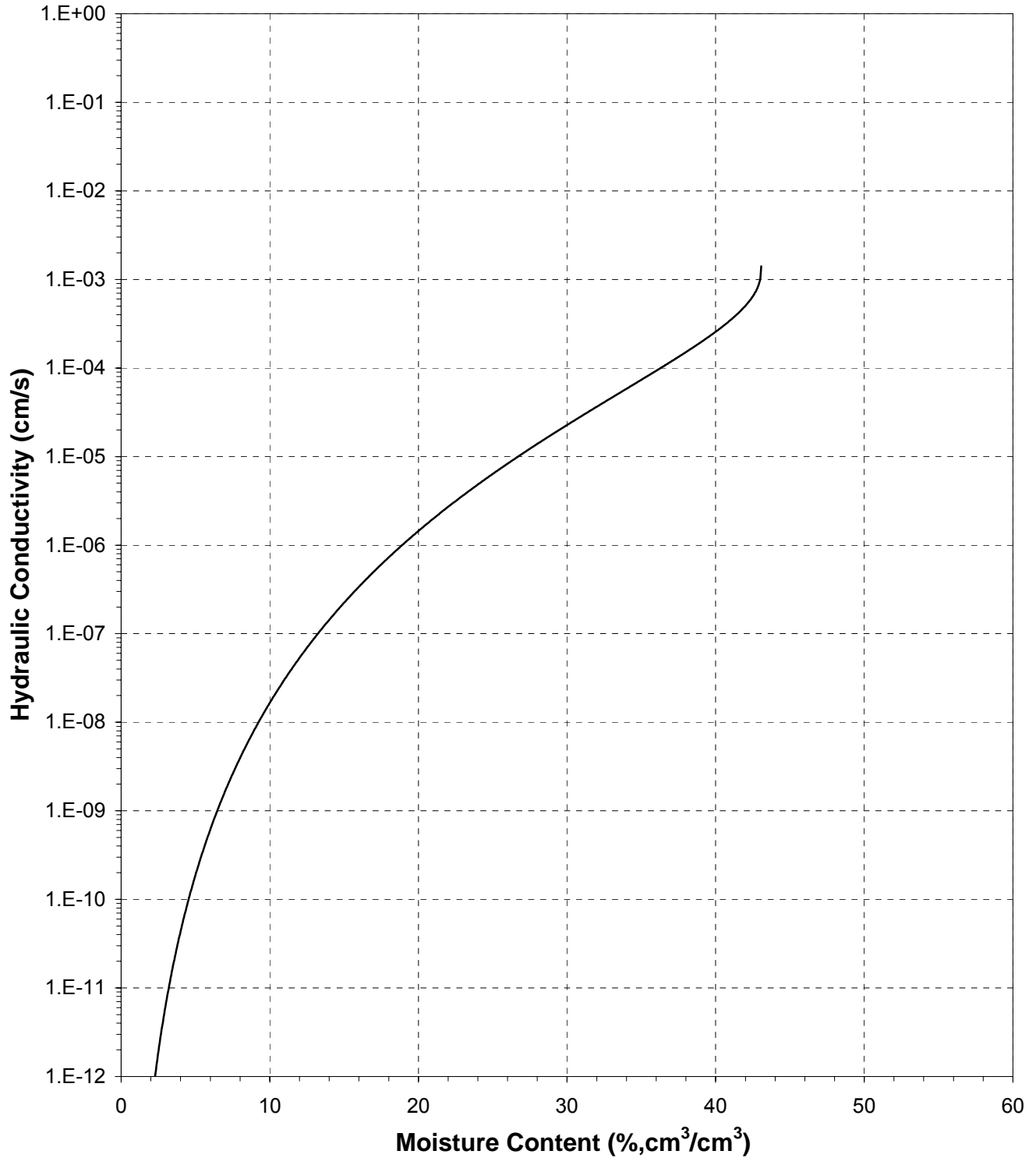



### Plot of Relative Hydraulic Conductivity vs Pressure Head

Sample Number: Blend 2 (55%)

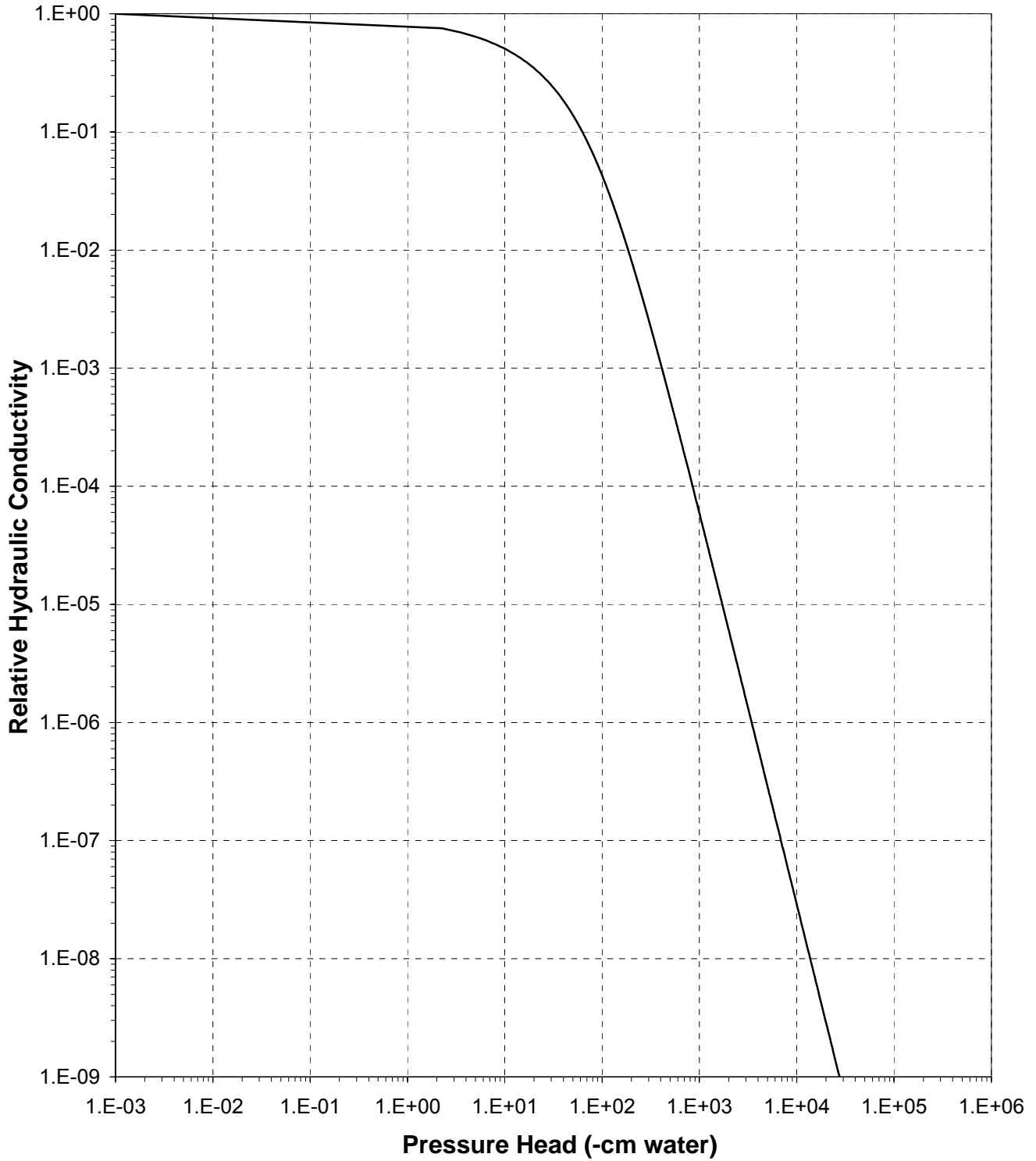



### Plot of Hydraulic Conductivity vs Pressure Head

Sample Number: Blend 2 (55%)

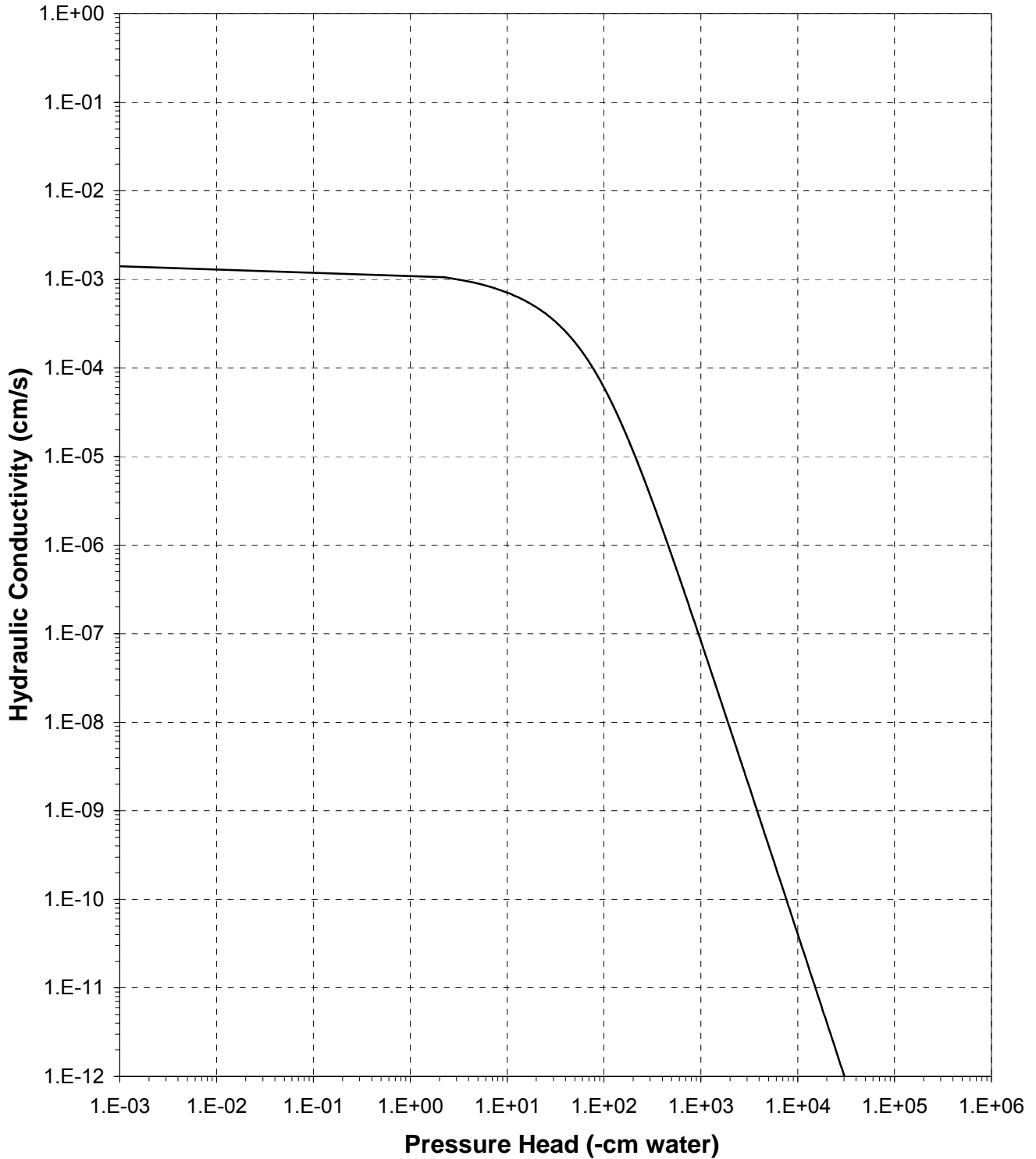





**Moisture Retention Data**  
**Hanging Column / Pressure Plate**  
 (Soil-Water Characteristic Curve)

Job Name: Barr Engineering Company  
 Job Number: LB10.0170.00  
 Sample Number: Blend 3 (40%)  
 Ring Number: NA  
 Depth: NA

Dry wt. of sample (g): 257.44  
 Tare wt., ring (g): 87.14  
 Tare wt., screen & clamp (g): 27.77  
 Initial sample volume (cm<sup>3</sup>): 143.29  
 Initial dry bulk density (g/cm<sup>3</sup>): 1.80  
 Measured particle density (g/cm<sup>3</sup>): 2.98  
 Initial calculated total porosity (%): 39.69

	Date	Time	Weight* (g)	Matric Potential (-cm water)	Moisture Content † (% vol)
<i>Hanging column:</i>	7-Sep-10	11:00	429.21	0	39.68
	13-Sep-10	10:35	428.33	12.0	39.07
	19-Sep-10	10:30	428.01	31.0	38.84
	26-Sep-10	8:40	411.02	101.0	26.99
<i>Pressure plate:</i>	4-Oct-10	11:00	389.97	337	12.30

Volume Adjusted Data<sup>1</sup>

	Matric Potential (-cm water)	Adjusted Volume (cm <sup>3</sup> )	% Volume Change <sup>2</sup> (%)	Adjusted Density (g/cm <sup>3</sup> )	Adjusted Calculated Porosity (%)
<i>Hanging column:</i>	0.0	---	---	---	---
	12.0	---	---	---	---
	31.0	---	---	---	---
	101.0	---	---	---	---
<i>Pressure plate:</i>	337	---	---	---	---

**Comments:**

<sup>1</sup> Applicable if the sample experienced volume changes during testing. 'Volume Adjusted' values represent each of the volume change measurements obtained after saturated hydraulic conductivity testing and throughout hanging column/pressure plate testing. "---" indicates no volume changes occurred.

<sup>2</sup> Represents percent volume change from original sample volume. A '+' denotes measured sample swelling, a '-' denotes measured sample settling, and '---' denotes no volume change occurred.

\* Weight including tares

† Assumed density of water is 1.0 g/cm<sup>3</sup>

‡ Volume adjustments are applicable at this matric potential (see comment #1).

**Technician Notes:**

*Laboratory analysis by:* K. Wright  
*Data entered by:* K. Wright  
*Checked by:* J. Hines



**Moisture Retention Data**  
**Dew Point Potentiometer / Relative Humidity Box**  
 (Soil-Water Characteristic Curve)

Sample Number: Blend 3 (40%)

Initial sample bulk density (g/cm<sup>3</sup>): 1.80  
 Fraction of bulk sample used (<2.00mm fraction) (%): 100.00

Dry weight\* of dew point potentiometer sample (g): 145.09  
 Tare weight, jar (g): 113.91

	Date	Time	Weight* (g)	Water Potential (-cm water)	Moisture Content <sup>†</sup> (% vol)
Dew point potentiometer:	21-Oct-10	10:03	145.64	16215	3.17
	19-Oct-10	13:30	145.59	36611	2.88
	21-Oct-10	8:33	145.44	138387	2.02

Volume Adjusted Data<sup>1</sup>

	Water Potential (-cm water)	Adjusted Volume (cm <sup>3</sup> )	% Volume Change <sup>2</sup> (%)	Adjusted Density (g/cm <sup>3</sup> )	Adjusted Calc. Porosity (%)
Dew point potentiometer:	16215	---	---	---	---
	36611	---	---	---	---
	138387	---	---	---	---

Dry weight\* of relative humidity box sample (g): 80.32  
 Tare weight (g): 47.61

	Date	Time	Weight* (g)	Water Potential (-cm water)	Moisture Content <sup>†</sup> (% vol)
Relative humidity box:	16-Sep-10	11:05	80.44	861325	0.64

Volume Adjusted Data<sup>1</sup>

	Water Potential (-cm water)	Adjusted Volume (cm <sup>3</sup> )	% Volume Change <sup>2</sup> (%)	Adjusted Density (g/cm <sup>3</sup> )	Adjusted Calc. Porosity (%)
Relative humidity box:	861325	---	---	---	---

**Comments:**

<sup>1</sup> Applicable if the sample experienced volume changes during testing. 'Volume Adjusted' values represent the volume change measurements obtained after the last hanging column or pressure plate point. "----" indicates no volume changes occurred.

<sup>2</sup> Represents percent volume change from original sample volume. A '+' denotes measured sample swelling, a '-' denotes measured sample settling, and '---' denotes no volume change occurred.

\* Weight including tares

<sup>†</sup> Adjusted for >2.00mm (#10 sieve) material not used in DPP/RH testing. Assumed moisture content of material >2.00mm is zero, and assumed density of water is 1.0 g/cm<sup>3</sup>.

<sup>‡</sup> Volume adjustments are applicable at this matric potential (see comment #1).

Laboratory analysis by: K. Wright/M. Vigil  
 Data entered by: K. Wright  
 Checked by: J. Hines



### Water Retention Data Points

Sample Number: Blend 3 (40%)

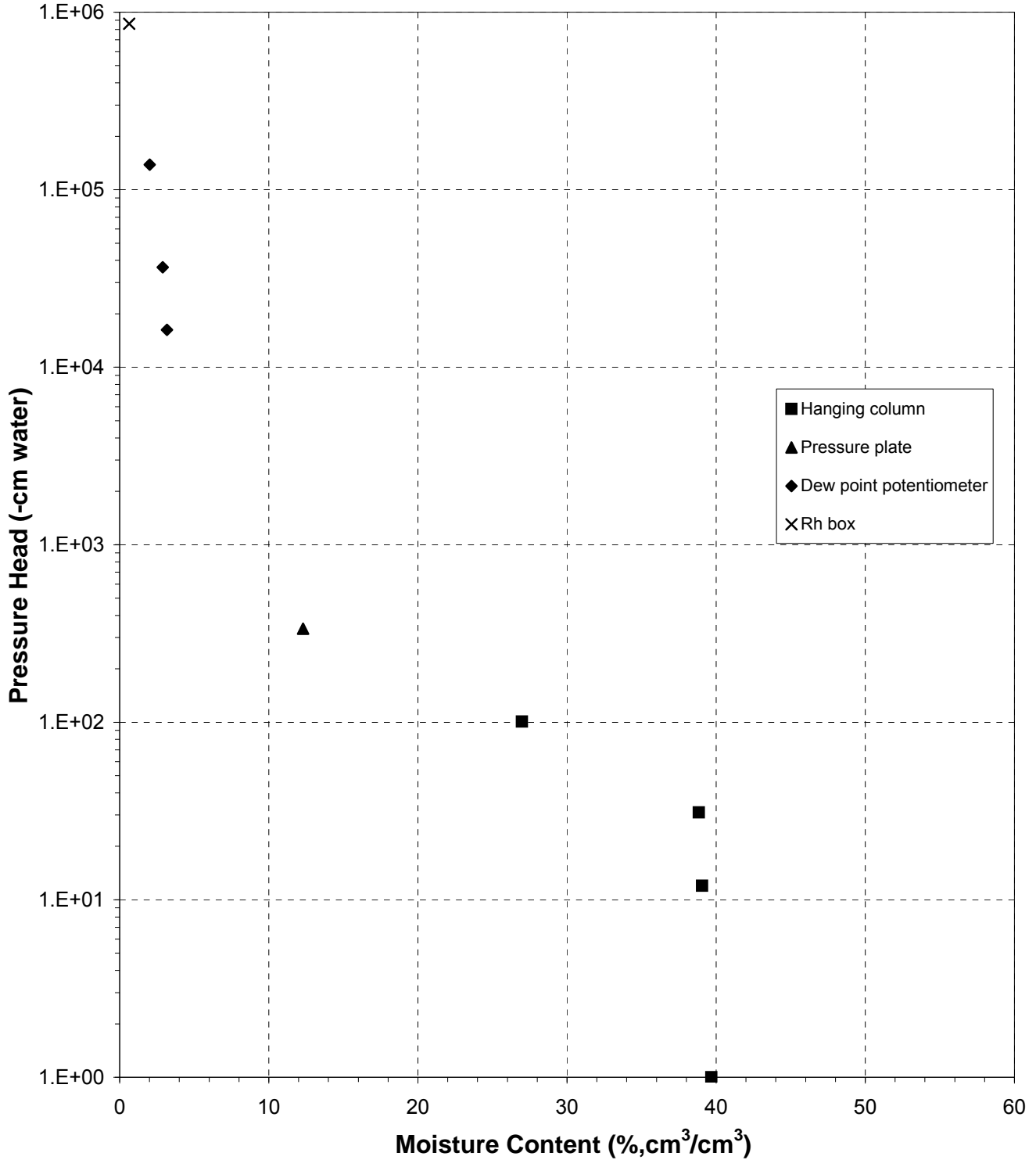



### Predicted Water Retention Curve and Data Points

Sample Number: Blend 3 (40%)

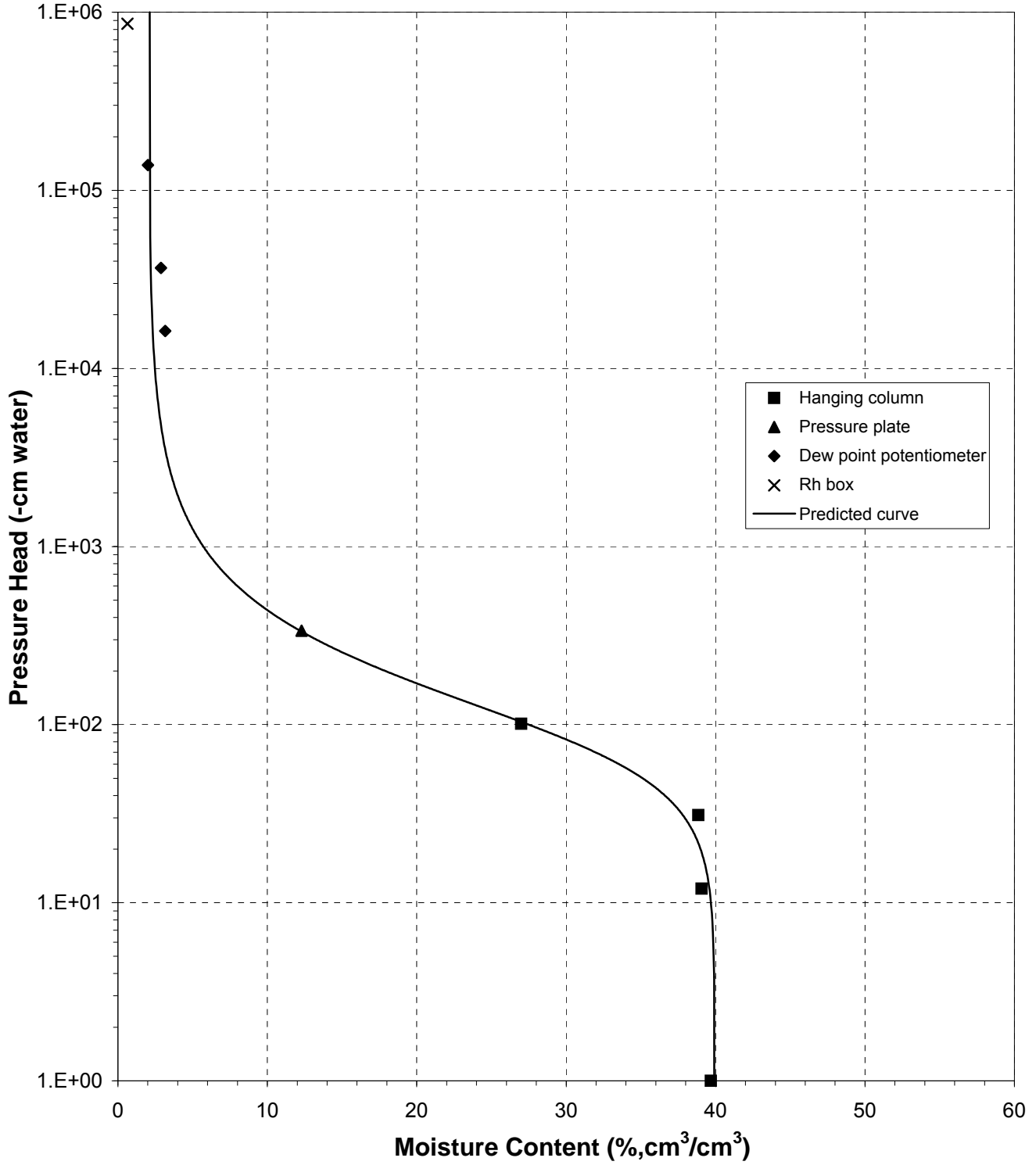



### Plot of Relative Hydraulic Conductivity vs Moisture Content

Sample Number: Blend 3 (40%)

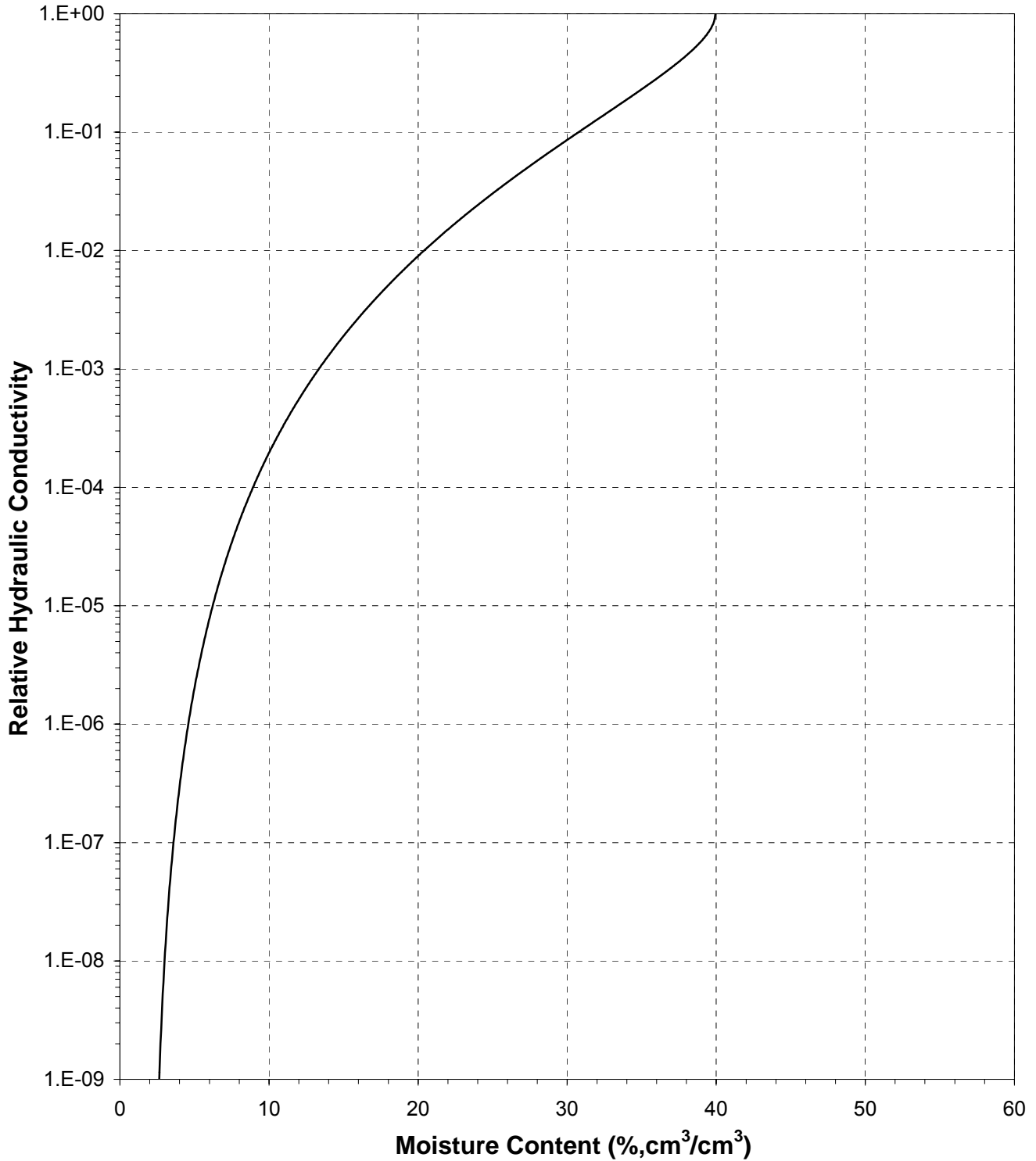



### Plot of Hydraulic Conductivity vs Moisture Content

Sample Number: Blend 3 (40%)

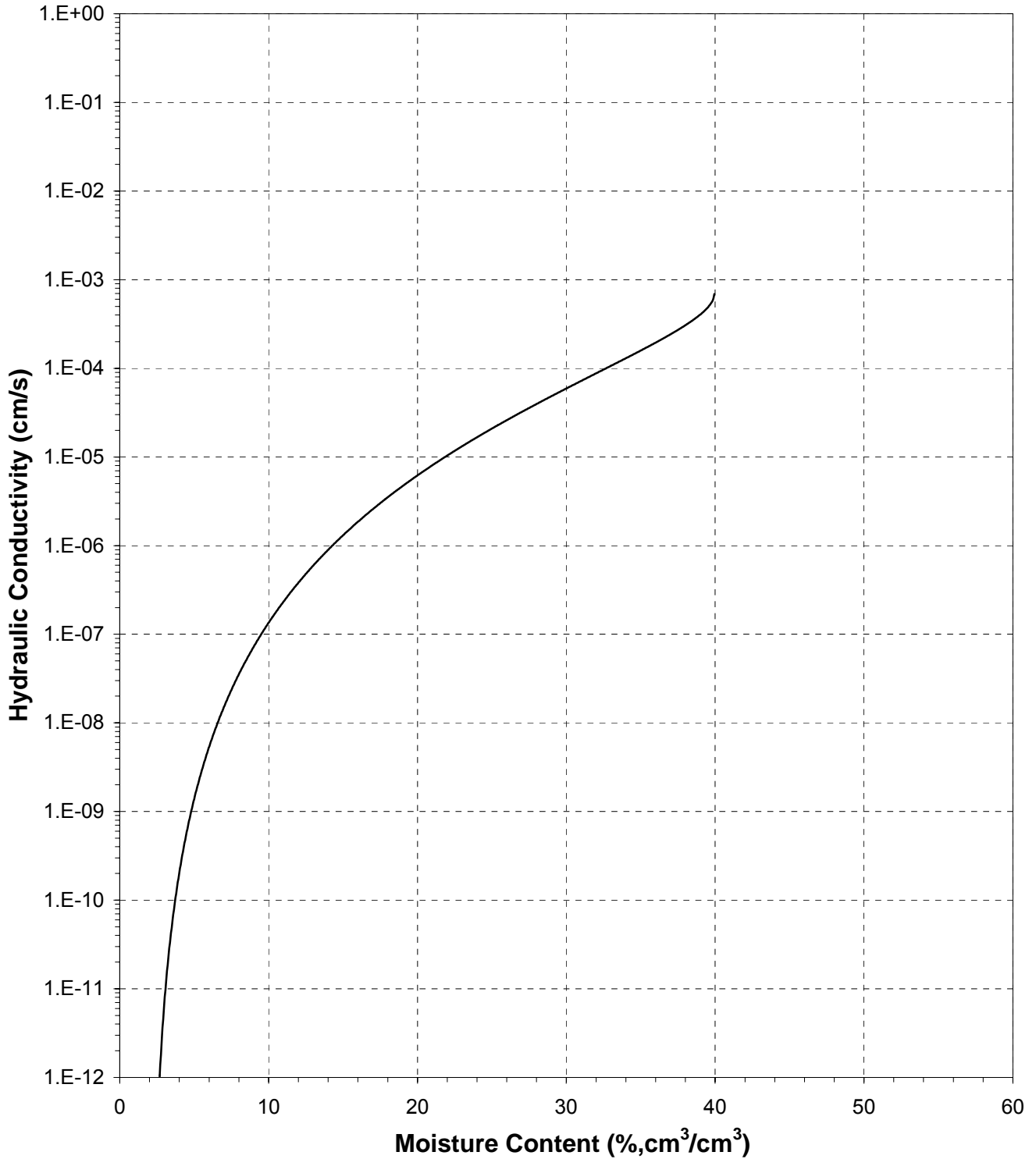



### Plot of Relative Hydraulic Conductivity vs Pressure Head

Sample Number: Blend 3 (40%)

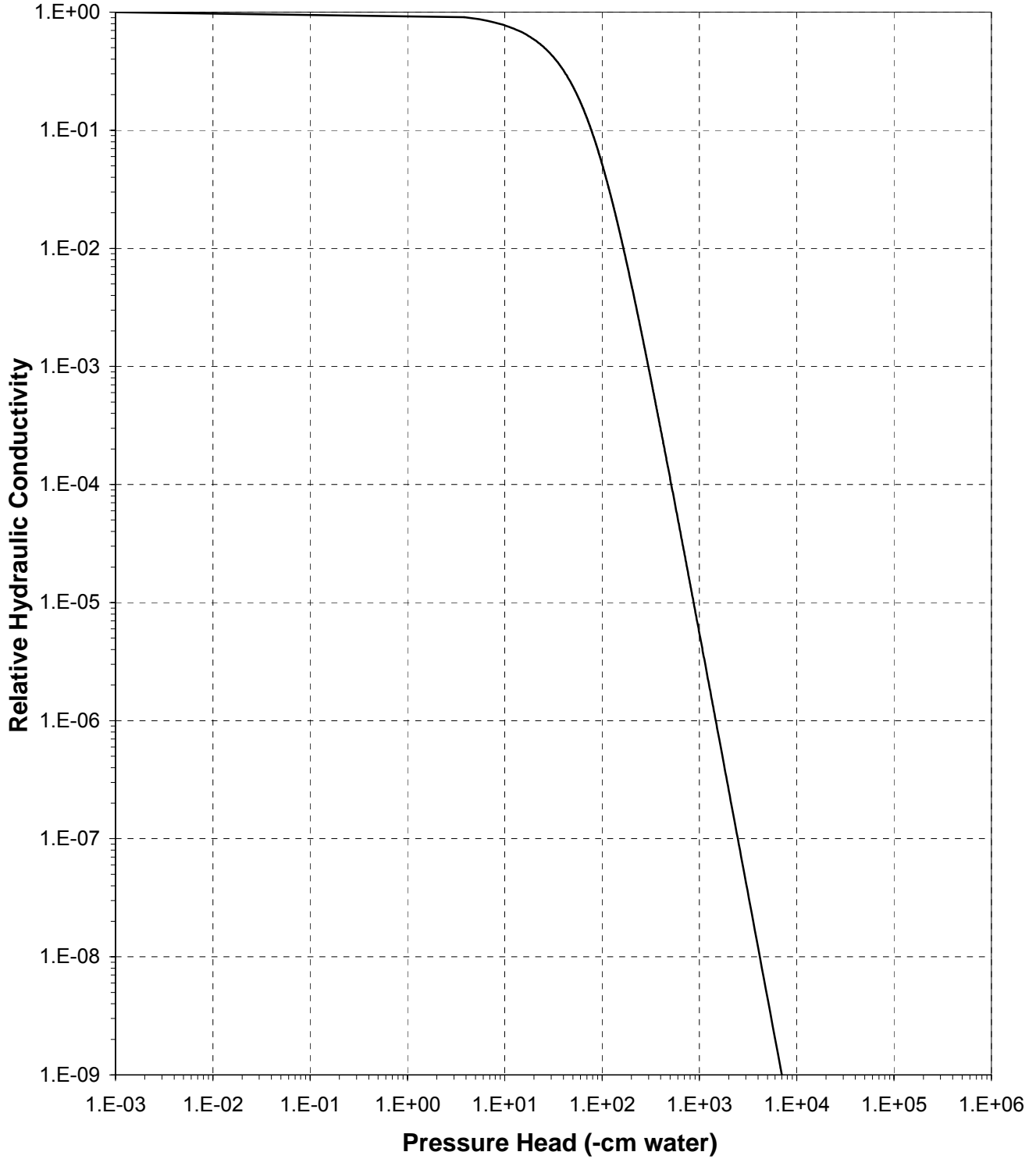



### Plot of Hydraulic Conductivity vs Pressure Head

Sample Number: Blend 3 (40%)

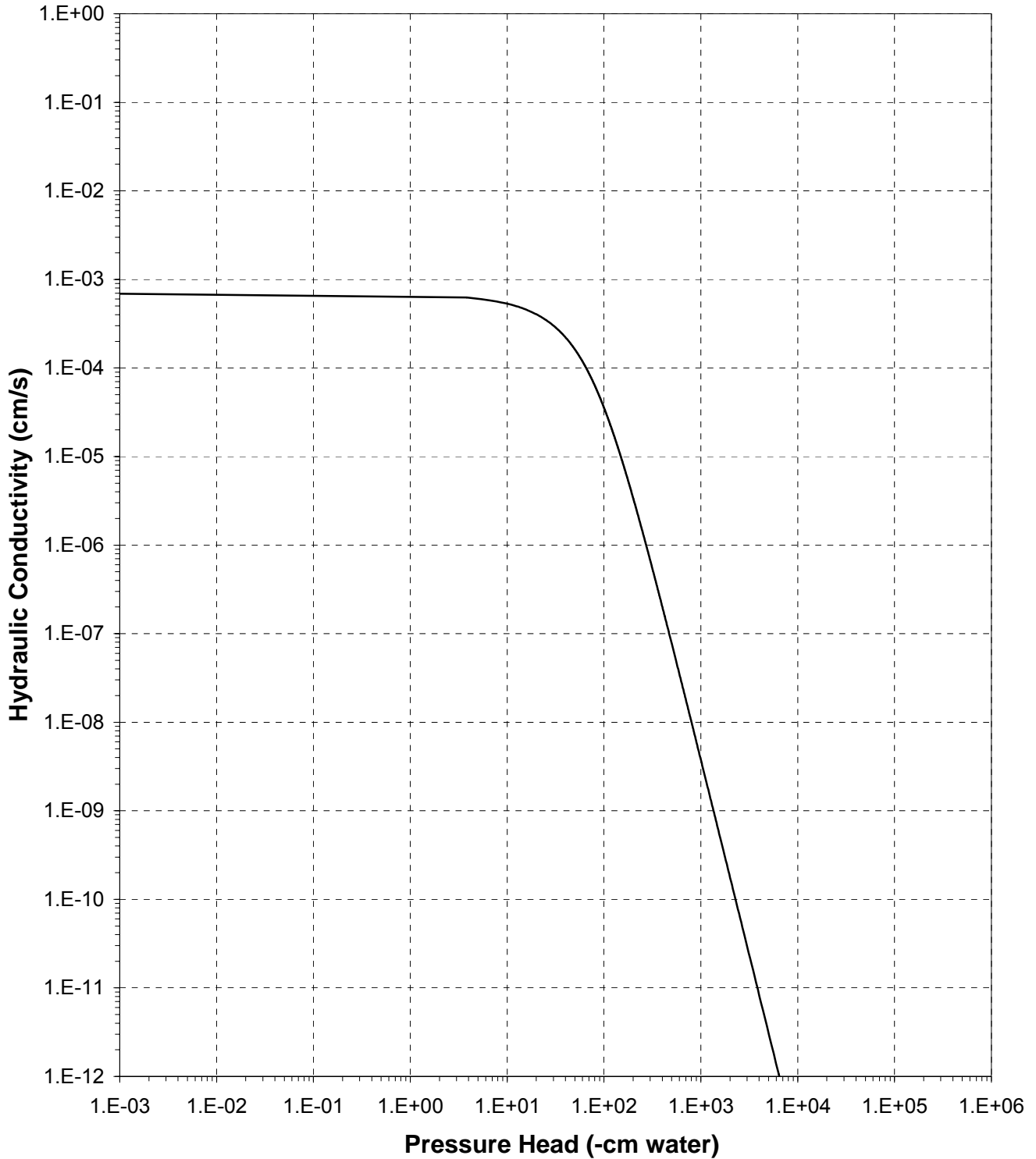





**Moisture Retention Data**  
**Hanging Column / Pressure Plate**  
 (Soil-Water Characteristic Curve)

Job Name: Barr Engineering Company  
 Job Number: LB10.0170.00  
 Sample Number: Blend 3 (45%)  
 Ring Number: NA  
 Depth: NA

Dry wt. of sample (g): 232.98  
 Tare wt., ring (g): 87.13  
 Tare wt., screen & clamp (g): 26.42  
 Initial sample volume (cm<sup>3</sup>): 142.72  
 Initial dry bulk density (g/cm<sup>3</sup>): 1.63  
 Measured particle density (g/cm<sup>3</sup>): 2.98  
 Initial calculated total porosity (%): 45.20

	Date	Time	Weight* (g)	Matric Potential (-cm water)	Moisture Content † (% vol)	
<i>Hanging column:</i>	7-Sep-10	14:45	408.54	0	44.86	##
	13-Sep-10	13:15	404.95	5.0	42.89	##
	19-Sep-10	11:30	401.62	21.0	41.52	##
	26-Sep-10	9:50	399.04	76.0	39.70	##
<i>Pressure plate:</i>	4-Oct-10	13:15	362.41	337	12.06	##

Volume Adjusted Data<sup>1</sup>

	Matric Potential (-cm water)	Adjusted Volume (cm <sup>3</sup> )	% Volume Change <sup>2</sup> (%)	Adjusted Density (g/cm <sup>3</sup> )	Adjusted Calculated Porosity (%)
<i>Hanging column:</i>	0.0	138.24	-3.14%	1.69	43.43
	5.0	136.22	-4.55%	1.71	42.59
	21.0	132.67	-7.04%	1.76	41.05
	76.0	132.27	-7.32%	1.76	40.87
<i>Pressure plate:</i>	337	131.63	-7.77%	1.77	40.59

**Comments:**

<sup>1</sup> Applicable if the sample experienced volume changes during testing. 'Volume Adjusted' values represent each of the volume change measurements obtained after saturated hydraulic conductivity testing and throughout hanging column/pressure plate testing. "---" indicates no volume changes occurred.

<sup>2</sup> Represents percent volume change from original sample volume. A '+' denotes measured sample swelling, a '-' denotes measured sample settling, and '---' denotes no volume change occurred.

\* Weight including tares

† Assumed density of water is 1.0 g/cm<sup>3</sup>

## Volume adjustments are applicable at this matric potential (see comment #1).

**Technician Notes:**

*Laboratory analysis by:* K. Wright  
*Data entered by:* K. Wright  
*Checked by:* J. Hines



**Moisture Retention Data**  
**Dew Point Potentiometer / Relative Humidity Box**  
 (Soil-Water Characteristic Curve)

Sample Number: Blend 3 (45%)

Initial sample bulk density (g/cm<sup>3</sup>): 1.63  
 Fraction of bulk sample used (<2.00mm fraction) (%): 100.00

Dry weight\* of dew point potentiometer sample (g): 146.29  
 Tare weight, jar (g): 115.51

	Date	Time	Weight* (g)	Water Potential (-cm water)	Moisture Content <sup>†</sup> (% vol)	
Dew point potentiometer:	24-Sep-10	14:49	146.64	14481	1.99	##
	24-Sep-10	14:37	146.51	41098	1.29	##
	24-Sep-10	11:36	146.44	141752	0.86	##

Volume Adjusted Data<sup>1</sup>

	Water Potential (-cm water)	Adjusted Volume (cm <sup>3</sup> )	% Volume Change <sup>2</sup> (%)	Adjusted Density (g/cm <sup>3</sup> )	Adjusted Calc. Porosity (%)
Dew point potentiometer:	14481	131.63	-7.77%	1.77	40.59
	41098	131.63	-7.77%	1.77	40.59
	141752	131.63	-7.77%	1.77	40.59

Dry weight\* of relative humidity box sample (g): 75.89  
 Tare weight (g): 38.33

	Date	Time	Weight* (g)	Water Potential (-cm water)	Moisture Content <sup>†</sup> (% vol)	
Relative humidity box:	16-Sep-10	11:05	76.02	861325	0.59	##

Volume Adjusted Data<sup>1</sup>

	Water Potential (-cm water)	Adjusted Volume (cm <sup>3</sup> )	% Volume Change <sup>2</sup> (%)	Adjusted Density (g/cm <sup>3</sup> )	Adjusted Calc. Porosity (%)
Relative humidity box:	861325	131.63	-7.77%	1.77	40.59

**Comments:**

<sup>1</sup> Applicable if the sample experienced volume changes during testing. 'Volume Adjusted' values represent the volume change measurements obtained after the last hanging column or pressure plate point. "----" indicates no volume changes occurred.

<sup>2</sup> Represents percent volume change from original sample volume. A '+' denotes measured sample swelling, a '-' denotes measured sample settling, and '---' denotes no volume change occurred.

\* Weight including tares

<sup>†</sup> Adjusted for >2.00mm (#10 sieve) material not used in DPP/RH testing. Assumed moisture content of material >2.00mm is zero, and assumed density of water is 1.0 g/cm<sup>3</sup>.

## Volume adjustments are applicable at this matric potential (see comment #1).

Laboratory analysis by: M. Vigil  
 Data entered by: K. Wright  
 Checked by: J. Hines



### Water Retention Data Points

Sample Number: Blend 3 (45%)

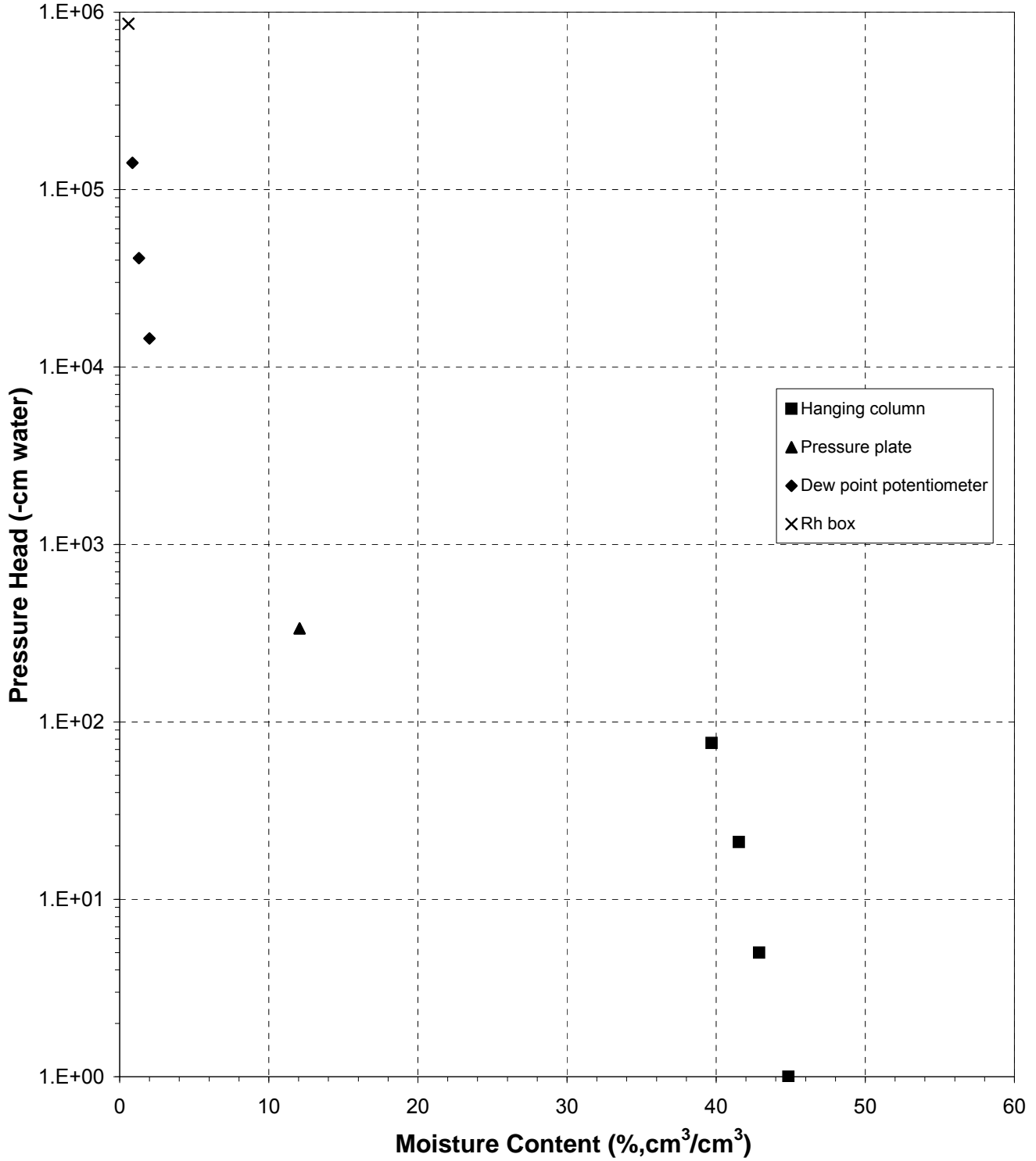



### Predicted Water Retention Curve and Data Points

Sample Number: Blend 3 (45%)

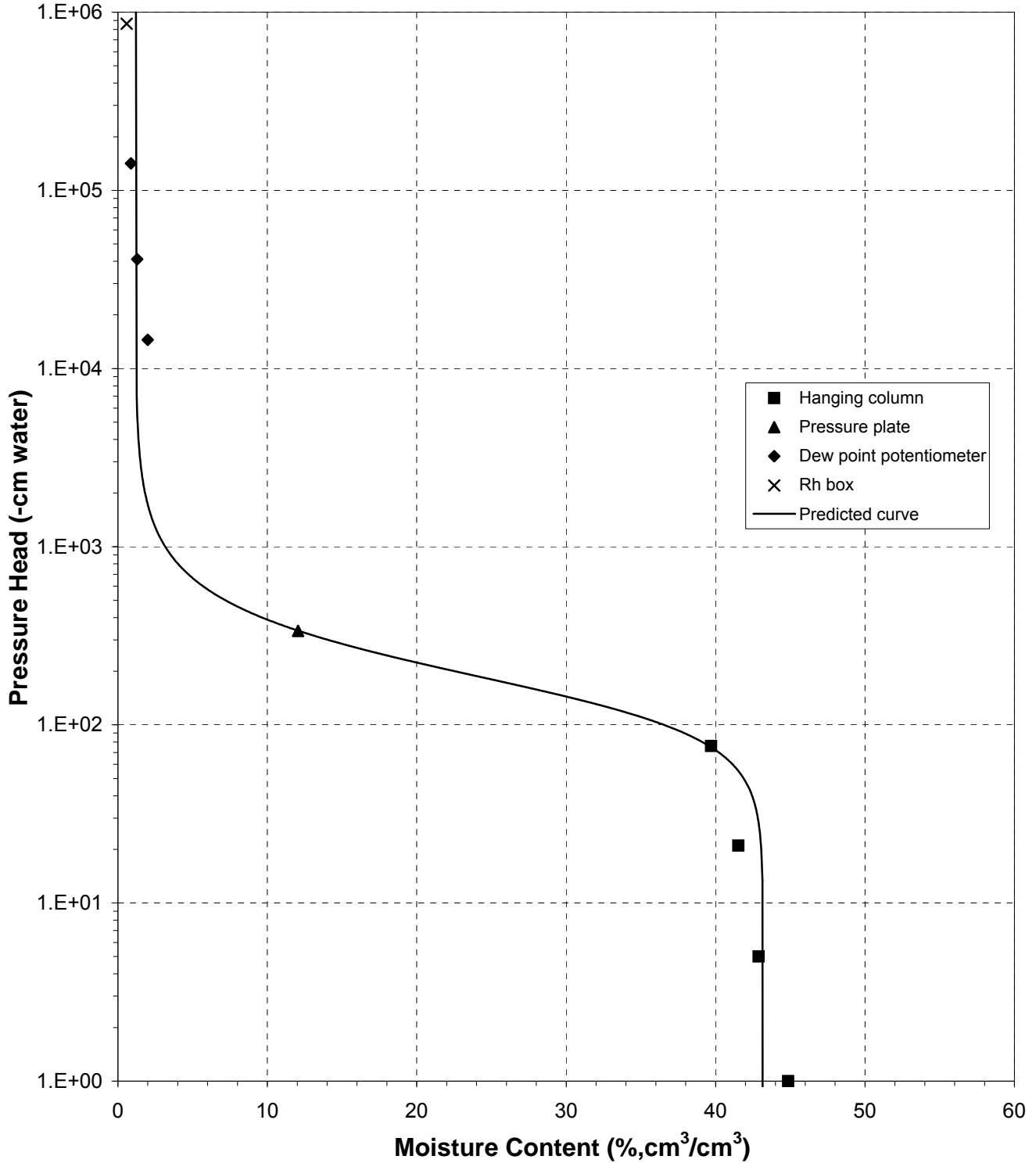



### Plot of Relative Hydraulic Conductivity vs Moisture Content

Sample Number: Blend 3 (45%)

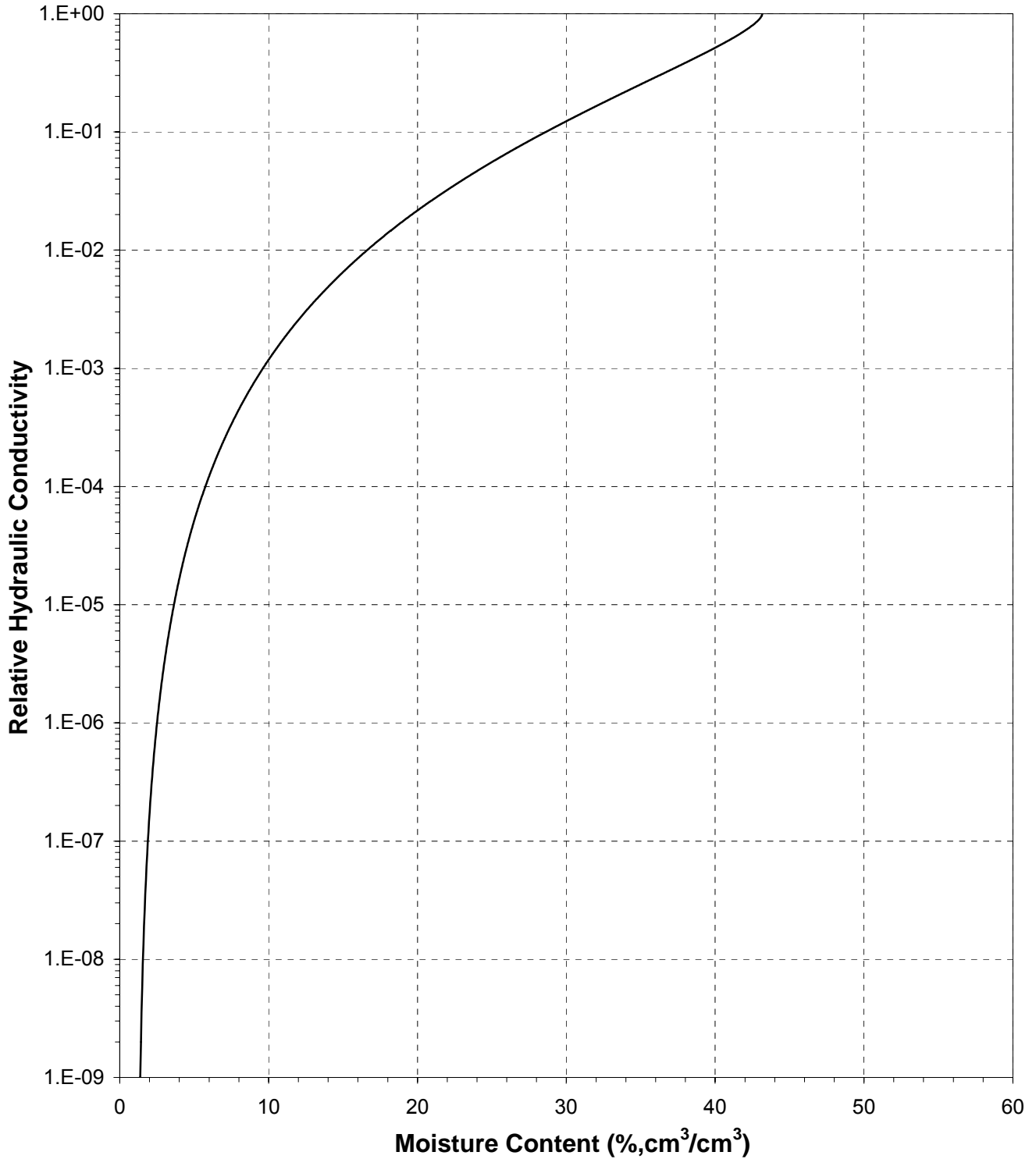



### Plot of Hydraulic Conductivity vs Moisture Content

Sample Number: Blend 3 (45%)

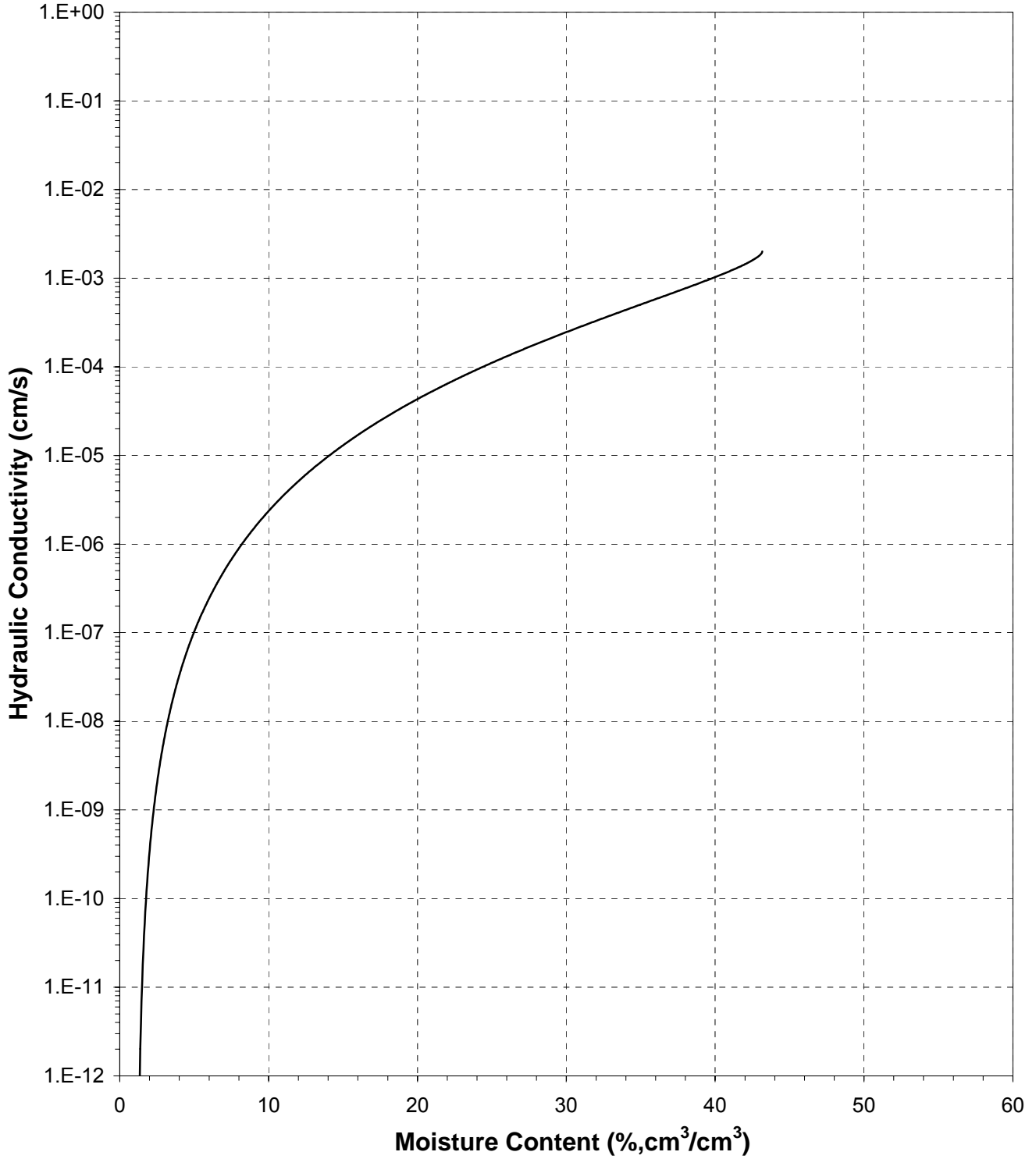



### Plot of Relative Hydraulic Conductivity vs Pressure Head

Sample Number: Blend 3 (45%)

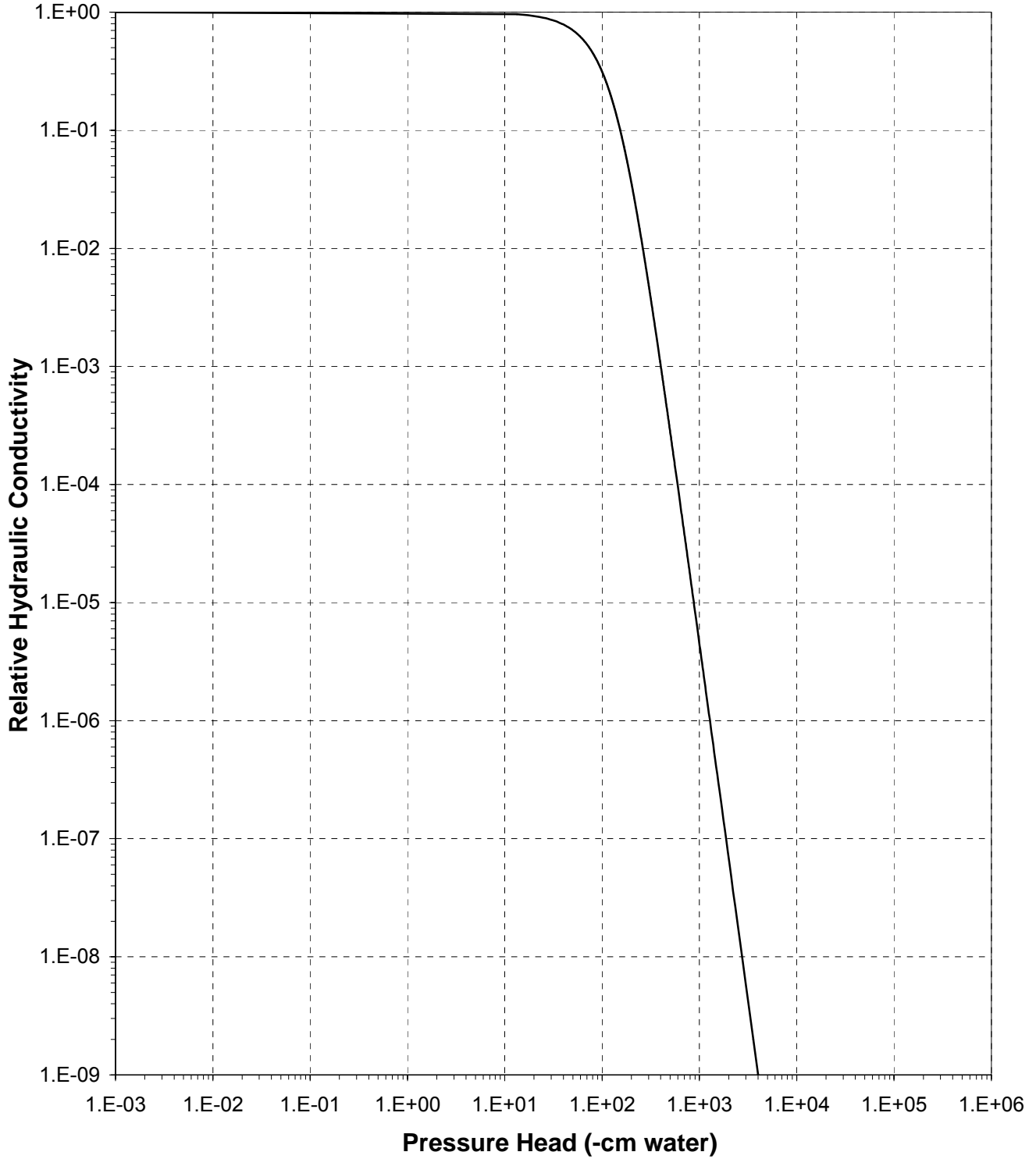



### Plot of Hydraulic Conductivity vs Pressure Head

Sample Number: Blend 3 (45%)

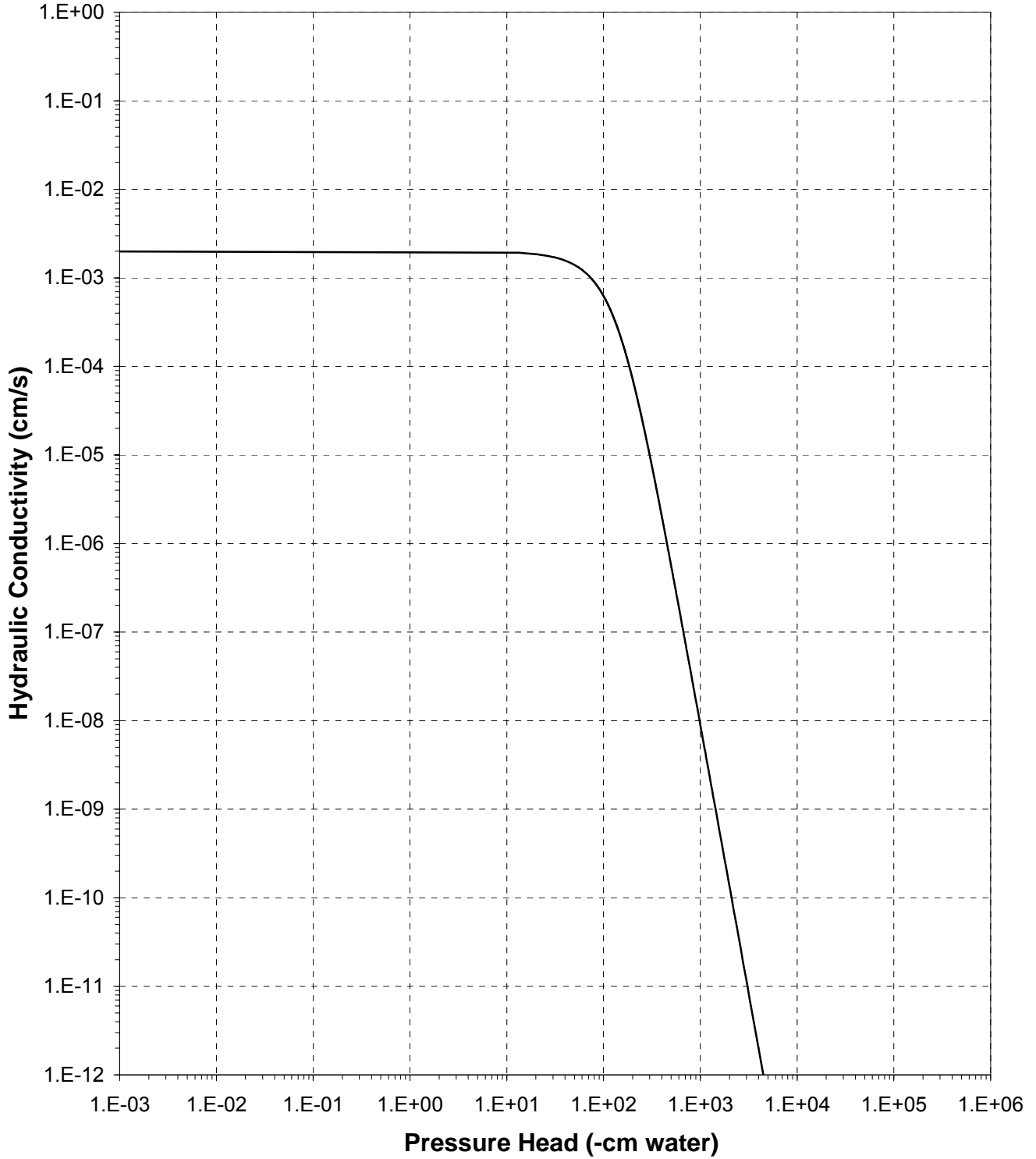





**Moisture Retention Data**  
**Hanging Column / Pressure Plate**  
 (Soil-Water Characteristic Curve)

Job Name: Barr Engineering Company  
 Job Number: LB10.0170.00  
 Sample Number: Blend 3 (55%)  
 Ring Number: NA  
 Depth: NA

Dry wt. of sample (g): 191.84  
 Tare wt., ring (g): 88.41  
 Tare wt., screen & clamp (g): 27.74  
 Initial sample volume (cm<sup>3</sup>): 146.31  
 Initial dry bulk density (g/cm<sup>3</sup>): 1.31  
 Measured particle density (g/cm<sup>3</sup>): 2.98  
 Initial calculated total porosity (%): 55.98

	Date	Time	Weight* (g)	Matric Potential (-cm water)	Moisture Content <sup>†</sup> (% vol)	
<i>Hanging column:</i>	7-Sep-10	14:35	356.77	0	44.03	##
	13-Sep-10	13:05	348.83	5.0	38.74	##
	19-Sep-10	11:40	346.42	21.0	37.05	##
	26-Sep-10	9:40	345.39	76.0	36.71	##
<i>Pressure plate:</i>	4-Oct-10	13:25	320.33	337	12.13	##

Volume Adjusted Data<sup>1</sup>

	Matric Potential (-cm water)	Adjusted Volume (cm <sup>3</sup> )	% Volume Change <sup>2</sup> (%)	Adjusted Density (g/cm <sup>3</sup> )	Adjusted Calculated Porosity (%)
<i>Hanging column:</i>	0.0	110.78	-24.28%	1.73	41.87
	5.0	105.42	-27.94%	1.82	38.91
	21.0	103.72	-29.11%	1.85	37.91
	76.0	101.87	-30.37%	1.88	36.79
<i>Pressure plate:</i>	337	101.74	-30.46%	1.89	36.70

**Comments:**

<sup>1</sup> Applicable if the sample experienced volume changes during testing. 'Volume Adjusted' values represent each of the volume change measurements obtained after saturated hydraulic conductivity testing and throughout hanging column/pressure plate testing. "---" indicates no volume changes occurred.

<sup>2</sup> Represents percent volume change from original sample volume. A '+' denotes measured sample swelling, a '-' denotes measured sample settling, and '---' denotes no volume change occurred.

\* Weight including tares

<sup>†</sup> Assumed density of water is 1.0 g/cm<sup>3</sup>

## Volume adjustments are applicable at this matric potential (see comment #1).

**Technician Notes:**

*Laboratory analysis by:* K. Wright  
*Data entered by:* K. Wright  
*Checked by:* J. Hines



**Moisture Retention Data**  
**Dew Point Potentiometer / Relative Humidity Box**  
 (Soil-Water Characteristic Curve)

Sample Number: Blend 3 (55%)

Initial sample bulk density (g/cm<sup>3</sup>): 1.31  
 Fraction of bulk sample used (<2.00mm fraction) (%): 100.00

Dry weight\* of dew point potentiometer sample (g): 143.99  
 Tare weight, jar (g): 112.60

	Date	Time	Weight* (g)	Water Potential (-cm water)	Moisture Content <sup>†</sup> (% vol)	
Dew point potentiometer:	23-Sep-10	16:17	144.31	12951	1.92	##
	23-Sep-10	16:02	144.21	34673	1.32	##
	23-Sep-10	15:36	144.15	123396	0.96	##

Volume Adjusted Data<sup>1</sup>

	Water Potential (-cm water)	Adjusted Volume (cm <sup>3</sup> )	% Volume Change <sup>2</sup> (%)	Adjusted Density (g/cm <sup>3</sup> )	Adjusted Calc. Porosity (%)
Dew point potentiometer:	12951	101.74	-30.46%	1.89	36.70
	34673	101.74	-30.46%	1.89	36.70
	123396	101.74	-30.46%	1.89	36.70

Dry weight\* of relative humidity box sample (g): 74.59  
 Tare weight (g): 37.81

	Date	Time	Weight* (g)	Water Potential (-cm water)	Moisture Content <sup>†</sup> (% vol)	
Relative humidity box:	16-Sep-10	11:05	74.71	861325	0.63	##

Volume Adjusted Data<sup>1</sup>

	Water Potential (-cm water)	Adjusted Volume (cm <sup>3</sup> )	% Volume Change <sup>2</sup> (%)	Adjusted Density (g/cm <sup>3</sup> )	Adjusted Calc. Porosity (%)
Relative humidity box:	861325	101.74	-30.46%	1.89	36.70

**Comments:**

<sup>1</sup> Applicable if the sample experienced volume changes during testing. 'Volume Adjusted' values represent the volume change measurements obtained after the last hanging column or pressure plate point. "---" indicates no volume changes occurred.

<sup>2</sup> Represents percent volume change from original sample volume. A '+' denotes measured sample swelling, a '-' denotes measured sample settling, and '--' denotes no volume change occurred.

\* Weight including tares

<sup>†</sup> Adjusted for >2.00mm (#10 sieve) material not used in DPP/RH testing. Assumed moisture content of material >2.00mm is zero, and assumed density of water is 1.0 g/cm<sup>3</sup>.

## Volume adjustments are applicable at this matric potential (see comment #1).

Laboratory analysis by: M. Vigil  
 Data entered by: K. Wright  
 Checked by: J. Hines



### Water Retention Data Points

Sample Number: Blend 3 (55%)

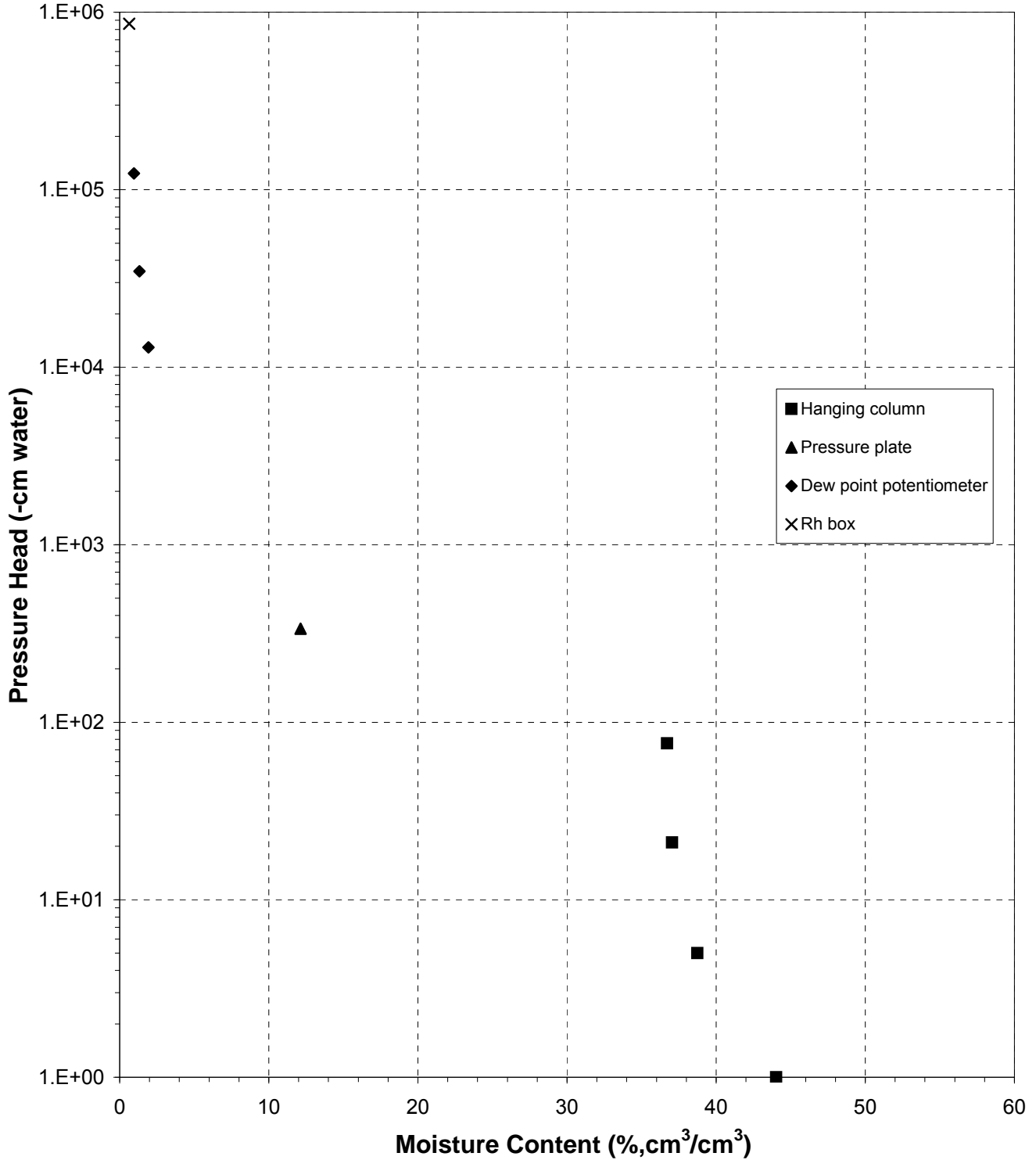



### Predicted Water Retention Curve and Data Points

Sample Number: Blend 3 (55%)

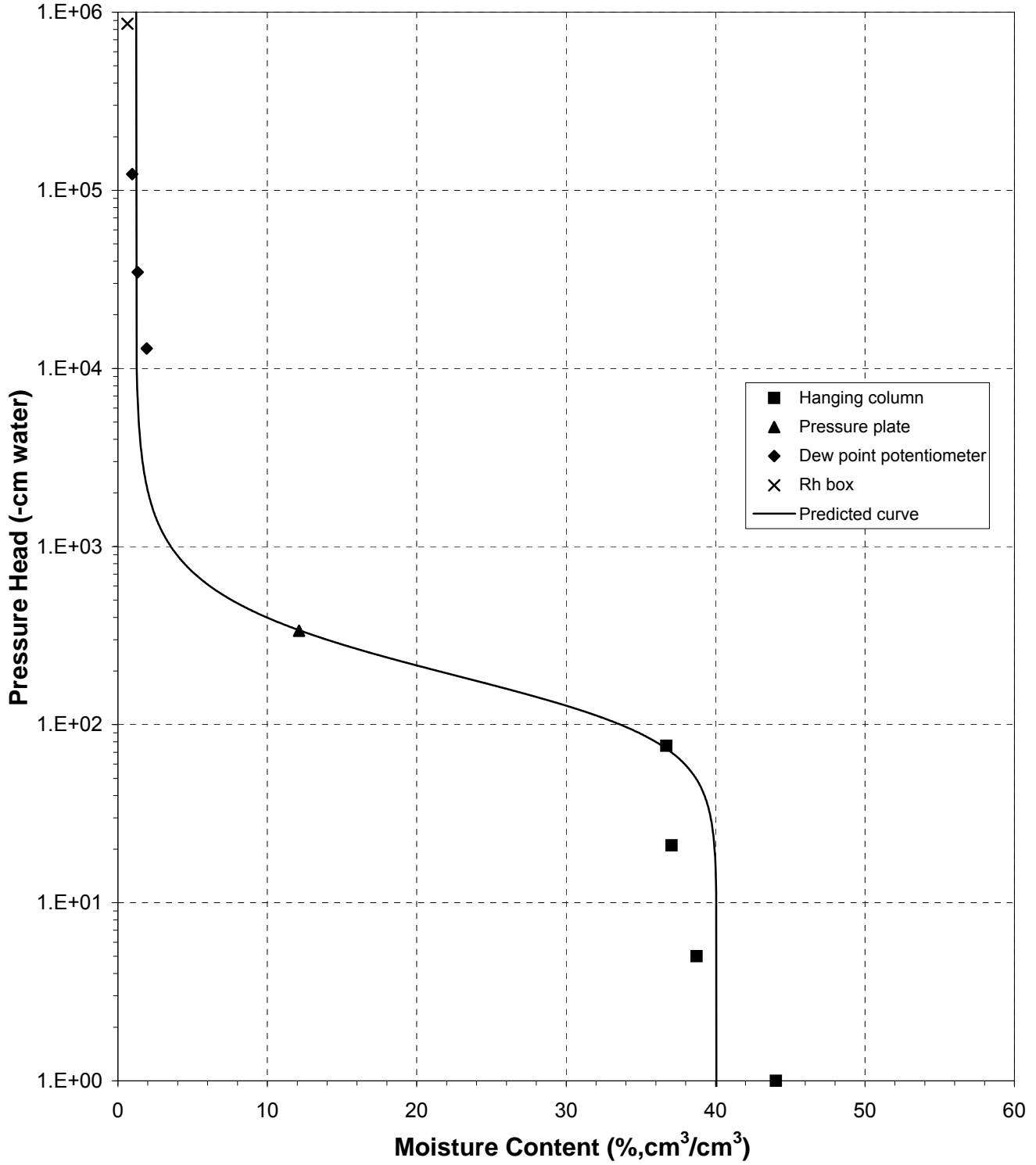



### Plot of Relative Hydraulic Conductivity vs Moisture Content

Sample Number: Blend 3 (55%)

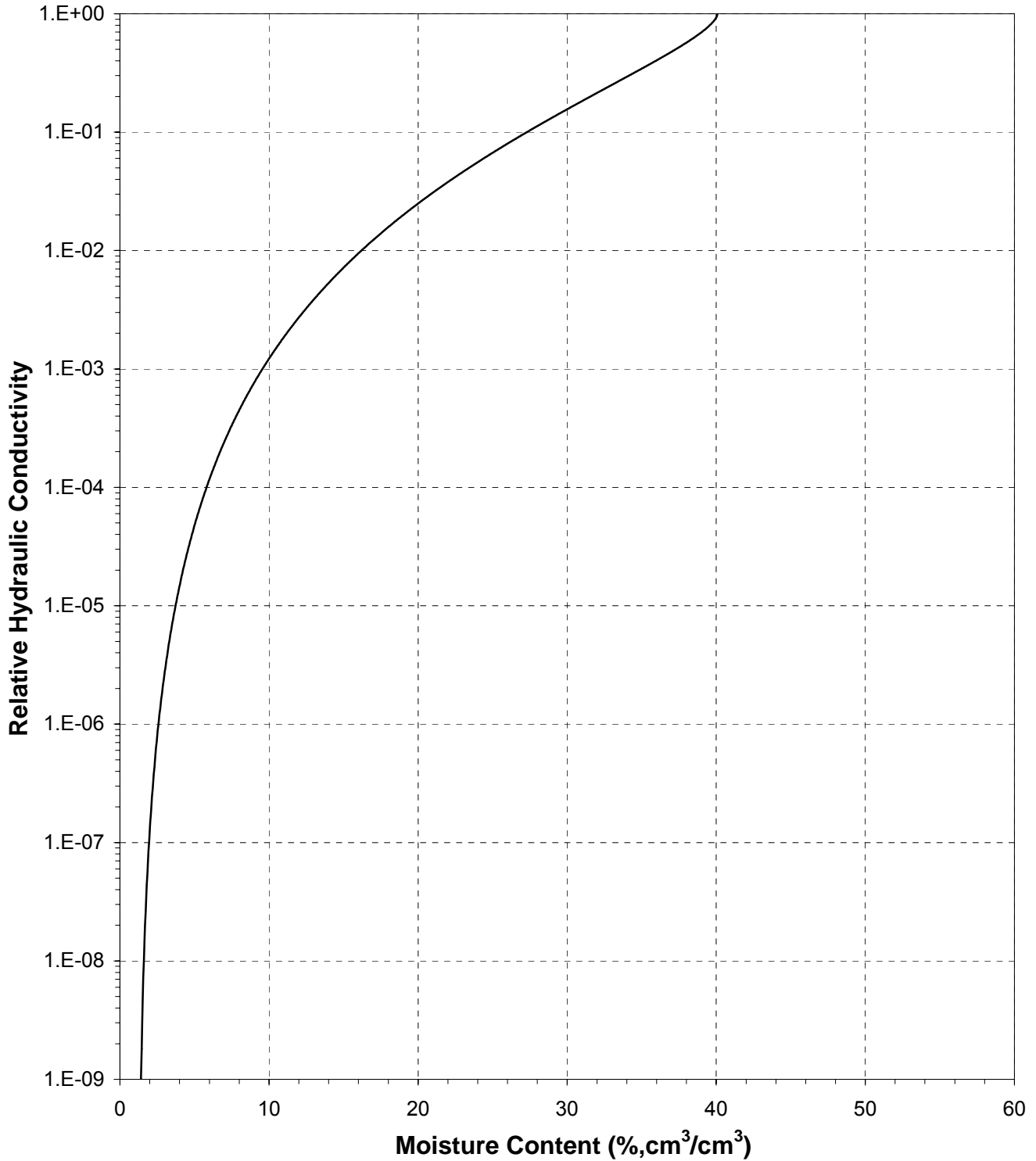



### Plot of Hydraulic Conductivity vs Moisture Content

Sample Number: Blend 3 (55%)

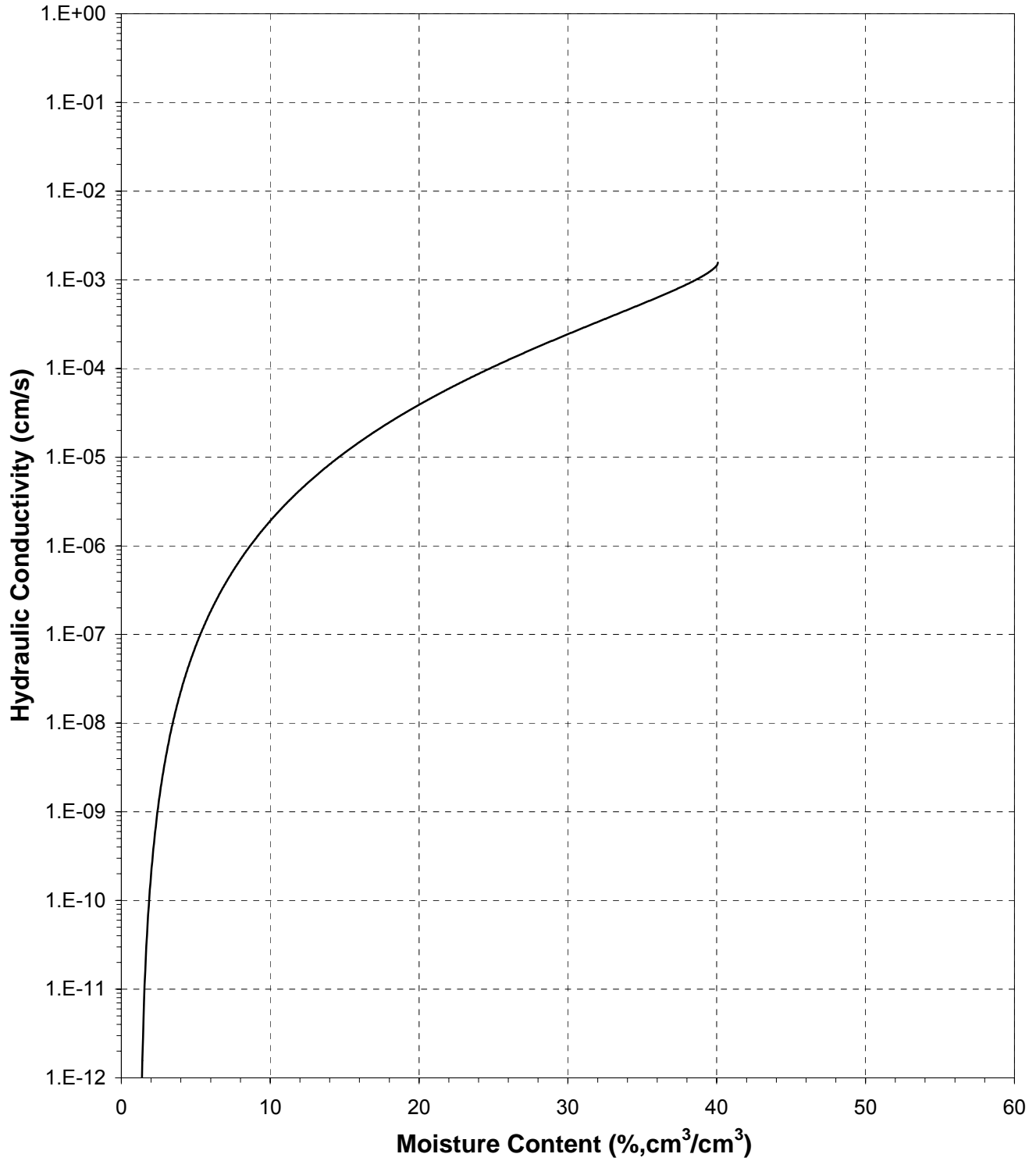



### Plot of Relative Hydraulic Conductivity vs Pressure Head

Sample Number: Blend 3 (55%)

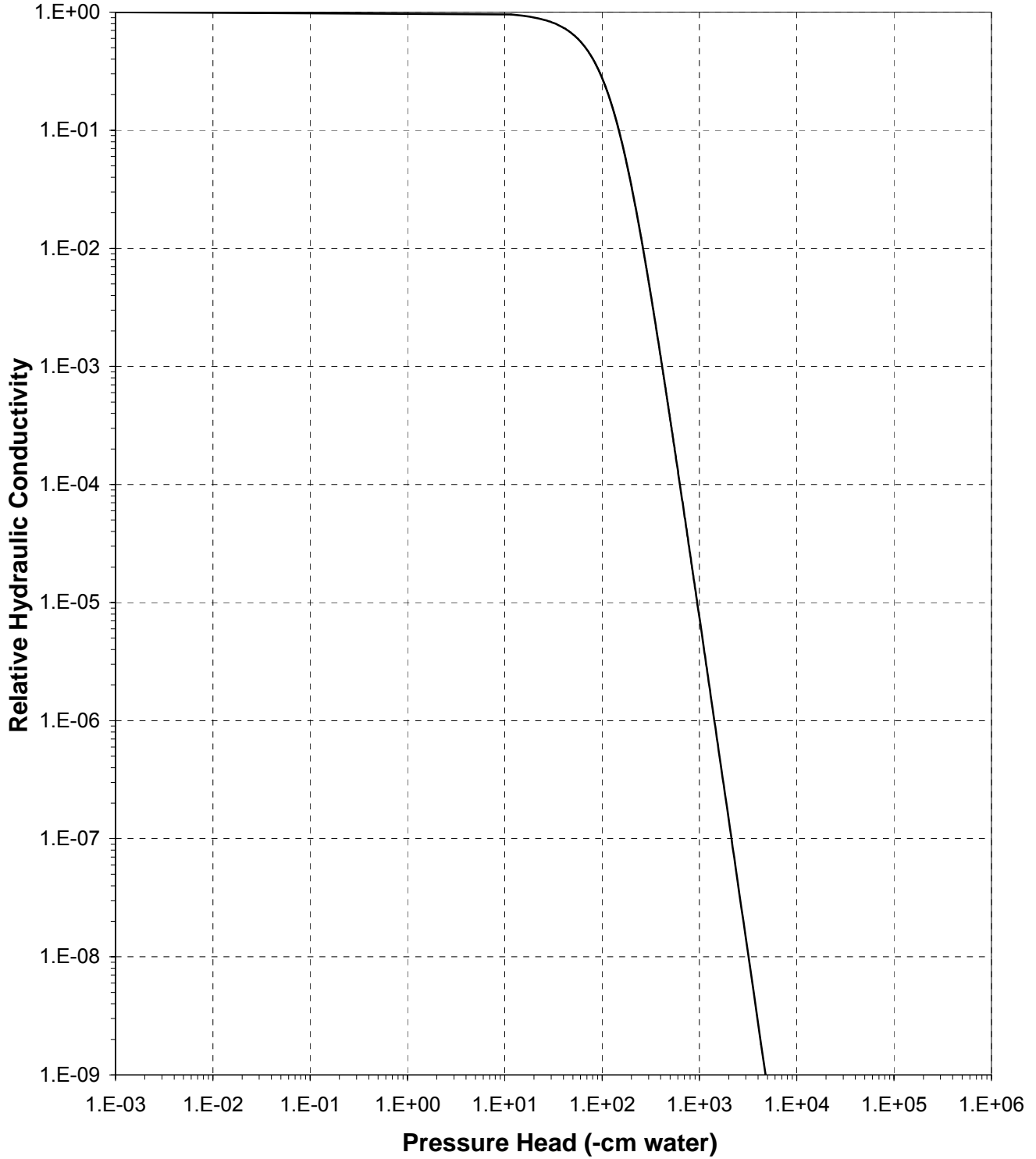



### Plot of Hydraulic Conductivity vs Pressure Head

Sample Number: Blend 3 (55%)

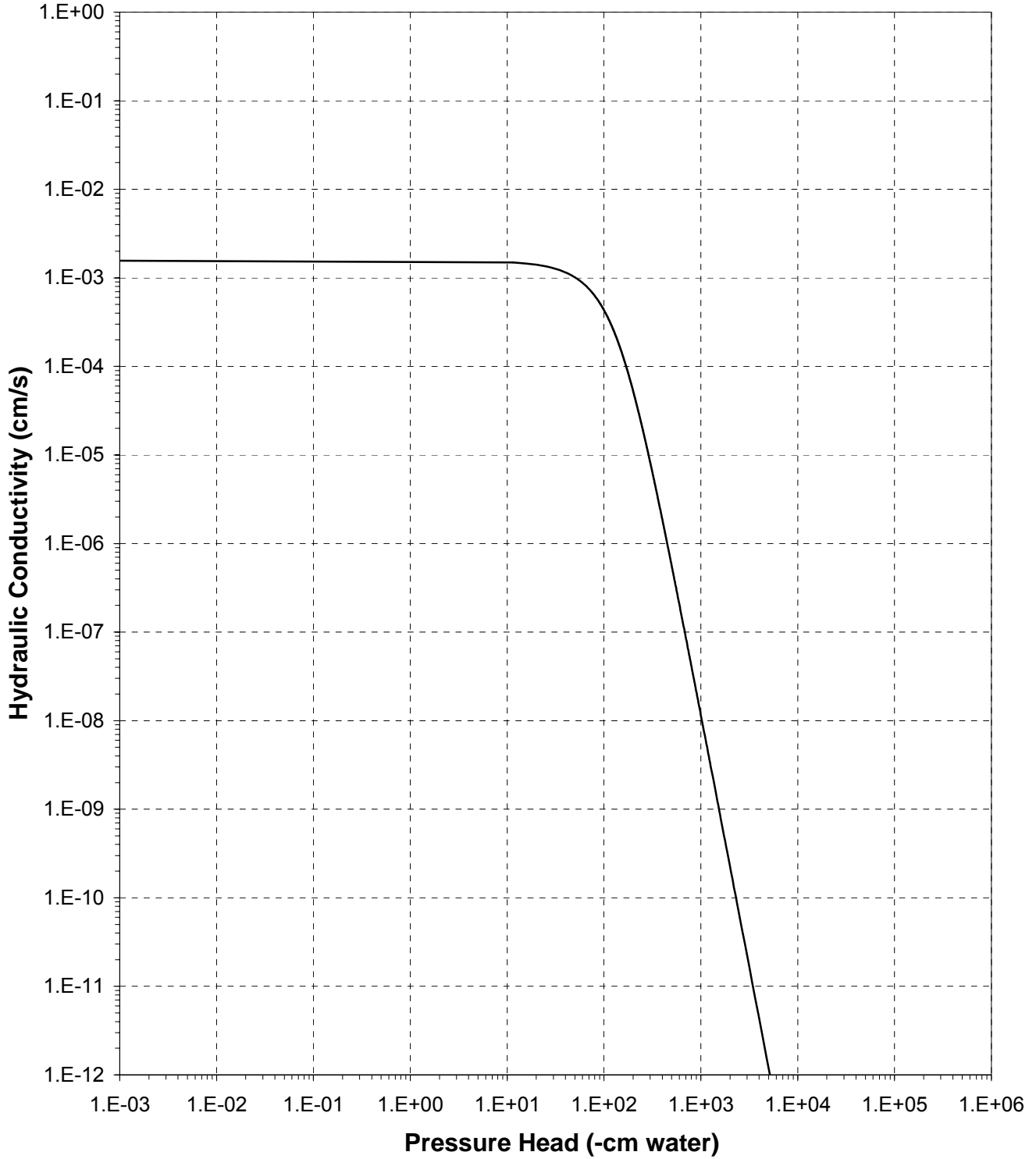





**Moisture Retention Data**  
**Hanging Column / Pressure Plate**  
 (Soil-Water Characteristic Curve)

Job Name: Barr Engineering Company  
 Job Number: LB10.0170.00  
 Sample Number: Blend 4 (44%)  
 Ring Number: NA  
 Depth: NA

Dry wt. of sample (g): 237.11  
 Tare wt., ring (g): 87.15  
 Tare wt., screen & clamp (g): 27.65  
 Initial sample volume (cm<sup>3</sup>): 144.43  
 Initial dry bulk density (g/cm<sup>3</sup>): 1.64  
 Measured particle density (g/cm<sup>3</sup>): 2.98  
 Initial calculated total porosity (%): 44.82

	Date	Time	Weight* (g)	Matric Potential (-cm water)	Moisture Content † (% vol)
<i>Hanging column:</i>	7-Sep-10	14:25	414.20	0	43.13
	13-Sep-10	13:15	413.66	5.0	42.75
	19-Sep-10	11:30	413.34	21.0	42.53
	26-Sep-10	9:50	399.08	76.0	32.66
<i>Pressure plate:</i>	4-Oct-10	13:05	359.55	337	5.29

Volume Adjusted Data<sup>1</sup>

	Matric Potential (-cm water)	Adjusted Volume (cm <sup>3</sup> )	% Volume Change <sup>2</sup> (%)	Adjusted Density (g/cm <sup>3</sup> )	Adjusted Calculated Porosity (%)
<i>Hanging column:</i>	0.0	---	---	---	---
	5.0	---	---	---	---
	21.0	---	---	---	---
	76.0	---	---	---	---
<i>Pressure plate:</i>	337	---	---	---	---

**Comments:**

<sup>1</sup> Applicable if the sample experienced volume changes during testing. 'Volume Adjusted' values represent each of the volume change measurements obtained after saturated hydraulic conductivity testing and throughout hanging column/pressure plate testing. "---" indicates no volume changes occurred.

<sup>2</sup> Represents percent volume change from original sample volume. A '+' denotes measured sample swelling, a '-' denotes measured sample settling, and '---' denotes no volume change occurred.

\* Weight including tares

† Assumed density of water is 1.0 g/cm<sup>3</sup>

‡ Volume adjustments are applicable at this matric potential (see comment #1).

**Technician Notes:**

*Laboratory analysis by:* K. Wright  
*Data entered by:* K. Wright  
*Checked by:* J. Hines



**Moisture Retention Data**  
**Dew Point Potentiometer / Relative Humidity Box**  
 (Soil-Water Characteristic Curve)

Sample Number: Blend 4 (44%)

Initial sample bulk density (g/cm<sup>3</sup>): 1.64  
 Fraction of bulk sample used (<2.00mm fraction) (%): 100.00

Dry weight\* of dew point potentiometer sample (g): 181.08  
 Tare weight, jar (g): 113.12

	Date	Time	Weight* (g)	Water Potential (-cm water)	Moisture Content <sup>†</sup> (% vol)
Dew point potentiometer:	21-Oct-10	9:48	181.58	19274	1.21
	21-Oct-10	8:51	181.46	57619	0.92
	21-Oct-10	14:04	181.35	151440	0.65

Volume Adjusted Data<sup>1</sup>

	Water Potential (-cm water)	Adjusted Volume (cm <sup>3</sup> )	% Volume Change <sup>2</sup> (%)	Adjusted Density (g/cm <sup>3</sup> )	Adjusted Calc. Porosity (%)
Dew point potentiometer:	19274	---	---	---	---
	57619	---	---	---	---
	151440	---	---	---	---

Dry weight\* of relative humidity box sample (g): 79.49  
 Tare weight (g): 44.10

	Date	Time	Weight* (g)	Water Potential (-cm water)	Moisture Content <sup>†</sup> (% vol)
Relative humidity box:	16-Sep-10	11:05	79.59	861325	0.48

Volume Adjusted Data<sup>1</sup>

	Water Potential (-cm water)	Adjusted Volume (cm <sup>3</sup> )	% Volume Change <sup>2</sup> (%)	Adjusted Density (g/cm <sup>3</sup> )	Adjusted Calc. Porosity (%)
Relative humidity box:	861325	---	---	---	---

**Comments:**

<sup>1</sup> Applicable if the sample experienced volume changes during testing. 'Volume Adjusted' values represent the volume change measurements obtained after the last hanging column or pressure plate point. "---" indicates no volume changes occurred.

<sup>2</sup> Represents percent volume change from original sample volume. A '+' denotes measured sample swelling, a '-' denotes measured sample settling, and '--' denotes no volume change occurred.

\* Weight including tares

<sup>†</sup> Adjusted for >2.00mm (#10 sieve) material not used in DPP/RH testing. Assumed moisture content of material >2.00mm is zero, and assumed density of water is 1.0 g/cm<sup>3</sup>.

<sup>‡</sup> Volume adjustments are applicable at this matric potential (see comment #1).

Laboratory analysis by: K. Wright/M. Vigil  
 Data entered by: K. Wright  
 Checked by: J. Hines



### Water Retention Data Points

Sample Number: Blend 4 (44%)

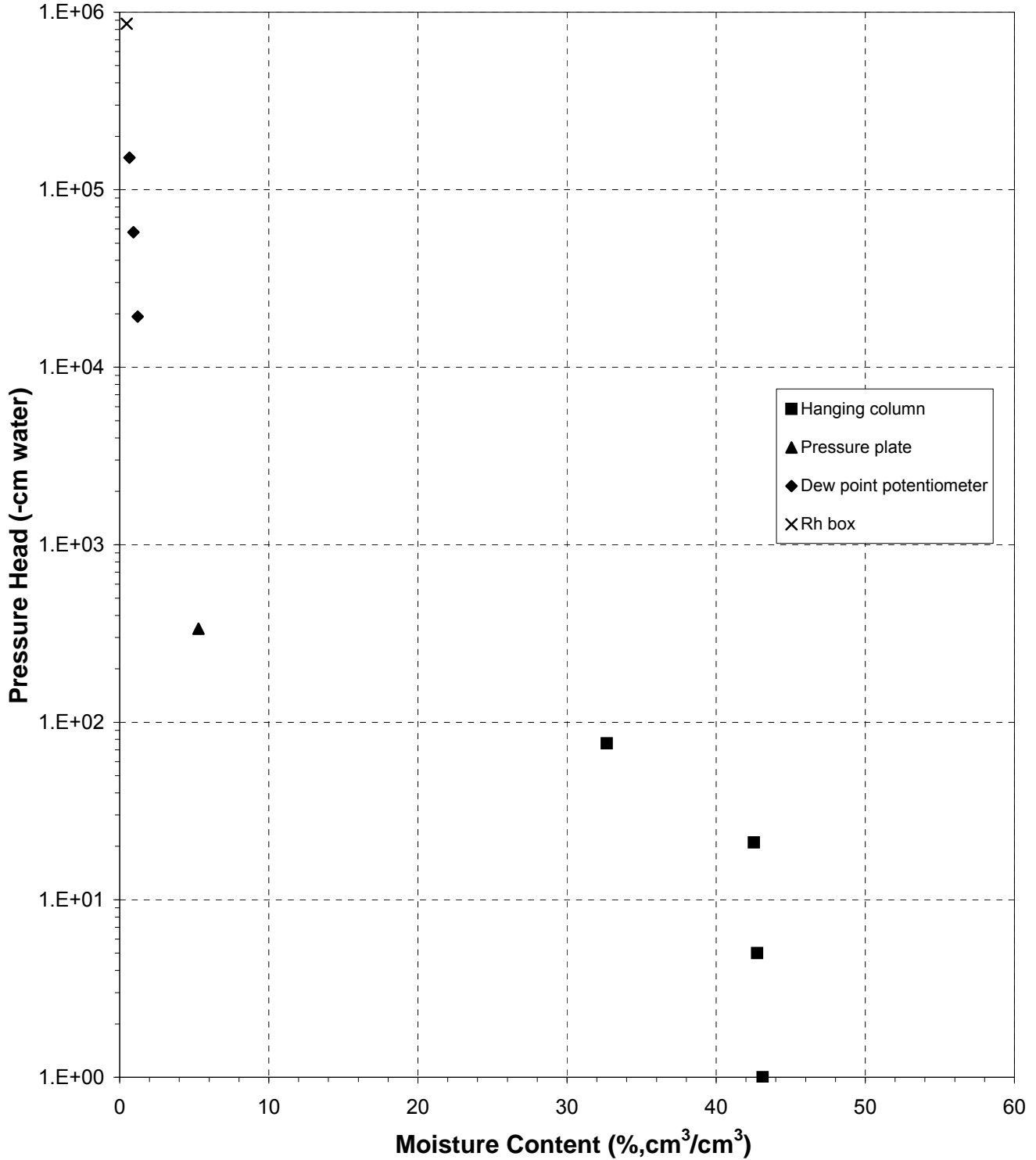



### Predicted Water Retention Curve and Data Points

Sample Number: Blend 4 (44%)

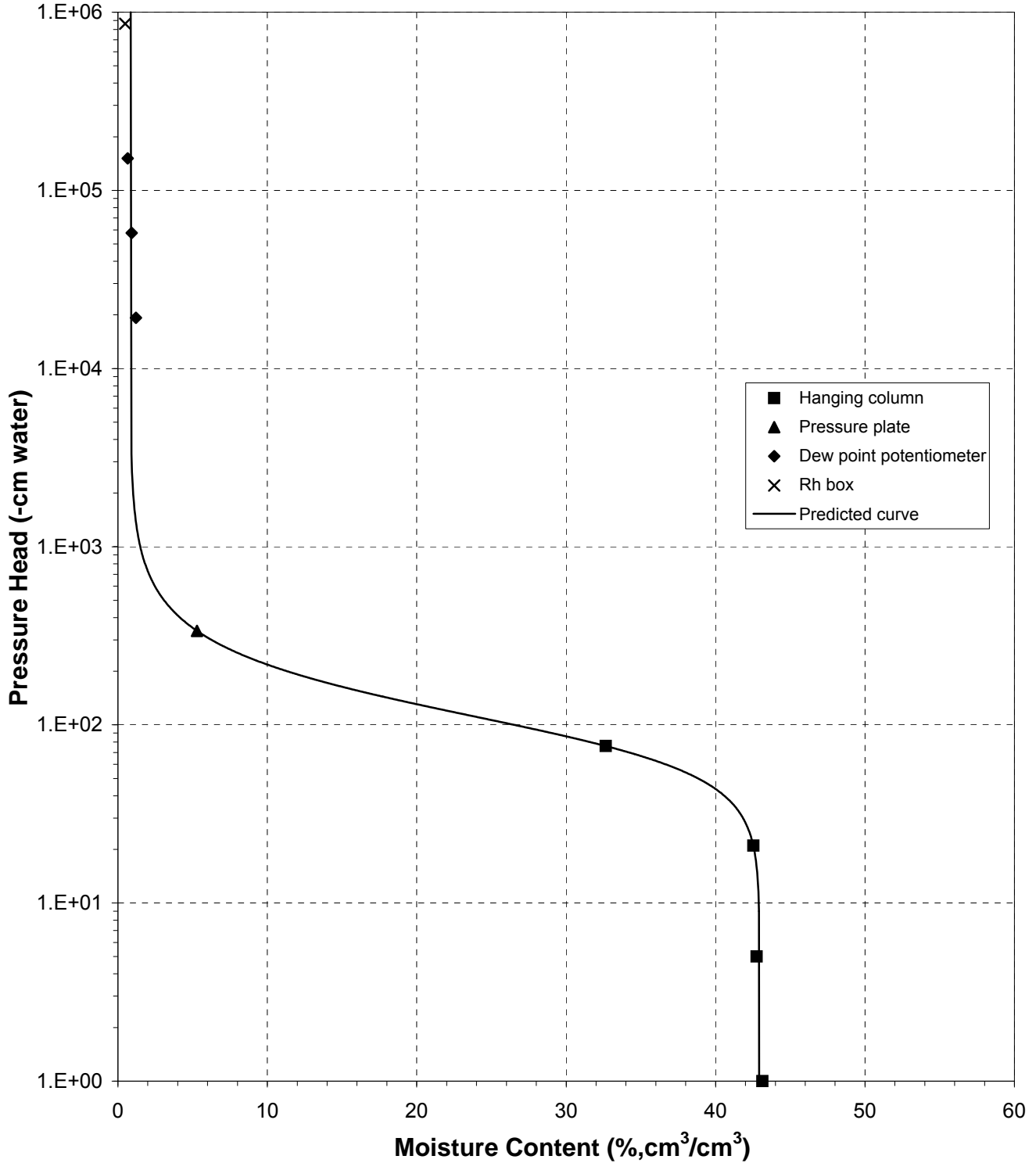



### Plot of Relative Hydraulic Conductivity vs Moisture Content

Sample Number: Blend 4 (44%)

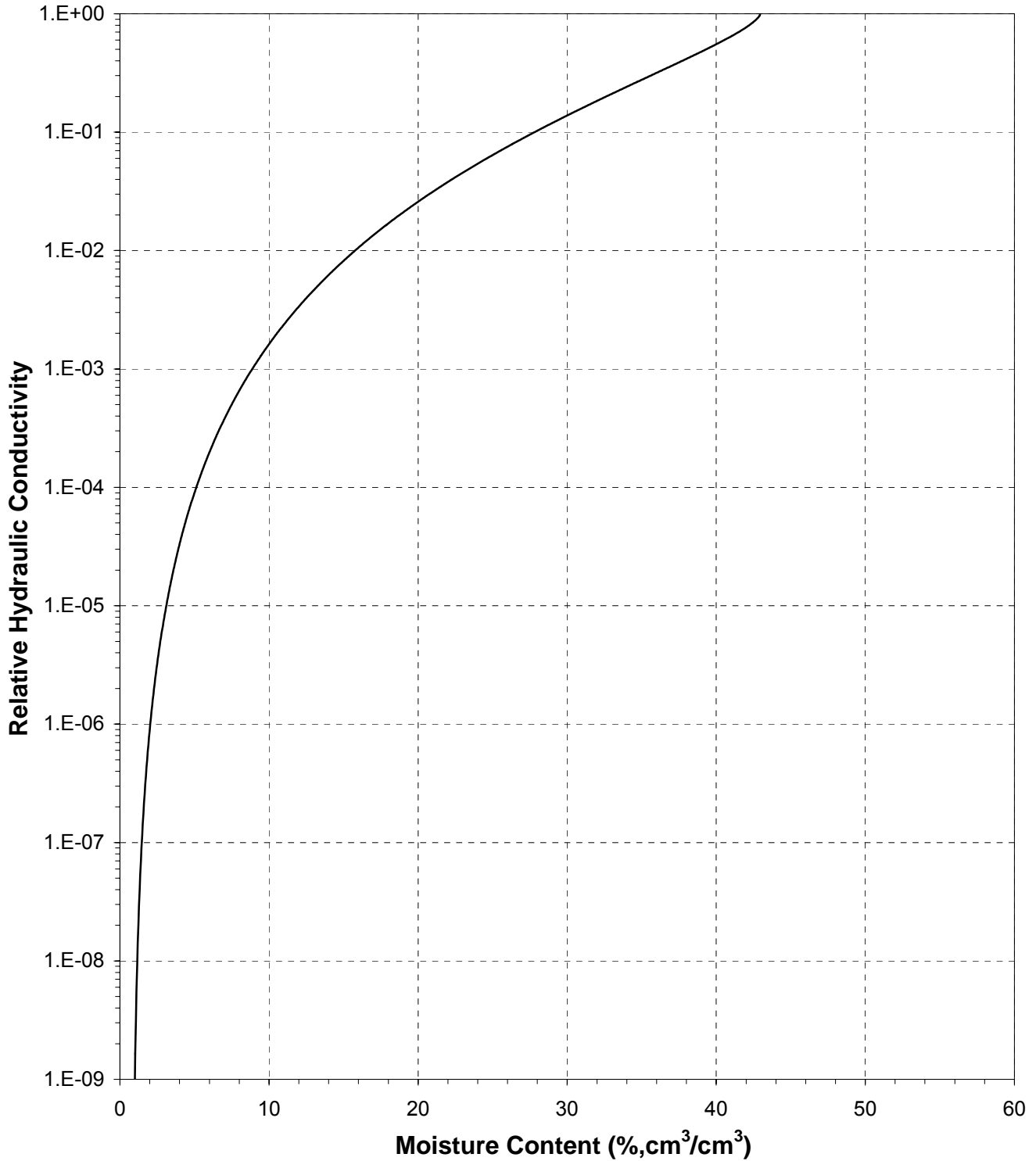



### Plot of Hydraulic Conductivity vs Moisture Content

Sample Number: Blend 4 (44%)

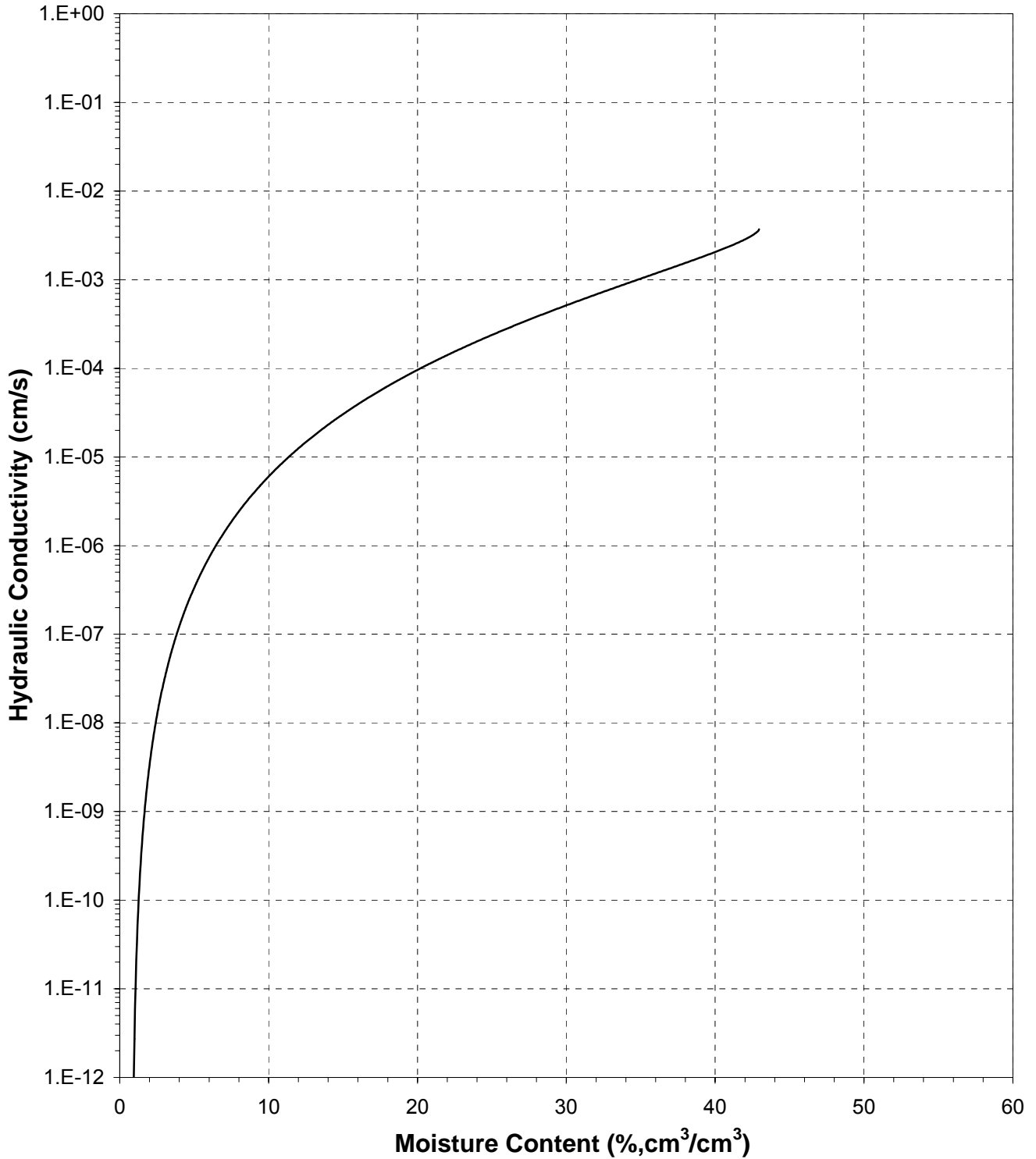



### Plot of Relative Hydraulic Conductivity vs Pressure Head

Sample Number: Blend 4 (44%)

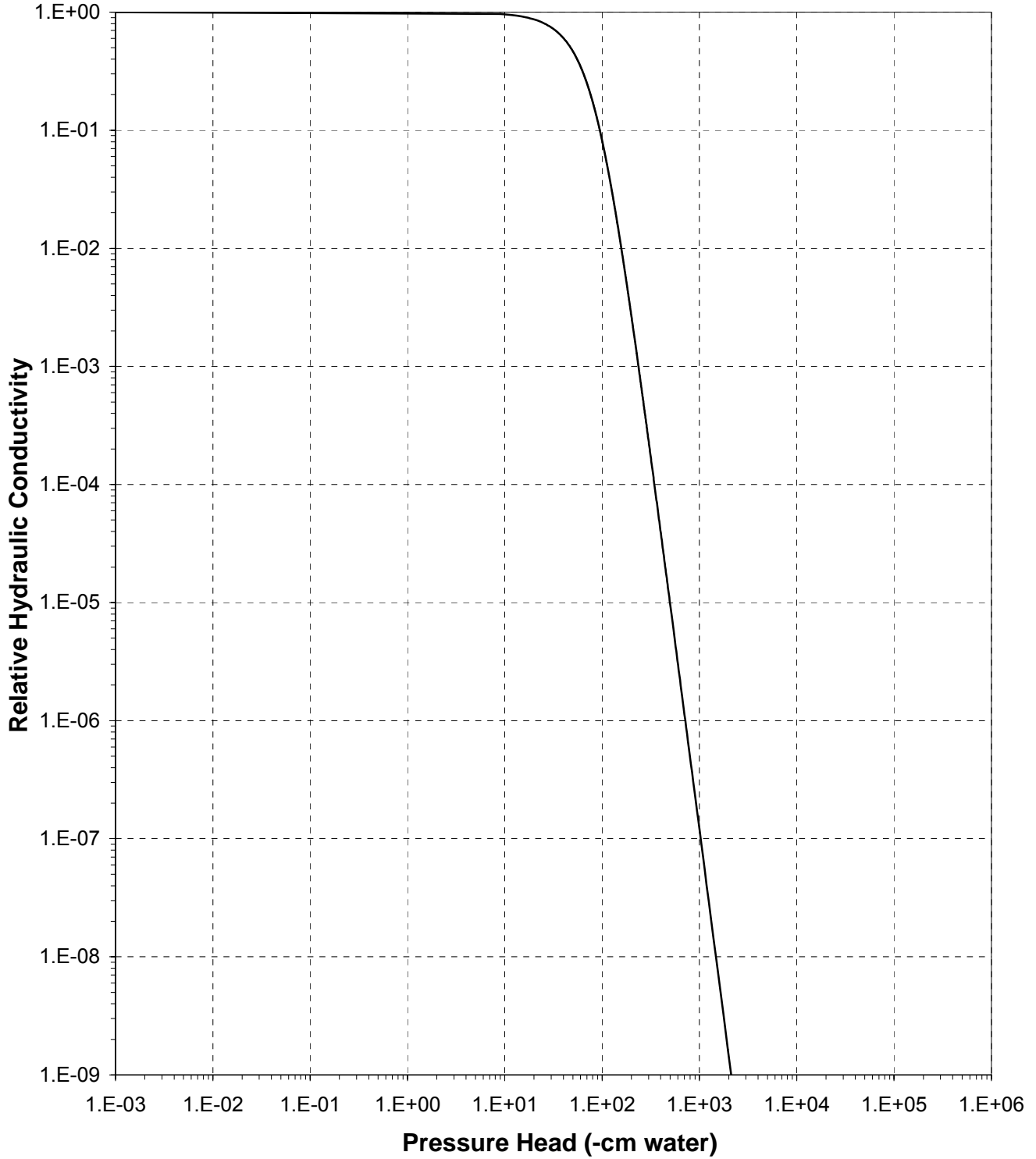



### Plot of Hydraulic Conductivity vs Pressure Head

Sample Number: Blend 4 (44%)

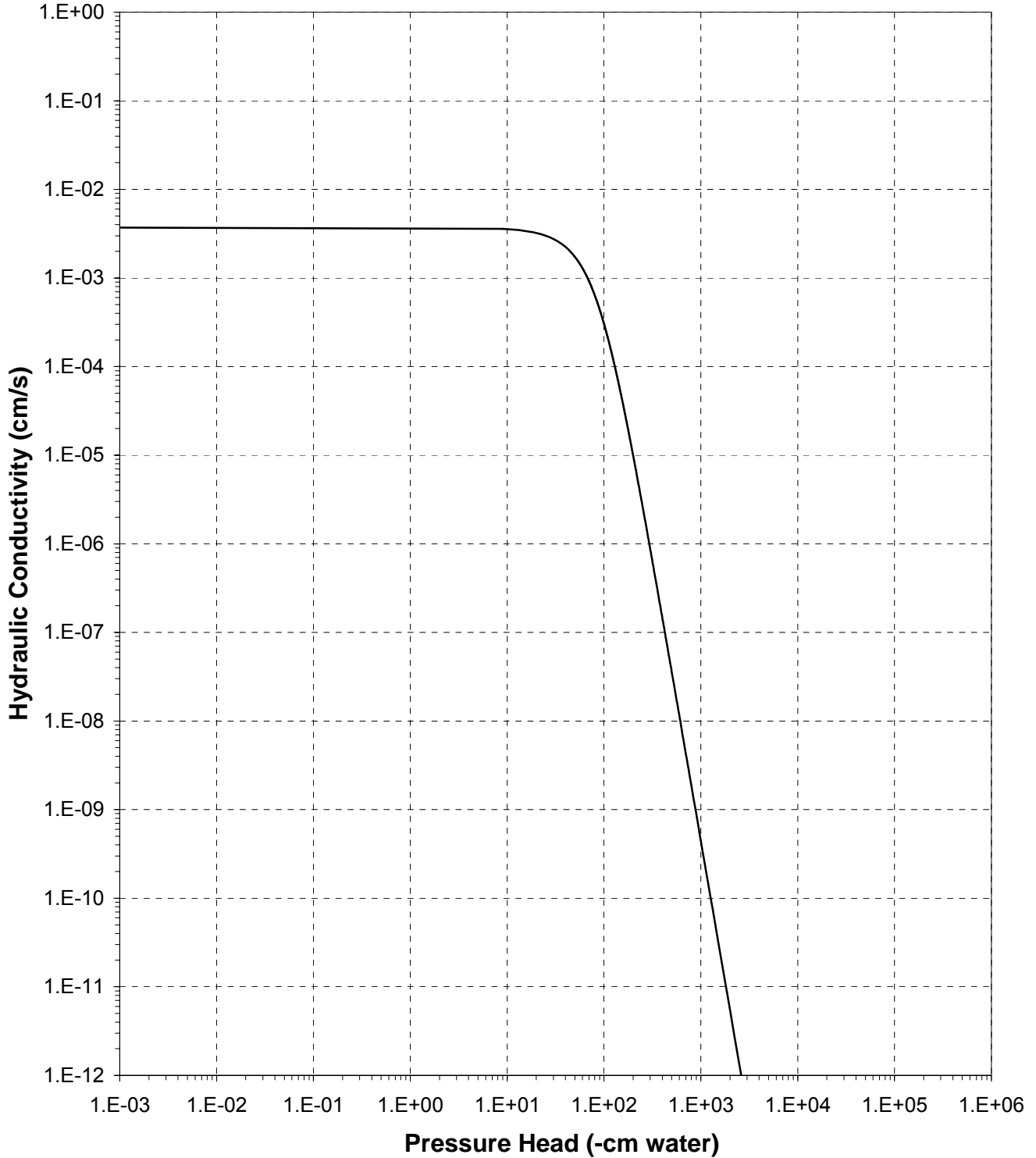





**Moisture Retention Data**  
**Hanging Column / Pressure Plate**  
 (Soil-Water Characteristic Curve)

Job Name: Barr Engineering Company  
 Job Number: LB10.0170.00  
 Sample Number: Blend 4 (50%)  
 Ring Number: NA  
 Depth: NA

Dry wt. of sample (g): 212.69  
 Tare wt., ring (g): 88.63  
 Tare wt., screen & clamp (g): 27.95  
 Initial sample volume (cm<sup>3</sup>): 143.72  
 Initial dry bulk density (g/cm<sup>3</sup>): 1.48  
 Measured particle density (g/cm<sup>3</sup>): 2.98  
 Initial calculated total porosity (%): 50.26

	Date	Time	Weight* (g)	Matric Potential (-cm water)	Moisture Content † (% vol)	
<i>Hanging column:</i>	13-Sep-10	15:50	387.27	0	42.23	##
	19-Sep-10	13:05	386.58	6.0	42.12	##
	26-Sep-10	11:05	385.28	30.0	41.37	##
	2-Oct-10	9:10	364.80	71.0	26.26	##
<i>Pressure plate:</i>	10-Oct-10	9:15	335.29	337	4.46	##

Volume Adjusted Data<sup>1</sup>

	Matric Potential (-cm water)	Adjusted Volume (cm <sup>3</sup> )	% Volume Change <sup>2</sup> (%)	Adjusted Density (g/cm <sup>3</sup> )	Adjusted Calculated Porosity (%)
<i>Hanging column:</i>	0.0	137.34	-4.44%	1.55	47.94
	6.0	136.07	-5.32%	1.56	47.46
	30.0	135.39	-5.80%	1.57	47.20
	71.0	135.29	-5.86%	1.57	47.16
<i>Pressure plate:</i>	337	134.92	-6.13%	1.58	47.01

**Comments:**

<sup>1</sup> Applicable if the sample experienced volume changes during testing. 'Volume Adjusted' values represent each of the volume change measurements obtained after saturated hydraulic conductivity testing and throughout hanging column/pressure plate testing. "---" indicates no volume changes occurred.

<sup>2</sup> Represents percent volume change from original sample volume. A '+' denotes measured sample swelling, a '-' denotes measured sample settling, and '---' denotes no volume change occurred.

\* Weight including tares

† Assumed density of water is 1.0 g/cm<sup>3</sup>

## Volume adjustments are applicable at this matric potential (see comment #1).

**Technician Notes:**

*Laboratory analysis by:* K. Wright  
*Data entered by:* K. Wright  
*Checked by:* J. Hines



**Moisture Retention Data**  
**Dew Point Potentiometer / Relative Humidity Box**  
 (Soil-Water Characteristic Curve)

Sample Number: Blend 4 (50%)

Initial sample bulk density (g/cm<sup>3</sup>): 1.48  
 Fraction of bulk sample used (<2.00mm fraction) (%): 100.00

Dry weight\* of dew point potentiometer sample (g): 164.74  
 Tare weight, jar (g): 113.21

	Date	Time	Weight* (g)	Water Potential (-cm water)	Moisture Content <sup>†</sup> (% vol)	
Dew point potentiometer:	21-Oct-10	9:24	165.16	16929	1.44	##
	21-Oct-10	8:42	165.04	46197	1.03	##
	21-Oct-10	11:35	164.96	265658	0.76	##

Volume Adjusted Data<sup>1</sup>

	Water Potential (-cm water)	Adjusted Volume (cm <sup>3</sup> )	% Volume Change <sup>2</sup> (%)	Adjusted Density (g/cm <sup>3</sup> )	Adjusted Calc. Porosity (%)
Dew point potentiometer:	16929	120.23	-16.34%	1.77	40.54
	46197	120.23	-16.34%	1.77	40.54
	265658	120.23	-16.34%	1.77	40.54

Dry weight\* of relative humidity box sample (g): 72.51  
 Tare weight (g): 41.63

	Date	Time	Weight* (g)	Water Potential (-cm water)	Moisture Content <sup>†</sup> (% vol)	
Relative humidity box:	16-Sep-10	11:05	72.58	861325	0.38	##

Volume Adjusted Data<sup>1</sup>

	Water Potential (-cm water)	Adjusted Volume (cm <sup>3</sup> )	% Volume Change <sup>2</sup> (%)	Adjusted Density (g/cm <sup>3</sup> )	Adjusted Calc. Porosity (%)
Relative humidity box:	861325	134.92	-6.13%	1.58	47.01

**Comments:**

<sup>1</sup> Applicable if the sample experienced volume changes during testing. 'Volume Adjusted' values represent the volume change measurements obtained after the last hanging column or pressure plate point. "---" indicates no volume changes occurred.

<sup>2</sup> Represents percent volume change from original sample volume. A '+' denotes measured sample swelling, a '-' denotes measured sample settling, and '--' denotes no volume change occurred.

\* Weight including tares

<sup>†</sup> Adjusted for >2.00mm (#10 sieve) material not used in DPP/RH testing. Assumed moisture content of material >2.00mm is zero, and assumed density of water is 1.0 g/cm<sup>3</sup>.

## Volume adjustments are applicable at this matric potential (see comment #1).

Laboratory analysis by: K. Wright/M. Vigil  
 Data entered by: K. Wright  
 Checked by: J. Hines



### Water Retention Data Points

Sample Number: Blend 4 (50%)

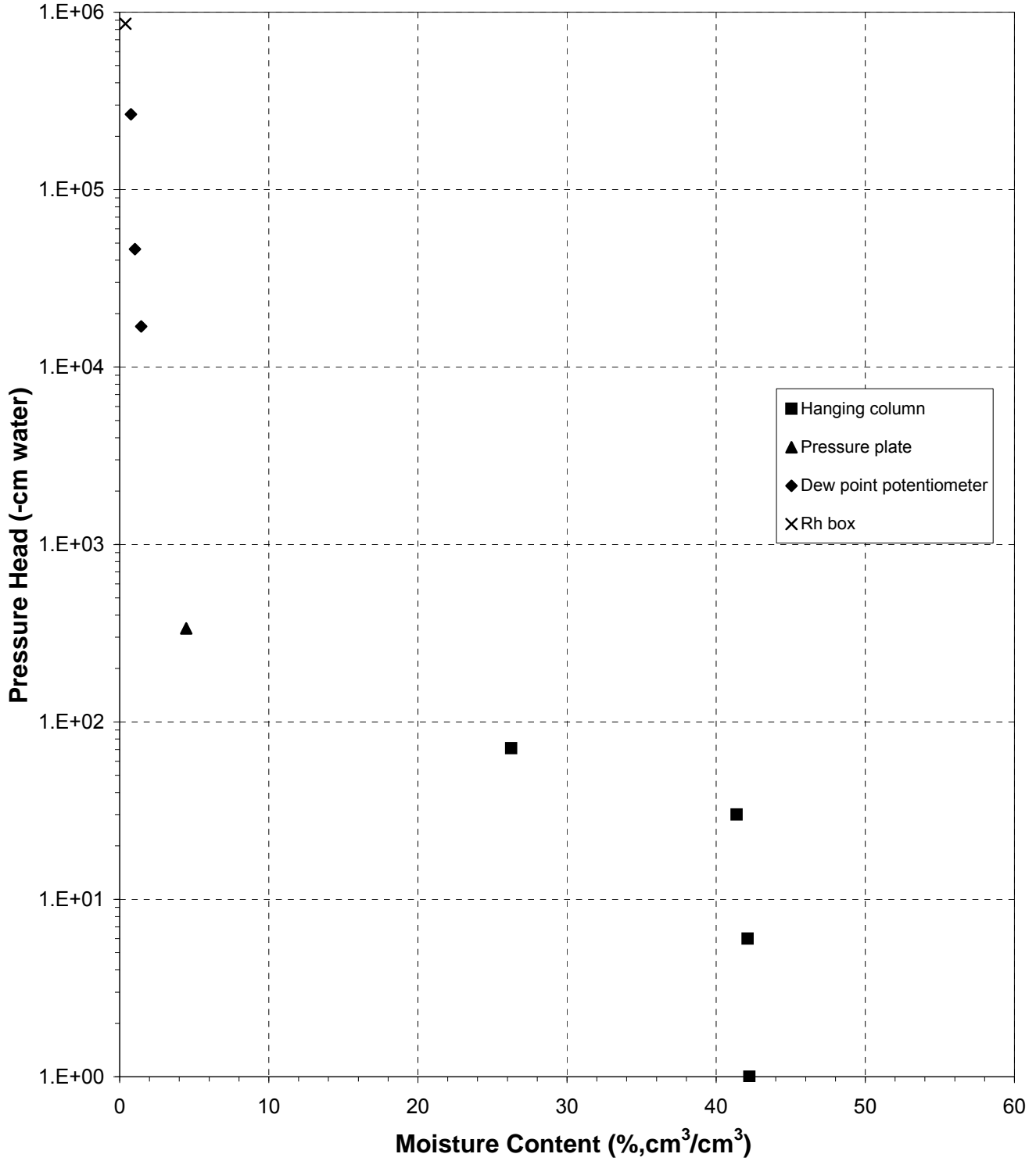



### Predicted Water Retention Curve and Data Points

Sample Number: Blend 4 (50%)

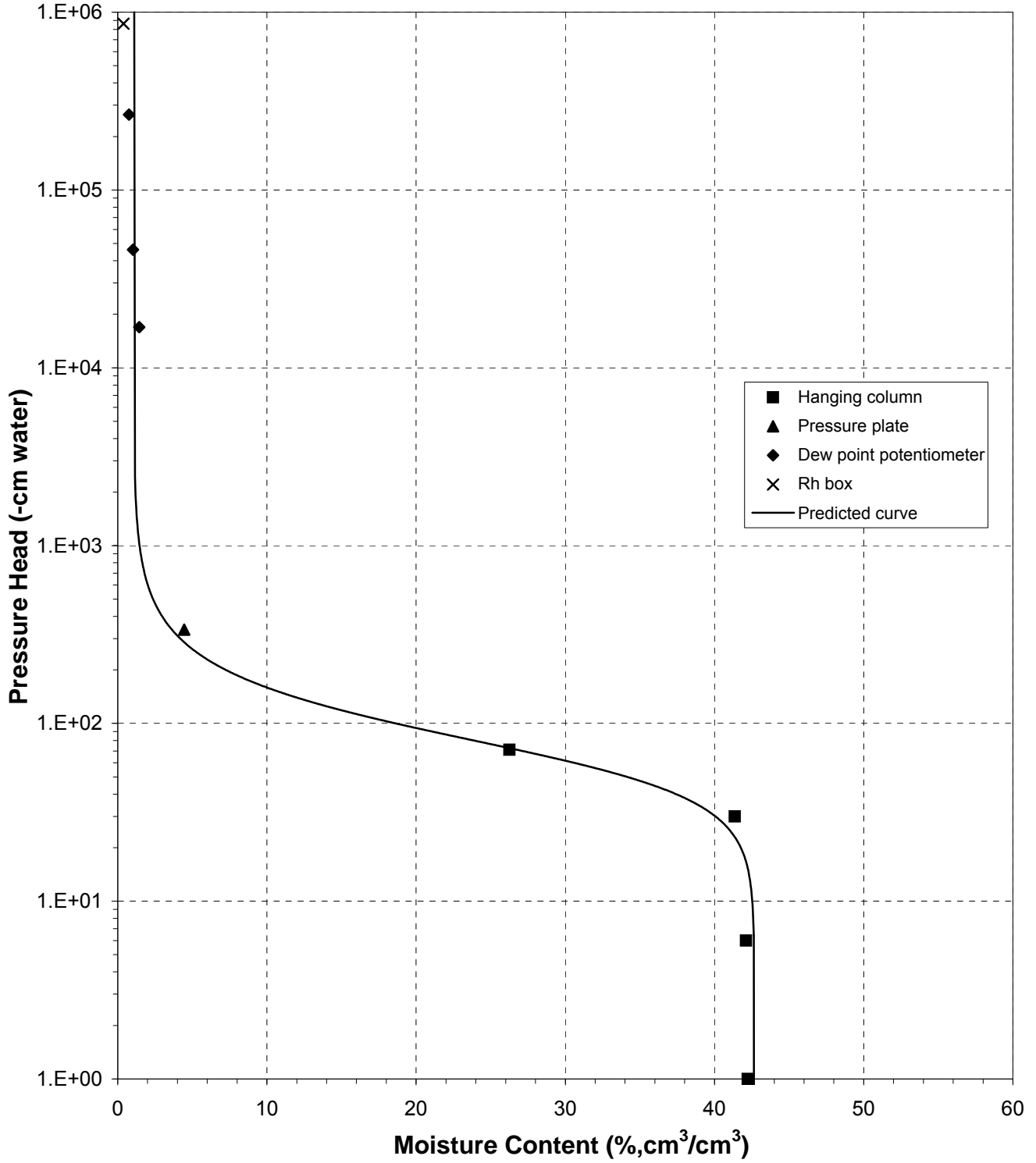



### Plot of Relative Hydraulic Conductivity vs Moisture Content

Sample Number: Blend 4 (50%)

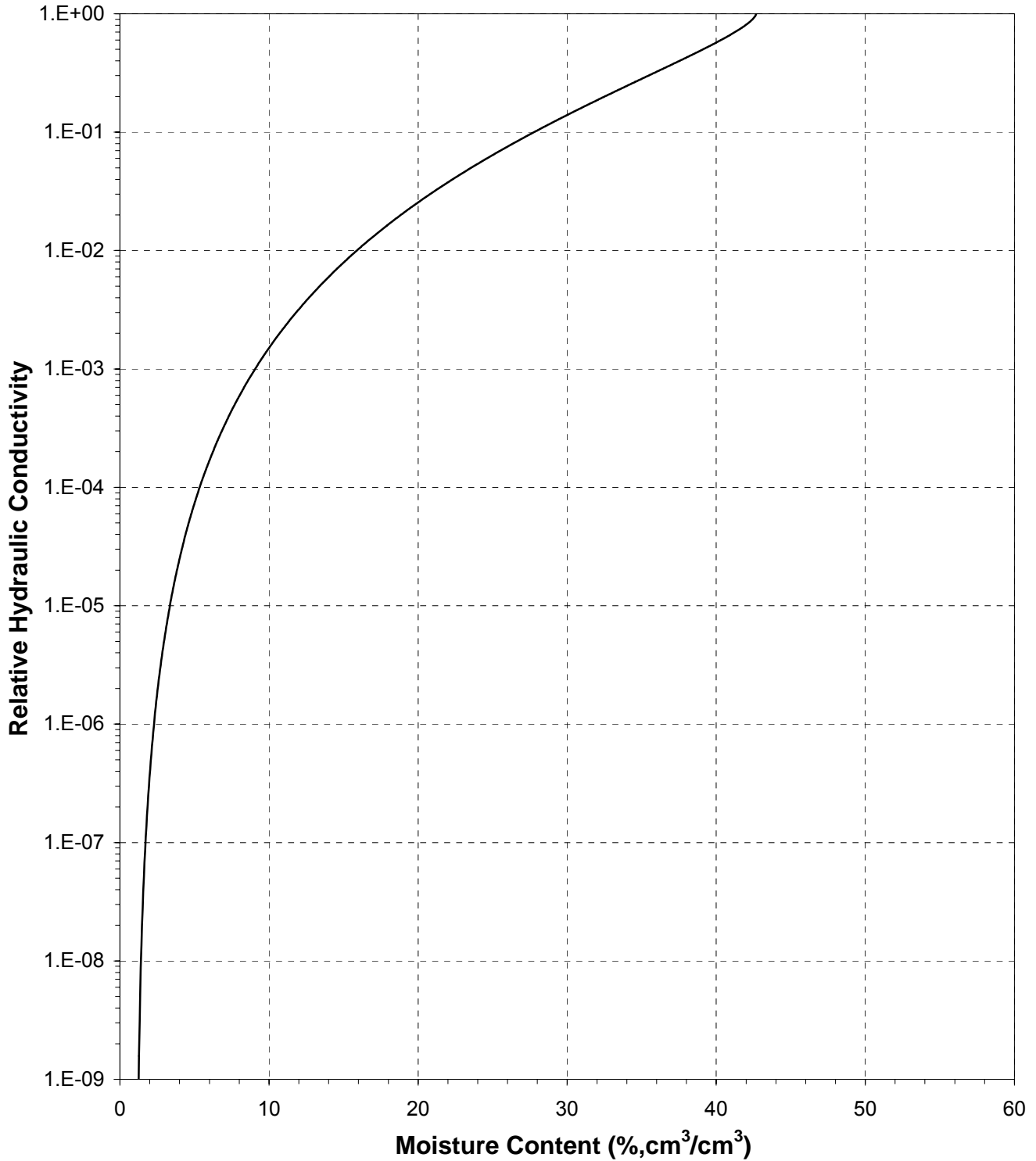



### Plot of Hydraulic Conductivity vs Moisture Content

Sample Number: Blend 4 (50%)

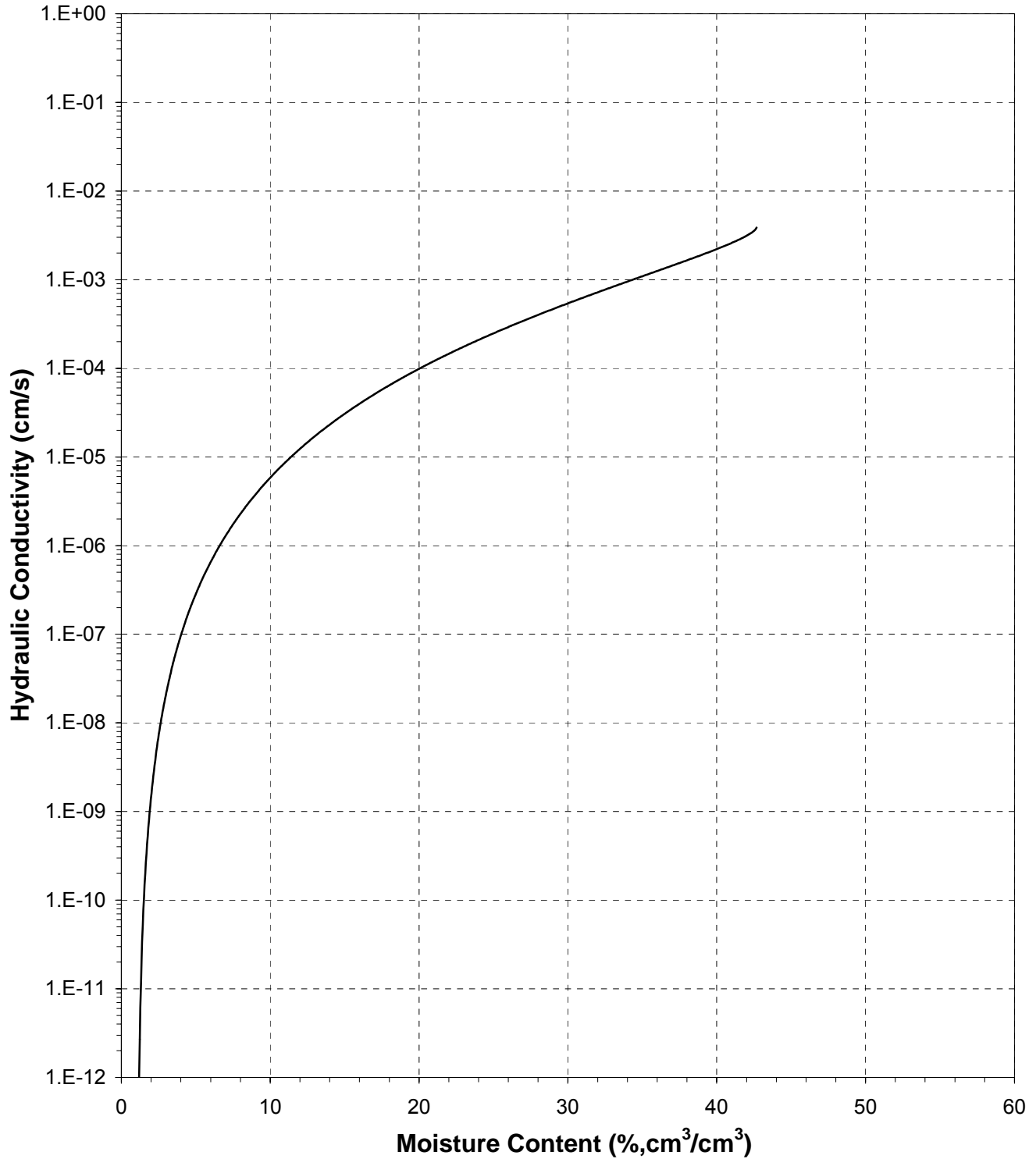



### Plot of Relative Hydraulic Conductivity vs Pressure Head

Sample Number: Blend 4 (50%)

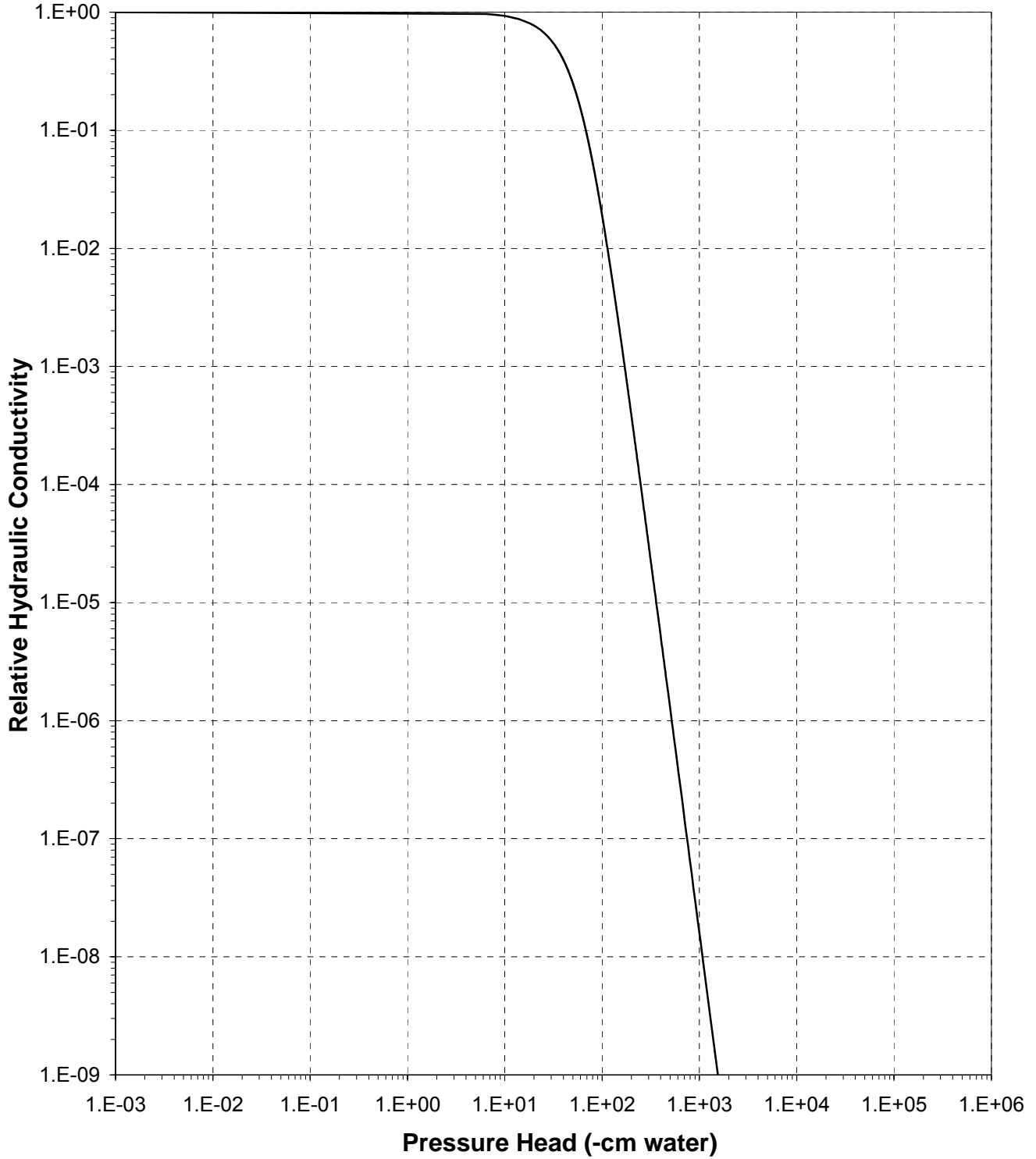



### Plot of Hydraulic Conductivity vs Pressure Head

Sample Number: Blend 4 (50%)

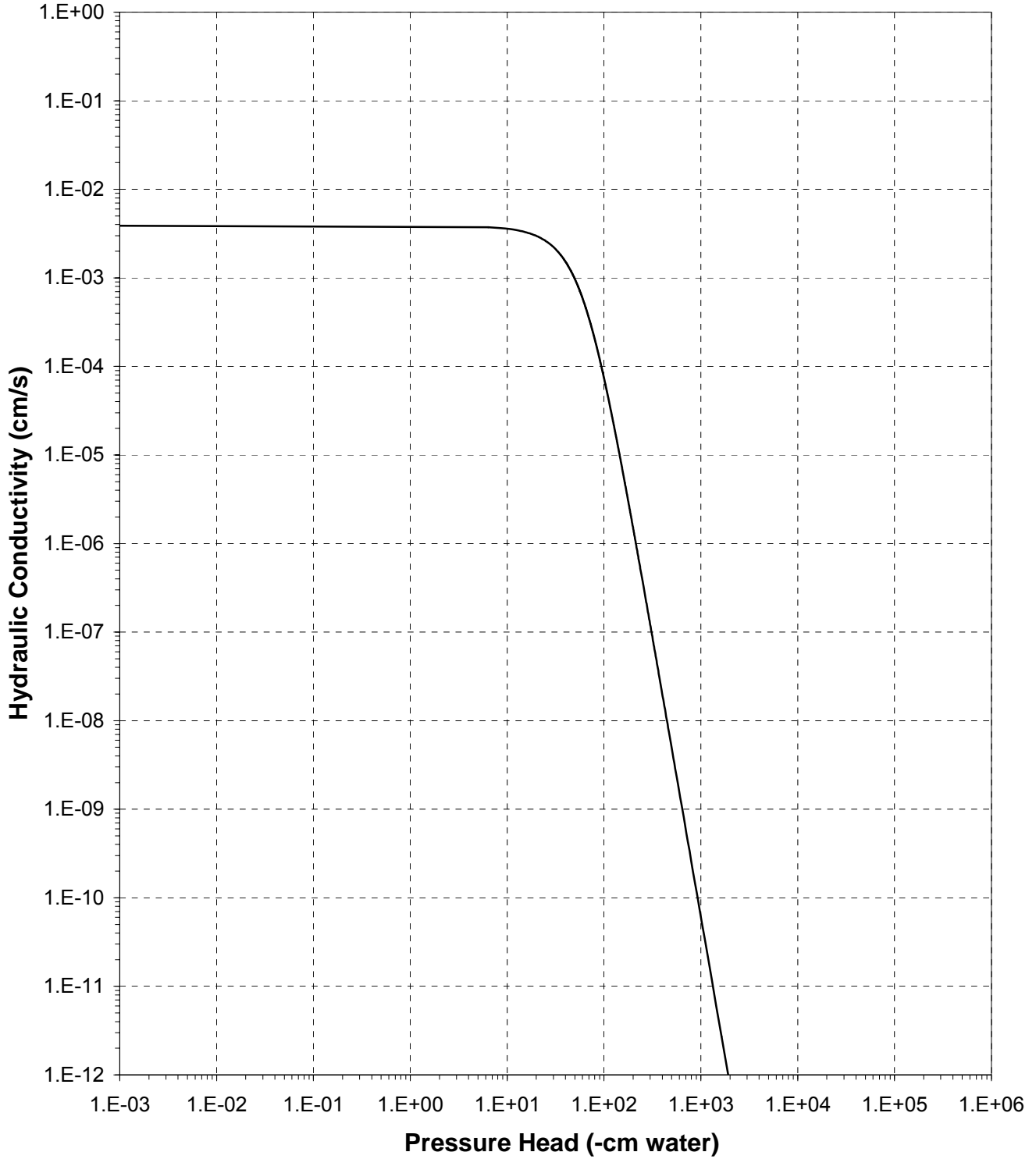





**Moisture Retention Data**  
**Hanging Column / Pressure Plate**  
 (Soil-Water Characteristic Curve)

Job Name: Barr Engineering Company  
 Job Number: LB10.0170.00  
 Sample Number: Blend 4 (55%)  
 Ring Number: NA  
 Depth: NA

Dry wt. of sample (g): 192.87  
 Tare wt., ring (g): 88.93  
 Tare wt., screen & clamp (g): 29.07  
 Initial sample volume (cm<sup>3</sup>): 144.26  
 Initial dry bulk density (g/cm<sup>3</sup>): 1.34  
 Measured particle density (g/cm<sup>3</sup>): 2.98  
 Initial calculated total porosity (%): 55.06

	Date	Time	Weight* (g)	Matric Potential (-cm water)	Moisture Content † (% vol)	
<i>Hanging column:</i>	13-Sep-10	15:45	363.11	0	41.60	##
	19-Sep-10	13:10	360.86	6.0	40.74	##
	26-Sep-10	11:15	359.62	30.0	39.78	##
	2-Oct-10	9:15	346.67	71.0	29.27	##
<i>Pressure plate:</i>	10-Oct-10	9:15	316.60	337	4.74	##

Volume Adjusted Data<sup>1</sup>

	Matric Potential (-cm water)	Adjusted Volume (cm <sup>3</sup> )	% Volume Change <sup>2</sup> (%)	Adjusted Density (g/cm <sup>3</sup> )	Adjusted Calculated Porosity (%)
<i>Hanging column:</i>	0.0	125.57	-12.95%	1.54	48.37
	6.0	122.72	-14.93%	1.57	47.17
	30.0	122.55	-15.05%	1.57	47.10
	71.0	122.32	-15.21%	1.58	47.00
<i>Pressure plate:</i>	337	120.92	-16.18%	1.60	46.39

**Comments:**

<sup>1</sup> Applicable if the sample experienced volume changes during testing. 'Volume Adjusted' values represent each of the volume change measurements obtained after saturated hydraulic conductivity testing and throughout hanging column/pressure plate testing. "---" indicates no volume changes occurred.

<sup>2</sup> Represents percent volume change from original sample volume. A '+' denotes measured sample swelling, a '-' denotes measured sample settling, and '---' denotes no volume change occurred.

\* Weight including tares

† Assumed density of water is 1.0 g/cm<sup>3</sup>

## Volume adjustments are applicable at this matric potential (see comment #1).

**Technician Notes:**

*Laboratory analysis by:* K. Wright  
*Data entered by:* K. Wright  
*Checked by:* J. Hines



**Moisture Retention Data**  
**Dew Point Potentiometer / Relative Humidity Box**  
 (Soil-Water Characteristic Curve)

Sample Number: Blend 4 (55%)

Initial sample bulk density (g/cm<sup>3</sup>): 1.34  
 Fraction of bulk sample used (<2.00mm fraction) (%): 100.00

Dry weight\* of dew point potentiometer sample (g): 152.16  
 Tare weight, jar (g): 117.16

	Date	Time	Weight* (g)	Water Potential (-cm water)	Moisture Content <sup>†</sup> (% vol)	
Dew point potentiometer:	19-Oct-10	13:04	152.58	6323	2.00	##
	20-Oct-10	9:20	152.29	66695	0.62	##
	20-Oct-10	13:05	152.31	105345	0.72	##

Volume Adjusted Data<sup>1</sup>

	Water Potential (-cm water)	Adjusted Volume (cm <sup>3</sup> )	% Volume Change <sup>2</sup> (%)	Adjusted Density (g/cm <sup>3</sup> )	Adjusted Calc. Porosity (%)
Dew point potentiometer:	6323	114.77	-20.44%	1.68	43.52
	66695	114.77	-20.44%	1.68	43.52
	105345	114.77	-20.44%	1.68	43.52

Dry weight\* of relative humidity box sample (g): 73.55  
 Tare weight (g): 42.30

	Date	Time	Weight* (g)	Water Potential (-cm water)	Moisture Content <sup>†</sup> (% vol)	
Relative humidity box:	16-Sep-10	11:05	73.64	861325	0.45	##

Volume Adjusted Data<sup>1</sup>

	Water Potential (-cm water)	Adjusted Volume (cm <sup>3</sup> )	% Volume Change <sup>2</sup> (%)	Adjusted Density (g/cm <sup>3</sup> )	Adjusted Calc. Porosity (%)
Relative humidity box:	861325	120.92	-16.18%	1.60	46.39

**Comments:**

<sup>1</sup> Applicable if the sample experienced volume changes during testing. 'Volume Adjusted' values represent the volume change measurements obtained after the last hanging column or pressure plate point. "----" indicates no volume changes occurred.

<sup>2</sup> Represents percent volume change from original sample volume. A '+' denotes measured sample swelling, a '-' denotes measured sample settling, and '---' denotes no volume change occurred.

\* Weight including tares

<sup>†</sup> Adjusted for >2.00mm (#10 sieve) material not used in DPP/RH testing. Assumed moisture content of material >2.00mm is zero, and assumed density of water is 1.0 g/cm<sup>3</sup>.

## Volume adjustments are applicable at this matric potential (see comment #1).

Laboratory analysis by: K. Wright/M. Vigil  
 Data entered by: K. Wright  
 Checked by: J. Hines



### Water Retention Data Points

Sample Number: Blend 4 (55%)

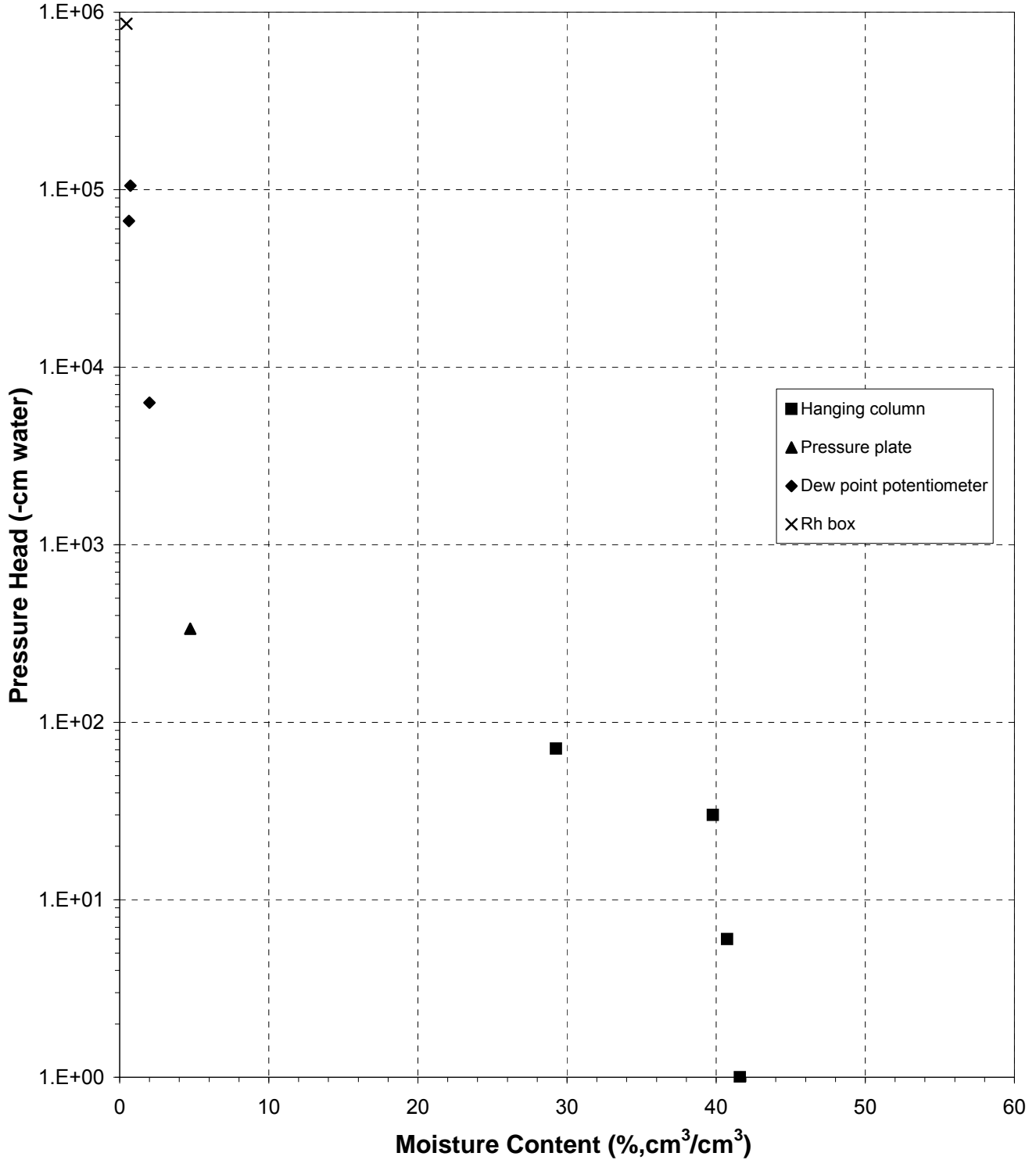



### Predicted Water Retention Curve and Data Points

Sample Number: Blend 4 (55%)

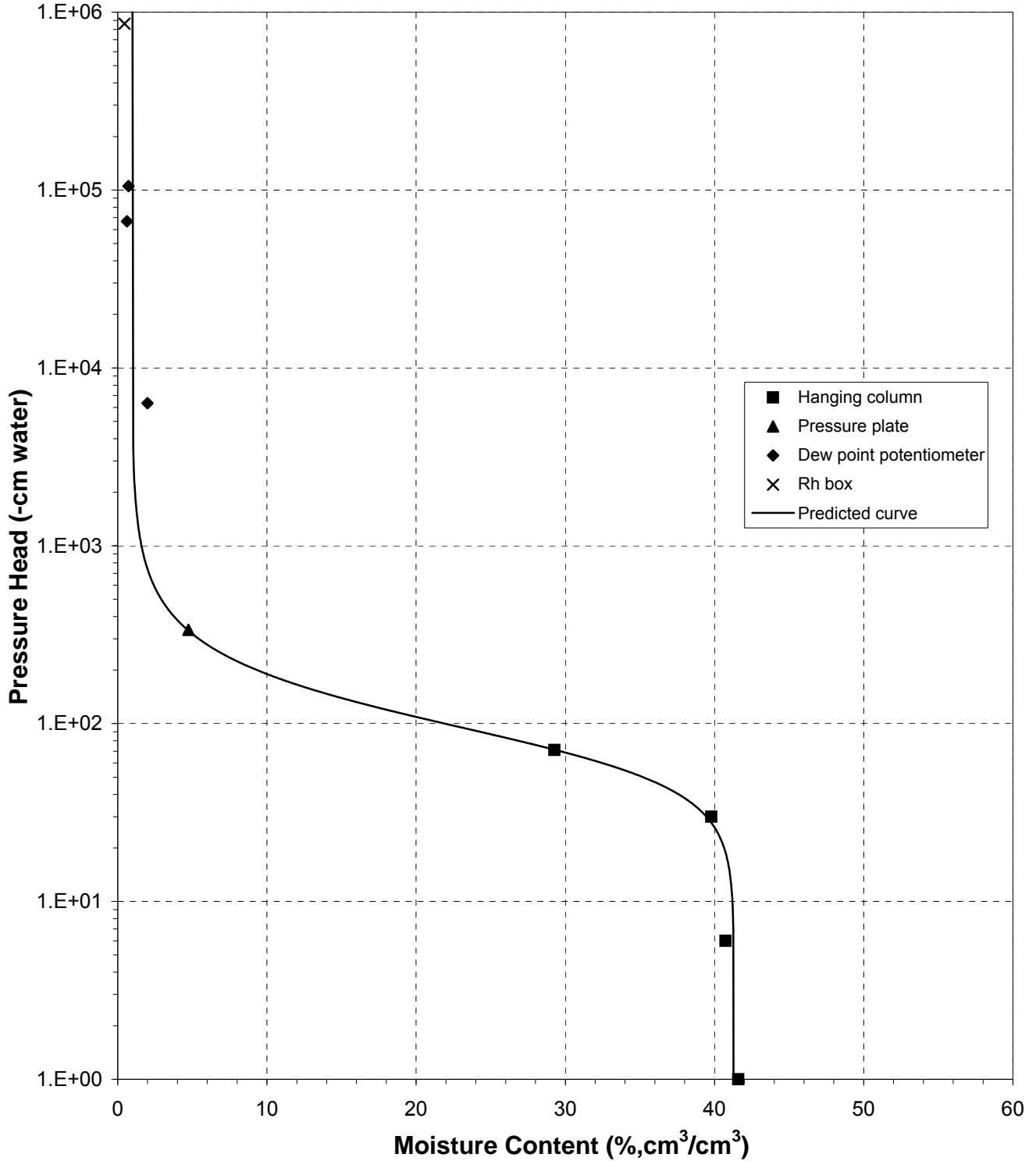



### Plot of Relative Hydraulic Conductivity vs Moisture Content

Sample Number: Blend 4 (55%)

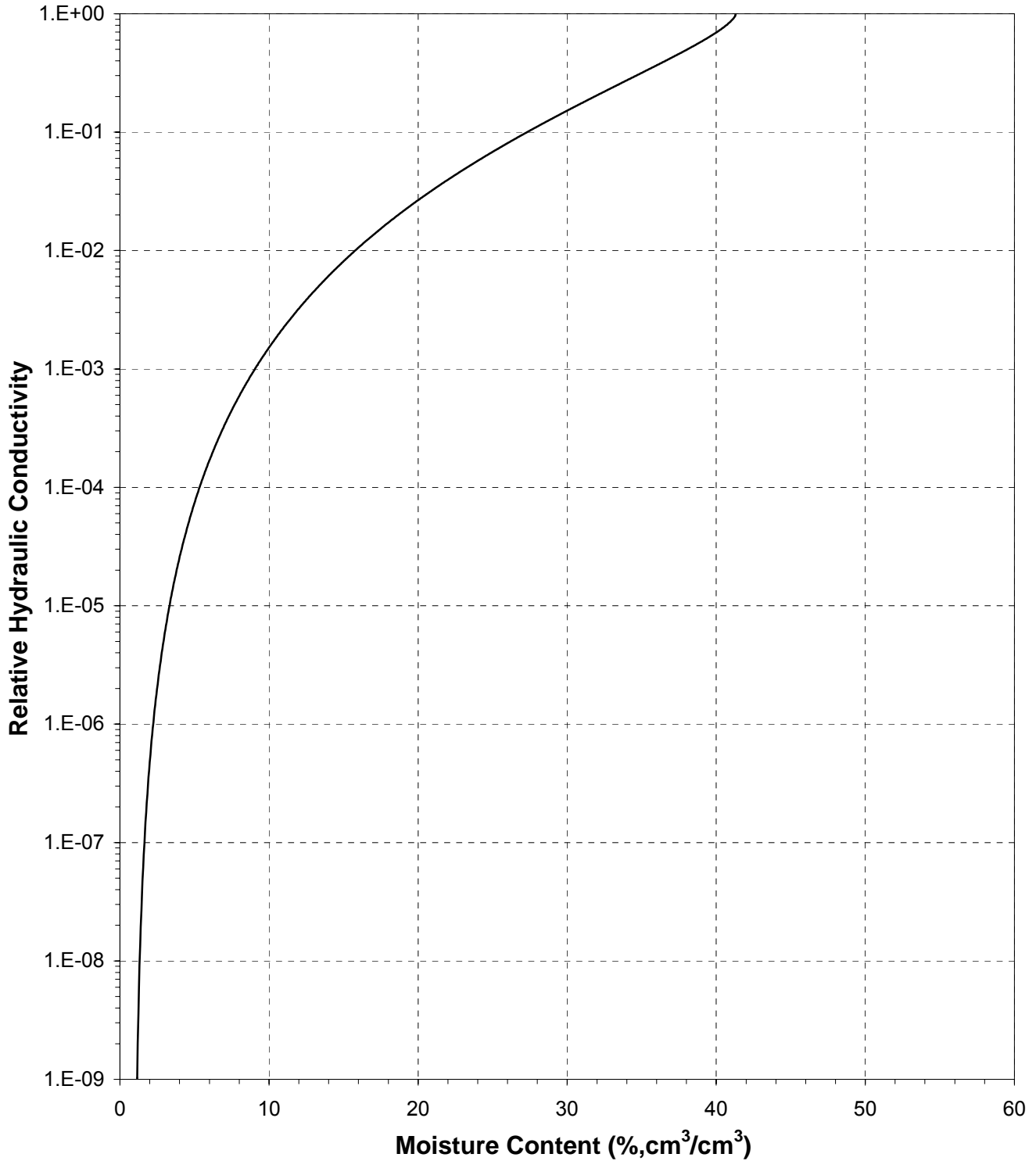



### Plot of Hydraulic Conductivity vs Moisture Content

Sample Number: Blend 4 (55%)

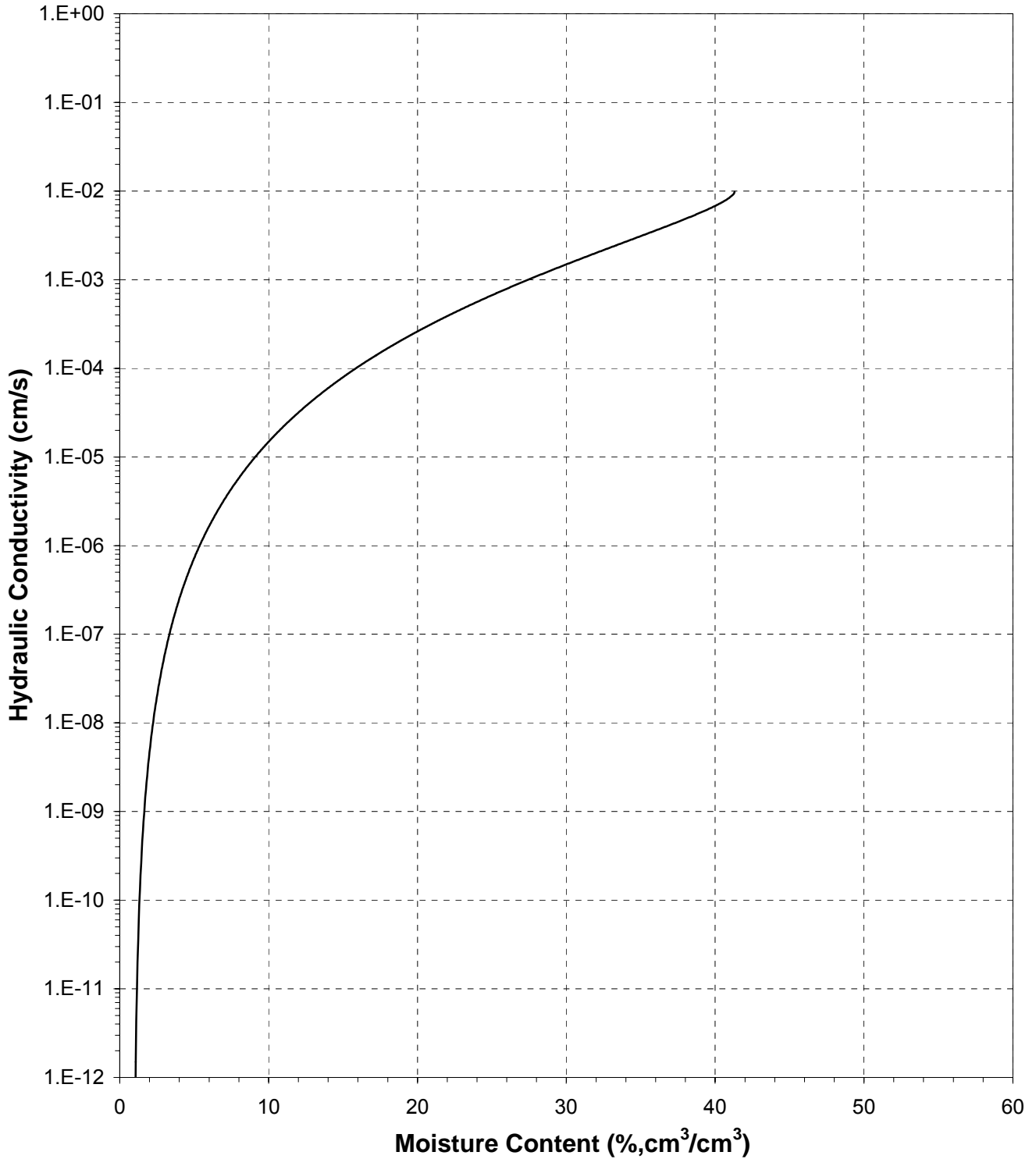



### Plot of Relative Hydraulic Conductivity vs Pressure Head

Sample Number: Blend 4 (55%)

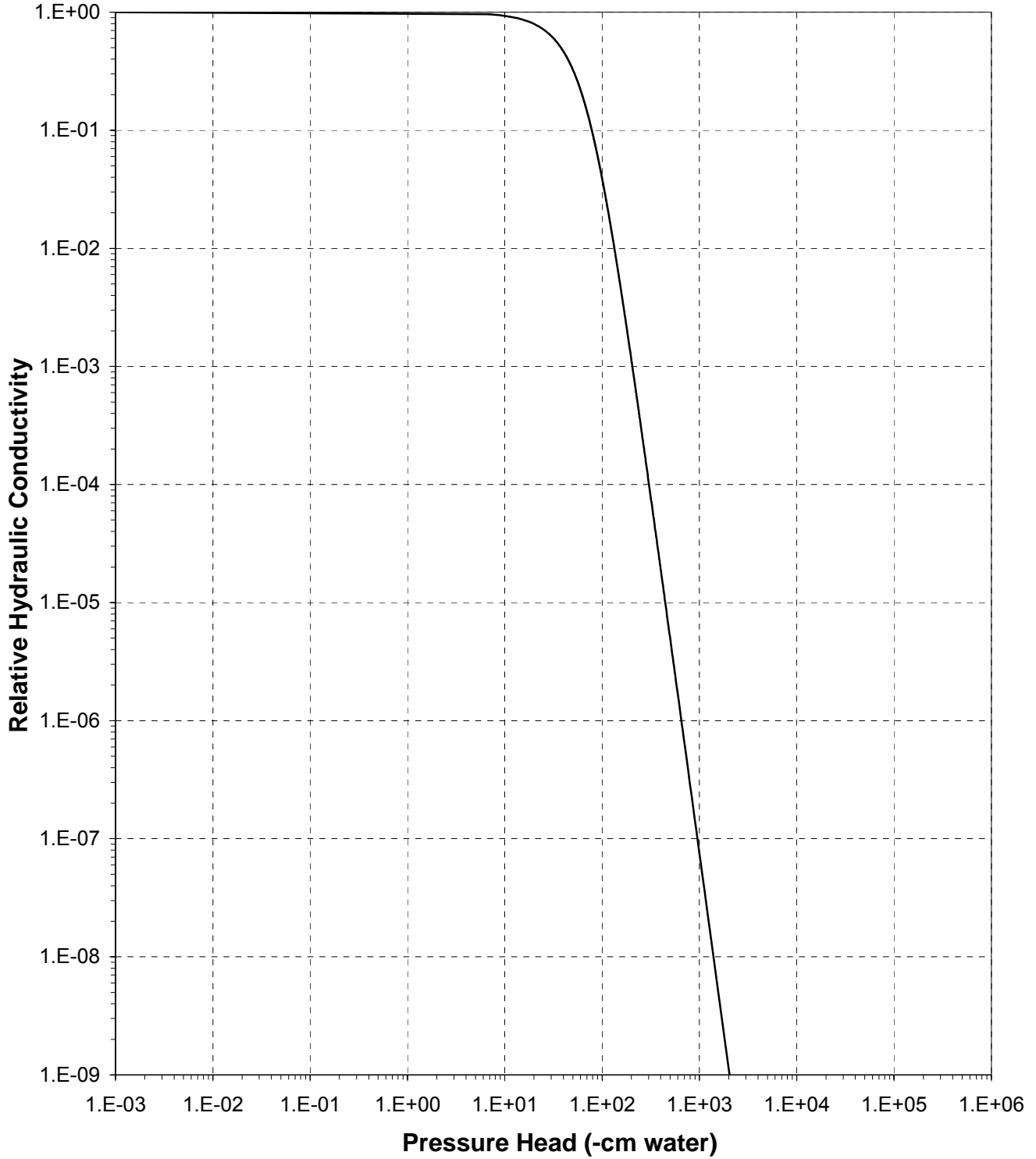



### Plot of Hydraulic Conductivity vs Pressure Head

Sample Number: Blend 4 (55%)

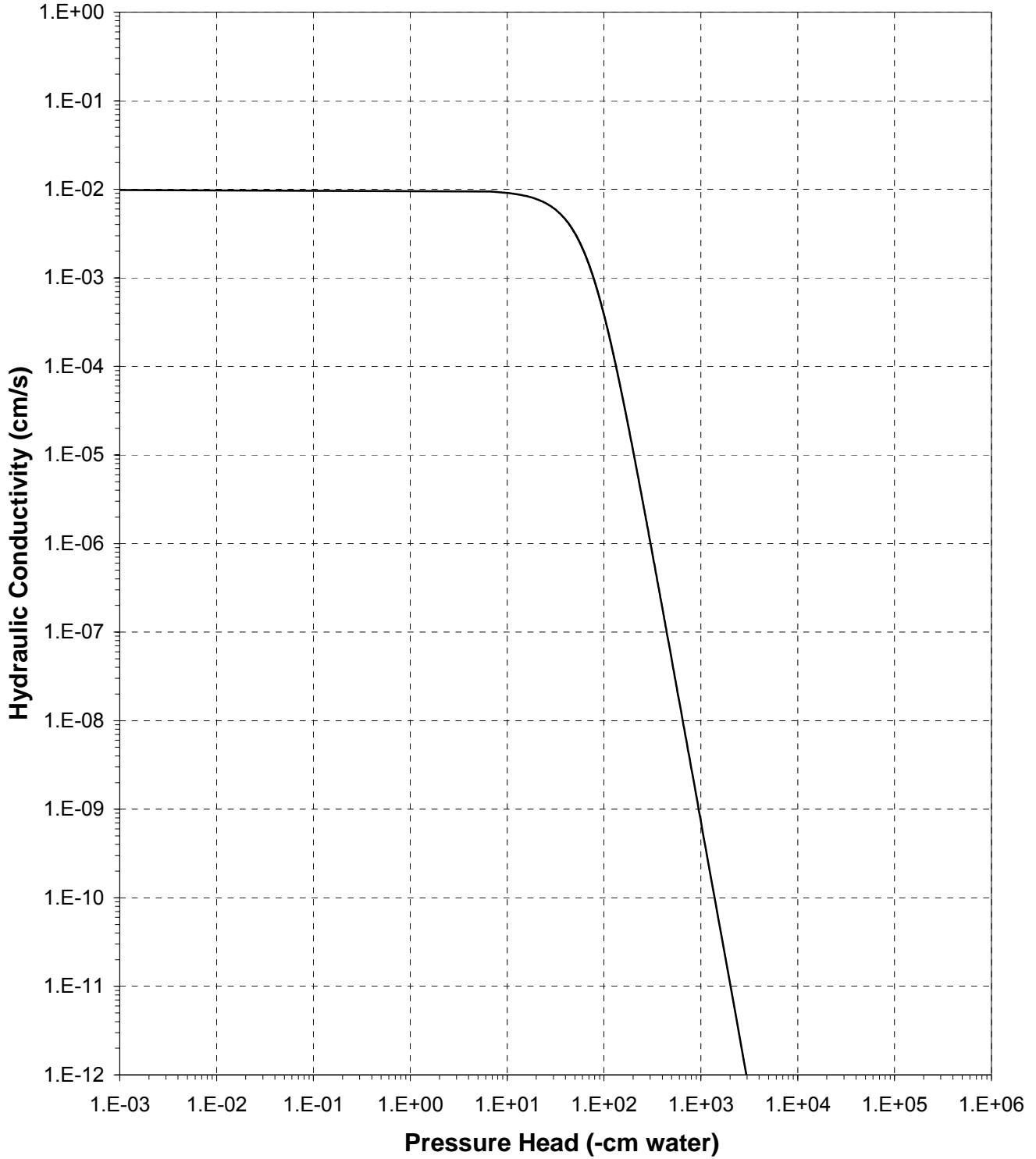



# Particle Size Analysis



### Summary of Particle Size Characteristics

Sample Number	d <sub>10</sub> (mm)	d <sub>50</sub> (mm)	d <sub>60</sub> (mm)	C <sub>u</sub>	C <sub>c</sub>	Method	ASTM Classification	USDA Classification
As Received	0.010	0.076	0.096	9.6	2.1	WS/H	Silty sand (SM)	Sandy Loam
Blend 1	0.0037	0.037	0.048	13	1.6	WS/H	Silt with sand (ML)s	Silt Loam
Blend 2	0.0056	0.062	0.082	15	2.2	WS/H	Sandy silt s(ML)	Sandy Loam
Blend 3	0.013	0.092	0.11	8.5	2.4	WS/H	Silty sand (SM)	Loamy Sand
Blend 4	0.051	0.11	0.14	2.7	1.0	WS/H	Silty sand (SM)	Sand

d<sub>50</sub> = Median particle diameter

Est = Reported values for d<sub>10</sub>, C<sub>u</sub>, C<sub>c</sub>, and soil classification are estimates, since extrapolation was required to obtain the d<sub>10</sub> diameter

$$C_u = \frac{d_{60}}{d_{10}}$$

$$C_c = \frac{(d_{30})^2}{(d_{10})(d_{60})}$$

DS = Dry sieve

H = Hydrometer

WS = Wet sieve

† Greater than 10% of sample is coarse material



**Percent Gravel, Sand, Silt and Clay\***

Sample Number	% Gravel (>4.75mm)	% Sand (<4.75mm, >0.075mm)	% Silt (<0.075mm, >0.002mm)	% Clay (<0.002mm)
As Received	0.0	50.3	43.8	5.9
Blend 1	0.0	22.9	70.0	7.1
Blend 2	0.0	43.5	51.1	5.4
Blend 3	0.0	62.6	34.0	3.4
Blend 4	0.0	78.6	19.3	2.1

\*USCS classification does not classify clay fraction based on particle size. USDA definition of clay (<0.002mm) used in this table.



**Particle Size Analysis  
Wet Sieve Data (#10 Split)**

Job Name: Barr Engineering Company  
 Job Number: LB10.0170.00  
 Sample Number: As Received  
 Ring Number: NA  
 Depth: NA  
 Test Date: 22-Aug-10

Initial Dry Weight of Sample (g): 494.56  
 Weight Passing #10 (g): 494.56  
 Weight Retained #10 (g): 0.00  
 Weight of Hydrometer Sample (g): 46.39  
 Calculated Weight of Sieve Sample (g): 46.39  
 Shape: Angular  
 Hardness: Soft

Test Fraction	Sieve Number	Diameter (mm)	Wt. Retained	Cum Wt. Retained	Wt. Passing	% Passing
+10	3"	75	0.00	0.00	494.56	100.00
	2"	50	0.00	0.00	494.56	100.00
	1.5"	38.1	0.00	0.00	494.56	100.00
	1"	25	0.00	0.00	494.56	100.00
	3/4"	19.0	0.00	0.00	494.56	100.00
	3/8"	9.5	0.00	0.00	494.56	100.00
	4	4.75	0.00	0.00	494.56	100.00
	10	2.00	0.00	0.00	494.56	100.00
-10	(Based on calculated sieve wt.)					
	20	0.85	0.02	0.02	46.37	99.96
	40	0.425	0.08	0.10	46.29	99.78
	60	0.250	1.28	1.38	45.01	97.03
	140	0.106	15.37	16.75	29.64	63.89
	200	0.075	6.59	23.34	23.05	49.69
	dry pan			0.89	24.23	22.16
wet pan				22.16	0.00	

d<sub>10</sub> (mm): 0.010                      d<sub>50</sub> (mm): 0.076  
 d<sub>16</sub> (mm): 0.022                      d<sub>60</sub> (mm): 0.096  
 d<sub>30</sub> (mm): 0.045                      d<sub>84</sub> (mm): 0.18

Median Particle Diameter--d<sub>50</sub> (mm): 0.076  
 Uniformity Coefficient, Cu--[d<sub>60</sub>/d<sub>10</sub>] (mm): 9.6  
 Coefficient of Curvature, Cc--[d<sub>30</sub><sup>2</sup>/(d<sub>10</sub>\*d<sub>60</sub>)] (mm): 2.1  
 Mean Particle Diameter--[d<sub>16</sub>+d<sub>50</sub>+d<sub>84</sub>]/3 (mm): 0.093

Classification of fines (visual method): ML

ASTM Soil Classification: Silty sand (SM)  
 USDA Soil Classification: Sandy Loam

Laboratory analysis by: K. Wright  
 Data entered by: M. Vigil  
 Checked by: J. Hines



**Particle Size Analysis  
Hydrometer Data**

Job Name: Barr Engineering Company  
 Job Number: LB10.0170.00  
 Sample Number: As Received  
 Ring Number: NA  
 Depth: NA  
 Test Date: 18-Aug-10  
 Start Time: 9:12

Type of Water Used: DISTILLED  
 Reaction with H<sub>2</sub>O<sub>2</sub>: NA  
 Dispersant\*: (NaPO<sub>3</sub>)<sub>6</sub>  
 Measured particle density: 2.95  
 Initial Wt. (g): 46.39  
 Total Sample Wt. (g): 494.56  
 Wt. Passing #10 (g): 494.56

Date	Time (min)	Temp (°C)	R (g/L)	R <sub>L</sub> (g/L)	R <sub>corr</sub> (g/L)	L (cm)	D (mm)	P (%)	% Finer
18-Aug-10	1	21.8	20.5	6.0	14.5	12.9	0.04416	29.4	29.4
	2	21.8	16.5	6.0	10.5	13.6	0.03200	21.3	21.3
	5	21.8	13.5	6.0	7.5	14.1	0.02060	15.2	15.2
	15	21.8	12.0	6.0	6.0	14.3	0.01200	12.2	12.2
	30	21.8	10.0	6.0	4.0	14.7	0.00858	8.1	8.1
	60	21.9	10.0	6.0	4.0	14.7	0.00606	8.1	8.1
	120	22.0	9.0	6.0	3.0	14.8	0.00430	6.1	6.1
	250	22.0	9.0	6.0	3.0	14.8	0.00298	6.1	6.1
	440	22.0	9.0	6.0	3.0	14.8	0.00225	6.1	6.1
19-Aug-10	1425	21.8	8.5	6.0	2.5	14.9	0.00126	5.1	5.1

Comments:

\* Dispersion device: mechanically operated stirring device

Laboratory analysis by: K. Wright  
 Data entered by: M. Vigil  
 Checked by: J. Hines

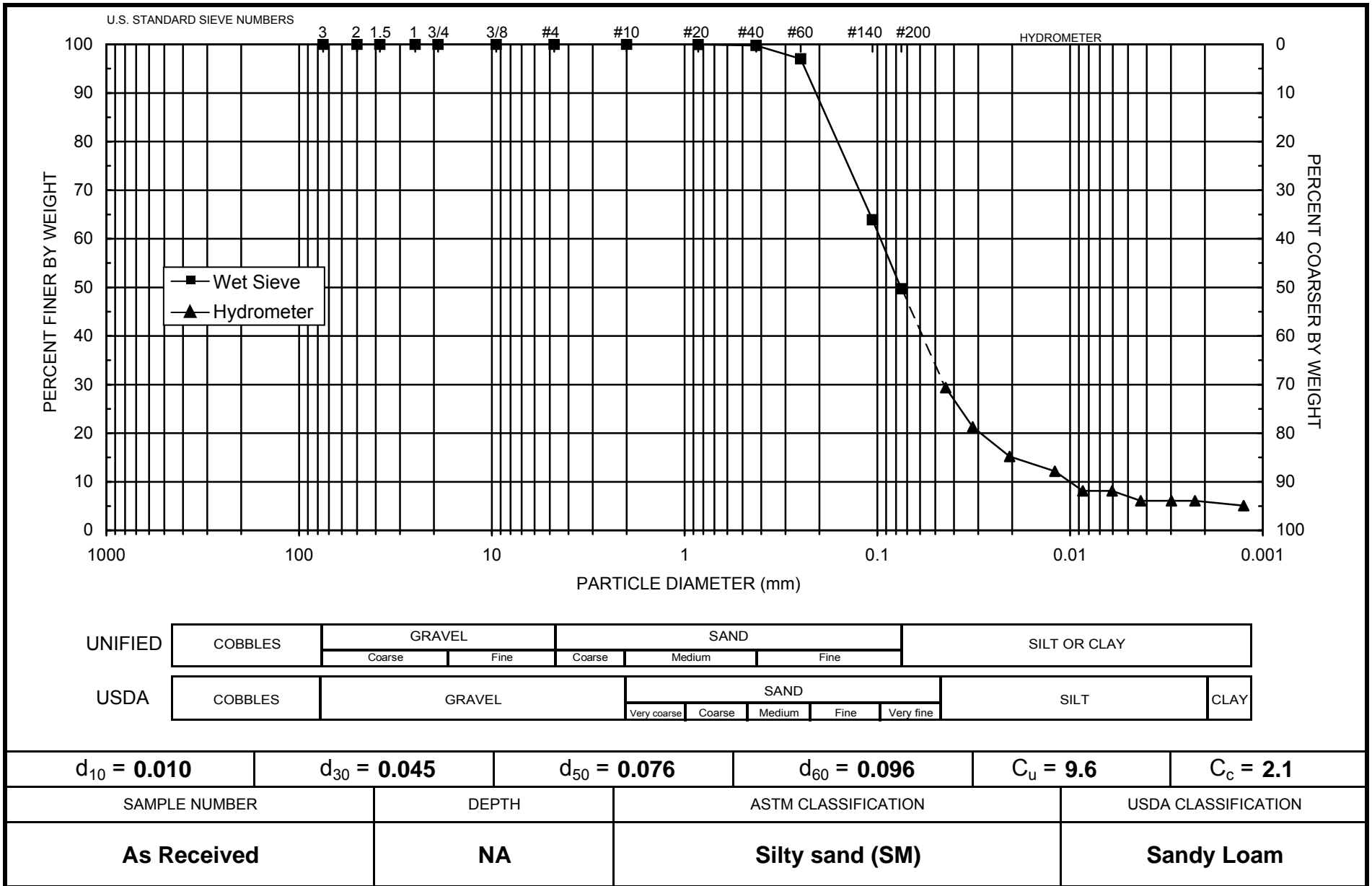

Daniel B. Stephens & Associates, Inc.



**Particle Size Analysis  
Wet Sieve Data (#10 Split)**

Job Name: Barr Engineering Company  
 Job Number: LB10.0170.00  
 Sample Number: Blend 1  
 Ring Number: NA  
 Depth: NA  
 Test Date: 7-Sep-10

Initial Dry Weight of Sample (g): 52.03  
 Weight Passing #10 (g): 52.03  
 Weight Retained #10 (g): 0.00  
 Weight of Hydrometer Sample (g): 52.03  
 Calculated Weight of Sieve Sample (g): 52.03  
 Shape: Angular  
 Hardness: Soft

Test Fraction	Sieve Number	Diameter (mm)	Wt. Retained	Cum Wt. Retained	Wt. Passing	% Passing	
+10	3"	75	0.00	0.00	52.03	100.00	
	2"	50	0.00	0.00	52.03	100.00	
	1.5"	38.1	0.00	0.00	52.03	100.00	
	1"	25	0.00	0.00	52.03	100.00	
	3/4"	19.0	0.00	0.00	52.03	100.00	
	3/8"	9.5	0.00	0.00	52.03	100.00	
	4	4.75	0.00	0.00	52.03	100.00	
	10	2.00	0.00	0.00	52.03	100.00	
-10	(Based on calculated sieve wt.)						
	20	0.85	0.00	0.00	52.03	100.00	
	40	0.425	0.03	0.03	52.00	99.94	
	60	0.250	0.80	0.83	51.20	98.40	
	140	0.106	7.87	8.70	43.33	83.28	
	200	0.075	3.24	11.94	40.09	77.05	
	dry pan			0.81	12.75	39.28	
	wet pan				39.28	0.00	

d<sub>10</sub> (mm): 0.0037      d<sub>50</sub> (mm): 0.037  
 d<sub>16</sub> (mm): 0.0072      d<sub>60</sub> (mm): 0.048  
 d<sub>30</sub> (mm): 0.017      d<sub>84</sub> (mm): 0.11

Median Particle Diameter--d<sub>50</sub> (mm): 0.037  
 Uniformity Coefficient, Cu--[d<sub>60</sub>/d<sub>10</sub>] (mm): 13  
 Coefficient of Curvature, Cc--[d<sub>30</sub><sup>2</sup>/(d<sub>10</sub>\*d<sub>60</sub>)] (mm): 1.6  
 Mean Particle Diameter--[d<sub>16</sub>+d<sub>50</sub>+d<sub>84</sub>]/3 (mm): 0.051

Classification of fines (visual method): ML

ASTM Soil Classification: Silt with sand (ML)s  
 USDA Soil Classification: Silt Loam

Laboratory analysis by: J. Ayarbe/M. Vigil  
 Data entered by: C. Krous  
 Checked by: J. Hines



**Particle Size Analysis  
Hydrometer Data**

Job Name: Barr Engineering Company  
 Job Number: LB10.0170.00  
 Sample Number: Blend 1  
 Ring Number: NA  
 Depth: NA  
 Test Date: 2-Sep-10  
 Start Time: 9:00

Type of Water Used: DISTILLED  
 Reaction with H<sub>2</sub>O<sub>2</sub>: NA  
 Dispersant\*: (NaPO<sub>3</sub>)<sub>6</sub>  
 Measured particle density: 2.99  
 Initial Wt. (g): 52.03  
 Total Sample Wt. (g): 52.03  
 Wt. Passing #10 (g): 52.03

Date	Time (min)	Temp (°C)	R (g/L)	R <sub>L</sub> (g/L)	R <sub>corr</sub> (g/L)	L (cm)	D (mm)	P (%)	% Finer
2-Sep-10	1	21.7	35.0	6.0	29.0	10.6	0.03951	52.4	52.4
	2	21.7	28.5	6.0	22.5	11.6	0.02931	40.6	40.6
	5	21.7	23.5	6.0	17.5	12.4	0.01918	31.6	31.6
	15	21.7	18.5	6.0	12.5	13.3	0.01143	22.6	22.6
	30	21.7	16.0	6.0	10.0	13.7	0.00821	18.1	18.1
	60	21.9	13.0	6.0	7.0	14.2	0.00589	12.6	12.6
	120	22.0	12.0	6.0	6.0	14.3	0.00419	10.8	10.8
	250	22.0	10.5	6.0	4.5	14.6	0.00293	8.1	8.1
	450	22.1	10.0	6.0	4.0	14.7	0.00218	7.2	7.2
3-Sep-10	1410	21.7	9.5	6.0	3.5	14.7	0.00124	6.3	6.3

Comments:

\* Dispersion device: mechanically operated stirring device

Laboratory analysis by: K. Wright  
 Data entered by: C. Krous  
 Checked by: J. Hines



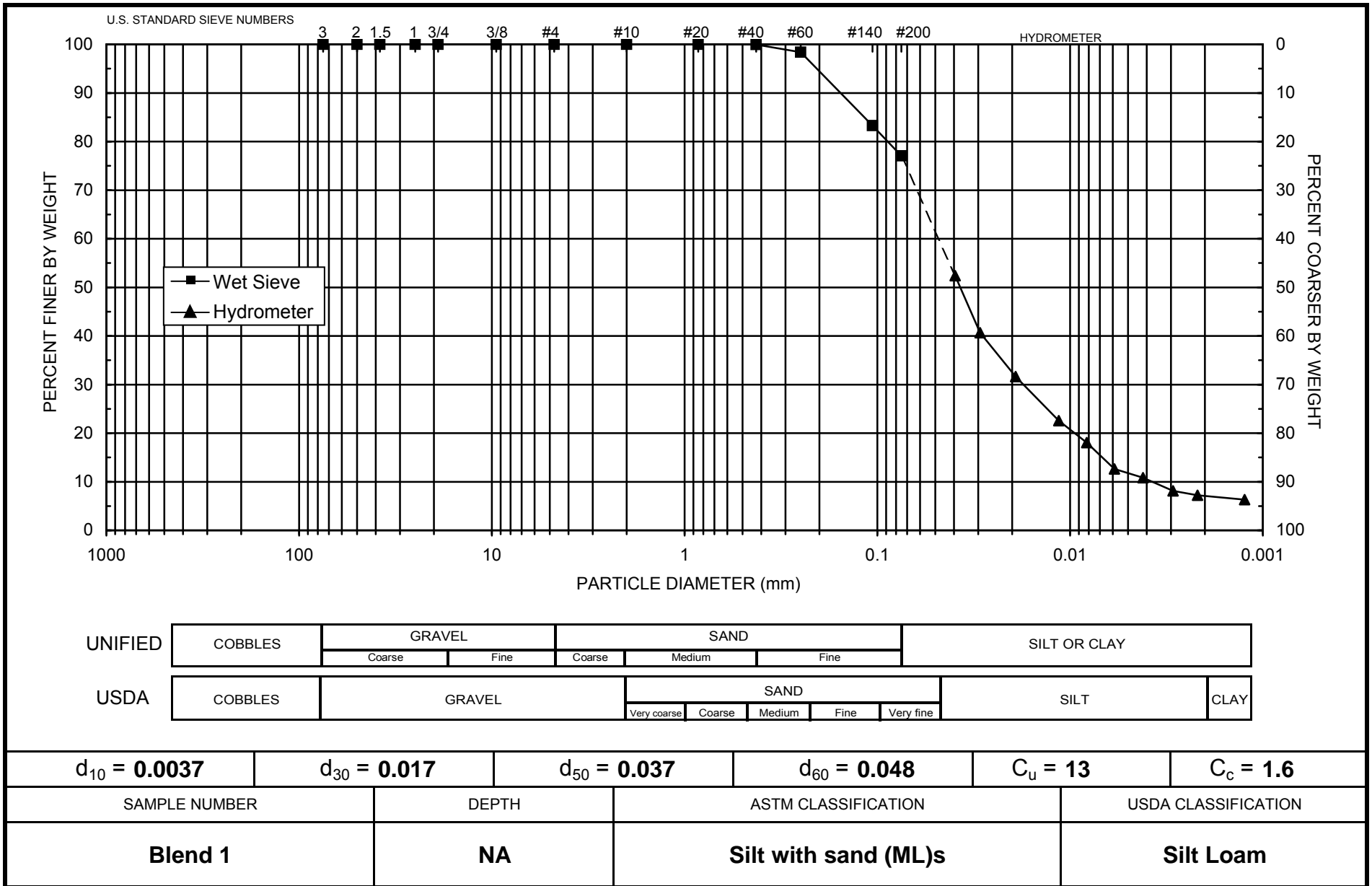

Daniel B. Stephens & Associates, Inc.



**Particle Size Analysis  
Wet Sieve Data (#10 Split)**

Job Name: Barr Engineering Company  
 Job Number: LB10.0170.00  
 Sample Number: Blend 2  
 Ring Number: NA  
 Depth: NA  
 Test Date: 7-Sep-10

Initial Dry Weight of Sample (g): 49.18  
 Weight Passing #10 (g): 49.18  
 Weight Retained #10 (g): 0.00  
 Weight of Hydrometer Sample (g): 49.18  
 Calculated Weight of Sieve Sample (g): 49.18  
 Shape: Angular  
 Hardness: Soft

Test Fraction	Sieve Number	Diameter (mm)	Wt. Retained	Cum Wt. Retained	Wt. Passing	% Passing
+10	3"	75	0.00	0.00	49.18	100.00
	2"	50	0.00	0.00	49.18	100.00
	1.5"	38.1	0.00	0.00	49.18	100.00
	1"	25	0.00	0.00	49.18	100.00
	3/4"	19.0	0.00	0.00	49.18	100.00
	3/8"	9.5	0.00	0.00	49.18	100.00
	4	4.75	0.00	0.00	49.18	100.00
	10	2.00	0.00	0.00	49.18	100.00
-10	(Based on calculated sieve wt.)					
	20	0.85	0.00	0.00	49.18	100.00
	40	0.425	0.07	0.07	49.11	99.86
	60	0.250	1.14	1.21	47.97	97.54
	140	0.106	13.86	15.07	34.11	69.36
	200	0.075	6.34	21.41	27.77	56.47
	dry pan			2.08	23.49	25.69
wet pan				25.69	0.00	

d<sub>10</sub> (mm): 0.0056      d<sub>50</sub> (mm): 0.062  
 d<sub>16</sub> (mm): 0.012      d<sub>60</sub> (mm): 0.082  
 d<sub>30</sub> (mm): 0.032      d<sub>84</sub> (mm): 0.17

Median Particle Diameter--d<sub>50</sub> (mm): 0.062  
 Uniformity Coefficient, Cu--[d<sub>60</sub>/d<sub>10</sub>] (mm): 15  
 Coefficient of Curvature, Cc--[d<sub>30</sub><sup>2</sup>/(d<sub>10</sub>\*d<sub>60</sub>)] (mm): 2.2  
 Mean Particle Diameter--[d<sub>16</sub>+d<sub>50</sub>+d<sub>84</sub>]/3 (mm): 0.081

Classification of fines (visual method): ML

ASTM Soil Classification: Sandy silt s(ML)  
 USDA Soil Classification: Sandy Loam

Laboratory analysis by: D. O'Dowd/M. Vigil  
 Data entered by: C. Krous  
 Checked by: J. Hines



**Particle Size Analysis  
Hydrometer Data**

Job Name: Barr Engineering Company  
 Job Number: LB10.0170.00  
 Sample Number: Blend 2  
 Ring Number: NA  
 Depth: NA  
 Test Date: 2-Sep-10  
 Start Time: 9:06

Type of Water Used: DISTILLED  
 Reaction with H<sub>2</sub>O<sub>2</sub>: NA  
 Dispersant\*: (NaPO<sub>3</sub>)<sub>6</sub>  
 Measured particle density: 2.98  
 Initial Wt. (g): 49.18  
 Total Sample Wt. (g): 49.18  
 Wt. Passing #10 (g): 49.18

Date	Time (min)	Temp (°C)	R (g/L)	R <sub>L</sub> (g/L)	R <sub>corr</sub> (g/L)	L (cm)	D (mm)	P (%)	% Finer
2-Sep-10	1	21.7	25.5	6.0	19.5	12.1	0.04237	37.3	37.3
	2	21.7	21.0	6.0	15.0	12.9	0.03086	28.7	28.7
	5	21.7	17.5	6.0	11.5	13.4	0.01995	22.0	22.0
	15	21.7	14.0	6.0	8.0	14.0	0.01176	15.3	15.3
	30	21.8	12.5	6.0	6.5	14.3	0.00838	12.4	12.4
	60	21.9	11.5	6.0	5.5	14.4	0.00595	10.5	10.5
	120	22.0	10.0	6.0	4.0	14.7	0.00424	7.6	7.6
	250	22.0	9.5	6.0	3.5	14.7	0.00295	6.7	6.7
	445	22.1	9.0	6.0	3.0	14.8	0.00221	5.7	5.7
3-Sep-10	1405	21.7	8.0	6.0	2.0	15.0	0.00126	3.8	3.8

Comments:

\* Dispersion device: mechanically operated stirring device

Laboratory analysis by: K. Wright  
 Data entered by: C. Krous  
 Checked by: J. Hines





**Particle Size Analysis  
Wet Sieve Data (#10 Split)**

Job Name: Barr Engineering Company  
 Job Number: LB10.0170.00  
 Sample Number: Blend 3  
 Ring Number: NA  
 Depth: NA  
 Test Date: 7-Sep-10

Initial Dry Weight of Sample (g): 50.11  
 Weight Passing #10 (g): 50.11  
 Weight Retained #10 (g): 0.00  
 Weight of Hydrometer Sample (g): 50.11  
 Calculated Weight of Sieve Sample (g): 50.11  
 Shape: Angular  
 Hardness: Soft

Test Fraction	Sieve Number	Diameter (mm)	Wt. Retained	Cum Wt. Retained	Wt. Passing	% Passing
+10	3"	75	0.00	0.00	50.11	100.00
	2"	50	0.00	0.00	50.11	100.00
	1.5"	38.1	0.00	0.00	50.11	100.00
	1"	25	0.00	0.00	50.11	100.00
	3/4"	19.0	0.00	0.00	50.11	100.00
	3/8"	9.5	0.00	0.00	50.11	100.00
	4	4.75	0.00	0.00	50.11	100.00
	10	2.00	0.00	0.00	50.11	100.00
-10	(Based on calculated sieve wt.)					
	20	0.85	0.00	0.00	50.11	100.00
	40	0.425	0.07	0.07	50.04	99.86
	60	0.250	1.53	1.60	48.51	96.81
	140	0.106	19.33	20.93	29.18	58.23
	200	0.075	10.46	31.39	18.72	37.36
	dry pan			2.16	33.55	16.56
wet pan				16.56	0.00	

d<sub>10</sub> (mm): 0.013                      d<sub>50</sub> (mm): 0.092  
 d<sub>16</sub> (mm): 0.028                      d<sub>60</sub> (mm): 0.11  
 d<sub>30</sub> (mm): 0.058                      d<sub>84</sub> (mm): 0.19

Median Particle Diameter--d<sub>50</sub> (mm): 0.092  
 Uniformity Coefficient, Cu--[d<sub>60</sub>/d<sub>10</sub>] (mm): 8.5  
 Coefficient of Curvature, Cc--[d<sub>30</sub><sup>2</sup>/(d<sub>10</sub>\*d<sub>60</sub>)] (mm): 2.4  
 Mean Particle Diameter--[d<sub>16</sub>+d<sub>50</sub>+d<sub>84</sub>]/3 (mm): 0.10

Classification of fines (visual method): ML

ASTM Soil Classification: Silty sand (SM)  
 USDA Soil Classification: Loamy Sand

Laboratory analysis by: D. O'Dowd/M. Vigil  
 Data entered by: C. Krous  
 Checked by: J. Hines



**Particle Size Analysis  
Hydrometer Data**

Job Name: Barr Engineering Company  
 Job Number: LB10.0170.00  
 Sample Number: Blend 3  
 Ring Number: NA  
 Depth: NA  
 Test Date: 2-Sep-10  
 Start Time: 9:12

Type of Water Used: DISTILLED  
 Reaction with H<sub>2</sub>O<sub>2</sub>: NA  
 Dispersant\*: (NaPO<sub>3</sub>)<sub>6</sub>  
 Measured particle density: 2.98  
 Initial Wt. (g): 50.11  
 Total Sample Wt. (g): 50.11  
 Wt. Passing #10 (g): 50.11

Date	Time (min)	Temp (°C)	R (g/L)	R <sub>L</sub> (g/L)	R <sub>corr</sub> (g/L)	L (cm)	D (mm)	P (%)	% Finer
2-Sep-10	1	21.7	18.0	6.0	12.0	13.3	0.04452	22.5	22.5
	2	21.7	15.5	6.0	9.5	13.8	0.03196	17.8	17.8
	5	21.7	12.5	6.0	6.5	14.3	0.02057	12.2	12.2
	15	21.7	11.0	6.0	5.0	14.5	0.01198	9.4	9.4
	30	21.8	10.5	6.0	4.5	14.6	0.00848	8.4	8.4
	60	21.9	10.0	6.0	4.0	14.7	0.00601	7.5	7.5
	120	22.0	9.0	6.0	3.0	14.8	0.00427	5.6	5.6
	250	22.0	8.0	6.0	2.0	15.0	0.00297	3.8	3.8
	440	22.1	8.0	6.0	2.0	15.0	0.00224	3.8	3.8
3-Sep-10	1400	21.7	7.0	6.0	1.0	15.2	0.00127	1.9	1.9

Comments:

\* Dispersion device: mechanically operated stirring device

Laboratory analysis by: K. Wright  
 Data entered by: C. Krous  
 Checked by: J. Hines

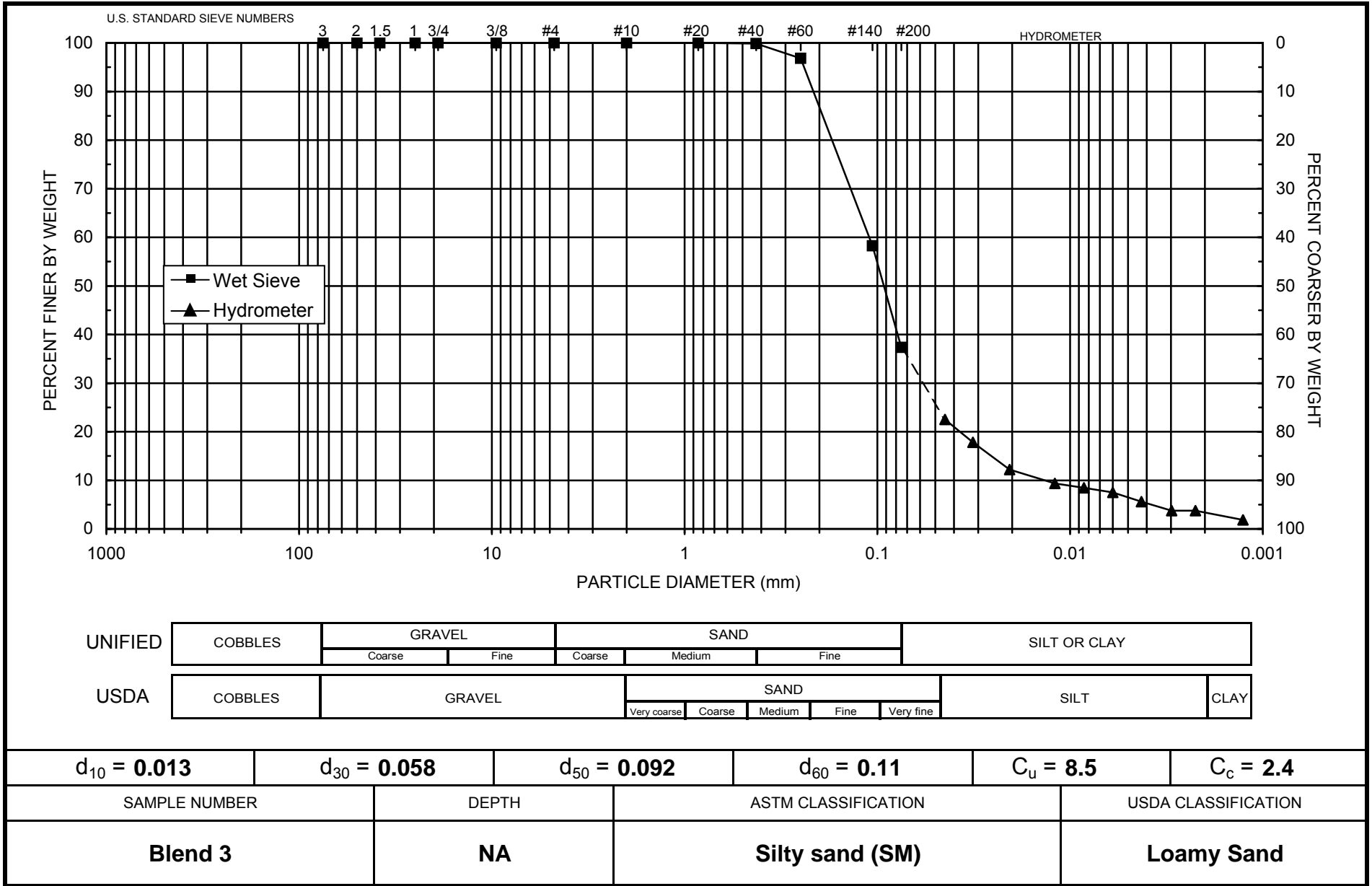

Daniel B. Stephens & Associates, Inc.



**Particle Size Analysis  
Wet Sieve Data (#10 Split)**

Job Name: Barr Engineering Company  
 Job Number: LB10.0170.00  
 Sample Number: Blend 4  
 Ring Number: NA  
 Depth: NA  
 Test Date: 7-Sep-10

Initial Dry Weight of Sample (g): 56.56  
 Weight Passing #10 (g): 56.56  
 Weight Retained #10 (g): 0.00  
 Weight of Hydrometer Sample (g): 56.56  
 Calculated Weight of Sieve Sample (g): 56.56  
 Shape: Angular  
 Hardness: Soft

Test Fraction	Sieve Number	Diameter (mm)	Wt. Retained	Cum Wt. Retained	Wt. Passing	% Passing
+10	3"	75	0.00	0.00	56.56	100.00
	2"	50	0.00	0.00	56.56	100.00
	1.5"	38.1	0.00	0.00	56.56	100.00
	1"	25	0.00	0.00	56.56	100.00
	3/4"	19.0	0.00	0.00	56.56	100.00
	3/8"	9.5	0.00	0.00	56.56	100.00
	4	4.75	0.00	0.00	56.56	100.00
-10	10	2.00	0.00	0.00	56.56	100.00
	(Based on calculated sieve wt.)					
	20	0.85	0.00	0.00	56.56	100.00
	40	0.425	0.08	0.08	56.48	99.86
	60	0.250	2.43	2.51	54.05	95.56
	140	0.106	28.06	30.57	25.99	45.95
	200	0.075	13.88	44.45	12.11	21.41
dry pan			4.05	48.50	8.06	
wet pan				8.06	0.00	

d<sub>10</sub> (mm): 0.051                      d<sub>50</sub> (mm): 0.11  
 d<sub>16</sub> (mm): 0.062                      d<sub>60</sub> (mm): 0.14  
 d<sub>30</sub> (mm): 0.085                      d<sub>84</sub> (mm): 0.20

Median Particle Diameter--d<sub>50</sub> (mm): 0.11  
 Uniformity Coefficient, Cu--[d<sub>60</sub>/d<sub>10</sub>] (mm): 2.7  
 Coefficient of Curvature, Cc--[d<sub>30</sub><sup>2</sup>/(d<sub>10</sub>\*d<sub>60</sub>)] (mm): 1.0  
 Mean Particle Diameter--[d<sub>16</sub>+d<sub>50</sub>+d<sub>84</sub>]/3 (mm): 0.12

Classification of fines (visual method): ML

ASTM Soil Classification: Silty sand (SM)  
 USDA Soil Classification: Sand

Laboratory analysis by: K. Wright  
 Data entered by: C. Krous  
 Checked by: J. Hines





**Particle Size Analysis  
Hydrometer Data**

Job Name: Barr Engineering Company  
 Job Number: LB10.0170.00  
 Sample Number: Blend 4  
 Ring Number: NA  
 Depth: NA  
 Test Date: 2-Sep-10  
 Start Time: 9:18

Type of Water Used: DISTILLED  
 Reaction with H<sub>2</sub>O<sub>2</sub>: NA  
 Dispersant\*: (NaPO<sub>3</sub>)<sub>6</sub>  
 Measured particle density: 2.97  
 Initial Wt. (g): 56.56  
 Total Sample Wt. (g): 56.56  
 Wt. Passing #10 (g): 56.56

Date	Time (min)	Temp (°C)	R (g/L)	R <sub>L</sub> (g/L)	R <sub>corr</sub> (g/L)	L (cm)	D (mm)	P (%)	% Finer
2-Sep-10	1	21.7	10.5	6.0	4.5	14.6	0.04657	7.5	7.5
	2	21.7	10.0	6.0	4.0	14.7	0.03303	6.6	6.6
	5	21.7	9.0	6.0	3.0	14.8	0.02100	5.0	5.0
	15	21.7	8.5	6.0	2.5	14.9	0.01216	4.2	4.2
	30	21.8	8.0	6.0	2.0	15.0	0.00861	3.3	3.3
	60	21.9	8.0	6.0	2.0	15.0	0.00608	3.3	3.3
	120	22.0	7.5	6.0	1.5	15.1	0.00431	2.5	2.5
	250	22.0	7.5	6.0	1.5	15.1	0.00298	2.5	2.5
	436	22.1	7.5	6.0	1.5	15.1	0.00226	2.5	2.5
3-Sep-10	1395	21.7	6.5	6.0	0.5	15.2	0.00127	0.8	0.8

Comments:

\* Dispersion device: mechanically operated stirring device

Laboratory analysis by: K. Wright  
 Data entered by: C. Krous  
 Checked by: J. Hines

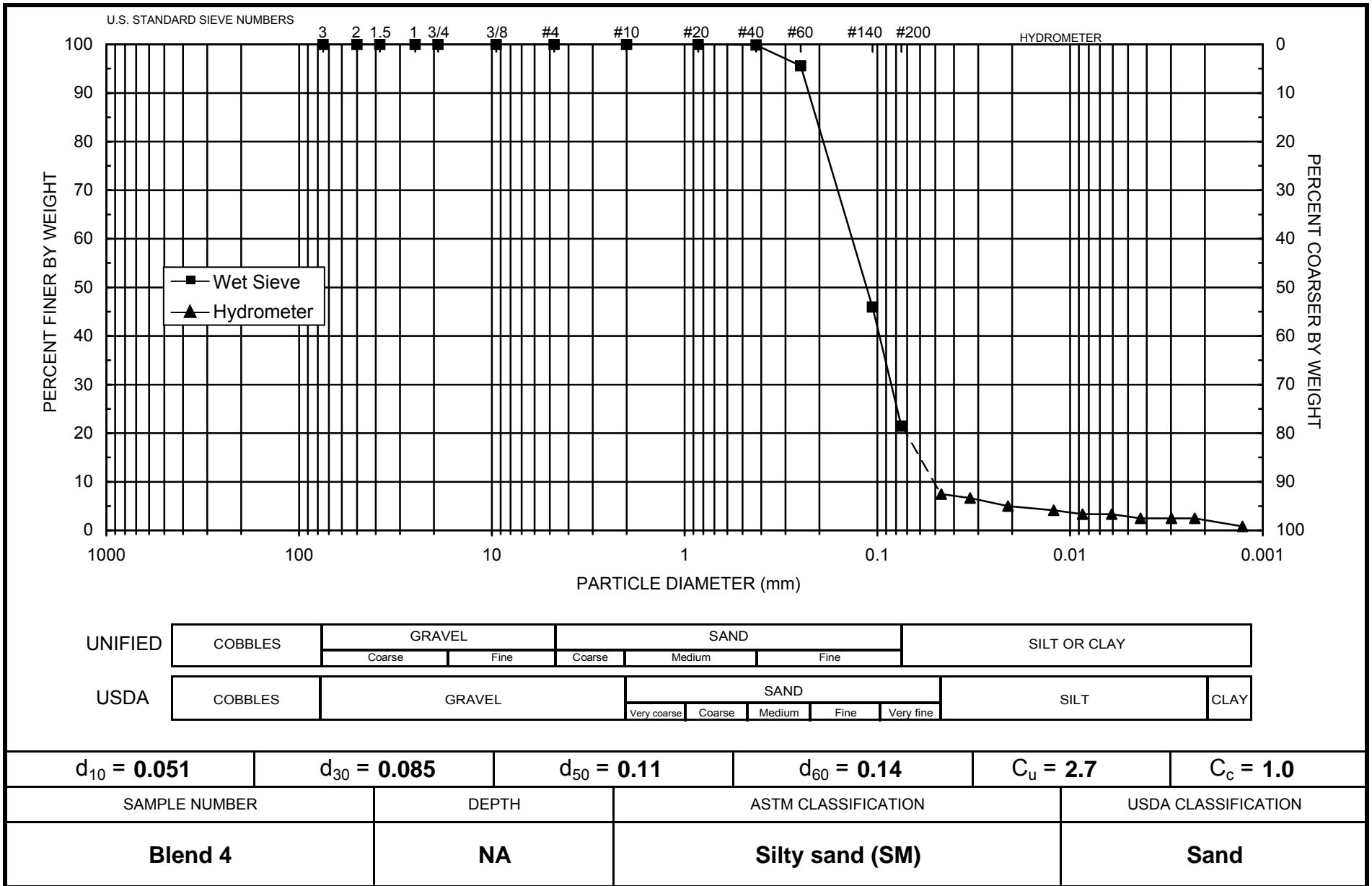

Daniel B. Stephens & Associates, Inc.

## **Specific Gravity**



### Summary of Specific Gravity Tests

Sample Number	<4.75mm Material		>4.75mm Material		Bulk Sample
	Specific Gravity	Percent of Bulk Sample	Specific Gravity	Percent of Bulk Sample	Specific Gravity
-200 fraction #1	3.01	100.0	---	0.0	3.01
-200 fraction #2	2.99	100.0	---	0.0	2.99
-200 Average	3.00	100.0	---	0.0	3.00
+200 fraction #1	2.97	100.0	---	0.0	2.97
+200 fraction #2	2.98	100.0	---	0.0	2.98
+200 Average	2.98	100.0	---	0.0	2.98
As Received	2.95	100.0	---	0.0	2.95

--- = Unnecessary since specified fraction <5% of composite mass

\* = Based on specific gravity of material < 4.75 mm



**Data for Specific Gravity for Sample:  
-200 fraction #1**

Job Name: Barr Engineering Company  
 Job Number: LB10.0170.00  
 Sample Number: -200 fraction #1  
 Ring Number: NA  
 Depth: NA

**ASTM D854 (<4.75mm Fraction)**

	Test Date:	22-Aug-10	
	Percent of Test Sample (% g/g):	100.00	
	Percent of Bulk Sample (% g/g):	100.00	
		Trial 1	Trial 2
	Weight of pycnometer filled w/air (g):	93.43	90.54
	Weight of pycnometer filled w/soil (g):	143.35	141.09
	Weight of pycnometer filled w/soil & water (g):	375.91	373.59
	Weight of pycnometer filled w/water (g):	342.57	339.86
	Observed temperature (°C):	22.30	22.30
	Density of water at observed temperature (g/cm <sup>3</sup> ):	0.9977	0.9977
	Specific Gravity (g/g):	3.01	3.01
	Correction factor, K:	0.9995	0.9995
	Specific Gravity at 20°C (g/g):	3.01	3.00
	Average Specific Gravity at 20°C (g/g):	3.01	
	Average Particle Density at 20°C (g/cm <sup>3</sup> ):	3.00	

**ASTM C127 (>4.75mm Fraction)**

	Test Date:	---	
	Percent of Test Sample (% g/g):	0.00	
	Percent of Bulk Sample (% g/g):	0.00	
	Tare Weight (g):	---	
	Saturated Surface Dry (SSD) mass in Air & Tare (g):	---	
	Saturated Apparent mass in Water & Tare (g):	---	
	Oven Dry (OD) mass in Air & Tare (g):	---	
	Observed Temperature (°C):	---	
	Density of water at observed temperature (g/m <sup>3</sup> ):	---	
	SSD Specific Gravity (g/g):	---	
	Apparent Specific Gravity (g/g):	---	
	OD Specific Gravity (g/g):	---	
	Percent Absorption (%):	---	
	Correction Factor, K:	---	
	Average Specific Gravity (Apparent) at 20°C*:	---	
	Average Particle Density (Apparent) at 20°C (g/cm <sup>3</sup> )*:	---	

--- = Test unnecessary since specified fraction <5% of composite mass.

**Specific Gravity (Apparent) at 20°C\*:** 3.01  
**Particle Density (Apparent) at 20°C (g/cm<sup>3</sup>)\*:** 3.00

\* Weighted harmonic average, if more than one fraction used.

Laboratory analysis by: K. Wright  
 Data entered by: C. Krous  
 Checked by: J. Hines



**Data for Specific Gravity for Sample:  
-200 fraction #2**

Job Name: Barr Engineering Company  
 Job Number: LB10.0170.00  
 Sample Number: -200 fraction #2  
 Ring Number: NA  
 Depth: NA

**ASTM D854 (<4.75mm Fraction)**

	Test Date:	22-Aug-10	
Percent of Test Sample (% g/g):		100.00	
Percent of Bulk Sample (% g/g):		100.00	
		Trial 1	Trial 2
Weight of pycnometer filled w/air (g):		90.62	90.89
Weight of pycnometer filled w/soil (g):		140.55	140.93
Weight of pycnometer filled w/soil & water (g):		373.07	373.53
Weight of pycnometer filled w/water (g):		339.85	340.17
Observed temperature (°C):		22.40	22.30
Density of water at observed temperature (g/cm <sup>3</sup> ):		0.9977	0.9977
Specific Gravity (g/g):		2.99	3.00
Correction factor, K:		0.9995	0.9995
Specific Gravity at 20°C (g/g):		2.99	3.00
Average Specific Gravity at 20°C (g/g):		2.99	
Average Particle Density at 20°C (g/cm <sup>3</sup> ):		2.99	

**ASTM C127 (>4.75mm Fraction)**

	Test Date:	---	
Percent of Test Sample (% g/g):		0.00	
Percent of Bulk Sample (% g/g):		0.00	
Tare Weight (g):		---	
Saturated Surface Dry (SSD) mass in Air & Tare (g):		---	
Saturated Apparent mass in Water & Tare (g):		---	
Oven Dry (OD) mass in Air & Tare (g):		---	
Observed Temperature (°C):		---	
Density of water at observed temperature (g/m <sup>3</sup> ):		---	
SSD Specific Gravity (g/g):		---	
Apparent Specific Gravity (g/g):		---	
OD Specific Gravity (g/g):		---	
Percent Absorption (%):		---	
Correction Factor, K:		---	
Average Specific Gravity (Apparent) at 20°C*:		---	
Average Particle Density (Apparent) at 20°C (g/cm <sup>3</sup> )*:		---	

--- = Test unnecessary since specified fraction <5% of composite mass.

**Specific Gravity (Apparent) at 20°C\*:** 2.99  
**Particle Density (Apparent) at 20°C (g/cm<sup>3</sup>)\*:** 2.99

\* Weighted harmonic average, if more than one fraction used.

Laboratory analysis by: K. Wright  
 Data entered by: C. Krous  
 Checked by: J. Hines



**Data for Specific Gravity for Sample:  
+200 fraction #1**

Job Name: Barr Engineering Company  
 Job Number: LB10.0170.00  
 Sample Number: +200 fraction #1  
 Ring Number: NA  
 Depth: NA

**ASTM D854 (<4.75mm Fraction)**

	Test Date:	22-Aug-10	
	Percent of Test Sample (% g/g):	100.00	
	Percent of Bulk Sample (% g/g):	100.00	
		Trial 1	Trial 2
	Weight of pycnometer filled w/air (g):	93.08	92.48
	Weight of pycnometer filled w/soil (g):	147.04	142.89
	Weight of pycnometer filled w/soil & water (g):	378.14	375.28
	Weight of pycnometer filled w/water (g):	342.32	341.82
	Observed temperature (°C):	22.20	22.20
	Density of water at observed temperature (g/cm <sup>3</sup> ):	0.9977	0.9977
	Specific Gravity (g/g):	2.98	2.97
	Correction factor, K:	0.9995	0.9995
	Specific Gravity at 20°C (g/g):	2.97	2.97
	Average Specific Gravity at 20°C (g/g):	2.97	
	Average Particle Density at 20°C (g/cm <sup>3</sup> ):	2.97	

**ASTM C127 (>4.75mm Fraction)**

	Test Date:	---	
	Percent of Test Sample (% g/g):	0.00	
	Percent of Bulk Sample (% g/g):	0.00	
	Tare Weight (g):	---	
	Saturated Surface Dry (SSD) mass in Air & Tare (g):	---	
	Saturated Apparent mass in Water & Tare (g):	---	
	Oven Dry (OD) mass in Air & Tare (g):	---	
	Observed Temperature (°C):	---	
	Density of water at observed temperature (g/m <sup>3</sup> ):	---	
	SSD Specific Gravity (g/g):	---	
	Apparent Specific Gravity (g/g):	---	
	OD Specific Gravity (g/g):	---	
	Percent Absorption (%):	---	
	Correction Factor, K:	---	
	Average Specific Gravity (Apparent) at 20°C*:	---	
	Average Particle Density (Apparent) at 20°C (g/cm <sup>3</sup> )*:	---	

--- = Test unnecessary since specified fraction <5% of composite mass.

**Specific Gravity (Apparent) at 20°C\*:** 2.97  
**Particle Density (Apparent) at 20°C (g/cm<sup>3</sup>)\*:** 2.97

\* Weighted harmonic average, if more than one fraction used.

Laboratory analysis by: K. Wright  
 Data entered by: C. Krous  
 Checked by: J. Hines



**Data for Specific Gravity for Sample:  
+200 fraction #2**

Job Name: Barr Engineering Company  
 Job Number: LB10.0170.00  
 Sample Number: +200 fraction #2  
 Ring Number: NA  
 Depth: NA

**ASTM D854 (<4.75mm Fraction)**

	Test Date:	22-Aug-10	
Percent of Test Sample (% g/g):		100.00	
Percent of Bulk Sample (% g/g):		100.00	
		Trial 1	Trial 2
Weight of pycnometer filled w/air (g):		93.36	90.53
Weight of pycnometer filled w/soil (g):		145.05	141.06
Weight of pycnometer filled w/soil & water (g):		376.92	373.33
Weight of pycnometer filled w/water (g):		342.53	339.82
Observed temperature (°C):		22.30	22.20
Density of water at observed temperature (g/cm <sup>3</sup> ):		0.9977	0.9977
Specific Gravity (g/g):		2.99	2.97
Correction factor, K:		0.9995	0.9995
Specific Gravity at 20°C (g/g):		2.99	2.97
Average Specific Gravity at 20°C (g/g):		2.98	
Average Particle Density at 20°C (g/cm <sup>3</sup> ):		2.97	

**ASTM C127 (>4.75mm Fraction)**

	Test Date:	---	
Percent of Test Sample (% g/g):		0.00	
Percent of Bulk Sample (% g/g):		0.00	
Tare Weight (g):		---	
Saturated Surface Dry (SSD) mass in Air & Tare (g):		---	
Saturated Apparent mass in Water & Tare (g):		---	
Oven Dry (OD) mass in Air & Tare (g):		---	
Observed Temperature (°C):		---	
Density of water at observed temperature (g/m <sup>3</sup> ):		---	
SSD Specific Gravity (g/g):		---	
Apparent Specific Gravity (g/g):		---	
OD Specific Gravity (g/g):		---	
Percent Absorption (%):		---	
Correction Factor, K:		---	
Average Specific Gravity (Apparent) at 20°C*:		---	
Average Particle Density (Apparent) at 20°C (g/cm <sup>3</sup> )*:		---	

--- = Test unnecessary since specified fraction <5% of composite mass.

**Specific Gravity (Apparent) at 20°C\*:** 2.98  
**Particle Density (Apparent) at 20°C (g/cm<sup>3</sup>)\*:** 2.97

\* Weighted harmonic average, if more than one fraction used.

Laboratory analysis by: K. Wright  
 Data entered by: C. Krous  
 Checked by: J. Hines





**Data for Specific Gravity for Sample:  
As Received**

Job Name: Barr Engineering Company  
 Job Number: LB10.0170.00  
 Sample Number: As Received  
 Ring Number: NA  
 Depth: NA

**ASTM D854 (<4.75mm Fraction)**

	Test Date:	17-Aug-10	
	Percent of Test Sample (% g/g):	100.00	
	Percent of Bulk Sample (% g/g):	100.00	
		<i>Trial 1</i>	<i>Trial 2</i>
	Weight of pycnometer filled w/air (g):	92.14	92.00
	Weight of pycnometer filled w/soil (g):	144.17	145.97
	Weight of pycnometer filled w/soil & water (g):	375.81	376.91
	Weight of pycnometer filled w/water (g):	341.39	341.23
	Observed temperature (°C):	22.00	22.00
	Density of water at observed temperature (g/cm <sup>3</sup> ):	0.9978	0.9978
	Specific Gravity (g/g):	2.95	2.95
	Correction factor, K:	0.9996	0.9996
	Specific Gravity at 20°C (g/g):	2.95	2.95
	Average Specific Gravity at 20°C (g/g):	2.95	
	Average Particle Density at 20°C (g/cm <sup>3</sup> ):	2.95	

**ASTM C127 (>4.75mm Fraction)**

	Test Date:	---	
	Percent of Test Sample (% g/g):	0.00	
	Percent of Bulk Sample (% g/g):	0.00	
	Tare Weight (g):	---	
	Saturated Surface Dry (SSD) mass in Air & Tare (g):	---	
	Saturated Apparent mass in Water & Tare (g):	---	
	Oven Dry (OD) mass in Air & Tare (g):	---	
	Observed Temperature (°C):	---	
	Density of water at observed temperature (g/m <sup>3</sup> ):	---	
	SSD Specific Gravity (g/g):	---	
	Apparent Specific Gravity (g/g):	---	
	OD Specific Gravity (g/g):	---	
	Percent Absorption (%):	---	
	Correction Factor, K:	---	
	Average Specific Gravity (Apparent) at 20°C*:	---	
	Average Particle Density (Apparent) at 20°C (g/cm <sup>3</sup> )*:	---	

--- = Test unnecessary since specified fraction <5% of composite mass.

**Specific Gravity (Apparent) at 20°C\*:** 2.95  
**Particle Density (Apparent) at 20°C (g/cm<sup>3</sup>)\* :** 2.95

\* Weighted harmonic average, if more than one fraction used.

Laboratory analysis by: K. Wright  
 Data entered by: C. Krous  
 Checked by: J. Hines

# Laboratory Tests and Methods



## Tests and Methods

Dry Bulk Density:	ASTM D7263
Moisture Content:	ASTM D7263
Calculated Porosity:	ASTM D7263
Saturated Hydraulic Conductivity:	
Constant Head: (Rigid Wall)	ASTM D 2434 (modified apparatus)
Hanging Column Method:	ASTM D6836 (modified apparatus)
Pressure Plate Method:	ASTM D6836 (modified apparatus)
Water Potential (Dewpoint Potentiometer) Method:	ASTM D6836
Relative Humidity (Box) Method:	Karathanasis & Hajek. 1982. Quantitative Evaluation of Water Adsorption on Soil Clays. SSA Journal 46:1321-1325; Campbell, G. and G. Gee. 1986. Water Potential: Miscellaneous Methods. Chp. 25, pp. 631-632, in A. Klute (ed.), Methods of Soil Analysis, American Society of Agronomy, Madison, WI
Moisture Retention Characteristics & Calculated Unsaturated Hydraulic Conductivity:	ASTM D6836; van Genuchten, M.T. 1980. A closed-form equation for predicting the hydraulic conductivity of unsaturated soils. SSSAJ 44:892-898; van Genuchten, M.T., F.J. Leij, and S.R. Yates. 1991. The RETC code for quantifying the hydraulic functions of unsaturated soils. Robert S. Kerr Environmental Research Laboratory, Office of Research and Development, U.S. Environmental Protection Agency, Ada, Oklahoma. EPA/600/2091/065. December 1991
Specific Gravity Fine	ASTM D854
Particle Size Analysis:	ASTM D422